

# Pioneering Energy Solutions

## Solutions for renewable energies

Version 2025



**Weidmüller** 



# Pioneering Energy Solutions

## Solutions for renewable energies

---

### Pioneering Energy Solutions

#### Power generation

Wind energy

---

Photovoltaics

---

#### Power transmission and energy storage

Energy storage

---

Hydrogen

---

DC Microgrids

---

#### Software for energy applications

Energy management

---

---

### Appendix

#### Service and support

---

#### Index

Index Type / Index Order No.

---

# Pioneering energy solutions

## Efficient solutions for the energy transition

Smart Industrial Connectivity: Electrification, automation, digitalisation, electrical connectivity and renewable energies – markets in which Weidmüller is at home. Throughout its 175-year history, Weidmüller has been a pioneer in innovative products, supporting and promoting technological and social change. Sustainability is taking on an increasingly relevant role in this context. We support the change with our products and solutions for the energy transition.

## Power generation

---

### Wind energy

#### Maximum performance and availability of wind turbines

With many years of industry experience, Weidmüller is the expert for condition monitoring, digitalisation, lighting and connectivity for the wind industry. In addition to control cabinet components, we offer solutions for condition monitoring of rotor blades and screw connections, complete LED systems for the tower, nacelle and hub, as well as customised housing solutions.



### Photovoltaics

#### Efficient installation and operation of photovoltaics

Weidmüller offers a wide range of combiner boxes, monitoring solutions and components for ground-mounted photovoltaic systems and rooftop systems to meet your individual requirements: Benefit from our many years of experience in the photovoltaic industry, the know-how of our experts and our global network.

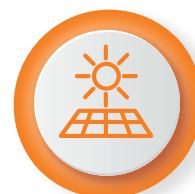

## Power transmission and energy storage

---

### Energy storage systems

#### Solutions and products for battery energy storage systems (BESS)

The storage of renewable energy contributes significantly to the optimal use of this future-oriented energy source. With our industrial connectivity and digitalisation solutions, we offer an extensive range of solutions for energy storage systems. Be it for battery management, power back-up, connectivity or Ethernet communication.



### Hydrogen

#### Sustainable transformation of energy and industrial processes

Weidmüller offers customer-specific solutions for the digitalisation and monitoring of your hydrogen plant, from electrolyzers to fuel cells and hydrogen refuelling stations. Rely on precise stack monitoring, safe automation and certified connectivity to make your processes more efficient and secure.

With our products and extensive experience, we actively support the process industry in developing and building sustainable solutions for hydrogen production. We place a special focus on modularisation to ensure a fast and successful ramp-up of the hydrogen industry.



### DC Microgrids

The use of direct current technology in industrial plants makes an important contribution to the energy transition and will become the new standard in the years to come. This is because a DC-based microgrid achieves not only a much higher level of energy efficiency, but also greater grid quality and security of supply. As a pioneer in the research and development of DC technology, we already offer an extensive range of DC ready solutions and components.



## Software for energy applications

---

### Energy management

With the flexible software solutions from Weidmüller GTI Software, you can keep an eye on energy consumption and production processes at all times. Complex processes are easily visualised, energy consumption is transparently monitored and production processes are efficiently managed – ideal for production environments with numerous sensors and actuators. Whether resource and energy management, IIoT software or HMI/SCADA: our software solutions can be easily integrated into existing systems and flexibly combined – for well-founded decisions and stable processes.



# Wind energy

<b>Wind energy</b>	Introduction	A.2
	BLADEcontrol® rotor blade monitoring	A.6
	BOLTcontrol bolt breakage detection	A.12
	TwinCap® condition monitoring for blade bearings	A.14
	High-performance components for wind turbines	A.18
	Customised solutions	A.50
	Success story: Lanthan Safe Sky	A.52
	Success story: Caribbean flair for BLADEcontrol®	A.54
	Success story: AI-based anti-collision system for wind turbines	A.58
	Success story: Protection against major damage of offshore rotor blades	A.60



# Elevate your wind turbine performance

## Connectivity, Lighting & Monitoring Solutions



With many years of experience in the industry, Weidmüller is the expert for condition monitoring, digitalisation and connectivity for the wind industry. In addition to control cabinet components, we offer solutions for condition monitoring of rotor blades and bolted joints, as well as customised enclosure solutions.

### 1 BLADEcontrol® rotor blade monitoring



### 2 BOLTcontrol bolt breakage detection

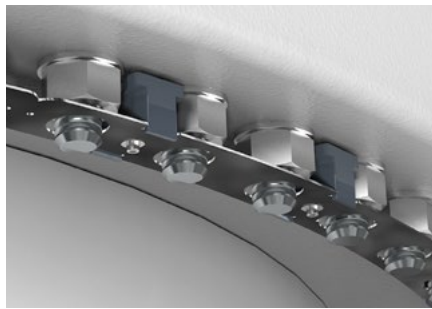

### 3 TwinCap® condition monitoring for blade bearings

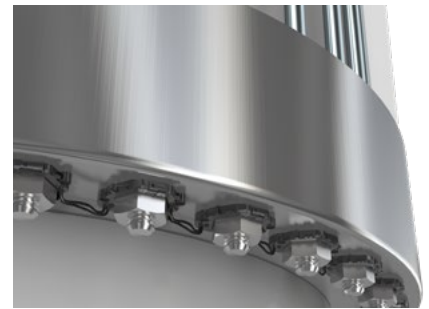

### 4 High-performance components for wind turbines



### 5 Customised solutions



For further information, technical specifications or additional services, please visit our website:  
[www.weidmueller.com/wind](http://www.weidmueller.com/wind)



# Customised solutions for the wind industry

## Operate wind turbines more efficiently with our tailored solutions for maximum profitability



Nowadays, the wind energy sector is faced with the challenge of meeting growing profitability requirements. Manufacturers of wind turbines are continuously seeking possibilities to reduce the LCOE (levelised cost of energy). Weidmüller meets this need with reliable components and customised solutions that reduce investment and operating costs. Condition monitoring and data-driven business models including Data Analytics have become essential for enhanced asset management. In these fields of automation and digitalisation, Weidmüller is able to provide tried-and-tested solutions to reduce downtimes and increase yield.



### 1 BLADEcontrol® rotor blade monitoring

- Lifetime extension of the rotor blades
- Increased turbine availability
- Additional yield through reduced downtimes
- Enhanced repair planning
- Optimised turbine efficiency



### 2 BOLTcontrol bolt breakage detection

- Maximum safety
- Protection against consequential damage to the wind turbine
- Reduction of downtimes and repair costs
- Adaptation to individual requirements of the turbine type



### 3 TwinCap® condition monitoring for blade bearings

- Detect critical bolt damages
- Continuous monitoring 24/7
- Additional yield through reduced downtimes
- Predictable repairs



### 4 High-performance components for wind turbines

- Circular connectors
- Automation technology
- Communication technology
- Electrical Package
- Switch and secure
- High-performance power supplies



### 5 Customised solutions

- Concept elaboration
- Prototyping
- Circuit diagram preparation
- Integration and testing
- Mechanical construction
- Serial production
- Software development
- After-sales support

## Get the most out of your system

### BLADEcontrol® – more transparency for maximum yield



BLADEcontrol® is the pioneer in rotor blade monitoring. The well-known condition monitoring system increases turbine availability, reduces downtimes and ensures optimum efficiency. With broad knowledge and many years of experience in the wind power industry, we bring transparency to your turbine to increase cost efficiency, revenue and turbine safety. In this way, you improve efficiency and reduce your risks in the long term.

The rotor blades of a wind turbine are exposed to particularly high stresses. Gusts of wind, storms, icing or lightning can cause minor damage that is not visible from the ground. This kind of damage is often only detected during routine maintenance, by which point the amount of repair work required will have considerably increased. In the worst-case scenario, the wind turbine may need to be shut down for weeks, meaning that no power will be generated.

The BLADEcontrol® monitoring system continuously records the condition of each rotor blade individually and detects even minor changes. 24 hours a day, 365 days a year. As a result, problems are identified much earlier than with visual inspections, and it prevents damage from progressing in an uncontrolled manner. This reduces the risk of expensive repairs and increases the economic efficiency of the entire turbine.

The sensitive BLADEcontrol® sensor system detects damage right from its initial stages. This allows you to take appropriate measures in good time, helping to avoid any system downtime. Only in the case of serious damage does BLADEcontrol® send a signal to the turbine control system, which can then stop the turbine immediately and prevent blade breakage.

In addition to damage to the rotor blades themselves, BLADEcontrol® also detects aerodynamic imbalances, loose parts in the blade and misalignments of the hub or pitch. This way, the system makes an additional contribution to the operational reliability of the turbine and helps to ensure a high energy yield.

New in 2024: BLADEcontrol® can now also be used for monitoring the main bearing. Early signs of damage can be detected up to a year before a repair becomes necessary. The only requirement for integrated main bearing monitoring is an installed BLADEcontrol® rotor blade monitoring system. No other hardware is required.

BLADEcontrol® is a monitoring system for rotor blades that has been continuously certified by Germanischer Lloyd (now: DNV) since 2008. It is the leading solution for rotor blade damage detection and in terms of monitoring experience.



After a lightning strike, for example, there is a high risk that damage may progress unnoticed. Thanks to continuous rotor blade monitoring with BLADEcontrol®, you are always on the safe side.



Calculate your individual return on investment  
[www.weidmueller.com/roi\\_calculator](https://www.weidmueller.com/roi_calculator)



## Be aware of when icing becomes critical

### BLADEcontrol® enables automatic restart



Cold and darkness make winter the peak season for supplying power. With decreasing yields from solar and water power, the demand for wind energy is greater than ever. With falling temperatures, however, many wind turbines shut down automatically as a result of the ice sensor on the nacelle signalling a risk of icing.

#### Accurate ice detection

BLADEcontrol® measures the level of icing directly on the rotor blades, which move through the frosty air at a rate of up to 250 km/h at the blade tips. The icing conditions at the blade tip are considerably different than those on top of the turbine nacelle, where some systems place ice sensors. Thanks to its direct measurement of ice formation where it actually occurs, namely on the blades, BLADEcontrol allows especially accurate detection. This helps you avoid the risk of icing going unnoticed or of wind turbines being taken out of service unnecessarily when significant ice formation has not actually occurred on the blades.

#### Automatic restart

BLADEcontrol® detects not only when rotor blades reach a critical icing level – but also when the danger has passed. As a result, the wind turbine can be restarted automatically at any time, day or night. There is no need for any on-site visual inspections. The automatic restart function is officially recognised and certified by DNV.

#### Effective measurement principle

BLADEcontrol® is based on a simple physical principle: due to its added weight, the ice build-up changes the natural vibration behaviour of the rotor blade, which in turn reduces the vibration frequency. Thanks to the highly sensitive sensor system and unique evaluation method, the system can achieve a measurement resolution in the millimetre range for detecting ice formation. Measurements can be taken both during operation and when the installation is at a standstill. This means that the turbine blades can be automatically checked before every startup to ensure that the blades are sufficiently free of ice.



# Effectively reduce repair and replacement costs

## Early damage detection thanks to BLADEcontrol®

Although visual rotor blade inspection reveals any damage apparent from the outside, the time at which the damage occurred may have long since passed. The defect may have significantly worsened since then. With BLADEcontrol®, damage can already be detected at its initial stage.

### Detection of even minor changes

BLADEcontrol® measures changes in the natural vibration behaviour of the rotor blade. This allows the system to detect damage inside the rotor blade that is not visible from the outside. This type of detection works reliably under all weather conditions.

### Accurate measurement and evaluation

Acceleration sensors in each rotor blade allow extremely accurate measurements – highly sensitive, multidimensional, and compactly housed in a single module. BLADEcontrol® combines the data from the rotor blades in the hub and transmits it to the nacelle. An evaluation unit installed in the tower base analyses and documents the data on a continual basis. Damage is detected, classified in relation to its severity, and then forwarded on.

### Fast response

BLADEcontrol® reports critical blade conditions directly to the turbine control system to enable a timely shutdown. All detected damage is simultaneously transmitted to the Weidmüller Monitoring Centre, where experts evaluate the data and prepare specific action recommendations for operators.

### Simple status control

BLADEcontrol® WebVis is our online portal which enables you to check the status of your turbine at any time. The dashboard provides a quick overview of your entire turbine portfolio. The contents are logically grouped and various filter functions, such as direct switching to other turbines and time range selection, ensure an effective workflow. Detailed information is available for each turbine. If you have questions about the status, the contact button takes you directly to our monitoring experts.

The Weidmüller Monitoring Centre experts determine whether there is any further damage to the blade or main bearing, or even if there are dynamic imbalances, and immediately communicate the results to the customer. This allows our customers to optimize the planning of necessary repairs and eliminates high follow-up costs.

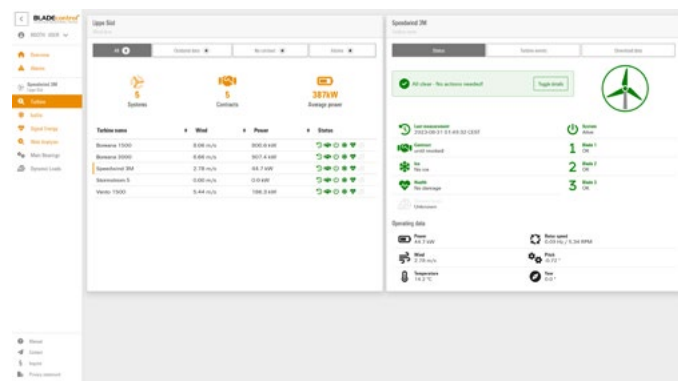

## Invest cleverly – increase added value

### Sustainable increase in yield with BLADEcontrol®



Cost efficiency and high profits are the most important factors when operating wind turbines. Continuous rotor blade monitoring with BLADEcontrol® has been proven to increase turbine availability and reduce maintenance and repair costs. The costs per installation are comparatively low, so the investment pays off quickly.

#### Quick amortisation

As the experience of our customers shows: BLADEcontrol® pays for itself after just a few years – and this applies to new and older turbines alike. The main reason for this is the increased yield thanks to the higher availability of turbines in winter months. As the turbine ages, however, the risk of rotor blade damage also increases. Early damage detection helps here to avoid unnecessarily high maintenance and repair costs, and therefore serves to optimise the efficiency of older turbines.

#### Easy retrofitting

BLADEcontrol® is already available for new turbines on request among many manufacturers. However, it is also easy to retrofit older systems. You tell us which functions you need, and we'll support you with the planning and carry out the installation and calibration for you, allowing you to increase the efficiency of your turbines just as you require.

BLADEcontrol® offers a certified solution for all application requirements:

- Reliable ice detection with automatic restart
- Damage detection with or without response of the machine control
- Damage monitoring and tracking with trend analysis by our Monitoring Centre

#### Secure yields with reduced cost risk

The total cost of a BLADEcontrol® system is only about ten percent of the cost of replacing a single 45-metre rotor blade. In other words, if just one blade replacement can be avoided over 20 years in a wind park with 10 turbines, then the purchase will have already paid off.



**BLADEcontrol®**  
CONDITION MONITORING SYSTEM

#### The unique advantages:

- Early damage detection
- Automatic restart
- Damage prevention
- Reduced repair costs
- Increased power generation
- Improved efficiency



Calculate your individual return on investment  
[www.weidmueller.com/roi\\_calculator](http://www.weidmueller.com/roi_calculator)

# Wind turbines compatible with BLADEcontrol®

BLADEcontrol® has already been installed in the following wind turbine types

Manufacturer	WPI type	Manufacturer	WPI type	Manufacturer	WPI type
<b>ACCIONA wind power</b>		<b>KENERSYS</b>		<b>Vestas</b>	
	Acciona AW1500		Kenersys K82		Vestas V90 1800KW
	Acciona AW116 3MW		Kenersys K100		Vestas V90 2MW Mk5
<b>ALSTOM ECOTÉCNIA</b>			Kenersys K110		Vestas V90 2MW Mk7
	ECO80	<b>LEITNER</b>			Vestas V90 3MW Mk8
<b>CSIC (Chongqing) Haizhuang Windpower Equipment</b>			Leitwind LTW80		Vestas V90 3MW Mk9
	H102-2.0MW		Leitwind LTW90-HH80		Vestas V90 2MW Mk3
	H93-2000L	<b>LEITWIND</b>			Vestas V90 2MW Mk8
<b>Dongfang Electric Corporation</b>			Leitwind LTW77-1500		Vestas V90
	DEC 1.5 MW	<b>Mingyang Smart Energy Group</b>			Vestas V90 2MW
	DEC 7.5-204		Mingyang MY1.5 SH-82		Vestas V100 Mk10B
<b>Doosan</b>			Mingyang MY2.0-104/85		Vestas V100-1.8 MW Mk7.4
	Doosan DS205-8MW		MySE3.0-135		Vestas V100-2.0 MW Mk10B
<b>ENERCON GmbH</b>		<b>Mitsubishi Heavy Industries Europe</b>			Vestas V100-1.8 MW Mk9
	Enercon E70/2000		Mitsubishi SeaAngel		Vestas V100-2.6 MW Mk9
	Enercon E82/2000	<b>Nordex Energy</b>			Vestas V100-2.0 MW Mk7H
	Enercon E-126 EP3		Nordex N60/1300 KW		Vestas V105/3450 Mk3A
<b>eno energy systems</b>			Nordex N80		Vestas V105/3600 Mk3A
	eno 100		Nordex N90		Vestas V110/2MW
	eno 114		Nordex N100		Vestas V112/3450 Mk3A
	eno 126		Nordex N117		Vestas V112/3600 Mk3A
	eno 140	<b>Senvion</b>			Vestas V112/3000
	eno 152		Senvion MM82		Vestas V112/3000 Mk1A
	eno 160 5.4 MW		Senvion MM92/2050		Vestas V112/3000 Mk1B
	eno 160 6.0 MW		Senvion MM100		Vestas V112/3300 Mk2A
<b>Envision Energy</b>			Senvion 3.XM 3.4M104		Vestas V112/3300 Mk2C
	Envision SC1 4MW		Senvion 3.XM 3.2M114		Vestas V112/3450 Mk2C
<b>Fuhrländer</b>			Senvion 3.XM 3.0M122		Vestas V112/3300 Mk3A
	Fuhrländer FL MD/77		Senvion 5M		Vestas V117/3300 Mk3B
	Fuhrländer FL 2500/90		Senvion 6.XM		Vestas V117/3300 Mk2A
	Fuhrländer FL 2500/100	<b>Shanghai Electric Windpower Group</b>			Vestas V117/3300 Mk2C
	Fuhrländer FL 2500/104		ShanghaiElectric 1.25MW		Vestas V117/3450 Mk2C
<b>FWT</b>			ShanghaiElectric W3600-90-116		Vestas V117/3450 Mk3A
	FWT 3000		ShanghaiElectric 6MW (SWT-6.0-172)		Vestas V117/3450 Mk3A
<b>GE</b>		<b>Siemens</b>			Vestas V117/3450 Mk3B
	GE 2.3		Siemens SWT-2.3-93		Vestas V117/4200 Mk3E
	GE 2.5-100		Siemens SWT-3.2-113		Vestas V117/3600 Mk3A
	GE 2.75-103		Siemens SWT-3.0-113		Vestas V126/3300 Mk3A
	GE 2.85-103		ADWEN M5000 - 116		Vestas V126/3300 Mk2A
	GE 3.2-103		Siemens SWT-4.2-130		Vestas V126/3300 Mk2C
	GE 4.2-117		Siemens SWT-3.6-130		Vestas V126/3450 Mk2C
	GE 2.5-120		ADWEN AD 5-135		Vestas V126/3450 Mk3A
	GE 2.75-120		Siemens SWT-3.15-142		Vestas V126/3450 Mk3B
	GE 2.X-127 (Legacy)		Siemens SG6.6-155		Vestas V126/3450 Mk2D
	GE 3.2-130		ADWEN AD 8-180		Vestas V126/3600 Mk3B
	GE 3.8-130		Siemens SWT-4.0-146		Vestas V126/3600 Mk3A
	GE 3.6-137	<b>Sinovel Wind Technology</b>			Vestas V136/3450 Mk3B
	GE 3.0-137		SL1500		Vestas V136/4000 Mk3E
	GE 3.4-137	<b>SkyWind</b>			Vestas V136/4200 Mk3E
	GE 3.8-137		SkyWind		Vestas V136/3450 Mk3A
	GE 4.8-158 Cypress	<b>VENSYS Energy</b>			Vestas V136/4200 Mk3F
	GE 5.3-158 Cypress		Vensys 1.5MW/77		Vestas V136/3000 Prototype
	GE 5.5-158 Cypress		Vensys 1.5MW/82		Vestas V136/3600 Mk3B
	GE 6.1-164 Cypress		Vensys 2.5MW/100		Vestas V136/3600 Mk3A
	GE Haliade-X 12		Vensys 2.5MW/112		Vestas V150/4000 Mk3E
<b>Goldwind Science &amp; Technology</b>			Vensys 4.1MW/115		Vestas V150/4200 Mk3E
	Goldwind GW82		Vensys 3MW/120		Vestas V150/5600 Mk0A EnVentus
	Goldwind GW87		Vensys 3.8MW/126		Vestas V150/6000 Mk0A EnVentus
<b>Guodian United Power Technology Company</b>			Vensys 3.5MW/136		Vestas V150/4300 Mk3E
	Guodian UP86	<b>Vestas</b>			Vestas V162/6000 Mk0A EnVentus
<b>Huolinhe</b>			Vestas V80-2MW		Vestas V162/5600 Mk0A EnVentus
	DF2.0-87		Vestas V80 2MW Mk8		Vestas V162/6200 Mk0A EnVentus
			Vestas V90 2MW Mk8C		

If a specific WPI is not included in the list, this does not mean that this WPI cannot be equipped with BLADEcontrol®. Please contact us in these cases.



# BOLTcontrol bolt breakage detection for wind turbines

## Monitor blade bearing bolts safely, permanently and easily



BOLTcontrol is a monitoring system that detects broken bolts in wind turbines. The system prevents consequential damage by holding the broken bolts securely in place. The patented monitoring system detects when a rotor blade bolt breaks and falls against the detection plate. By continuously monitoring the bolts, BOLTcontrol minimizes downtimes, reduces repair costs and ensures the safe continued operation of the turbine.

### Your advantages:

- Fulfills the requirements for blade bolt monitoring from the lifetime extension certificate, so that a bolt replacement or regular inspection is no longer necessary
- Easy integration into the wind turbine, mechanically, electrically and in terms of software
- Customised adaptation: the system can be adapted to different turbine types

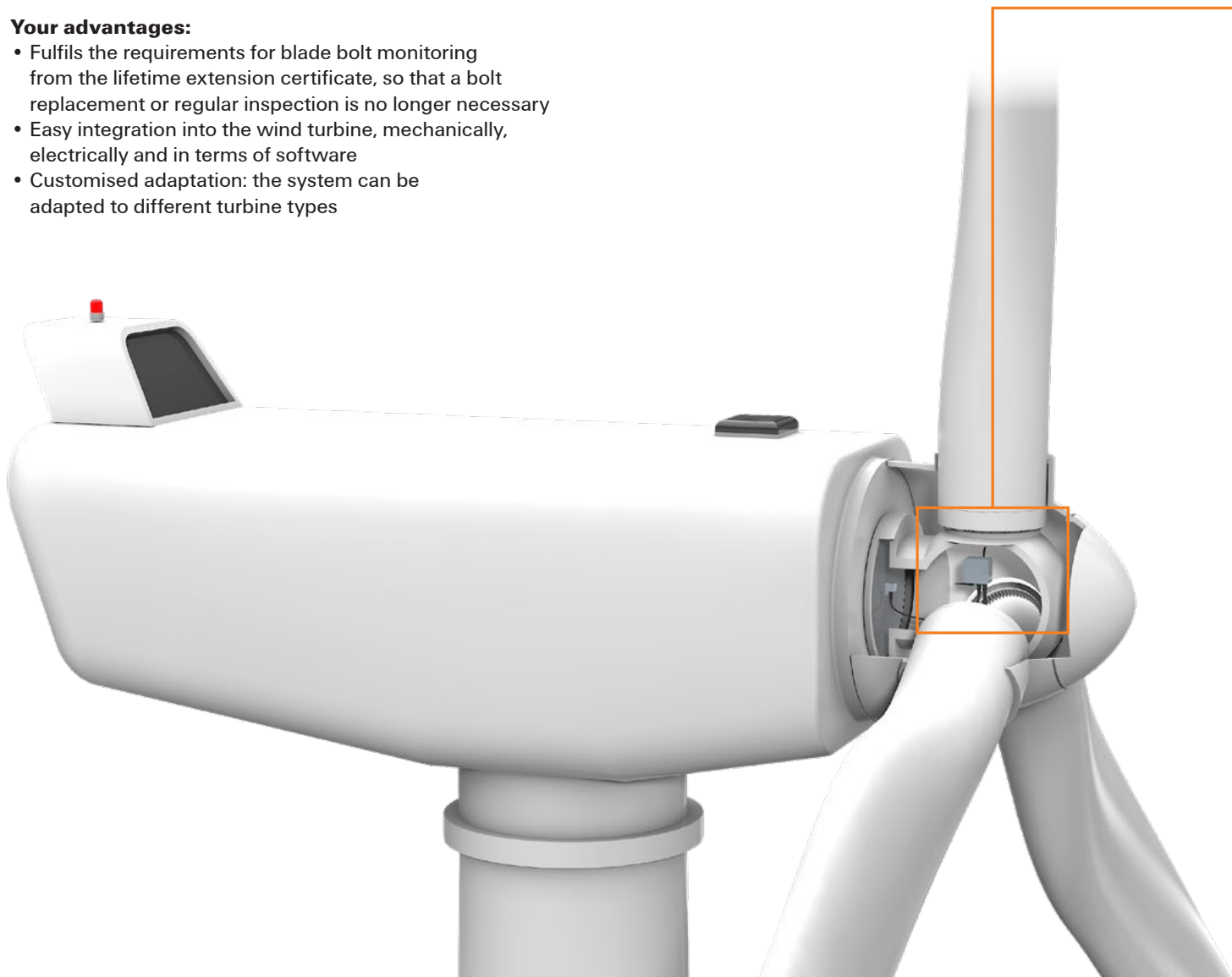



Detection plates for measuring and holding back broken bolts

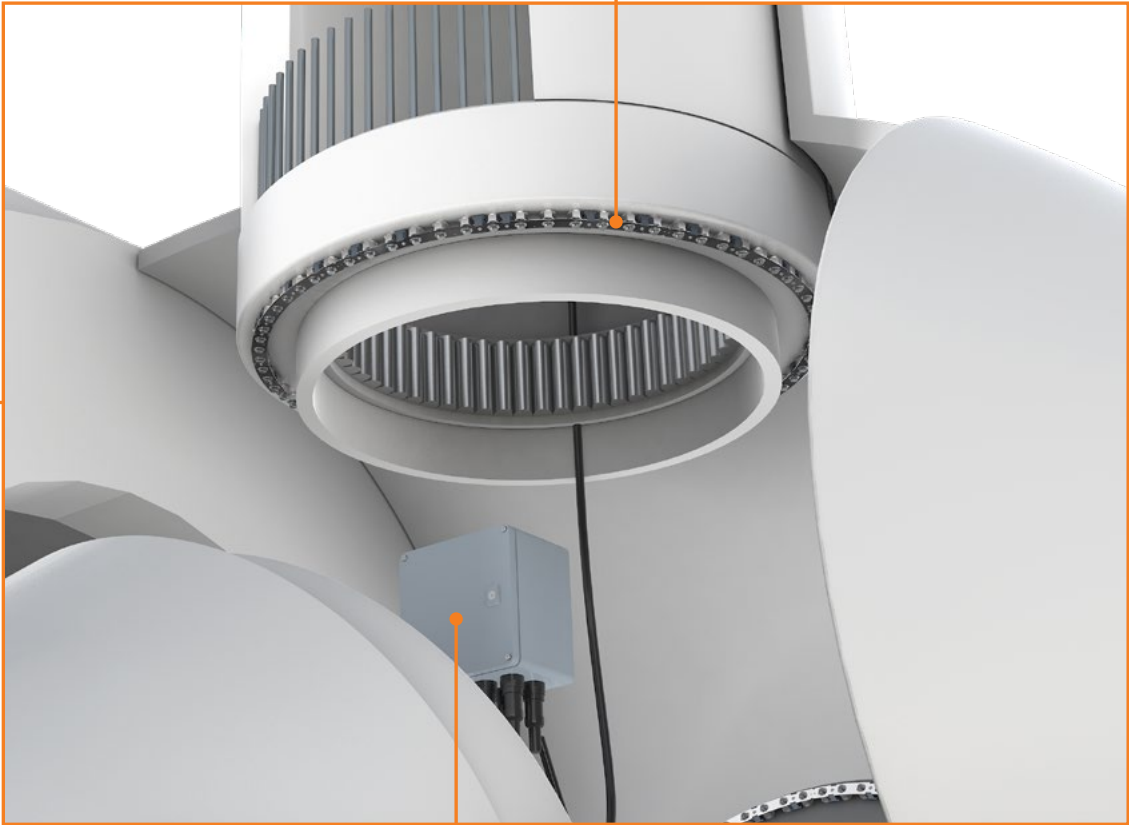

Evaluation unit with interface to the control system

Detection plates for measuring and holding back broken bolts on the rotor blade bearing



Variants for different wind turbine types



Evaluation unit as a stand-alone device



Evaluation unit for cabinet integration



## Early detection of damaged nuts

### TwinCap® – Sensors for reliable condition monitoring



During the lifetime of a wind turbine, the bolts are exposed to dynamic forces that can lead to cracks, damages and fractures. For a safe and reliable operation of the wind turbine, every single bolt must be functional and undamaged.

The condition monitoring system for blade bearings was developed to detect bursting of the nuts. In affected wind turbines, a broken bolt nut is an indicator of a crack in the outer ring of the blade bearing. Without condition monitoring, cracks continue to propagate unnoticed, which can ultimately lead to a blade loss. The TwinCap® system can be retrofitted to any type of turbine on highrisk turbines to reduce maintenance costs, avoid downtime and prevent a blade loss.

The TwinCap® system consists of a specific number of sensors and a corresponding evaluation unit, which is integrated into the pitch system of the wind turbine. The evaluation unit ensures the safe shutdown of the wind turbine in the event of a blade bearing crack. By making minor customizations to the interfaces and the control of the evaluation unit, it is possible to create a customer-specific solution for other turbine types or applications.

#### Specifications:

- Detects a crack in bolt nuts of 2 mm at the outer edge of a M30 bolt nut
- Protection class IP68 / offshore robust
- Integrated LED to indicate a nut break
- Gold plated contacts
- Shock and vibration resistance
- Expected lifetime >30 years
- Temperature range -40...70 °C
- Mounting via magnetic feet





**Sensors**

- To detect nut breakages
- Daisy chain, minimized wiring
- Fixed with magnets
- Easy mounting and dismounting

**Evaluation unit**

- Located in the hub of the turbine
- Integrated into the pitch system
- Automatic shutdown
- Multi input voltage range



**Drag chain cable**  
connection between sensor string  
and evaluation unit

**Ordering data**

Type	Description	Order No.
FRS TWC M30 SC 10	Sensor Set with 10 Start Caps	2881690000
FRS TWC M30 MC 25	Sensor Set with 25 Middle Caps	2861190000
FRS TWC M30 EC 10	Sensor Set 10 End Caps	2881700000
SAIBP-M-5A-4/8-M12	Field attachable connector, M12, Female socket, straight	2681620000
SAISP-M-5A-4/8-M12	Field attachable connector, M12, Male socket, straight	2681600000
SAIL-M12BG-4S10T	10m drag chain cable, M12, Female / open cable end	1283321000



TwinCap®

FRS TWC M30 SC 10

FRS TWC M30 MC 25



Technical data

Sensor specification		
Housing main material	PA66/6	PA66/6
Contact surface	gold plated	gold plated
Protection degree	IP68	IP68
Resistance against	grease, oil, lubricants	grease, oil, lubricants
Shock resistance	150 m/s <sup>2</sup> @ 11 ms	150 m/s <sup>2</sup> @ 11 ms
Vibration resistance	1.5 mm @ 9...200 Hz	1.5 mm @ 9...200 Hz
UL94 flammability rating	V-0	V-0
Type of connector	M12 male plug, 4 pin	Magnet
Type of mounting	Magnet	10 years
Expected lifetime	10 years	24 V DC
Electrical data		
Sensor supply voltage	24 V DC	24 V DC
Environmental ratings		
Operating temperature	-40...+70 °C	-40...+70 °C
Storage temperature	-40...+70 °C	-40...+70 °C
Temperature changes	up to 1 °C / min	up to 1 °C / min
Humidity	0...98 %	0...98 %
Approvals		
Standards	UL	UL
Certifications	TÜV	TÜV

Ordering data

Type	Qty.	Order No.	Type	Qty.	Order No.
FRS TWC M30 SC 10	10	2881690000	FRS TWC M30 MC 25	25	2861190000
Further information on request			Further information on request		

Note

## FRS TWC M30 EC 10



PA66/6

gold plated

IP68

grease, oil, lubricants

150 m/s<sup>2</sup> @ 11 ms

1.5 mm @ 9...200 Hz

V-0

Magnet

10 years

24 V DC

-40...+70 °C

-40...+70 °C

up to 1 °C / min

0...98%

UL

TÜV

Type	Qty.	Order No.
FRS TWC M30 EC 10	10	2881700000
Further information on request		



## IP 68 circular connectors

### Screwable and clickable circular connectors

A



Our robust IP 68 round connectors enable quick and easy connection of cables and your application of choice.

- IP 68 protection class
- Screwable and clickable connection possible
- 2, 3, 4 or 5 poles
- Cable connectors, panel connectors, h-distributor, protective caps and mounting tool available
- Smart and compact design to reduce installation times
- Integrated coding





**Screwable circular connectors**



- Plug and socket for housing installation
- 2 or 4 poles
- IP 66/ IP 68
- Fast, screwable connection
- Integrated coding



- Plugs and sockets for connection to cables
- 2 or 4 poles
- IP 66/ IP 68
- Fast, screwable connection
- Integrated coding



- H-distributors
- 4 poles
- IP 68
- Fast, screwable connection
- Integrated coding



- Sealing cap for plugs and sockets
- Protection against dust and water during transport, connection and operation



- Mounting tool for the circular connectors above

**Clickable circular connectors**



- Plug and socket for housing installation
- 3 or 5 poles
- IP 66/ IP 68
- Fast, screwable connection
- Integrated coding



- Plugs and sockets for connection to cables
- 3 or 5 poles
- IP 66/ IP 68
- Fast, screwable connection
- Integrated coding

Round connectors IP68 - connection technology for every use

RC F/M P2 SP

RC F/M P2 M20 SP



Technical data

Cable diameter, min./max.	7...13 mm
Coding	none
Conductor cross-section, min./max.	0.5...4 mm <sup>2</sup>
Contact material	Brass
Contact surface	Brass
Min. dismantling length	25 mm
Protection degree	IP68
Rated current	17.5 A
Rated impulse withstand voltage	4 kV
Rated voltage	500 V
Shield connection	No
Stripping length	6
<b>General data</b>	
Housing main material	PA 66
Number of poles	2
Reverse polarity protection	Yes
Type	
Type of connection	Screw connection
<b>Approvals</b>	
Approvals	CE, CULUS
UL 94 flammability rating	V-2
<b>Note</b>	

Cable diameter, min./max.	7...13 mm
Coding	none
Conductor cross-section, min./max.	0.5...4 mm <sup>2</sup>
Contact material	Brass
Contact surface	Brass
Min. dismantling length	25 mm
Protection degree	IP68
Rated current	17.5 A
Rated impulse withstand voltage	4 kV
Rated voltage	500 V
Shield connection	No
Stripping length	6
<b>General data</b>	
Housing main material	PA 66
Number of poles	2
Reverse polarity protection	Yes
Type	
Type of connection	Screw connection
<b>Approvals</b>	
Approvals	CE, CULUS
UL 94 flammability rating	V-2
<b>Note</b>	

Cable diameter, min./max.	7...13 mm
Coding	none
Conductor cross-section, min./max.	0.5...4 mm <sup>2</sup>
Contact material	Brass
Contact surface	Brass
Min. dismantling length	25 mm
Protection degree	IP68
Rated current	17.5 A
Rated impulse withstand voltage	4 kV
Rated voltage	500 V
Shield connection	No
Stripping length	6
<b>General data</b>	
Housing main material	PA 66
Number of poles	2
Reverse polarity protection	Yes
Type	
Type of connection	Screw connection
<b>Approvals</b>	
Approvals	CE, CULUS
UL 94 flammability rating	V-2
<b>Note</b>	

Ordering data

Type	Qty.	Order No.
Female	1	2903200000
Pin	1	2903190000
<b>Note</b>		

Type	Qty.	Order No.
RC F P2 SP	1	2903200000
RC M P2 SP	1	2903190000
<b>Note</b>		

Type	Qty.	Order No.
RC F P2 M20 SP	1	2860640000
RC M P2 M20 SP	1	2860650000
<b>Note</b>		

RC F/M P3 C



7...13 mm
none
0.25...1.5 mm <sup>2</sup>
Brass
Brass
25 mm
IP68
17.5 A
2.5 kV
500 V
No
6
PA 66
3
Yes
PUSH IN, Lever clamp, PUSH IN with actuator
CE
V-2, V-0

Type	Qty.	Order No.
RC F P3 C SP	1	2992970000
RC M P3 C SP	1	2992960000

RC F/M P3 M20 C



7...13 mm
none
0.25...1.5 mm <sup>2</sup>
Brass
Brass
25 mm
IP68
17.5 A
2.5 kV
500 V
No
6
PA 66
3
Yes
PUSH IN, Lever clamp, PUSH IN with actuator
CE
V-2, V-0

Type	Qty.	Order No.
RC F P3 M20 C SP	1	2992990000
RC M P3 M20 C SP	1	2992980000

**Round connectors IP68 - connection technology for every use**

**RC F/M P4**

**RC F/M P4 M20**



**Technical data**

<b>Technical data</b>	
Cable diameter, min./max.	7...13 mm
Coding	none
Conductor cross-section, min./max.	0.5...4 mm <sup>2</sup>
Contact material	Brass
Contact surface	Brass
Min. dismantling length	25 mm
Protection degree	IP68
Rated current	17.5 A
Rated impulse withstand voltage	4 kV
Rated voltage	500 V
Shield connection	No
Stripping length	6
<b>General data</b>	
Housing main material	PA 66
Number of poles	4
Reverse polarity protection	Yes
Type	
Type of connection	Screw connection
<b>Approvals</b>	
Approvals	CE
UL 94 flammability rating	V-0
<b>Note</b>	

<b>Technical data</b>		
Cable diameter, min./max.	7...13 mm	
Coding	none	
Conductor cross-section, min./max.	0.5...4 mm <sup>2</sup>	
Contact material	Brass	
Contact surface	Brass	
Min. dismantling length	25 mm	
Protection degree	IP68	
Rated current	17.5 A	
Rated impulse withstand voltage	4 kV	
Rated voltage	500 V	
Shield connection	No	
Stripping length	6	
<b>General data</b>		
Housing main material	PA 66	
Number of poles	4	
Reverse polarity protection	Yes	
Type		
Type of connection	Screw connection	
<b>Approvals</b>		
Approvals	CE	
UL 94 flammability rating	V-0	
<b>Note</b>		

<b>Technical data</b>		
Cable diameter, min./max.	7...13 mm	
Coding	none	
Conductor cross-section, min./max.	0.5...4 mm <sup>2</sup>	
Contact material	Brass	
Contact surface	Brass	
Min. dismantling length	25 mm	
Protection degree	IP68	
Rated current	17.5 A	
Rated impulse withstand voltage	4 kV	
Rated voltage	500 V	
Shield connection	No	
Stripping length	6	
<b>General data</b>		
Housing main material	PA 66	
Number of poles	4	
Reverse polarity protection	Yes	
Type		
Type of connection	Screw connection	
<b>Approvals</b>		
Approvals	CE	
UL 94 flammability rating	V-0	
<b>Note</b>		

**Ordering data**

<b>Ordering data</b>	
Female	
Pin	
<b>Note</b>	

Type	Qty.	Order No.
RC F P4		3136940000
RC M P4		3136930000
<b>Note</b>		

Type	Qty.	Order No.
RC F P4 M20		3136920000
RC M P4 M20		3136910000
<b>Note</b>		

RC F/M P5 C



7...13 mm
none
0.25...1.5 mm <sup>2</sup>
Brass
Brass
25 mm
IP68
17.5 A
2.5 kV
500 V
No
6
PA 66
5
Yes
PUSH IN with actuator
CE
V-0

Type	Qty.	Order No.
RC F P5 C	1	2934520000
RC M P5 C	1	2934530000

RC F/M P5 M20 C



7...13 mm
none
0.25...1.5 mm <sup>2</sup>
Brass
Brass
25 mm
IP68
17.5 A
2.5 kV
500 V
No
6
PA 66
5
Yes
PUSH IN with actuator
CE
V-0

Type	Qty.	Order No.
RC F P5 M20 C	1	3036850000
RC M P5 M20 C	1	3036860000

H-distributor

RC D 4/4P



Technical data

Cable diameter, min./max.	7...13 mm
Coding	none
Conductor cross-section, min./max.	0.5...4 mm <sup>2</sup>
Contact material	Brass
Contact surface	Brass
Min. dismantling length	
Protection degree	IP68
Rated current	17.5 A
Rated impulse withstand voltage	4 kV
Rated voltage	450 V
Shield connection	No
Stripping length	
<b>General data</b>	
Housing main material	PA 66
Number of poles	4
Reverse polarity protection	Yes
Type	
Type of connection	Screw connection
<b>Approvals</b>	
Approvals	CE, CULUS
UL 94 flammability rating	V-2
<b>Note</b>	

Ordering data

Type	Qty.	Order No.
RC D 4/4P	60	2819550000
<b>Note</b>		

Protective caps

PC RC F/M



Technical data

General data	
Connection thread	
Insulating material	
Material	
Protection degree	IP67
Type	
Approvals	
Approvals	CULUS
UL 94 flammability rating	V-2
Note	

Ordering data

Type	Qty.	Order No.
Female	200	2820090000
Pin	200	2833850000
Note		

# Maximising system availability

## Reliable and future-proof protection



The continuous increase in limit values within the standards, put great emphasis on the need for all-round, reliable surge protection. In response to these growing requirements the VPU, VSPC and VSSC lightning and surge protection series offer standard exceeding protection for all kinds of applications. Based on a combined varistor gas discharge technology the VPU series is a future orientated series of products that protect your energy grid and power supply at the highest level. However, you will not just be protecting your plant, but also your planning processes. Conformity with standards for at least five years means that you can minimise your planning iteration steps and the redesigns associated with them.

Many intelligent product features help installers during installation and maintenance specialists during their servicing of the lightning and surge protection system. Equipped in this way, the VPU series provides a long-lasting, safe and future-proof lightning and surge protection solution for your system.

Our pluggable VSPC surge protection is characterised by the highest protective functions with compact dimensions. The arrestors of the modules can be removed, measured or exchanged during running operation impedance-neutral – without interrupting the measuring circuit. These features make this product the ideal secure protection mechanism for interfaces within instrumentation and control circuits.





# VARITECTOR Lightning and Surge Protection Solutions for wind energy generation

## Protection for energy systems VPU I, VPU II and VPU III



Surge protection products effectively reduce the interference coupling that can occur from transient surge voltages, even significantly below the limits prescribed by insulation coordination according to EN 60664-3/DIN VDE 0110-3.

## Protection for energy systems VPU II ASI



All products of the VPU AC series have optical signaling. Variants with a pre-warning display enable uninterrupted protection. The remote signaling output indicates the pre-warning status.

## Protection for instrumentation and control (I&C) VSPC & VSSC



Overvoltage coupling along the conductor path may disturb or destroy sensitive signal inputs. It is important to provide protection in the immediate vicinity of I&C devices. Weidmüller's broad product range for the I&C sector offers products in a two-piece, pluggable design and modular terminals for tension clamp or screw connection.

## Protection for data interfaces VDATA, VSPC & VSSC



"Data transmission" is the transfer of characters, numbers, statuses and measurements, between different, decentralised units. "Decentralised units" are controls, computers, measurement sensors and actuators. Appropriate overvoltage protection is essential for such sensitive areas.



Visit our website for more information  
[www.weidmueller.com/lightning-and-surge-protection](http://www.weidmueller.com/lightning-and-surge-protection)

### Advantage Status Indication (ASI)

The VPU AC II Y series is equipped with ASI – Advanced Status Indication technology. The yellow status signal indicates that the product is approaching its performance limit due to frequent overvoltages. Your system is still protected because the arrester units are redundant with two varistors. If a varistor fails, full protection is still available. This status window and at the remote signaling contact. Only when showing the red status the arrester is completely disconnected from the power grid.



## Application area

### Surge protection

A

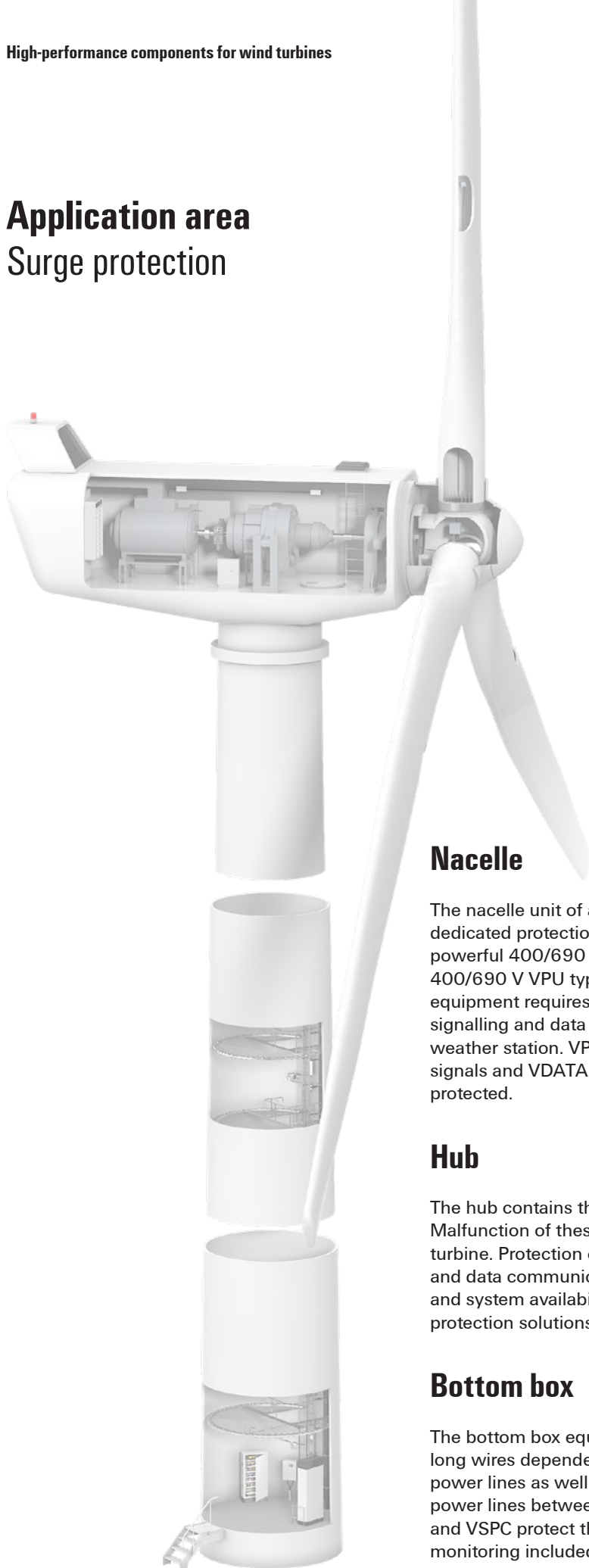

### Nacelle

The nacelle unit of a wind turbine contains multiple systems that require dedicated protection concepts. Generator lines need to be protected with powerful 400/690 V protection units e.g. with a three-pole 400/690 V VPU type I and II classified protection unit. Sensor box equipment requires power line protection for 230 V supply as well as signalling and data line protection e.g. for the incoming signals from the weather station. VPU 300 V power components, VSPC for measurement signals and VDATA for ethernet lines ensures that the equipment is safely protected.

### Hub

The hub contains the sensitive electronics of the pitch control systems. Malfunction of these systems could cause a total breakdown of the turbine. Protection concepts for the power supply, monitoring systems and data communication systems have to ensure a complete protection and system availability. VPU 300 V, VSPC and VDATA deliver total protection solutions for these kind of elements.

### Bottom box

The bottom box equipment is connected to the top box equipment via long wires dependent upon the turbine type. This requires protection of power lines as well as signal lines at both ends. The same is true for the power lines between generator and inverter. VPU 400/690 V products and VSPC protect the lines reliably and if needed, with real time status monitoring included.



Hub and nacelle



Type	Order No.
VPU AC II 1+1 R 300/50	2591070000
VSPC 4SL 24VAC R	8951600000
VSPC BASE 4SL FG R	8951760000
VDATA CAT 6	1348590000

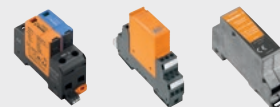

Type	Order No.
VPU AC II 1+1 R 300/50 Y	2639340000



Type	Order No.
VSPC 4SL 24VAC R	8951600000
VSPC BASE 4SL FG R	8951760000
VSPC 2SL 24VAC R	8951640000
VSPC BASE 2SL FG R	8951780000

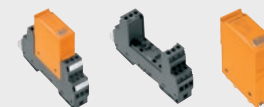

Nacelle and tower



Type	Order No.
VPU AC II 3 R 350/50	2591110000



Type	Order No.
VSPC 4SL 24VAC R	8951600000
VSPC BASE 4SL FG R	8951760000



Type	Order No.
VPU II 1 1000V/40kA AC	1473440000
VPU II 1 R 1000V/40kA AC	2811930000



Tower base



Type	Order No.
VPU AC II 3 R 300/50 Y	2639330000



Type	Order No.
VPU AC I 3+1 R 440/25 LCF	2619260000



Type	Order No.
VPU AC I 3+1 R 440/25 LCF	2619260000
VPU AC II 3 R 750/35	2591320000



## Availability at the highest stage

### Reliable and future-proof switching



Whether switching, separating, amplifying or multiplying: Relays perform a multitude of different tasks in industrial applications - including in the wind industry. Optimizing the control cabinet infrastructure plays a decisive role in this. In response to these growing demands, Weidmüller offers a relay portfolio with decades of technical expertise combined with comprehensive understanding of the wind market.

Klippon® Relay offers high-quality relay modules and solid-state relays that meet wind turbines requirements. Thanks to PUSH IN technology, our relays can be installed easily, quickly and conveniently, resulting in a significant reduction in wiring time. In addition, the TERMSERIES and TERMSERIES-compact product range offers multi-voltage inputs with an input voltage range of 24 - 230 V UC, which reduces the width of your stock.

Our relay range offer special designed relays with a special contact design to reliably switch LED lights. This for sure includes our 48 V DC tower lighting solutions from Weidmueller.

At the same time, the high vibration requirements for wind turbines are also met. Thus equipped, the Klippon® Relay series offers a durable, safe and quality-proof solution for the control cabinets of your wind turbine.





# Best application fit

## Tailored solutions based on standard products

### Modular 6 mm relay modules **TERMSERIES**

- Pluggable relays and solid-state relays
- Easy replacement in a modular system
- Large illuminated ejection lever as status LED
- Integrated marker holder

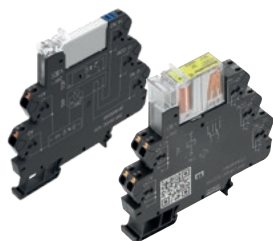

### **TERMSERIES-compact TRAK**

- Tested in accordance with DIN EN 50155 and EN 61373 and EN 45545-2
- Resistant to voltage and temperature fluctuations
- Not sensitive to shocks and vibration
- Highly compact with a width of just 6.4 mm and a depth of 63 mm



### High-quality universal relays **D-SERIES**

- Relays for the separation of input and output signals in industrial automation
- Pre-assembled KITS consisting of relay socket and retaining clip
- Tailor-made accessories from cross-connections to marker



**All Weidmüller KITS (complete modules) are function- and insulation-tested**

### Selection guide for electro-mechanical relay modules



Our **digital selection** guide will assist you to find the right relay for safe and reliable switching of special loads.  
[www.weidmueller.com/relayselector](http://www.weidmueller.com/relayselector)



## Application area

### Relays

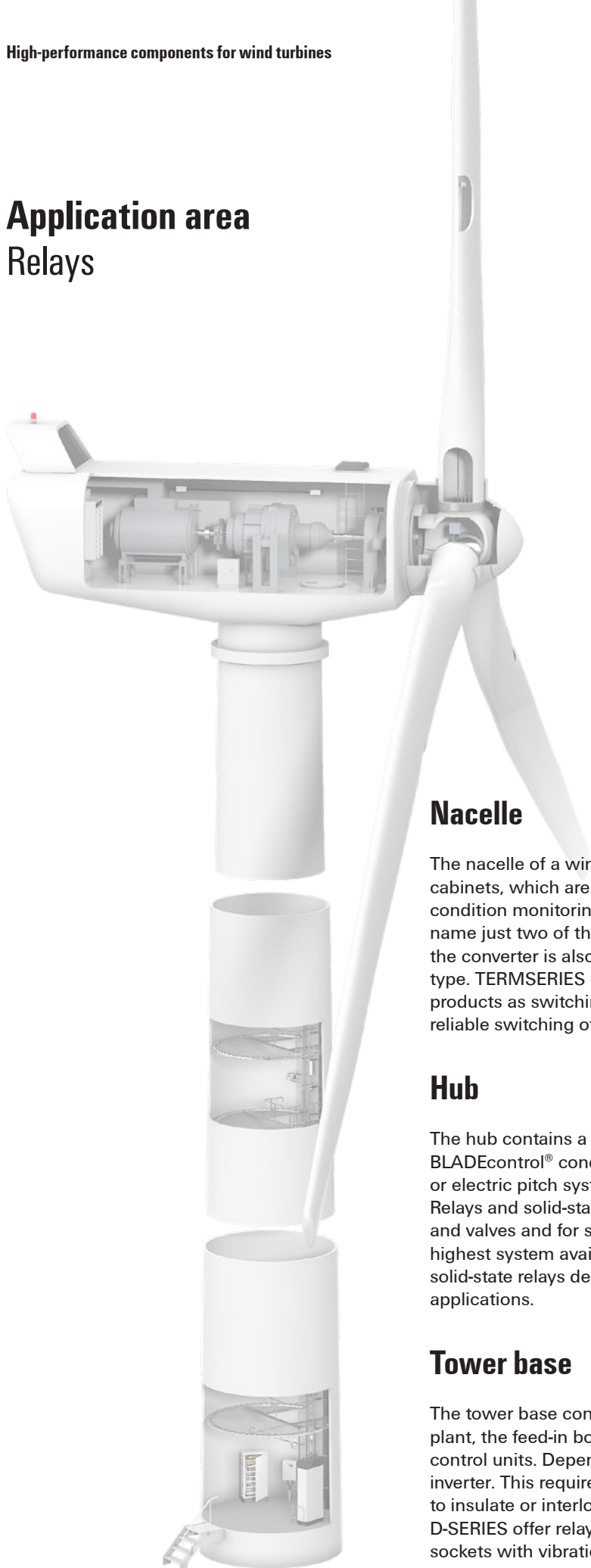

### Nacelle

The nacelle of a wind turbine contains several systems and control cabinets, which are equipped with relays. These are switching unit for condition monitoring systems or the top box for general functions, to name just two of the many systems inside the nacelle. In some turbines, the converter is also located in the nacelle, this depends on the tower type. TERMSERIES relays and solid-state relays deliver space saving products as switching amplifier or for signal interlocking. Furthermore, for reliable switching of LED lights.

### Hub

The hub contains a rotor blade heater that can be controlled by our BLADEcontrol® condition monitoring system. Furthermore, the hydraulic or electric pitch system for rotor blade adjustment is located in the hub. Relays and solid-state relays as reliable switching amplifier for contactors and valves and for signal insulation between different boxes ensure highest system availability on smallest place. TERMSERIES relays and solid-state relays deliver a wide range of products for these kind of applications.

### Tower base

The tower base contains the switching unit for the ventilation of the plant, the feed-in box for the interior lighting of the tower and various control units. Depending on tower type, the tower base also contains the inverter. This requires relays for signal insulation and contact multiplying to insulate or interlock between the different systems. RIDERSERIES and D-SERIES offer relays with multiple channels and wiring optimized sockets with vibration resistant and fast PUSH IN connections.



Hub and nacelle



Type	Order No.
TRP 24VDC 1CO	2618000000
TRP 24VDC 1CO AU	2618110000
TRP 24-230VUC 1CO ED2	2663010000
MCZ R 48...110Vdc 1CO TRAK	8713910000
MCZ R 48...110VDC 1CO AU TRAK	8790500000

Type	Order No.
TOP 24VDC 230VAC1A	2618420000
TOP 24VDC 24VDC2A	2618720000
TOP 24-230VUC 24VDC2A ED2	2663080000

Type	Order No.
TRP 24VDC 1CO	2618000000



Nacelle and tower



Type	Order No.
TRP 24VUC 2CO FG	2706430000
RCIKITZ 24VDC 2CO LD/FG	1218390000

Type	Order No.
TRP 24VDC 1CO	2618000000
TRP 24VDC 1CO 16A	2618100000
TRP 24VDC 1NO HC	2618090000
TRP 24-230VUC 1NO HC ED2	2663130000
TRP 24-230VUC 2CO ED2	2663040000
TRP 24VDC 2CO	2618400000

Type	Order No.
TRP 24VDC 1NO HCP	2617930000
TRP 24-230VUC 1NO HCP ED2	2663140000



Tower base



Type	Order No.
DRIKITP 24VDC 2CO LD/PB	2576190000
DRMKITP 24VDC 4CO LD/PB	2576140000

Type	Order No.
TRP 24VUC 2CO FG	2706430000
RCIKITZ 24VDC 2CO LD/FG	1218390000

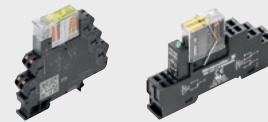

## Switch-mode power supply units

Large product assortment – Tailored solutions for optimal fit.



The PROtop series is made for harsh environments, long lifetimes & high reliability. For instance is the PROtop providing guaranteed operating data at -40°C continuous operating and a very high vibration resistance. The new DCL technology for reliably tripping of circuit breaker is just as mandatory as the integrated ORing MOSFET for direct parallel connection or the optional plug-on communication modules for data monitoring or remote control.

Our PROmax series is a very good choice for moderate environmental conditions and provides a start-up temperature of -40°C. Even this series has a perfectly balanced and robust design for the use in wind mills and can withstand ambient temperature of up to 70°C.

The combination of load monitoring elements and potential distribution terminals saves up to 50 % space and up to 20% time with wiring work, while the flexible compatibility of numerous single-channel and four-channel variations optimises material costs. maxGUARD offers you the benefits of a modular, highly flexible system that can be optimally adapted to any application.





# High-performance power supplies

## Maximum power for all environments

### Innovative power supply units **PROtop**



- Optimum efficiency levels (up to 95.3 %) for sustainable energy savings
- High dynamic range thanks to unique DCL technology
- Communication modules for condition monitoring
- Direct parallel connection through integrated ORing MOSFETs
- Wide range of approvals

### Powerful supply unit **PROmax**



- Reliably copes with continuous overload of up to 20% or short-term peak loads of 300%
- Safe operation with high power reserves up to 60 °C and start-up at -40 °C
- Capable of handling continuous overload or transient peak loads with ease
- Suitable for confined spaces thanks to their low width

### Intelligent electronic load monitoring **maxGUARD**



- Modular, highly flexible system that can be optimally adapted to any application
- Potential distributors with a 6.1 mm pitch ensure space-savings of up to 50 % on the rail
- Time savings of up to 20 % due to unique cross-connectors between load monitoring and potential distribution terminals
- Extreme ease of service during commissioning and maintenance
- Practical disconnecting lever for simple galvanic isolation of the load circuit

### High performance and compact design **PRObas**



- Compact design with flexible mounting (DIN rail or wall)
- High efficiency up to 95%
- -25 bis +70°C wide operating temperature range (Start-Up at -40°C)
- International approvals (cULus, NEC Class2 and cCSAus)

## Application area

### Power supplies

A

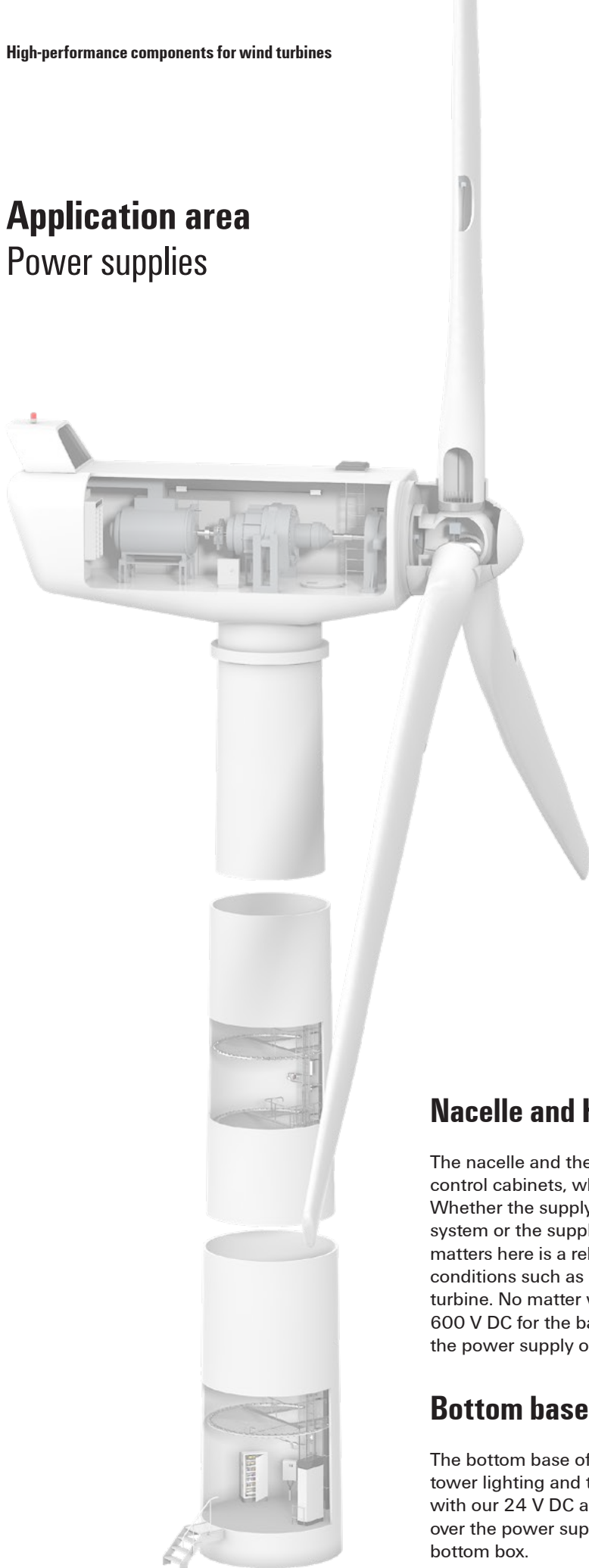

### Nacelle and Hub

The nacelle and the hub of a wind turbine contains several systems and control cabinets, where our power supply solutions can find place. Whether the supply of the valve control from the electro-hydraulic pitch system or the supply voltage for the control of the wind turbine. What matters here is a reliable voltage supply that can meet the harsh conditions such as large temperature changes and vibrations in a wind turbine. No matter whether you need 24 V DC for the control system or 600 V DC for the back-up system of the pitch control, our solutions for the power supply offer the right components for every case.

### Bottom base

The bottom base of the wind turbine contains the power supply for the tower lighting and the bottom box. Light up your wind turbine reliably with our 24 V DC and 48 V DC power supplies. Our PROtop Com takes over the power supply and also enables communication between top and bottom box.



Nacelle and Hub



Type PROtop	Order No.
<b>1-phase</b>	
PRO TOP1 120W 24V 5A	2466870000
PRO TOP1 240W 24V 10A	2466880000
PRO TOP1 480W 24V 20A	2466890000
<b>3-phase</b>	
PRO TOP3 120W 24V 5A	2467060000
PRO TOP3 240W 24V 10A	2467080000
PRO TOP3 480W 24V 20A	2467100000



All variants are also available with protective circuit board for continuous low temperatures of -40 °C. Special mounting brackets allow vibration resistance up to 4 g.

Type PROmax	Order No.
<b>1-phase</b>	
PRO MAX 120W 24V 5A	1478110000
PRO MAX 240W 24V 10A	1478130000
PRO MAX 480W 24V 20A	1478140000
<b>3-phase</b>	
PRO MAX3 120W 24V 5A	1478170000
PRO MAX3 240W 24V 10A	1478180000
PRO MAX3 480W 24V 20A	1478190000



Type PRObas	Order No.
PRO BAS 30W 24V 1.3A	2838500000
PRO BAS 30W 12V 2.6A	2838510000
PRO BAS 30W 5V 6A	2838400000
PRO BAS 60W 24V 2.5A	2838410000
PRO BAS 60W 12V 5A	2838420000
PRO BAS 90W 24V 3.8A	2838430000
PRO BAS 120W 24V 5A	2838440000
PRO BAS 120W 12V 10A	2838450000
PRO BAS 240W 24V 10A	2838460000
PRO BAS 240W 48V 5A	2838470000
PRO BAS 480W 24V 20A	2838480000
PRO BAS 480W 48V 10A	2838490000



Type maxGUARD	Order No.
AMG FIM-0	2081870000
AMG FIM-C	2081880000
AMG EP KIT	2500760000
AMG ELM-6	2080360000
AMG ELM-12	2080410000
AMG ELM-1F	2080420000
AMG ELM-2F	2080480000
AMG ELM-4F	2080490000
AMG ELM-6F	2080500000
AMG ELM-8F	2080600000
AMG ELM-10F	2080650000
AMG OD	2122910000
AMG PD	2122920000
AMG MD	2122930000
AMG XMD	2122940000
AMG PP	2123000000



Here is an extract from the comprehensive maxGUARD portfolio

Bottom base



Type PRO COM	Order No.
PRO COM CAN OPEN	2467320000
PRO COM IO-LINK	2587360000



## Protected connections

### The right connection for your wind turbines



Whether circular connectors for signal processing between sensor and controller or heavy duty connectors with IP67 for power transmission, Weidmüller offers appropriate connection solutions for the supply of power, signals, and data between nacelle and the bottom box of your wind turbines. Our offer does not end with the production of the connector, but is complemented by our demand-oriented assembly services. In this way, we help to easily master even complex cabling tasks and are the best partner for implementing complete connection solutions, from individual connectors to cabling concepts to smart solutions for your turbines.



## Product range

Well conceived connections increase your Efficiency

### Heavy duty connectors **RockStar®**



- Nine insert families in up to twelve sizes
- Safe transmission of currents up to 35 amps and voltages up to 830 volts
- Reliable signal transmission at packing densities up to 216 poles
- Screw, tension spring, crimp, axial, PUSH IN, and SNAP IN connection

### Round connectors **SAI**



- All relevant circular connectors for industrial applications
  - M8/M12 connectors
  - M12 power connectors
  - M23 connectors
  - 7/8" connectors
- Shielded and non-shielded versions
- Straight or angled
- Easy handling
- Different codings

### Service interfaces **FrontCom® Vario**



- 100 % compatible to market standard
- RJ45 inserts according to latest Cat. 6A standard
- Clear identification thanks to large labelling surfaces
- Optional shielding via frame's earthing screw for data and signal inputs
- Various closing mechanisms, e.g. with knob or genuine security lock



## Application area

### Field wiring

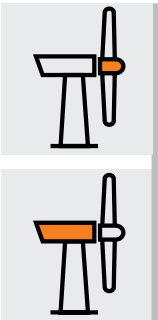

M12 power connector  
[www.weidmueller.com/m12-power](http://www.weidmueller.com/m12-power)

M12 cables with 360° shielding, over molded connectors, oil-and salt spray resistant cables, shielded connectors with fast mounting technology, Metal distributors which provided a quick and safety connection through their plug ability



M12 Signal shielded cables  
[www.weidmueller.com/m12-signal](http://www.weidmueller.com/m12-signal)

Field attachable connectors with tension clamp, screw termination, crimp and IDC technology, available in shielded and non-shielded versions, straight or angled and in different codings.

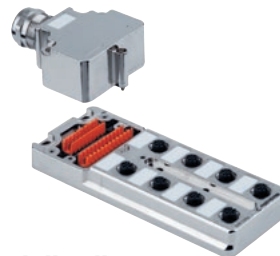

M12 metal distributor  
[www.weidmueller.com/m12-metal-distributor](http://www.weidmueller.com/m12-metal-distributor)

M12 metal distribution boxes for applications that require complete shielding from the sensors to the control. Available in 4- and 8-way versions.

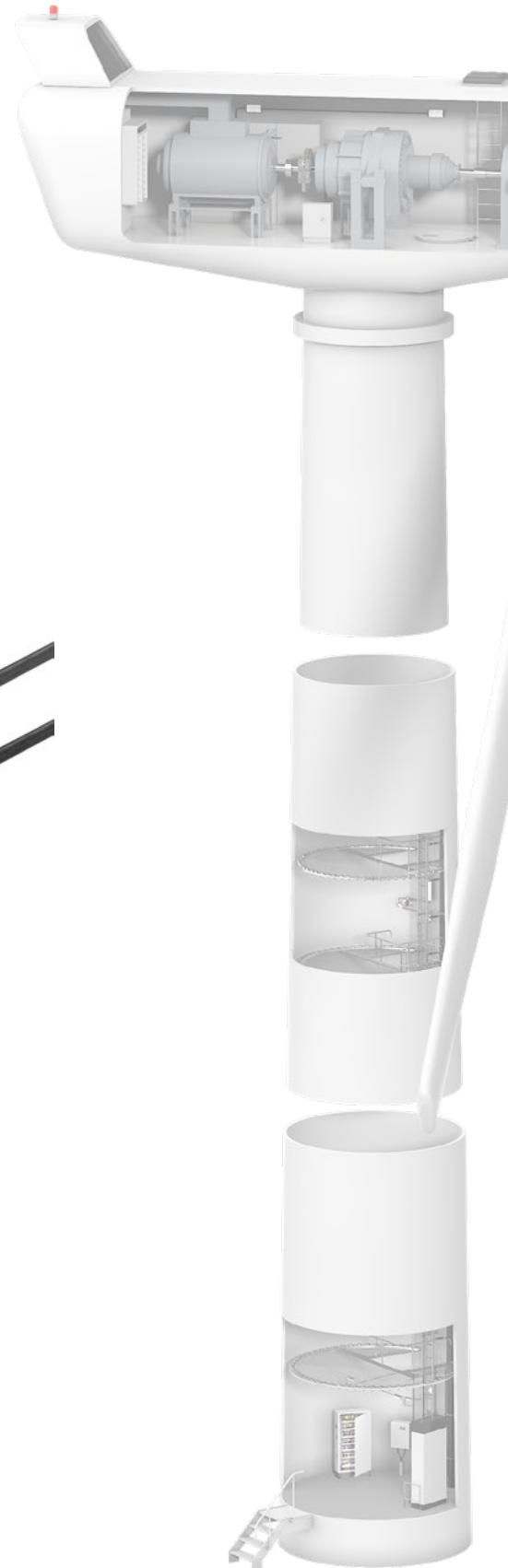

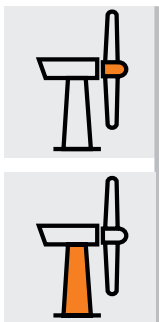
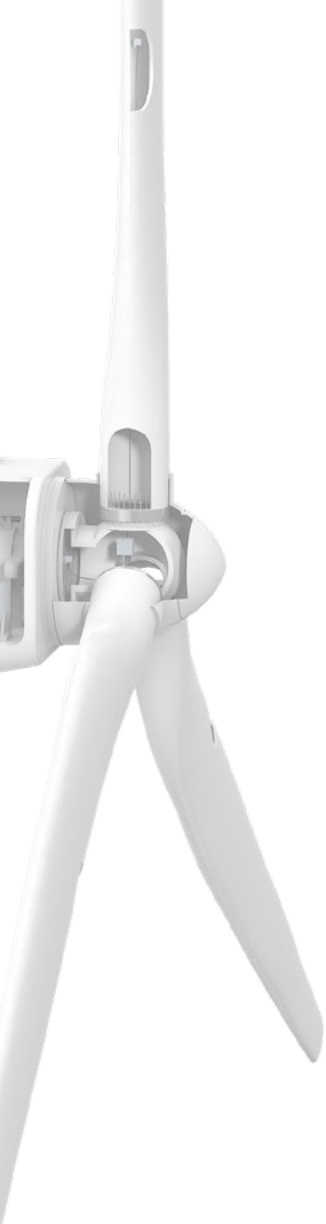

### EMC housing

[www.weidmueller.com/emc-housing](http://www.weidmueller.com/emc-housing)

The RockStar® IP65 EMC enclosures are ideal for use in the harshest environmental conditions and provide protection against electromagnetic interference. High-quality die-cast aluminum makes them particularly impact-resistant and corrosion-resistant (also for offshore use), yet compact and lightweight.



### Heavy duty inserts

[www.weidmueller.com/fixe-pole-inserts](http://www.weidmueller.com/fixe-pole-inserts)

No matter which interface you want to implement, our inserts ensure reliable electrical function. We offer nine insert families in up to twelve size.



### Modular HDCs

[www.weidmueller.com/modular-hdc](http://www.weidmueller.com/modular-hdc)

The modular connector system solves space problems by offering increased functionality with a reduced installation space. Configure frames, modules, contacts, and accessories in our online configurator.

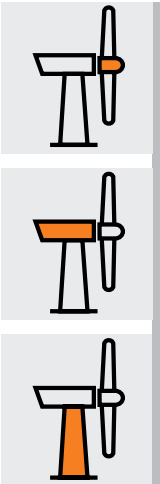

### Patch cable

[www.weidmueller.com/patch-cable](http://www.weidmueller.com/patch-cable)

The modular connector system solves space problems by offering increased functionality with a reduced installation space. Configure frames, modules, contacts, and accessories in our online configurator.



### IP20 DIN rail outlets

[www.weidmueller.com/mounting-rail-outlets](http://www.weidmueller.com/mounting-rail-outlets)

Electrical cabinet components, IP20 for copper and fibre optic cable.



### Service interfaces

[www.weidmueller.com/service-interfaces](http://www.weidmueller.com/service-interfaces)

Our modular service interface FrontCom® Vario offers the perfect combination of single or double frame, communication, and power inserts as well as the ideal insert plate



# Klippon® Connect terminal blocks

## Connection solutions for maximum availability and security



The global demand for energy is growing. At the same time, the energy industry faces the challenge of integrating renewable energies for nationwide supply. It is therefore essential to combine maximum security of supply with maximum innovative strength in order to meet the requirements of the future.

To this end, the industry relies on electrical connection solutions that ensure high availability and future-proofing. Klippon® Connect terminal blocks cover all these requirements and are at home in all areas of the energy industry. Whether conventional and regenerative generation, transmission over long distances, distribution to end users or integration in building technology. In the broad product portfolio, you will find the right solution for every application. Klippon® Connect can be flexibly adapted down to the component level and, with comprehensive certifications, guarantees maximum safety for operators, personnel and users.

### Application specific products

We offer ideal solutions for the specific wiring challenges in your wind turbine – with innovative features and unique solutions.

### Functional integration

Our product portfolio is optimally adapted to the requirements of the wind industry and focuses on functionality.

### Durable reliability

Our products are designed to ensure safety and operating efficiency for the whole lifetime of your equipment.





## Connection Technology

Increase efficiency in installation without compromising on safety

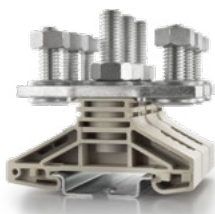

### Screw connection with stud technology

- Designed for voltage ranges up to 4,000 V and currents up to 700 A
- Extensive portfolio of one and two stud terminals
- Safe operation due to cover profiles or hinged hoods (snap-on/screwable)
- Materials comply with fire prevention regulations acc. to DIN EN 45545
- Simple handling – all that is required is a torque wrench



### Screw connection with clamping yoke technology

- Quick installation as the products are delivered with open clamping yoke
- Small „W-Compact“ module for space saving installation in the cabinet
- Protection against incorrect conductor entry
- Clippable and removable from the terminal rail in either direction
- Protection against incorrect conductor entry



### Spring connection with SNAP IN technology

- Intuitive operation of the SNAP IN technology
- Low insertion forces due to simple insertion of the stripped conductor
- Quick and easy connection even without wire end ferrule



### Spring connection with PUSH IN technology

- Release of conductor without any tool
- Flexible mounting foot for compensation of different terminal rail dimensions
- Clear differentiation of functional areas
- Slim design for large amount of cabinet space
- Vibration-resistant and gas-tight connection with copper power rails and stainless steel spring



QUICK



SIMPLE



SAFE



READY-TO-ROBOT

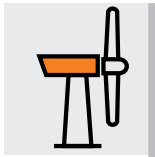

## Application area

### Terminal blocks



#### Control voltage distribution

[www.weidmueller.com/control-voltage-distribution](http://www.weidmueller.com/control-voltage-distribution)

- Easy modification and expandability
- Space saving due to six conductor connection options per terminal block
- Avoidance of incorrect wiring due to pushers

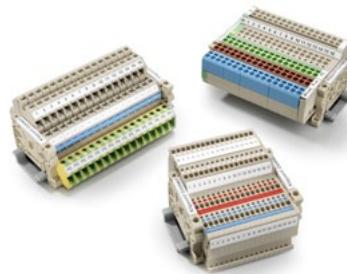

#### Signal wiring

[www.weidmueller.com/signal-wiring](http://www.weidmueller.com/signal-wiring)

- Structuring and grouping of signals in a very confined space
- Test options at every terminal point
- Up to four different potentials on one terminal with only 3.5 mm width



#### Pluggable terminal blocks

[www.weidmueller.com/pluggable-terminal-blocks](http://www.weidmueller.com/pluggable-terminal-blocks)

- Cover for protection against contamination and for maximum finger safety
- Strain relief for protection against mechanical strain
- Locking elements for highest vibration safety



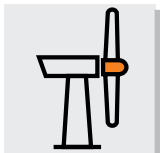
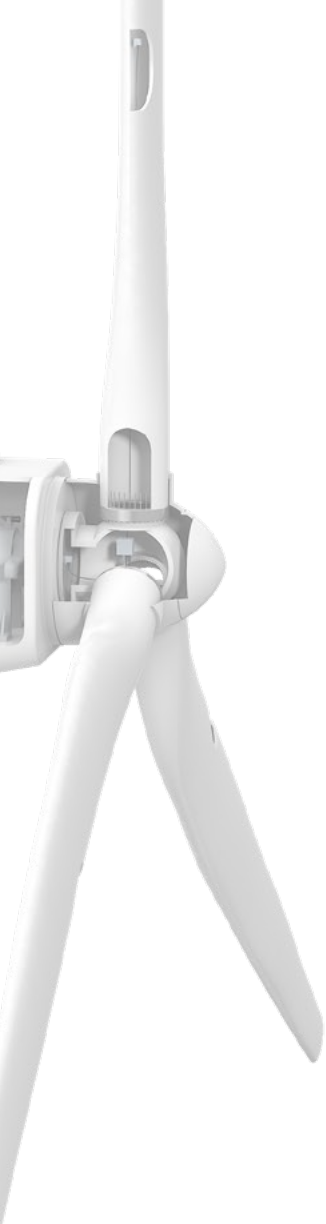

### Shielding and earthing

[www.weidmueller.com/shielding-and-earthing](http://www.weidmueller.com/shielding-and-earthing)

- Self-adjusting shield contact
- Tool-free operability
- Quick and easy assembly



### Power distribution

[www.weidmueller.com/power-distribution](http://www.weidmueller.com/power-distribution)

- Connection of aluminum and copper conductors with different cross sections
- Mounting directly or on top hat rails
- Power supply or monitoring connection



### Power feed-in

[www.weidmueller.com/power-feed-in](http://www.weidmueller.com/power-feed-in)

- Power feed-in
- Best connections in standard as well as compact design
- Uniform design reduces space requirements and accessories needed



### Instrument transformer wiring

[www.weidmueller.com/instrument-transformer-wiring](http://www.weidmueller.com/instrument-transformer-wiring)

- Safe current and voltage transformer wiring
- Integrated forced short-circuit mechanism
- Cross-connection channel upstream and downstream of the disconnection point



# Industrial Ethernet

## Safe communication inside the turbines and your park network



Weidmüller Industrial Ethernet components are the perfect link for data communication between devices in Wind industry. All our products have an extended operating temperature range and extremely high MTBF times what make them capable to withstand the harsh environmental conditions that can be found in Wind farms.

Weidmüller's wide portfolio includes compact plug-and-play unmanaged switches for the top of the turbine to collect all the necessary information from different devices and transmit it to the base of the tower. We provide high flexibility in the number and type of ports including SFP slots for fiber optic connections (both multi and single mode) and PoE variants. Complementary, our managed switches are the perfect choice for the base of the tower as they allow redundant communication topologies to be arranged between the different wind turbines of a farm, ensuring an uninterrupted data transmission with extremely low recovery times.

If any serial device has to be integrated in the Ethernet communication network of the wind farm, the right solution can be easily found in our complete family of Media Converters.

Weidmüller routers bring also important benefits as, together with our u-link cloud service, can be the secure entrance door to wind farms located in remote areas (possibility of cellular connection via 4G LTE). Security and simplicity are the key features of our remote access solution based on VPN connections.

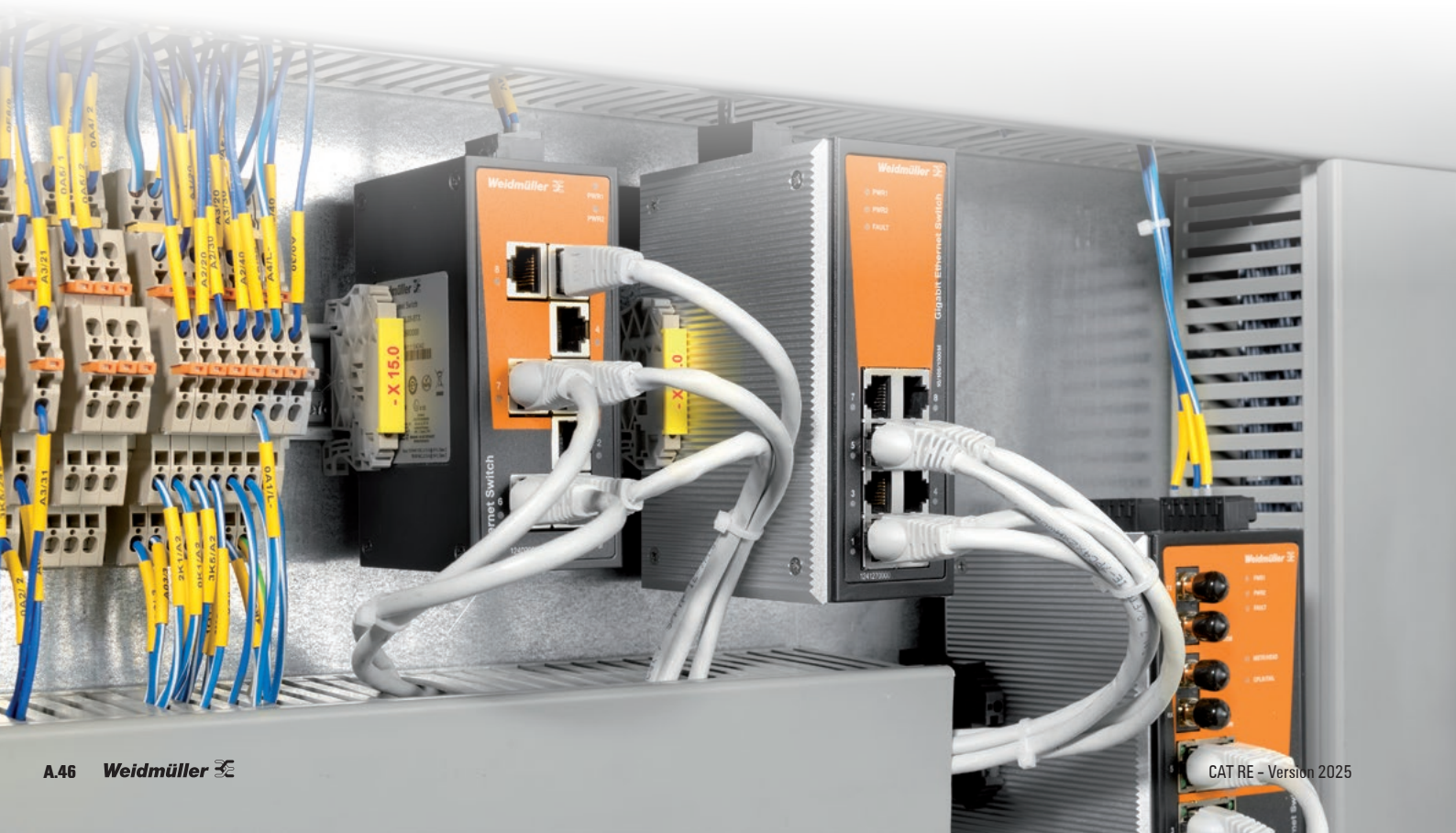



## Industrial Ethernet

Transfer industrial data reliably and flexibly between your turbines and park network

### Unmanaged Switches BasicLine Series B



- Temperature range from -40 to +75°C
- Extensive range of model variants with SFP ports for fibre optic communication
- Maritime approvals and models with coated circuit boards for offshore applications
- Compact and robust metal housing
- PoE++ models with up to 60 W per port \*soon
- Profinet Conformance Class A and LLDP Blocking

### Managed Switches AdvancedLine



- Temperature range from -40 to +75°C
- Extensive range of model variants with SFP ports for fibre optic communication
- Profinet Conformance Class B certified
- Comprehensive security features
- VLANs
- ACL
- Port Lock
- RADIUS and TACACS authentication
- Redundancies (RSTP, MRP, O-Ring, O-Chain...)
- Monitoring (SNMP, Modbus TCP, Port Mirroring)

### Industrial Security Router



- Stateful packet inspection firewall on layer 2, 3 and 4)
- Integrated VPN u-link remote access (ISO 27001 certified)
- Expanded temperature range of -30 to +70 °C (model-specific)
- Comprehensive network management functions (DNAT, SNAT, 1:1 NAT)
- Models with DMZ function
- Reliable internet connection with integrated 4G/LTE wireless modem

## Application area Industrial Ethernet

A



### Nacelle and hub

Controls in the various applications of a wind turbine require secure data transfer in a secure plant network. Weidmüller's Industrial Ethernet Switches organize the communication and priority of the data and forward it to the main control system of the wind turbine. The broad product portfolio in the area of IE communication includes managed or unmanaged switches based on copper or fiber optic cables. The extensive router portfolio enables secure connections to and from the turbine network.

Many of the IE products meet the extreme requirements in the wind sector such as temperature, climate change, vibration and shock in your wind turbine and ensure trouble-free and reliable communication.

### Tower base

The plant network extends from the nacelle via the hub to the tower base, so that all communication-capable products can also be integrated in the tower base. Copper-based communication (nacelle/hub), can be converted to fiber-optic communication to safely bridge longer distances. For data communication over longer distances, the Weidmüller IE portfolio offers the right products with their switches and fiber optic interfaces. In this application, too, the routers provide secure access out of or into the plant network.

Weidmüller's IE products with their standardized interfaces thus also offer communication in the park network with the highest data security requirements.

### Park communication

Weidmüller also offers a comprehensive IE portfolio outside the WTG, i.e. in the park network, so that communication from the park server to the pitch control is ensured. Weidmüller's universal IE portfolio with defined interfaces and extensive technical features provide the basis for secure communication even under special climatic conditions.

The Weidmüller remote access solution u-link guarantees a quick and secure access to wind turbines, while also allowing for efficient management of production plants, user clients, access rights or firmware versions.



Hub and nacelle

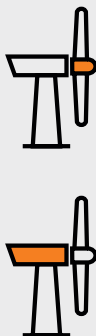

**Managed Switches AdvancedLine**

Type	Order No.
IE-SW-AL05LM-5TX	2682250000
IE-SW-AL08M-8TX	2682280000
IE-SW-AL08M-6TX-2GT	2682290000
IE-SW-AL08M-8GT	2682350000
IE-SW-AL16M-16TX	2682310000
IE-SW-AL24M-24TX	2682320000
IE-SW-AL08M-8GTPOE	2682420000



**WLAN**

Type	Order No.
IE-WLT-BL-AP-CL-EU	2536650000
IE-WLT-VL-AP-BR-CL-EU	2536690000

Macelle and tower

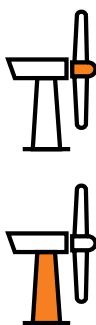

**Serial/Ethernet Converters and Modbus gateway**

Type	Order No.
IE-CS-MBGW-2TX-1COM	2682600000
IE-CST-2TX-1RS232/485	1285830000
IE-CST-2TX-2RS232/485	1285840000



**Managed Switches**

Type	Order No.
IE-SW-AL10M-8TX-2GC	2740420000
IE-SW-AL14M-12GT-2GESFP	2682360000
IE-SW-AL18M-16TX-2GC	2682330000
IE-SW-AL06M-4GTPOE-2GESFP	2682430000



Tower base



**Security Routers**

Type	Order No.
IE-SR-4TX	2751270000
IE-SR-4TX-LTE/4G-EU	2751280000
IE-SR-4TX-LTE/4G-USEMEA	2739630000
IE-SR-4GT	2873910000
IE-SR-4GT-LTE/4G-EU	2873920000
IE-SR-4GT-LTE/4G-USEMEA	2873930000
IE-SR-4GT-M	2990450000



**Managed Switches**

Type	Order No.
IE-SW-AL12M-8GT-4GESFP	2682340000
IE-SW-AL24M-16GT-8GESFP	2682370000



**u-link remote access service**

- ISO 27001 certified
- No IT expertise required
- Comprehensive functions
- Safely scalable

Type	Order No.
U-LINK-50-DEVICES-1Y	2870090000
U-LINK-1-CONNECTION-1Y	2870130000

**NOTE:** Selected list of articles shown but much larger available number of products in our online catalogue!



# Tailwind for your project

## Customised solutions for different ambient conditions

Assembled housing solutions are being used in more and more production areas within industrial applications in order to reduce the vertical range of manufacture and save on production costs. And the same applies for the production of modern wind power installations. We provide custom-assembled solutions of the highest quality for connection to the supply system, control systems, a range of testing and service units, and protection and safety equipment. These allow you to significantly improve the performance, durability and service friendliness of your turbines while also reducing assembly costs. And the best thing about all this is that our assembly service makes sure that all relevant factors are taken into account right from the outset.

Connection box  
Lubrication / LED lighting



Condition monitoring box  
for bolted joints



Arrester box



Connection box for  
communication

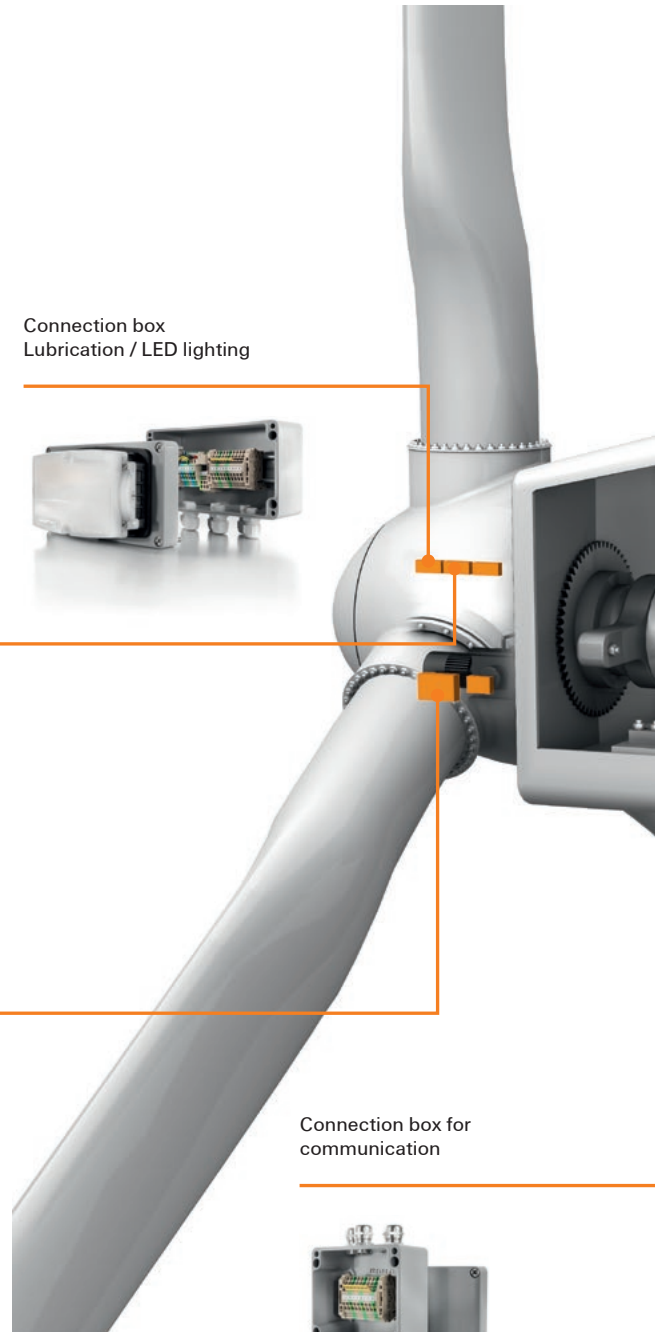
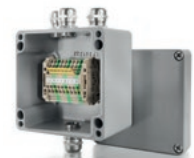

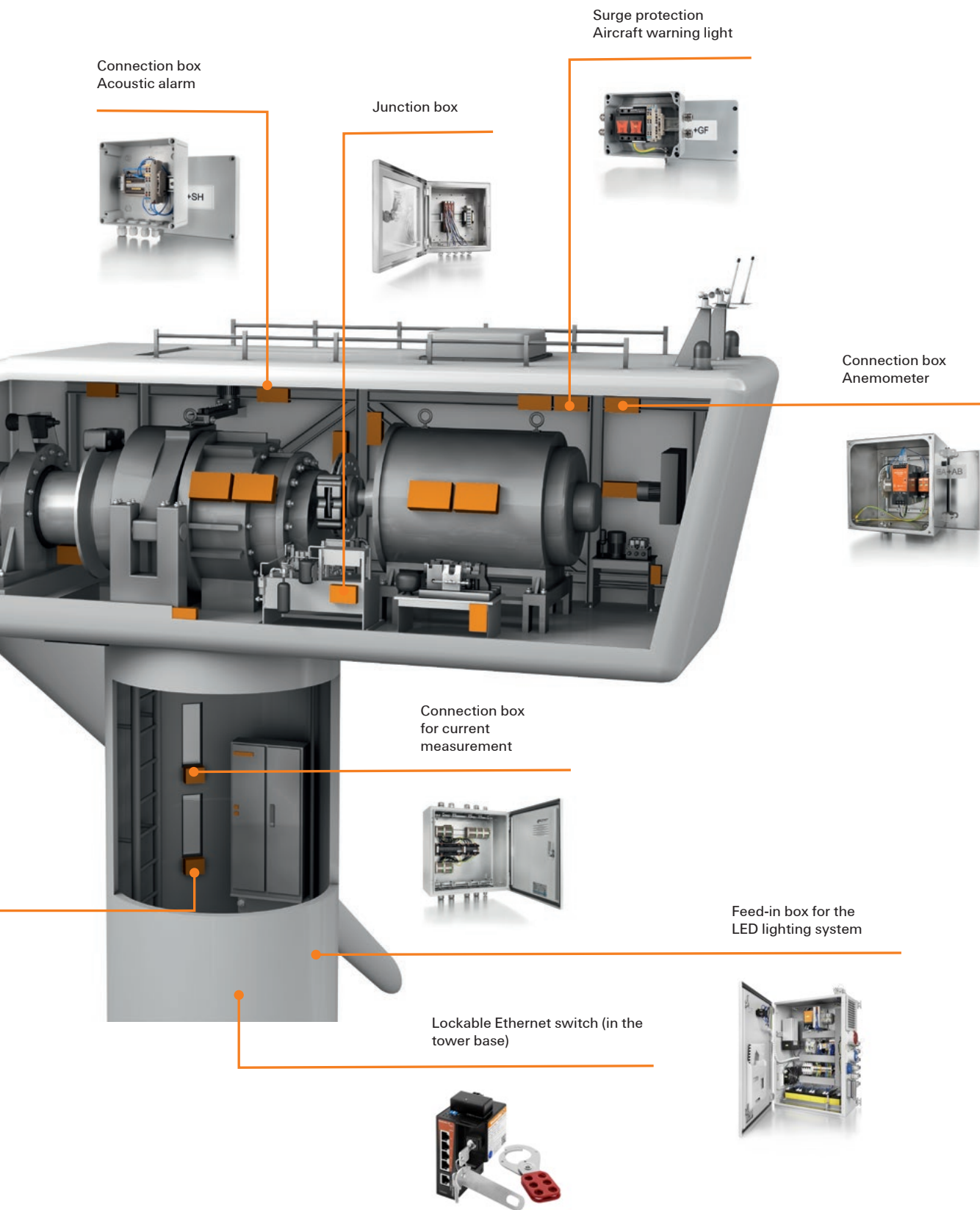

## Tailwind for the energy transition

### Lanthan Safe Sky and Weidmüller are sustainably retrofitting wind power installations



The retrofitting of wind farms with so-called “Aircraft Detection Lighting Systems” is coming along at a fast pace. According to legislation, onshore wind power installations should be equipped with this technology by 1 January 2024, and offshore plants the following year. Two industry pioneers, who are working closely together to ensure rapid change, are at the forefront: Lanthan Safe Sky and Weidmüller.

With Aircraft Detection Lighting Systems, signal lights on wind power installations are only activated when an aircraft or helicopter approaches the wind farm. The transponder signal of the aircraft and the receiver of the wind power installation communicate every second. This technology reduces the nightly flashing of the installations by up to 98 percent. This minimises night-time light pollution and represents an important step towards the energy transition.

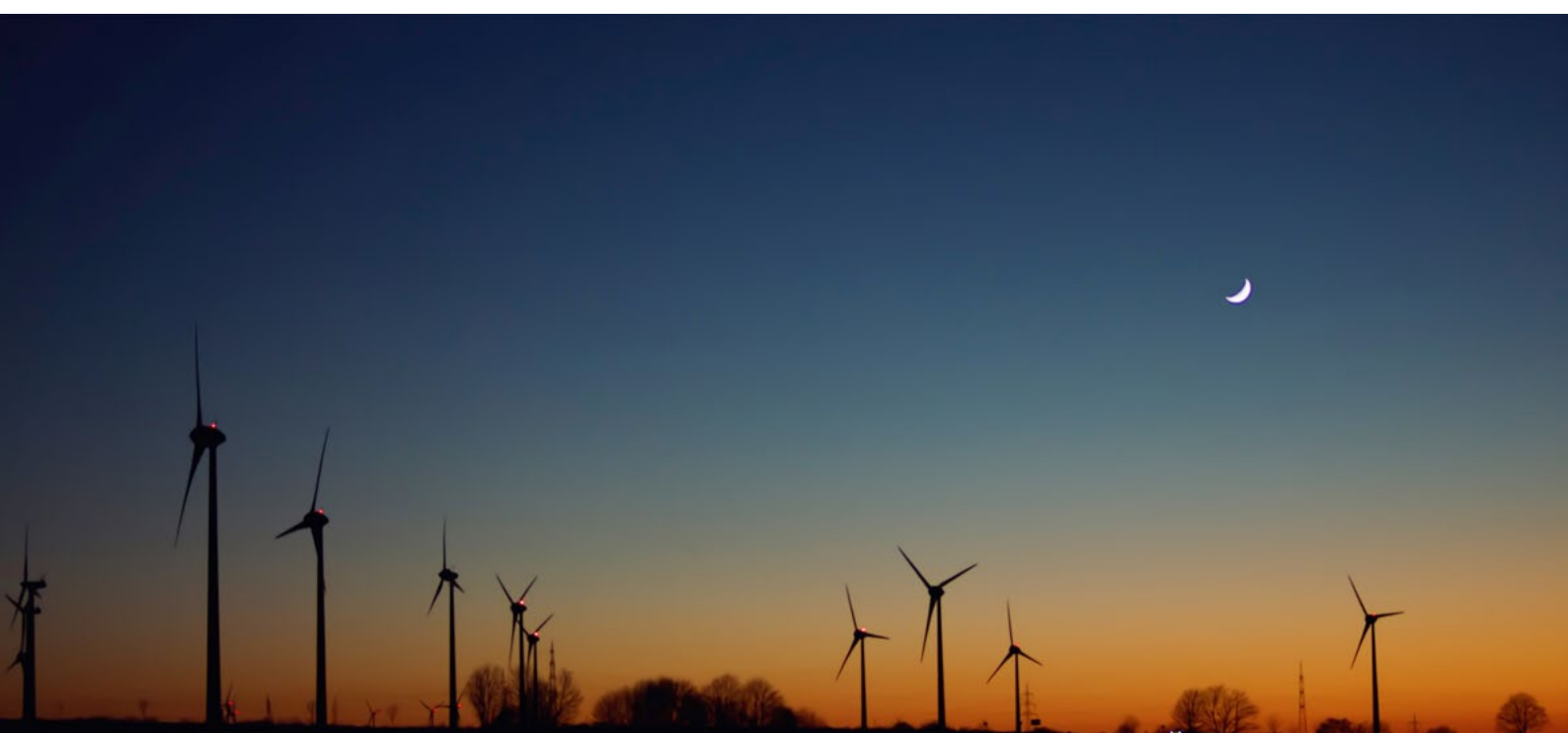



### Ready-to-use, holistic ADLS concepts

The Lanthan Safe Sky joint venture is one of the first approved manufacturers to develop and market ADLS. As a provider of solutions for all aspects of industrial connectivity, Weidmüller produces individual applications that are perfectly tailored to the traffic detection of the ADLS technology provider. The project involves the production of stainless-steel enclosures that are equipped and wired with Lanthan Safe Sky components and Weidmüller electrical components - a turnkey solution.

“We feel that it is important to bring a system to the market that meets the requirements to ensure comprehensive deactivation of the red warning lights on wind power installations” says Hans Schlingmann, Vice President of the Wind Business Unit. The ready-to-use solution is produced in Detmold and can be installed directly into the wind power installations by Lanthan Safe Sky customers.

### Customer-specific solutions for the wind industry from Weidmüller

“For years we have been a flexible partner for the production and development of customer-specific solutions in the wind industry,” emphasises Schlingmann. “Thanks to many years of experience in the industry and relevant certifications, Weidmüller is able to implement such future-proof projects in close collaboration with its customers”, states the business unit manager.

The current project is just one example; other solutions ranging from simple connectivity to data collection and analysis are possible. “Weidmüller has the necessary expertise from its product line”, adds Schlingmann.

### With innovations for greater acceptance of renewable energies

The construction of new power generation plants often meets with resistance in the population - and wind farms are no exception to this. These are often perceived as a disturbance factor and a source of danger: Changing the landscape, endangering wild birds, casting shadows and noise pollution are just some of the arguments put forward by residents.

But wind power installations make a significant contribution to the energy transition. The innovative technology from Lanthan Safe Sky is intended to increase the popularity of wind farms, thus making electricity generation in Germany even more sustainable. “In the fight against the climate crisis, we don’t just need installations that produce more clean energy at lower prices, but also innovations that improve the acceptance of wind energy”, outlines the business unit manager.

## Caribbean flair for BLADEcontrol®

On Guadeloupe, six LEITWIND turbines of the type LTW80 1.65MW Typhoon have been equipped with the BLADEcontrol® rotor blade monitoring system



A particularly exciting project for the Weidmüller team was the repowering of the Fonds Caraïbes – Quadran wind farm by POMA-LEITWIND. On Guadeloupe, 20 wind turbines from the early 2000s were replaced. Back in 2019, Italian wind turbine manufacturer LEITWIND developed a wind turbine with rotor blades that can withstand extreme hurricane force winds. This new LS39-H rotor blade was finally to celebrate its première on the French island of Guadeloupe.

“Warm and humid days, violent storms and a high salt content in the air are characteristic of the coastal location there and increase the complexity of this unique project. In light of these special wind and weather conditions, it is even more important to reliably detect damage and loads in order to be able to initiate appropriate measures at an early stage”: that is how the project team explains LEITNER AG’s decision in favour of **BLADEcontrol®**.

Installation work with the main crane on a LEITWIND wind turbine of the type LTW80 1.65MW Typhoon





### From India to the West Indies

The complexity of the project was already apparent during the preparation of the quotation, in which we were always able to react flexibly to the requirements and wishes. The final decision was made to ship the individual parts of the **BLADEcontrol®** separately so that they could be installed in the wind turbine components at the respective LEITWIND plants in advance.

Our service technician Hans Reps showed great commitment in India. The installation of the blade sensors and training of the LEITWIND colleagues took place directly in the blade plant near Chennai. He and his colleagues from Germany, Tyrol, Spain and the Ukraine had to cope with the high temperatures in the morning. But the technicians on site were always ready to assist. They were thoroughly amused when Hans unexpectedly startled a green snake on its way to the rotor blade.

Despite the many different dialects from Europe and India, the blades were successfully equipped with our sensor technology according to schedule. Then they were shipped to the Caribbean.

### Another challenge was the demanding schedule on Guadeloupe

During installation and commissioning on site, all work has to be carried out before the hurricane season. Unfortunately,

the fickle weather does not adhere to forecasts. For example, the blades had to be temporarily stored during a typhoon. And due to restrictions on shipping, the large components of the wind turbines, as well as the erection crane, could only be delivered by cargo ship at night.

Thanks to the best possible and careful planning, new customised solutions and also thanks to the good cooperation with various suppliers and partners, POMA-LEITWIND and Weidmüller were able to successfully master all challenges.

**BLADEcontrol®** is Weidmüller's solution for monitoring rotor blades. It continuously records the condition of each individual rotor blade and notices even small changes: around the clock, 365 days a year. Problems are identified much earlier than with visual inspections, and it prevents damage from progressing in an uncontrolled manner. If damage occurs, this causes high repair costs, especially on an island.

### Early damage detection through tried-and-tested condition monitoring

The sensitive sensor system detects damage right from its initial stages. For this purpose, precise measurements are carried out in the natural vibration behaviour of the rotor blade. This type of detection detects even damage that is invisible from the outside and works reliably under all weather conditions.



BLADEcontrol® hardware components



Hans Reps, service technician at Weidmüller, accompanied the project on site



Typical damage to the rotor blade includes blade tip damage caused by lightning strikes, trailing edge cracks, web separation and blade bearing damage. Only in the case of serious damage does BLADEcontrol® send a signal to the turbine control system, which can then stop the turbine immediately and prevent blade breakage.

In addition to direct damage to the rotor blade, operating deviations such as aerodynamic imbalances, loose parts in the blade and hub, as well as pitch misalignments and yaw overloads are also detected. The system thus makes an additional contribution to the operational reliability of the turbine and helps improve the energy yield.

#### **Web-based visualisation**

All detected damage is simultaneously transmitted to the Weidmüller Monitoring Centre, where experts evaluate the data and prepare specific action recommendations for

operators. You can find out about the turbine status of the rotor blades at any time via online monitoring with WebVis.

**BLADEcontrol®** has been certified as an ice detector since 2008 and as a monitoring system for damage detection on rotor blades since 2013.

#### **Successful cooperation worldwide**

Projects like the one in Guadeloupe require close communication with all partners, detailed planning and a high degree of flexibility. This makes us all the more pleased and proud of this successful and friendly cooperation. The Quadran wind farm on the French Overseas Department is our first project in the Caribbean and has delighted all employees at the Dresden site. Especially in these times, wanderlust is particularly strong.

[www.weidmueller.de/bladecontrol](http://www.weidmueller.de/bladecontrol)



# AI-based anti-collision system for wind turbines

## Cooperation for bird protection



Weidmüller is supplying customised enclosure solutions for ProTecBird's AI technology for bird protection at wind power installations. The partnership between Weidmüller and ProTecBird sets new standards in the field of bird protection and renewable energies. The focus is on the industrialisation of the customised, AI-based anti-collision system that ProTecBird has designed specifically for wind power installations. This cooperation shows how technological innovation and environmental awareness can go hand in hand to promote both the expansion of wind energy and the protection of wildlife.

For years, Weidmüller has been a flexible partner for the production and development of customised solutions in the wind industry. Thanks to this experience and the corresponding certifications, Weidmüller is able to realise such projects in close cooperation with the customer.

### Strong partnerships for high customer benefit

ProTecBird specialises in species and environmental protection. With its AVES systems, the company offers innovative, AI-based solutions. AVES Wind Onshore uses an AI-based camera system to detect birds, track their flight path and, if a collision is imminent, set the rotor blades of the wind turbines into idle mode until the bird leaves the area again. This approach enables an effective reduction in bird strikes and at the same time contributes to accelerating the use of renewable energies.

### Responsibility and progress for the wind industry

In the offshore sector, AVES Monitoring offers a powerful tool for collecting and analysing avifaunistic data. This comprehensive data collection enables the creation of precise risk models in order to fulfil official requirements in a correct manner. Furthermore, ProTecBird contributes to the flight safety of aircraft taking off and landing with AI-based and fully automated deterrence systems and protects industrial buildings, power plants, offshore facilities and football stadiums from pollution and damage caused by birds.



Visualisation of bird detection by AVES Wind anti-collision system with species recognition AI with indication of probability



AVES Monitoring Offshore enables the detailed monitoring and analysis of bird migration



In close cooperation with ProTecBird, Weidmüller is responsible for the industrialisation of the current systems. The specific requirements of the onshore and offshore wind industry are the guiding principles here. Weidmüller is contributing its expertise in mechanical and electrical design to develop a modular system that meets the specific requirements of the wind energy industry.

### Customised Weidmüller enclosures for the highest demands

Among other things, the collaboration aims to develop stainless steel enclosures for ProTecBird's camera system and speakers, which are equipped with Weidmüller products according to the individual requirements of ProTecBird.

The partnership between Weidmüller and ProTecBird not only promotes the protection of species, but also clears the way for a faster growth of wind energy.



This co-operation impressively demonstrates how innovative approaches and strong partnerships can help to master the challenges of the future and at the same time demonstrate ecological responsibility.

## Our complementary solutions

The u-control modular controller for industrial automation and IoT applications, for example, is used in the development of the customised solution for ProTecBird. u-control is one of the most compact and modern control systems on the market. The powerful I/O system u-remote is also installed in the enclosures. The modular and space-

saving system impresses users with its intuitive handling on both the software and hardware level. Remote maintenance is made possible by Weidmüller's Industrial Security Router u-link. Industrial Ethernet, power supply units and connection technology complete the range of products used.



#### u-link

The u-link remote access service from Weidmüller enables simple and secure remote maintenance



#### u-control

The modular control system for industrial automation and IoT applications u-control from Weidmüller



#### u-remote

Weidmüller's modular, space-saving and high-performing I/O system u-remote

## BLADEcontrol® Condition Monitoring Services

### Protection against major damage of offshore rotor blades



Offshore wind turbines are seen as the key to the expansion of wind energy. However, even the most advanced turbines are not safe from damage. Rotor blades are among the most heavily stressed components. Failure rates for offshore wind turbines are generally four times higher than for onshore turbines. This is where **BLADEcontrol®** from weidmüller offers significant added value for turbine operation, because the failure of offshore wind turbines in particular is especially serious, as they produce large amounts of electricity almost continuously and repair work is always very cost-intensive due to their accessibility.

»For an offshore turbine in the 12 MW class, the loss of revenue per day amounts to approx. 18.000 euros. In the case described above, the downtime could be reduced by 50 to 70 days due to preventive damage detection – compared to a potential blade loss – depending on the availability of crane vessels

Dr. Daniel Schingnitz, Head of Sales and Marketing at Weidmüller Monitoring Systems GmbH





### Condition Monitoring Services from BLADEcontrol®

The **BLADEcontrol®** Condition Monitoring System (CMS) is able to recognise critical damage to rotor blades at an early stage before a failure occurs. The CMS uses highly sensitive sensor technology to detect even the smallest changes to rotor blades and their structure. In addition to providing the hardware and software, Weidmüller Monitoring Systems also offers a monitoring service. The service includes data-based 24-hour monitoring of the rotor blade status.

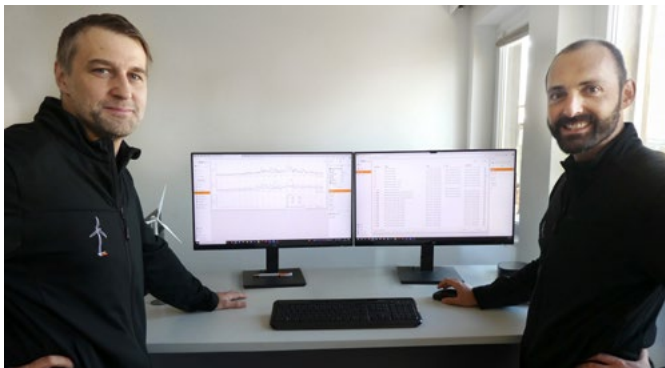

Damage analysis by our monitoring experts

stage. A detailed analysis of the measurement data led to the clear identification of the cause of the damage, a crack on the surface of the rotor blade. After reporting the event to the operator and a subsequent visual inspection, the crack was confirmed as the cause of the measurement deviation. The CMS was used to monitor the further development of the longitudinal crack until the defined threshold value was reached. When this value was reached, the customer was informed directly.

The Weidmüller online portal WebVis clearly shows the deviating vibration behaviour of the affected blade (green).

In close consultation with our monitoring team, the customer decided to shut down the system and plan and carry out a repair. By recognising the damage at an early stage, a possible breakage of the rotor blade and thus a long-term failure of the entire turbine could be avoided. Subsequent events, such as imbalances occurring in the turbine, increased vibration behaviour of the rotor blades, parts breaking off and the resulting environmental pollution, were also reliably averted. The advantage for our customer was a significant reduction in repair costs for the installed blade compared to a complete rotor blade replacement. In addition to the savings in repair costs, the early detection of damage also prevented increased yield losses due to long downtimes.

### Typical deviations in vibration behaviour: Crack in the rotor blade surface

In this case, our experts from the monitoring team recognised a noticeable vibration deviation on one rotor blade compared to the other two blades at an early

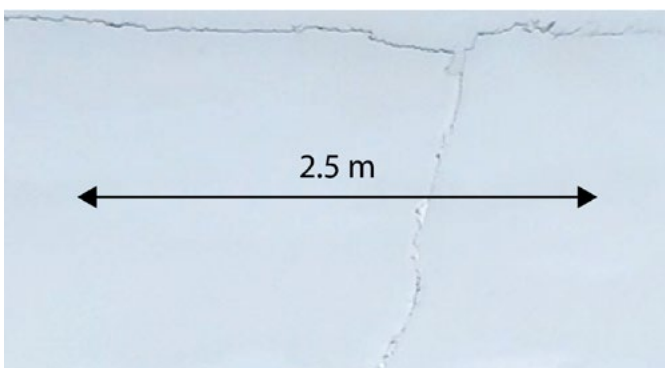

Crack in the rotor blade

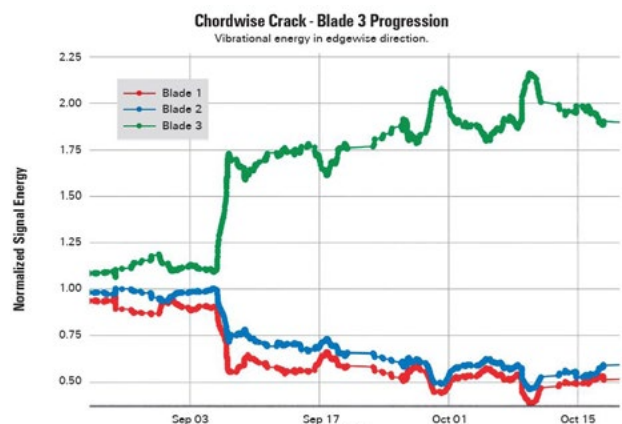

Graphical representation of the damage event in the WebVis online portal



### Avoid loss of earnings in the six-figure range

For an offshore turbine in the 12 MW class, the loss of revenue per day amounts to approx. 18.000 euros. In the case described above, the downtime could be reduced by 50 to 70 days due to preventive damage detection - compared to a potential blade loss - depending on the availability of crane vessels. The costs for a new rotor blade and the corresponding logistics are not taken into account.

The use of **BLADEcontrol**<sup>®</sup> has been proven to make maintenance more predictable and avoid expensive repairs. This leads to an increase in energy yield and a reduction in

operating costs over the entire service life of the turbines. Around 5,450 onshore and 450 offshore wind turbines are currently equipped with the **BLADEcontrol**<sup>®</sup> system.

Dr Daniel Schingnitz, Head of Sales and Marketing at Weidmüller Monitoring Systems GmbH, says: 'With over 24.200 machine years of experience, we are the experts in the field of rotor blade monitoring. The algorithms and the system around **BLADEcontrol**<sup>®</sup> are continuously being developed and supplemented with new measurement data. Our customers, including the world's largest manufacturers and operators of wind turbines, have been convinced by our range of solutions for 20 years.'

# Photovoltaics

<b>Photovoltaics</b>	Introduction	B.2
	Solutions for rooftop PV systems	B.3
	Solutions for utility scale PV systems	B.17
	PV accessories & components	B.44
	Success stories	B.54
	Proven competence	B.58
	Tested quality	B.59



# Solutions for Photovoltaic Systems

## Long-term profitable, effective running systems

### B

Weidmüller offers a wide range of combiner boxes, monitoring solutions and components for large-scale PV projects and rooftop systems to meet your individual requirements: Benefit from our many years of experience in the photovoltaic industry, the know-how of our experts and our global network.



For further information, technical specifications or additional services, please visit our website: [www.weidmueller.com/pv-solutions](http://www.weidmueller.com/pv-solutions)



**Connection & combination**  
Connection & Combination of PV strings from field or array



**Protection**  
Protection against surges and touching



**Monitoring**  
Monitoring of string performance and component status



**427 T**  
Combiner boxes sold



**251 M**  
Supported modules



**100**  
Countries with local support

# Install and safeguard PV systems on the roof

## Easy. fast & safe. installation

Our mission toward the energy transition: We want to make the installation of PV systems on the roof easier, faster and safer for installers. For this reason, we offer an extensive range of PV combiner boxes, surge protection devices, connectors, tools and components.

The combiner box product family PV Next offers standard variants for DC-side protection of the installation between PV panel and inverter. At the same time, PV strings can be combined in the boxes to reduce the amount of cabling required.

Get to know our photovoltaic products for rooftop systems here and find many more tips on photovoltaic installation.



For further information, technical specifications or additional services, please visit our website:  
[www.weidmuller.com/pv-rooftop](http://www.weidmuller.com/pv-rooftop)



# PV Next Combiner Box

## Easy, fast, and safe wiring of photovoltaic systems

B



With PV Next, Weidmüller offers the world's first combiner box concept based on a standardised printed circuit board design. This concept is not only very robust, but also reduces the use of materials such as copper and plastic by 25%. At the same time, the design enables an easy, fast and safe installation. The integrated PUSH IN technology, for example, reduces installation times and minimises the risk of errors and the resulting consequences.

### Many different variants for commercial and residential buildings from stock

PV Next is protecting the PV system against overvoltages and reverse currents and also offers the possibility to combine strings. The various designs are done to protect all string inverters available in the European market.



For more information, visit our website:  
[www.weidmueller.com/pvnext](http://www.weidmueller.com/pvnext)

PV Next protects and combines PV strings



Suitable for commercial and residential buildings.

## Standardised printed circuit board design – one design for all applications

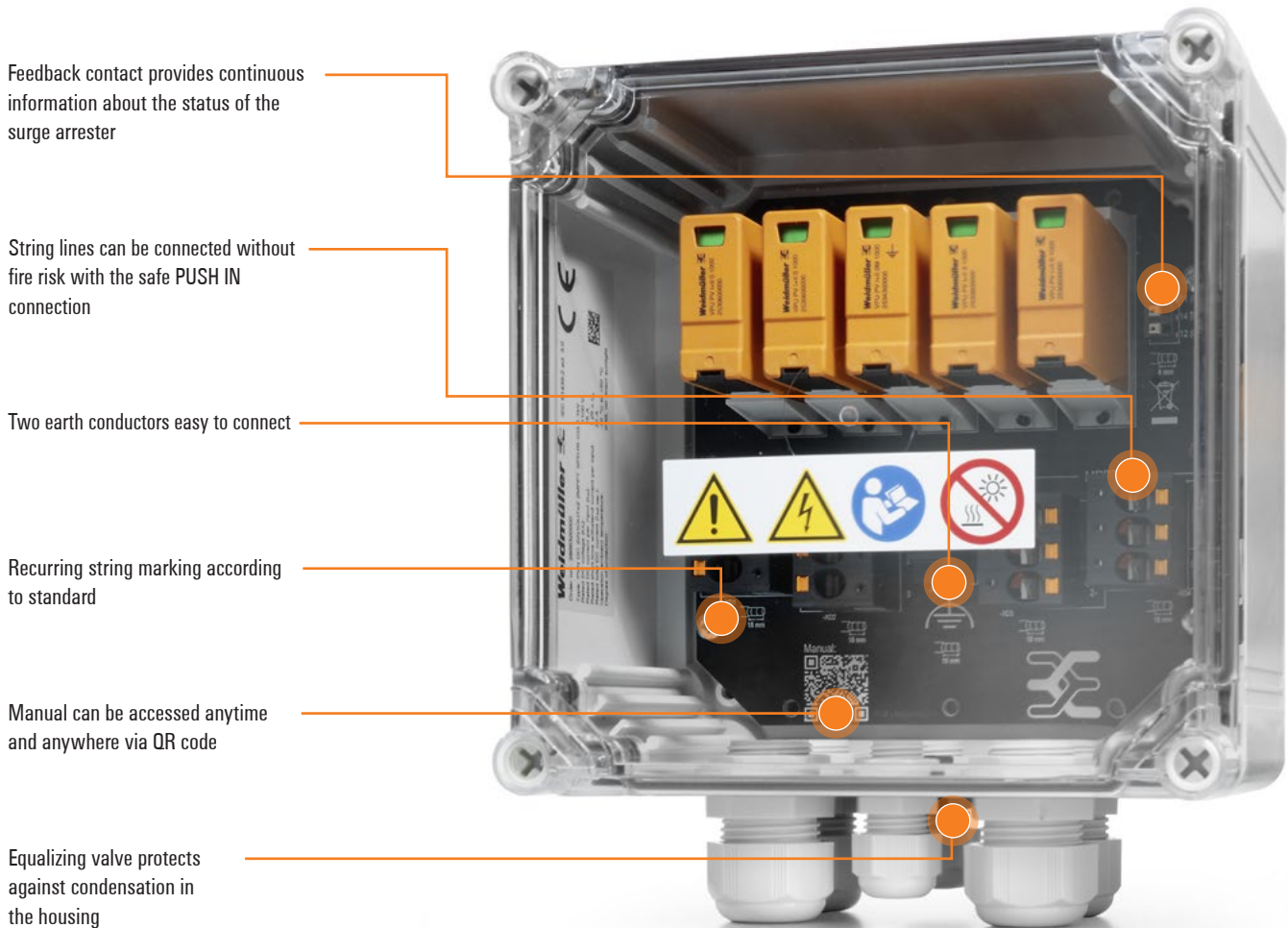

B



### The most innovative concept for string inverters



Tested according to IEC-61439-2 standard in accredited laboratory



High input current even at 50°C ambient temperature



3D data available online



Certified according to protection class IP65



Combination of strings saves time and wiring



Suitable variants for every installation type

# The right combiner box for your inverter type in just three steps

**B**



## 1. Select your inverter type

Open our online selector via the QR code or short link to the right. Select the manufacturer and type of your inverter here. You will then receive a pre-selection of suitable products for your PV installation.



Here you can access the online selector, which provides the basis for your selection:  
[www.weidmuller.com/pvselector](http://www.weidmuller.com/pvselector)

## 2. Determine the standard-compliant surge protection

Answer the questions in the table below from left to right to determine what surge protection is needed on both the DC and AC sides for your installation. The diagram maps:  
 (1) at the entry point of the PV cables into the building (inside or outside),  
 (2) at or in the inverter (DC side), (3) at or in the inverter (AC side), (4) in the main distribution. If the cable length is more than 10 m, you need an additional overvoltage protection according to the standard EN 51643-32. Our PV Next combiner boxes protect the DC side of the installation. That's why they are highlighted here.

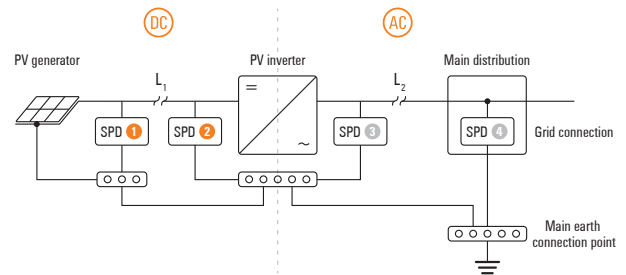

				DC		AC	
Question 1: External lightning protection system present?	Question 2: Separation distance maintained?*	Question 3: Cable length $L_1$ larger than 10 m?	Question 4: Cable length $L_2$ larger than 10 m?	Installation locations		Installation locations	
				SPD 1	SPD 2	SPD 3	SPD 4
no	-	yes	yes	Type II DC	Type II DC	Type II AC	Type II AC
no	-	no	yes	-	Type II DC	Type II AC	Type II AC
no	-	yes	no	Type II DC	Type II DC	-	Type II AC
no	-	no	no	-	Type II DC	-	Type II AC
yes	yes	yes	yes	Type II DC	Type II DC	Type II AC	Type I AC
yes	yes	no	yes	-	Type II DC	Type II AC	Type I AC
yes	yes	yes	no	Type II DC	Type II DC	-	Type I AC
yes	yes	no	no	-	Type II DC	-	Type I AC
yes	no	yes	yes	Type I DC	Type I DC	Type I AC**	Type I AC
yes	no	no	yes	-	Type I DC	Type I AC**	Type I AC
yes	no	yes	no	Type I DC	Type I DC	-	Type I AC
yes	no	no	no	-	Type I DC	-	Type I AC

\*Between PV installation and external lightning protection, according to standard EN 51643-32.

\*\*If the inverter and the main distribution board are connected to the same grounding busbar via a grounding cable whose length does not exceed 0.5 m, no SPD is required at installation location "3".

### 3. Select your preferred connection type

All PV Next variants are available with WM4 C ("Weidmüller connector"), MC4 EVO2 ("Stäubli connector") or CG ("classic cable gland") connection types. The housing interior has practical 16 mm<sup>2</sup> PUSH IN connections. Select the product variant with your preferred connection type in the selector.



Now that you have found the right product, you can send us your product request directly from the selector or order the part number from your trusted dealer.

#### Examples of the perfect combination\*

Here you will find common combinations for inverters from SMA, Fronius, SolarEdge and Huawei. You will find many other inverter manufacturers and types in our online selector.



**SMA Sunny Tripower CORE1**  
6MPP, 2IN



**PV Next**  
Order No. 2737620000



**Fronius Symo GEN24 Plus**  
2MPP, 2IN/1IN



**PV Next**  
Order No. 2866340000



**SE3K**  
1MPP, 2IN



**PV Next**  
Order No. 2890560000

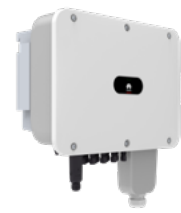

**Huawei SUN2000-30/36/40KTL-M3**  
4MPP, 2IN



**PV Next**  
Order No. 2737610000

\*Variants for type I/II and WM4C connector; for further variants, go to our homepage at [www.weidmueller.com/pv-perfect-match](http://www.weidmueller.com/pv-perfect-match).





## PV Next combiner boxes for commercial PV systems

Type	MPP	Inputs per MPP	Outputs per MPP	Surge protection requirement class	Connection	Qty.	Order No.	
<b>No fuse holder, no switch-disconnector</b>								
PVN DC 3I 30 3MPP SPD1R WM4 11	3 MPPT	3 Inputs	3 Outputs	Type: I / II	Connector, WM4C	1	2890460000	
PVN DC 3I 30 3MPP SPD1R CG 11	3 MPPT	3 Inputs	3 Outputs	Type: I / II	Cable gland, PUSH-IN connection	1	2890580000	
PVN DC 3I 30 3MPP SPD1R EVO 11	3 MPPT	3 Inputs	3 Outputs	Type: I / II	Connector, MC4-Evo 2	1	2890340000	
PVN DC 2I 10 4MPP SPD1R WM4 11	4 MPPT	2 Inputs	1 Output	Type: I / II	Connector, WM4C	1	2737600000	
PVN DC 2I 10 4MPP SPD1R CG 11	4 MPPT	2 Inputs	1 Output	Type: I / II	Cable gland, PUSH-IN connection	1	2737610000	
PVN DC 2I 10 4MPP SPD1R EVO 11	4 MPPT	2 Inputs	1 Output	Type: I / II	Connector, MC4-Evo 2	1	2975590000	
PVN1M6I4SXFV101TXPX10	6 MPPT	2 Inputs	1 Output	Type: I / II	Connector, WM4C	1	2737620000	
PVN1M6I4SXFV100TXPX10	6 MPPT	2 Inputs	1 Output	Type: I / II	Cable gland, PUSH-IN connection	1	2737630000	
PVC DC 2I 10 10MPP SPD1R WM4 11	10 MPPT	2 Inputs	2 Outputs	Type: I / II	Connector, WM4C	1	8000112516	
PVC DC 2I 10 10MPP SPD1R EVO 11	10 MPPT	2 Inputs	1 Output	Type: I / II	Connector, MC4-Evo 2	1	8000106274	
PVC DC 2I 20 10MPP SPD1R EVO 11	10 MPPT	2 Inputs	2 Outputs	Type: I / II	Connector, MC4-Evo 2	1	8000107559	
PVC DC 2I 10 12MPP SPD1R WM4 11	12 MPPT	2 Inputs	2 Outputs	Type: I / II	Connector, WM4C	1	8000115469	
PVC DC 2I 10 12MPP SPD1R EVO 11	12 MPPT	2 Inputs	2 Outputs	Type: I / II	Connector, MC4-Evo 2	1	8000107558	
<b>No fuse holder, with switch-disconnector</b>								
PVN DC 3I 30 2MPP SW SPD1R WM4 11	2 MPPT	3 Inputs	3 Outputs	Type: I / II	Connector, WM4C	1	2890480000	
PVN DC 3I 30 2MPP SW SPD1R CG 11	2 MPPT	3 Inputs	3 Outputs	Type: I / II	Cable gland, PUSH-IN connection	1	2890600000	
PVN DC 3I 30 2MPP SW SPD1R EVO 11	2 MPPT	3 Inputs	3 Outputs	Type: I / II	Connector, MC4-Evo 2	1	2890360000	
PVN DC 3I 30 3MPP SW SPD1R WM4 11	3 MPPT	3 Inputs	3 Outputs	Type: I / II	Connector, WM4C	1	2890490000	
PVN DC 3I 30 3MPP SW SPD1R CG 11	3 MPPT	3 Inputs	3 Outputs	Type: I / II	Cable gland, PUSH-IN connection	1	2890610000	
PVN DC 3I 30 3MPP SW SPD1R EVO 11	3 MPPT	3 Inputs	3 Outputs	Type: I / II	Connector, MC4-Evo 2	1	2890370000	
<b>With fuse holder, no switch-disconnector</b>								
PVN DC 3IF 30 2MPP SPD1R WM4 10	2 MPPT	3 Inputs	3 Outputs	Type: I / II	Connector, WM4C	1	2683080000	
PVN DC 3IF 30 2MPP SPD1R CG 10	2 MPPT	3 Inputs	3 Outputs	Type: I / II	Cable gland, PUSH-IN connection	1	2683040000	
PVN DC 3IF 30 2MPP SPD1R EVO 10	2 MPPT	3 Inputs	3 Outputs	Type: I / II	Connector, MC4-Evo 2	1	2925840000	
PVN1M1I6SXF3V101TXPX10	1 MPPT	6 Inputs	6 Outputs	Type: I / II	Connector, WM4C	1	2737440000	
PVN1M1I6SXF3V100TXPX10	1 MPPT	6 Inputs	6 Outputs	Type: I / II	Cable gland, PUSH-IN connection	1	2737520000	
<b>With fuse holder, with switch-disconnector</b>								
PVN DC 3IF 30 2MPP SW SPD1R WM4 10	2 MPPT	3 Inputs	3 Outputs	Type: I / II	Connector, WM4C	1	2683100000	
PVN DC 3IF 30 2MPP SW SPD1R CG 10	2 MPPT	3 Inputs	3 Outputs	Type: I / II	Cable gland, PUSH-IN connection	1	2683060000	
PVN DC 3IF 30 2MPP SW SPD1R EVO 10	2 MPPT	3 Inputs	3 Outputs	Type: I / II	Connector, MC4-Evo 2	1	2925860000	
PVN1M1I6SOF3V101TXPX10	1 MPPT	6 Inputs	6 Outputs	Type: I / II	Connector, WM4C	1	2737480000	
PVN1M1I6SOF3V100TXPX10	1 MPPT	6 Inputs	6 Outputs	Type: I / II	Cable gland, PUSH-IN connection	1	2737530000	
<b>Monitoring</b>								
<b>With fuse holder, with switch-disconnector for Fronius Tauro Eco</b>								
PV 210SOF3CXV100TXPX10PWV	1 MPPT	10 Inputs	1 Output	Type: I / II	Cable gland, Gland connection	Without	1	8000111135
PV 210SOF3CXV100TA1PA10PWV	1 MPPT	10 Inputs	1 Output	Type: I / II	Cable gland, Gland connection	With	1	8000111136
PV 210S5F3CXV100TXPX10PWV	2 MPPT	10 Inputs	1 Output	Type: I / II	Cable gland, Gland connection	Without	1	8000111137
PV 210S5F3CXV100TA1PA10PWV	2 MPPT	10 Inputs	1 Output	Type: I / II	Cable gland, Gland connection	With	1	8000111138





## PV Next combiner boxes for PV systems in residential buildings

Type	MPP	Inputs per MPP	Outputs per MPP	Surge protection requirement class	Connection	Qty.	Order No.
<b>No fuse holder, no switch-disconnector</b>							
PVN DC 2I 10 1MPP SPD1R WM4 11	1 MPPT	2 Inputs	1 Output	Typw: I / II	Connector, WM4C	1	2791920000
PVN DC 2I 10 1MPP SPD1R CG 11	1 MPPT	2 Inputs	1 Output	Type: I / II	Cable gland, PUSH-IN connection	1	2791930000
PVN DC 2I 10 1MPP SPD1R EVO 11	1 MPPT	2 Inputs	1 Output	Type: I / II	Connector, MC4-Evo 2	1	2866300000
PVN DC 2I 10 1MPP SPD2R WM4 11	1 MPPT	2 Inputs	1 Output	Type: II	Connector, WM4C	1	2791940000
PVN DC 2I 10 1MPP SPD2R CG 11	1 MPPT	2 Inputs	1 Output	Type: II	Cable gland, PUSH-IN connection	1	2791950000
PVN DC 2I 10 1MPP SPD2R EVO 11	1 MPPT	2 Inputs	1 Output	Type: II	Connector, MC4-Evo 2	1	2866310000
PVN DC 3I 30 1MPP SPD1R WM4 11	1 MPPT	3 Inputs	3 Outputs	Type: I / II	Connector, WM4C	1	2890440000
PVN DC 3I 30 1MPP SPD1R CG 11	1 MPPT	3 Inputs	3 Outputs	Type: I / II	Cable gland, PUSH-IN connection	1	2890560000
PVN DC 3I 30 1MPP SPD1R EVO 11	1 MPPT	3 Inputs	3 Outputs	Type: I / II	Connector, MC4-Evo 2	1	2890320000
PVN DC 2I 10 2MPP SPD1R WM4 11	2 MPPT	2 Inputs	1 Output	Type: I / II	Connector, WM4C	1	2866340000
PVN DC 2I 10 2MPP SPD1R CG 11	2 MPPT	2 Inputs	1 Output	Type: I / II	Cable gland, PUSH-IN connection	1	2866320000
PVN DC 2I 10 2MPP SPD1R EVO 11	2 MPPT	2 Inputs	1 Output	Type: I / II	Connector, MC4-Evo 2	1	2866360000
PVN DC 2I 10 2MPP SPD2R WM4 11	2 MPPT	2 Inputs	1 Output	Type: II	Connector, WM4C	1	2866350000
PVN DC 2I 10 2MPP SPD2R CG 11	2 MPPT	2 Inputs	1 Output	Type: II	Cable gland, PUSH-IN connection	1	2866330000
PVN DC 2I 10 2MPP SPD2R EVO 11	2 MPPT	2 Inputs	1 Output	Type: II	Connector, MC4-Evo 2	1	2866370000
PVN DC 3I 30 2MPP SPD1R WM4 11	2 MPPT	3 Inputs	3 Outputs	Type: I / II	Connector, WM4C	1	2890450000
PVN DC 3I 30 2MPP SPD1R CG 11	2 MPPT	3 Inputs	3 Outputs	Type: I / II	Cable gland, PUSH-IN connection	1	2890570000
PVN DC 3I 30 2MPP SPD1R EVO 11	2 MPPT	3 Inputs	3 Outputs	Type: I / II	Connector, MC4-Evo 2	1	2890330000
PVN DC 2I 10 3MPP SPD1R WM4 11	3 MPPT	2 Inputs	1 Output	Type: I / II	Connector, WM4C	1	2975520000
PVN DC 2I 20 3MPP SPD1R CG 11	3 MPPT	2 Inputs	1 Output	Type: I / II	Cable gland, PUSH-IN connection	1	2975540000
PVN DC 2I 10 3MPP SPD1R EVO 11	3 MPPT	2 Inputs	1 Output	Type: I / II	Connector, MC4-Evo 2	1	2975530000
PVN DC 2I 10 3MPP SPD2R WM4 11	3 MPPT	2 Inputs	1 Output	Type: II	Connector, WM4C	1	2975550000
PVN DC 2I 10 3MPP SPD2R CG 11	3 MPPT	2 Inputs	1 Output	Type: II	Cable gland, PUSH-IN connection	1	2975570000
PVN DC 2I 10 3MPP SPD2R EVO 11	3 MPPT	2 Inputs	1 Output	Type: II	Connector, MC4-Evo 2	1	2975560000
<b>No fuse holder, with switch-disconnector</b>							
PVN DC 3I 30 1MPP SW SPD1R WM4 11	1 MPPT	3 Inputs	3 Outputs	Type: I / II	Connector, WM4C	1	2890470000
PVN DC 3I 30 1MPP SW SPD1R CG 11	1 MPPT	3 Inputs	3 Outputs	Type: I / II	Cable gland, PUSH-IN connection	1	2890590000
PVN DC 3I 30 1MPP SW SPD1R EVO 11	1 MPPT	3 Inputs	3 Outputs	Type: I / II	Connector, MC4-Evo 2	1	2890350000
<b>With fuse holder, no switch-disconnector</b>							
PVN DC 3IF 30 1MPP SPD1R CG 10	1 MPPT	3 Inputs	3 Outputs	Type: I / II	Cable gland, PUSH-IN connection	1	2683030000
PVN DC 3IF 30 1MPP SPD1R WM4 10	1 MPPT	3 Inputs	3 Outputs	Type: I / II	Connector, WM4C	1	2683070000
PVN DC 3IF 30 1MPP SPD1R EVO 10	1 MPPT	3 Inputs	3 Outputs	Type: I / II	Connector, MC4-Evo 2	1	2925830000
<b>With fuse holder, with switch-disconnector</b>							
PVN DC 3IF 30 1MPP SW SPD1R CG 10	1 MPPT	3 Inputs	3 Outputs	Type: I / II	Cable gland, PUSH-IN connection	1	2683050000
PVN DC 3IF 30 1MPP SW SPD1R WM4 10	1 MPPT	3 Inputs	3 Outputs	Type: I / II	Connector, WM4C	1	2683090000
PVN DC 3IF 30 1MPP SW SPD1R EVO 10	1 MPPT	3 Inputs	3 Outputs	Type: I / II	Connector, MC4-Evo 2	1	2925850000



### i

#### More designs on request

Our portfolio protects a variety of string inverters available on the market. However, new variants come on the market regularly and sometimes you need a very special design for your application. Therefore, we have set up an efficient process that allows us to always offer the right solution in the usual quality.

Just send us your use case and requirements. We will create a custom-fit design and offer for you.



Click here to get to the contact form:  
[www.weidmueller.com/contact-pv](http://www.weidmueller.com/contact-pv)

# PV Next Fireman Switch

## Switch off systems in case of fire

B



Building insurers and local fire brigades are increasingly demanding that rooftop photovoltaic systems switch off automatically in the event of a fire. This switch-off device must be placed when the string cables enter the building. Automatic switch-off occurs when the fire brigade switches off the building's power supply. This allows the fire brigade to carry out extinguishing work in an emergency without being unnecessarily endangered. When the power supply is restored, the PV Next Fireman Switch automatically reconnects the PV strings.

The PV Next Fireman Switch is also available in combination with overvoltage protection on the DC side.



For more information, visit our website:  
[www.weidmuller.com/pvnextfireman](http://www.weidmuller.com/pvnextfireman)



**2** PV Next fireman switch switches off the current flow automatically

**1** Fire brigade disconnects AC power supply



Watch our video to find out more about how the PV Next fireman switch works.

Recommended protection for commercial buildings



## Your special advantages

- Fully automatic switch-on and switch-off
- Efficient combination of strings with cable savings of up to 50 %
- Simple and space-saving installation
- Short-term energy consumption only when switching on and off
- Standard variants available from stock
- Automatic shutdown at temperatures over 100 °C
- Two functions, one compact design: variants with integrated surge protection

### Possible installation scheme\*

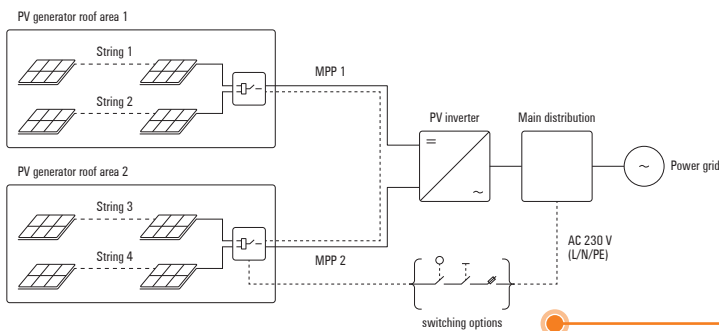

### Accessories

Type	Order No.
AC SB E 5A 1POL PO 06KV	3077660000



\*For further installation examples and questions about standard-compliant installation, please contact us: [www.weidmueller.com/contact-pv](http://www.weidmueller.com/contact-pv)

### PV Next Fireman Switch

Type	MPP	Inputs per MPP	Outputs per MPP	Current per box	Connection	Qty.	Order No.
PVN DC 2I 10 1MPP RD CG 11	1 MPP	2 inputs	1 output	50A	Cable gland, PUSH IN connection	1	2778850000
PVN DC 2I 10 1MPP RD WM4 11	1 MPP	2 inputs	1 output	34A	Connector, WM4C	1	2778860000
PVN DC 2I 10 1MPP RD EVO 11	1 MPP	2 inputs	1 output	34A	Connector, MC4-Evo 2	1	2888520000
PVN DC 2I 10 2MPP RD CG 11	2 MPP	2 inputs	1 output	2x 50A	Cable gland, PUSH IN connection	1	2778870000
PVN DC 2I 10 2MPP RD WM4 11	2 MPP	2 inputs	1 output	2x 34A	Connector, WM4C	1	2778880000
PVN DC 2I 10 2MPP RD EVO 11	2 MPP	2 inputs	1 output	2x 34A	Connector, MC4-Evo 2	1	2888530000
PVC DC 2I 10 4MPP RD WM4 11	4 MPP	2 inputs	1 output	4x 34A	Connector, WM4C	1	8000115472
PVC DC 2I 10 4MPP RD EVO 11	4 MPP	2 inputs	1 output	4x 34A	Connector, MC4-Evo 2	1	800011429
PVC DC 2I 10 6MPP RD WM4 11	6 MPP	2 inputs	1 output	6x 34A	Connector, WM4C	1	8000115473
PVC DC 2I 10 6MPP RD EVO 11	6 MPP	2 inputs	1 output	6x 34A	Connector, MC4-Evo 2	1	800011430
PVC DC 2I 20 10MPP RD EVO 11	10 MPPT	2 inputs	2 output	10x 35A	Connector, MC4-Evo 2	1	8000130051
PVC DC 2I 20 10MPP RD WM4 11	10 MPPT	2 inputs	2 output	10x 35A	Connector, WM4C	1	8000130052
PVC DC 2I 20 12MPP RD EVO 11	12 MPPT	2 inputs	2 output	12x 35A	Connector, MC4-Evo 2	1	8000130054
PVC DC 2I 20 12MPP RD WM4 11	12 MPPT	2 inputs	2 output	12x 35A	Connector, WM4C	1	8000130055

1100V DC  
230V AC



### PV Next Fireman Switch with SPD

Type	MPP	Inputs per MPP	Outputs per MPP	Surge protection requirement class	Connection	Qty.	Order No.
PVC DC 2I 10 2MPP RD SPD1R WM4 11	2 MPP	2 inputs	1 output	Type: I / II	Connector, WM4C	1	8000114374
PVC DC 2I 10 2MPP RD SPD1R EVO 11	2 MPP	2 inputs	1 output	Type: I / II	Connector, MC4-Evo 2	1	8000098970
PVC DC 2I 10 4MPP RD SPD1R WM4 11	4 MPP	2 inputs	1 output	Type: I / II	Connector, WM4C	1	8000115470
PVC DC 2I 10 4MPP RD SPD1R EVO 11	4 MPP	2 inputs	1 output	Type: I / II	Connector, MC4-Evo 2	1	8000110665
PVC DC 2I 10 6MPP RD SPD1R WM4 11	6 MPP	2 inputs	1 output	Type: I / II	Connector, WM4C	1	8000115471
PVC DC 2I 10 6MPP RD SPD1R EVO 11	6 MPP	2 inputs	1 output	Type: I / II	Connector, MC4-Evo 2	1	8000112724
PVC DC 2I 20 10MPP SPD 1R EVO 11	10 MPPT	2 inputs	2 outputs	Type: I / II	Connector, MC4-Evo 2	1	8000130058
PVC DC 2I 20 10MPP SPD 1R WM4 11	10 MPPT	2 inputs	2 outputs	Type: I / II	Connector, WM4C	1	8000130053
PVC DC 2I 20 12MPP SPD 1R EVO 11	12 MPPT	2 inputs	2 outputs	Type: I / II	Connector, MC4-Evo 2	1	8000130056
PVC DC 2I 20 12MPP SPD 1R WM4 11	12 MPPT	2 inputs	2 outputs	Type: I / II	Connector, WM4C	1	8000130057



## PV Inline

### PV surge protection for small installation environments

B

#### Compact combiner box for installation on a wall, cable duct or PV modules

The compact PV combiner box PV Inline finds use in PV rooftop installations. It protects the PV system from overvoltages, including lightning strikes. In the event of an overvoltage, it creates a ground connection. The space-saving SPD is particularly suitable for confined spaces. It can be integrated into cable channels or mounted behind PV modules.



More information on our website:  
[www.weidmueller.com/pvinline](http://www.weidmueller.com/pvinline)

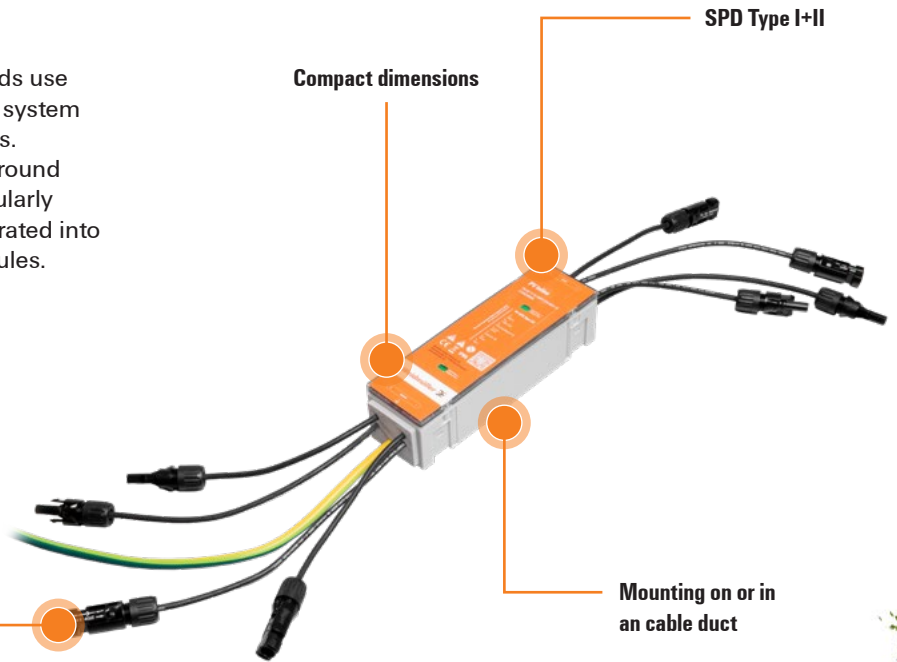

Original Stäubli MC4-Connector

#### Your benefits:

- Most compact dimension on the market
- Optical integration in or on a standard cable duct (60-40mm)
- Universal mounting feet for mounting on wall or cable duct included
- Mounting behind the PV panel for large systems with more than 10m cable length
- Plug & Play: PV Inline does not need to be opened for wiring

## PV Inline – simple installation with many options

PV Inline does not require the housing to be opened, which speeds up wiring. For mounting on the wall or on a cable duct, two brackets are included, into which the PV combiner box can be hooked into. With only quarter size of comparable products, PV Inline is easy to hold with one hand during installation.



### Mounting on cable channels

PV Inline can be easily mounted on a standard 60 x 40 mm cable duct using special mounting aids, so the compact PV combiner box becomes visually part of the channel.

Suitable cable channel systems:  
Hager TEHALIT LF4006009016 and  
LF4006007035, Würth PLF 4060



### Mounting on the wall

Whether between two cable channels or where cables enter the house in the attic: Simply attach the mounting feet to the wall and snap PV Inline into place.



### Mounting behind PV modules

Due to its compact dimensions, PV Inline can also be attached to the mounting structure of the PV system. This is also advantageous for large systems with a distance of more than 10 metres between the inverter and PV modules.

B



## Earth connection

The earth connection can be quickly realised using the space-saving potential distribution terminal with 3 screw connections.

### PV Inline

MPP	Surge protection	Inputs per MPP	Outputs per MPP	Max. current	Connection	Order No.
1 MPP	Type I+II	1 Input	1 Output	1x39 A	Stäubli MC4	3108220000
2 MPP	Type I+II	1 Input	1 Output	2x39 A	Stäubli MC4	3108230000



### Earth connection Potential distribution terminal for cable duct

Conductor cross-sections	Screw connections	Order No.
6 to 50mm <sup>2</sup>	3	1547490000



# AC Installation Boxes

## Protect charging stations and PV systems against overvoltage

B



Protect your string inverter or your wallbox from overvoltages on the AC side of your installation. Especially for cable lengths over 10 metres, a compact and flexible solution is required by standards.

Weidmüller offers a quick and easy to install solution to protect the system components. In addition to protection against overvoltages on the AC side, data lines are also protected against harmful voltages.



For more information, visit our website:  
[www.weidmueller.com/ac-spd-box](http://www.weidmueller.com/ac-spd-box)



The AC SPD-Box protects the AC side of the inverter against overvoltages

The AC SPD-Box protects the wallbox against overvoltages



## Ready-to-install AC surge protection

The AC SPD box is a ready-to-install solution to reliably protect both charging stations from 11-22kW and PV systems against surges. The solution is equipped with Type II AC surge protection and additional surge protection for data cables (RJ45 connection). The compact design with IP65 and a temperature range of -25 to 50 °C is very suitable for outdoor use.

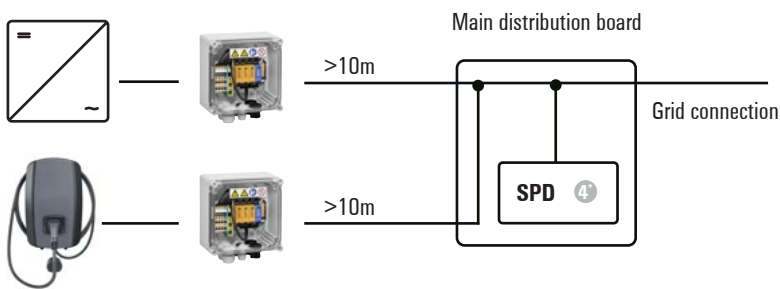

### Your advantages

- Quick installation thanks to Push-In technology
- Use for both charging stations and PV systems
- Protection of the data lines against overvoltages

\*see selection table on page 6

### AC SPD-Box

Type	Inputs	Outputs	Max. cable diameter	Overvoltage protection	Connection	Order No.
PVC AC 11 10 SPD2R + RJ45 04	1	1	6mm <sup>2</sup>	Type II	Cable glands	<b>8000104168</b>



# FAQs – Frequently Asked Questions about the Installation

## B

### What are the special features of PV Next combiner boxes and how do I find the right variant?

For a PV system on the roof, a GAK approved in accordance with IEC 61439-2 is required to protect the system against overvoltage. The GAK PV Next also offers additional functions, such as the bundling of strings for reduced cabling effort. Depending on the inverter of your PV system, a suitable variant of the GAK is required. You can easily find the right variant using the selection guide on our website.

### How do you protect PV installations against lightning strikes?

The overvoltage protection inside a PV combiner box (DC side of the installation) is one part of the lightning protection system (LPS) of a building and is mandatory according to EN 51643-32 in the EU and beyond since 2019. It is used to protect your PV system and the electronic inside the house against overvoltages.

### When are DC fuses mandatory to install?

Depending on the kind of photovoltaic installation, a combiner box with fuses is required. According to the IEC 62548:2016, fuses are mandatory if the maximum return current is higher than the return current of the module.



All technical details, our fact sheets and other frequently asked questions can be found on our website: [www.weidmueller.com/pv-FAQ](http://www.weidmueller.com/pv-FAQ)

## More tips for an easy PV installation:

### Selection guide – PV Combiner Box:

#### Select inverter

Manufacturer

Inverter type



Output of matching combiner box



Scan now and find your matching combiner box: [www.weidmueller.com/pvselector](http://www.weidmueller.com/pvselector)

### YouTube-Playlist:



Take a look at our YouTube Playlist Photovoltaics to find out more

# Efficient operation of PV farms

## Discover our solutions for utility scale PV systems

The biggest challenges of our time include climate protection and the energy transition. Utility scale PV systems are a step in the right direction here. That's why we at Weidmüller want to support you in expanding photovoltaic energy.

Our product programme offers reliable connection technology, protects your systems and enables plant monitoring. This reduces manual efforts for monitoring, maintenance and servicing. With our innovative product range, you can operate your photovoltaics parks more efficiently and without downtimes. From distribution boxes to monitoring solutions and components – our products and solutions meet the highest requirements. We combine our extensive range of components with decentralisation and Industrial IoT solutions.

B



For further information, technical specifications or additional services, please visit our website:  
[www.weidmueller.com/pv-utility](http://www.weidmueller.com/pv-utility)



# PV DC Combiner Boxes

## Central Inverter Concept

### Bundle, protect and combine PV strings efficiently

B

Our DC combiner boxes offer users the possibility to integrate short-circuit and overvoltage protection, as well string monitoring solutions (I, V, T and SPD and switch isolator status), for PV systems using central inverters with PV panels in trackers and fix tilt systems.

Weidmüller offers a trackrecord of DC combiner boxes higher than 250.000 units sold in all climate regions of the planet for more than 15 years. The experience and expertise in the DC engineering is used to provide high-end solutions covering the CAPEX and OPEX needs of the customer. Models equipped with string monitoring provide additional performance with voltage, current and temperature measurement as well as SPD health and DC switch status. This helps to improve PR of plants and optimises the ROI.



- DC cable
- - - RS-485 communicatons
- MV line
- Communications line
- ⊞ Wireless communications

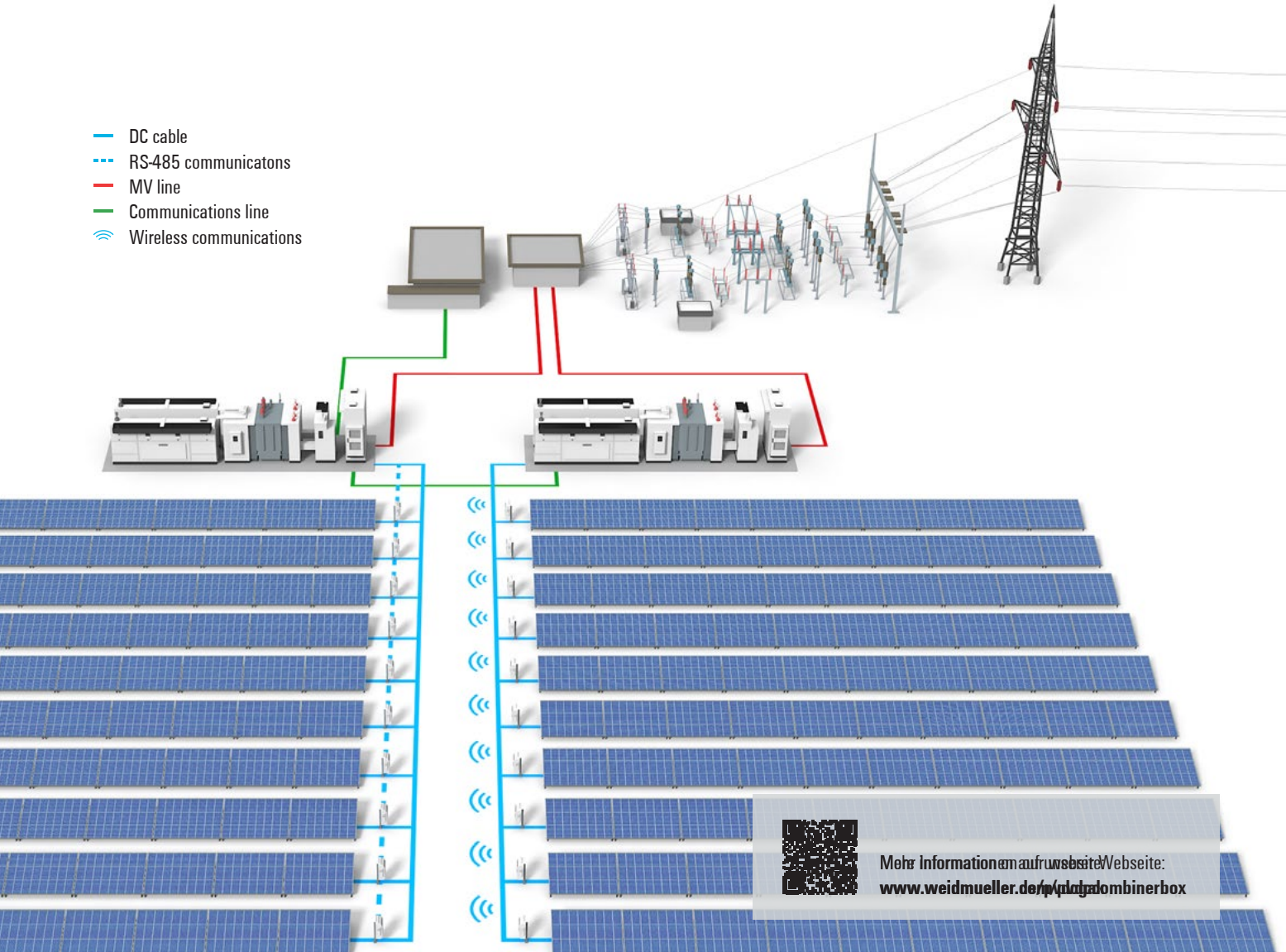

Mehr Informationen auf unserer Website:  
[www.weidmueller.de/produkte/combinerbox](http://www.weidmueller.de/produkte/combinerbox)



## Key features & benefits

- **Optimised design** – By using advanced simulation 3D softwares, the product variants have been designed and tested to operate at the maximum mechanical and thermal efficiency in the most compact housing size.
- **All technical data available online with 1-click** – Weidmüller offers web tools to support on the selection of the best model for your application. Technical data and certifications are available in the Weidmüller online catalogue.
- **Cost-optimised variants** – With the new product line cost optimised models with special accessories were designed which cover the most common applications in PV power plants.
- **Longer lifetime** – DC engineering expertise implemented in designs to allow longer lifetime and higher performance under extreme climatic conditions.
- **Better LCOE and ROI** – Product trackrecord, bankability and reputation of our solutions simplify product due diligences, insurance contracts and even to increase value of the asset in case it is sold in the future.

## Technical data: PV DC Combiner Boxes

<b>Main application features</b>	
Inputs	from 8 to 32
Outputs	1-2
Operating ambient temperature	-20°C up to 50°C
DC earthing system	Floating, negative grounded or positive grounded
Installation location	Protected outdoors
Altitude above the sea level	up to 2000m (standard) higher altitude on demand
<b>Main electrical features</b>	
Rated DC voltage	from 1000 V DC up to 1500 V DC
Rated DC current per input	up to 48 A
Maximum fuse size	up 35 A for 10x85 mm up 75 A for 22x58 mm
Protection against overcurrent	gPV fuses according to IEC 60269-6
Fuses	On both poles or on one pole
Switch disconnecter	Yes
Switch disconnecter rating	up to 500 A (other options on demand)
<b>Enclosure</b>	
Enclosure material	GFRP (Glass Fiber Reinforced Polyester)
Enclosure shape	Portrait or Landscape
Enclosure fixing system	Wall mounted, pedestal or piling fixation
Degree of protection	IP65
Form factor	Cabinet with hinged door
Polycarbonate protection plate	Yes (optional)
<b>Surge protections</b>	
Surge protection device	Type I+II or Type II
Auxiliary contacts	Yes (optional)
Surge protection on RS-485 ports	Yes (optional)
<b>String monitoring</b>	
String monitoring device	Yes (optional)
Main monitored parameters	Voltage, current, temperature, SPD status, switch isolator status and auxiliary alarms
Voltage measurement	from 200 V DC up to 1500 V DC
Current measurement	up to 50 A per string/input
Communication port	RS-485 or wireless (LoRAWAN)
Protocol	Modbus/RTU
Power supply for string monitoring device	DC/DC converter (self powered string monitoring)
<b>Others</b>	
Input connectors	WM4 C PV connectors or cable glands (other options on demand)
<b>Standards</b>	
Standards	IEC 61439-2 ED 3 / EN61439-2:2021

# PV Floating DC Combiner Boxes

## Floating Solar Installations

### Collect, protect and monitor DC strings in extreme environments

B

The lack of land requires the development of new locations for PV systems. In this case, water surfaces are particularly suitable because of the low shading and the cooling effect of the water. However, the ambient conditions place high demands on the generator connection boxes.

Our PV DC Floating Combiner Boxes are designed for use in floating PV systems on freshwater surfaces and equipped with central inverters. They comply with IEC-61439 (ed. 2) and withstand high humidity, corrosive atmosphere and exposure to sunlight. We offer a wide range of plug & play variants from 8 to 24 inputs - with comprehensive protection and suitable covering solutions and DC switch status. This helps to improve PR of plants and optimises the ROI.



### Key features & benefits

- **Absorbing aluminum alloy sunshade** – The specially developed aluminum 5457 (with magnesium) sunshade absorbs incident solar radiation and heat. Its surface finishing increases the reflection index and efficiently deflects the incident radiation. This reduces the temperature inside the combiner box very effectively.
- **Reliable sealing function** – The aluminum cover is fixed to the enclosure door with stainless steel blind rivets. The rivets are located outside the area of the door seal, so that the sealing function according to IP65 is reliably guaranteed at all times.
- **Ensured ventilation** – An air gap between the door housing and the aluminum alloy cover ensures constant air convection. In this way, the combiner box and its components are reliably cooled.
- **Optimum watertightness** – Multivita cable glands ensure optimum watertightness. They reduce the number of mechanical parts and make the entire construction more robust.



More information on our website:  
[www.weidmueller.com/pvfloating](http://www.weidmueller.com/pvfloating)



#### Ensured quality

Watch our video and see how our PV Floating DC Combiner Boxes are manufactured.





## Easy connection - low maintenance

Due to the pre-assembled Aluminium cover, our combiner boxes do not require any additional preparation work during installation. The innovative PV connection makes the entire solution plug-and-play. Our combiner boxes are made of GFRP and therefore do not need to be repainted regularly. A decisive advantage over metal housings.



### Suitable for high humidity

PV-DC floating combiner boxes are specially designed for Severity Class B environments according to IEC 61439 (ed. 2). Therefore, they are suitable for operation in extremely humid and corrosive environments.



### Suitable for direct sunlight

PV-DC floating combiner boxes can be operated in direct sunlight without the need to install an additional sunshield. The pre-mounted aluminum cover improves the performance of the system.



### Suitable for PV systems in freshwater

The PV DC Floating Combiner Boxes can be operated in floating PV systems on freshwater surfaces. They have been extensively tested and are certified for long-term operation under these specific environmental conditions.

# PV DC Combiner Boxes for High Power Panels

## Central Inverter Concept & High voltages

### Compact and durable solutions for bifacial half-cell modules

B

Bifacial solar panels have solar cells on both the front and the back of the panel. This allows the solar energy to be collected on the back of the panel and increases the energy yield of the solar energy system. Our four new PV-DC combination boxes for bifacial half-cell modules allow a higher current consumption due to the fuse holders used.

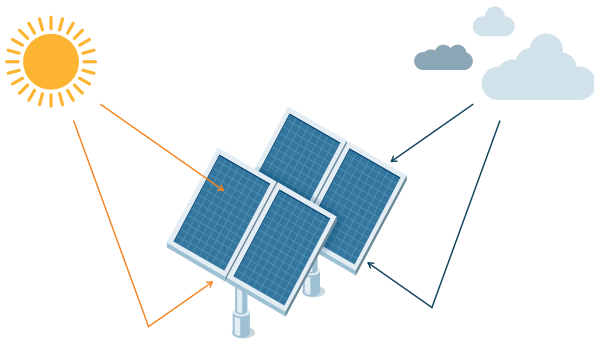

### Space optimized and higher reliability

Increasing the power of PV panels (mono and bifacial) with half-cut cells leads to a rise of current in the strings. The need for higher rated fuses is then mandatory and requires a new approach to system design. Our new designs of PV DC high current combiner boxes offer easy adaptation and time saving for new developments.

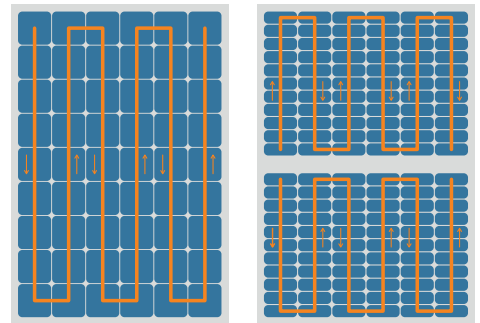

### Key features & benefits

- **Standard options in stock ready to order** – A wide range of solutions, available for immediate order from stock to fit into the installation concepts with the brands of PV modules presented above. Variants: With 6 and 8 inputs, with fuse protection in (+/-) poles and with gPV fuses from of 22x58 mm format and a rated current per fuse between 35 A up to 75 A.
- **Overvoltage protections** – With several configurations, Weidmüller offers the VPU surge protection series for 1500 V DC systems with up to 11 kA I<sub>sc</sub> and Type I+II or Type II variants.
- **Optimised design** – Through the use of advanced 3D simulation software, the product variants have been designed and tested to operate with maximum mechanical and thermal efficiency in the most compact enclosure possible.
- **Special Fuse protection** – Weidmüller fuses (WSFL) and fuse holders (WSFH) have been specially developed for this new architecture. Rated currents of 35 to 75 A per input enable the connection of single and double strings.



## Ordering data for DC Combiner Boxes

### PV DC Combiner Boxes

Type	Inputs	Fuse Protection	Max Fuse Rate	Max Isc	Fuse Included	String Monitoring	Type of enclosure	Enclosure Size	Max Oper. Temp	Order No.
PV 212SOF3CXXV000TXPX15PWW	12	Both Poles	30 A	17 A	No	No	Portrait	747 x 536 x 300 mm	45°C	8000112693
PV 212SOF3CXXV000TA1PA15PWW	12	Both Poles	30 A	17 A	No	Yes	Portrait	847 x 636 x 300 mm	45°C	8000115422
PV 214SOF3CXXV000TXPX15PWW	14	Both Poles	32 A	20 A	No	No	Portrait	847 x 636 x 300 mm	45°C	8000124304
PV 216SOF4CXXV000TXPX15LWW	16	One Pole	25 A	16 A	No	No	Landscape	536 x 747 x 300 mm	40°C	8000078885
PV 216SOF3CXXV000TXPX15PWW (*)	16	Both Poles	32 A	19.5 A	No	No	Portrait	835 x 635 x 300 mm	45°C	8000124309
PV 216SOF3CXXV000TXPX15LWW	16	Both Poles	30 A	18 A	No	No	Landscape	636 x 847 x 300 mm	45°C	8000119547
PV 216SOF3CXXV000TAPX15LWW (*)	16	Both Poles	25 A	14 A	No	Yes	Landscape	636 x 847 x 300 mm	45°C	8000093503
PV 216SOF3CXXV000TXPX15PWW	16	Both Poles	25 A	14 A	No	No	Portrait	747 x 536 x 300 mm	45°C	8000078118
PV 218SOF3CXXV000TXPX15PWW	18	Both Poles	30 A	18 A	No	No	Portrait	835 x 635 x 300 mm	45°C	8000124306
PV 220SOF4CXXV000TXPX15PWW	20	One Pole	25 A	14 A	No	No	Portrait	747 x 536 x 300 mm	45°C	8000078883
PV 220SOF4CXXV000TAPX15PWW	20	One Pole	30 A	18 A	No	Yes	Portrait	835 x 635 x 300 mm	45°C	8000093501
PV 220SOF3CXXV000TXPX15LWW	20	Both Poles	30 A	17 A	No	No	Landscape	636 x 847 x 300 mm	45°C	8000119548
PV 220SOF3CXXV000TXPX15PWW (*)	20	Both Poles	30 A	17 A	No	No	Portrait	835 x 635 x 300 mm	45°C	8000124332
PV 224SOF3CXXV000TA1PA15LWW (*)	20	Both Poles	25 A	15 A	No	Yes	Landscape	636 x 847 x 300 mm	45°C	8000119550
PV 224SOF3CXXV000TXPX15LWW	24	Both Poles	25 A	14 A	No	No	Landscape	636 x 847 x 300 mm	45°C	8000078884
PV 224SOF3CXXV000TXPX15PWW (*)	24	Both Poles	25 A	14 A	No	No	Portrait	847 x 636 x 300 mm	45°C	8000078882
PV 224SOF3CXXV000TAPX15PWW	24	Both Poles	25 A	13 A	No	Yes	Portrait	847 x 636 x 300 mm	45°C	8000093500
PV 224SOF3CXXV000TAPX15LWW (*)	24	Both Poles	25 A	14 A	No	Yes	Landscape	636 x 847 x 300 mm	45°C	8000093502
PV 224SOF4CXXV000TXPX15PWW	24	One Pole	25 A	14 A	No	No	Portrait	847 x 636 x 300 mm	45°C	8000068263
PV 224SOF3CXXV000TXPX15PWW	24	Both Poles	30 A	17.5 A	No	No	Portrait	1056 x 852 x 350 mm	45°C	8000124311
PV 224SOF3CXXV000TA1PA15PWW	24	Both Poles	30 A	17.5 A	No	Yes	Portrait	1056 x 852 x 350 mm	45°C	8000124310
PV 232SOF4CXXV003TXPX15PWW	32	One Pole	20 A	10 A	No	No	Portrait	847 x 636 x 300 mm	50°C	8000060710

### PV Floating DC Combiner Boxes

Type	Inputs	Fuse protection	Rated voltage	String monitoring	Type of enclosure	Enclosure size	Qty.	Order No.
PV 216SOF3CXXV003T7P015PFJP	16	Both Poles	1500 V DC	Integrated Monitoring System	Portrait	847 x 636 x 300 mm	1	8000057079
PV 216SOF3CXXV003TXPX15PFJP	16	Both Poles	1500 V DC	No	Portrait	847 x 636 x 300 mm	1	8000057080
PV 218SOF0C15V003TXPX15PFWW	18	Both Poles	1500 V DC	No	Portrait	847 x 636 x 300 mm	1	8000057083
PV 220SOF3CXXV003TXPX15PFJP	20	Both Poles	1500 V DC	No	Portrait	847 x 636 x 300 mm	1	8000057081
PV 224SOF1C15V003TXPX15PFWW	24	One Pole	1500 V DC	No	Portrait	847 x 636 x 300 mm	1	8000057088
PV 224SOF1C15V003T7P015PFWW	24	One Pole	1500 V DC	Integrated Monitoring System	Portrait	847 x 636 x 300 mm	1	8000057085
PV 224SOF3CXXV003TXPX15PFJP	24	Both Poles	1500 V DC	No	Portrait	847 x 636 x 300 mm	1	8000057077

### PV DC Combiner Boxes for High Power Panels

Type	Inputs	Rated voltage	Max Isc per input	String monitoring	Enclosure size	Qty.	Order No.
PV 206SOF3CXXV000TXPX15LWW	6	1500 V DC	22 A	No	636 x 847 x 300 mm	1	8000081269
PV 208SOF3CXXV000TXPX15LWW	8	1500 V DC	21 A	No	747 x 536 x 300 mm	1	8000081271
PV 208SOF3CXXV000TXPX15LWW	8	1500 V DC	32 A	No	636 x 847 x 300 mm	1	8000081272
PV 206SOF3CXXV000TAPA15LWW	6	1500 V DC	25 A	Integrated Monitoring System	636 x 847 x 300 mm	1	8000101211
PV 208SOF3CXXV000TAPA15LWW	8	1500 V DC	25 A	Integrated Monitoring System	636 x 847 x 300 mm	1	8000101212
PV 210SOF3CXXV000TAPA15LWW	10	1500 V DC	25 A	Integrated Monitoring System	636 x 847 x 300 mm	1	8000101213
PV 212SOF3CXXV000TAPA15PWW	12	1500 V DC	25 A	Integrated Monitoring System	1056 x 852 x 350 mm	1	8000101214
PV 210SOF3CXXV000TAPA15PWW	10	1500 V DC	48 A	Integrated Monitoring System	1056 x 852 x 350 mm	1	8000101215

# PV DC Combiner Boxes variants for 1 MPPT inverters

## String Inverter Concepts with 1 MPPT

### Efficient and optimized solution for 1 MPPT string inverters

1 MPPT solar string inverters are being rapidly adopted as an efficient solution for large rooftop or utility scale projects. Under constant and even sunlight conditions 1 MPPT string inverters perform as efficiently as multi MPPT inverters. PV DC Combiner boxes for 1 MPPT inverters provide a compact solution to combine, protect and monitor all strings providing power to inverter DC side.

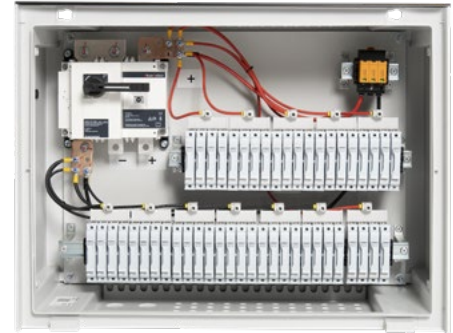

### Reduced number of MPPT's

Under the competitive landscape of the PV Solar industry new string inverter solutions have appeared. Single MPPT's string inverters provide a robust and reliable solution with reduced electronic components and complexity needed for multiple MPPT inverters. Our new PV DC Combiner boxes, allow different inverter manufacturers to introduce a complete solution with an optimized design with Weidmüller's quality standards.

#### Inverter Brands



### Key features & benefits

- **Standard options in stock ready to order** – A wide range of solutions, available for immediate order from stock to fit into the installation concepts with 1 MPPT string inverter. Variants: With from 7 to 20 inputs, with fuse
- **Solutions for 1000 V DC and 1500 V DC**
- **Overvoltage protection** – With several configurations, Weidmüller offers the VPU surge protection series for 1500 V DC systems with up to 11 kA I<sub>sc</sub> and Type I+II or Type II variants.
- **Optimized design** – Through the use of advanced 3D simulation software, the product variants have been designed and tested to operate with maximum mechanical and thermal efficiency in the most compact enclosure possible.
- **Special Fuse protection** – Weidmüller fuses (WSFL) and fuse holders (WSFH) have been specially developed for this new architecture.



## Ordering data for DC Combiner Boxes variants for 1 MPPT inverters

### PV DC Combiner Boxes for Kaco/Sungrow/Ingeteam (1500 V DC)

Type	Inputs	Fuse Protection	Max Fuse Rate	Isc	Fuse included	String monitoring	Type of enclosure	Enclosure size	Max oper. temp	Qty.	Order No.
PV 212SOF3CXXV100TXPX15LWW	12	Both Poles	30 A	19 A	No	No	Landscape	636 x 847 x 300 mm	45°C	1	8000096019
PV 212SOF3CXXV100T9P015LWW	12	Both Poles	30 A	19 A	No	Yes	Landscape	636 x 847 x 300 mm	45°C	1	8000096020
PV 215SOF3CXXV100TXPX15LWW	15	Both Poles	30 A	19 A	No	No	Landscape	636 x 847 x 300 mm	45°C	1	8000096023
PV 215SOF3CXXV100T9P015LWW	15	Both Poles	30 A	19 A	No	Yes	Landscape	636 x 847 x 300 mm	45°C	1	8000096024
PV 216SOF3CXXV100TXPX15LWW	16	Both Poles	25 A	14 A	No	No	Landscape	636 x 847 x 300 mm	45°C	1	8000096025
PV 216SOF3CXXV100T9P015LWW	16	Both Poles	25 A	14 A	No	Yes	Landscape	636 x 847 x 300 mm	45°C	1	8000096026
PV 220SOF3CXXV100TXPX15LWW	20	Both Poles	25 A	14 A	No	No	Landscape	636 x 847 x 300 mm	45°C	1	8000096027
PV 220SOF3CXXV100T9P015LWW	20	Both Poles	25 A	14 A	No	Yes	Landscape	636 x 847 x 300 mm	45°C	1	8000096028

### PV DC Combiner Boxes for Fronius (1000 V DC)

Type	Inputs	Fuse Protection	Max Fuse Rate	Isc	Fuse Included	String monitoring	Type of enclosure	Enclosure size	Max oper. temp	Qty.	Order No.
PV 207SOF3CXXV100TXPX10PDE	07	Both Poles	32 A	19 A	No	No	Portrait	747 x 536 x 300 mm	50°C	1	8000111135
PV 207SOF3CXXV100TA1PA10PDE	07	Both Poles	32 A	19 A	No	Yes	Portrait	847 x 636 x 300 mm	50°C	1	8000111136
PV 211SOF3CXXV100TXPX10PDE	11	Both Poles	32 A	19 A	No	No	Portrait	747 x 536 x 300 mm	50°C	1	8000111137
PV 211SOF3CXXV100TA1PA10PDE	11	Both Poles	32 A	19 A	No	Yes	Portrait	847 x 636 x 300 mm	50°C	1	8000111138

## Enclosure Accessories

### Enhanced protection and durability for PV Combiner Boxes

#### Secure Mounting & Environmental Protection

Fixation accessories and protective canopies are essential for photovoltaic (PV) installations, ensuring that PV DC Combiner Boxes are securely mounted and protected against dust, moisture, and harsh environmental conditions. These durable, weather-resistant components safeguard critical electrical parts, helping to reduce maintenance needs and extend the overall system lifespan. With Weidmüller's deep expertise in solar PV, these solutions are designed to optimise system efficiency while meeting strict safety and performance standards.



#### Key features & benefits

- **Secure mounting** – Fixation accessories ensure stable and reliable installation of PV DC Combiner Boxes in various site conditions.
- **Environmental protection** – Protective canopies shield against dust, rain, UV exposure, and other challenging environmental factors.
- **Extended system lifetime** – Durable materials and weather-resistant construction reduce wear on components and minimise maintenance over time.
- **Optimised efficiency** – All accessories are developed with Weidmüller's solar engineering standards to enhance overall system reliability and performance.
- **High safety standards** – Designed and tested to comply with demanding safety and operational requirements in PV applications.

## Ordering data for Enclosure Accessories

### Enclosure Accessories

Accessory Name	Type of Accessory	Material	Type of enclosure	Enclosure Brand	Enclosure Size	Order No.
PK FIXATION KIT NSYPLM108 M8	Mounting kit for pile	St-235 Zn Plated	Portrait	Schneider Electric	1056 x 852 x 350 mm	8000127909
PK FIXATION KIT NSYPLM75 M8	Mounting kit for pile	St-235 Zn Plated	Portrait	Schneider Electric	747 x 536 x 300 mm	8000127908
PK FIXATION KIT NSYPLM86 M8	Mounting kit for pile	St-235 Zn Plated	Portrait	Schneider Electric	847 x 636 x 300 mm	8000107421
PK FIXATION KIT NSYPLM810 M8	Mounting kit for pile	St-235 Zn Plated	Landscape	Schneider Electric	852 x 1056 x 350 mm	8000127907
PK FIXATION KIT NSYPLM57 M8	Mounting kit for pile	St-235 Zn Plated	Landscape	Schneider Electric	536 x 747 x 300 mm	8000127906
PK FIXATION KIT NSYPLM68 M8	Mounting kit for pile	St-235 Zn Plated	Landscape	Schneider Electric	636 x 847 x 300 mm	8000127905
SUNLIGHT COVER SCH86 ALU	Cover for floating PV DC CB	AL-5754	Portrait	Schneider Electric	847 x 636 x 300 mm	4000004848
SUNLIGHT COVER SCH108 ALU	Cover for floating PV DC CB	AL-5754	Portrait	Schneider Electric	1056 x 852 x 350 mm	4000004854
SUN CANOPY 68/108 1.5MM DX51D	Canopy for ground-mounted PV DC CB	DX51D+Z275	Both	Schneider Electric	636x847 / 1056 x 852 x 350 mm	4000009126
SUN CANOPY 57/86 1.5MM DX1D	Canopy for ground-mounted PV DC CB	DX51D+Z275	Both	Schneider Electric	536x747/ 847 x 636 x 300 mm	4000010116
SUN CANOPY 75 1.5MM DX1D	Canopy for ground-mounted PV DC CB	DX51D+Z275	Portrait	Schneider Electric	747 x 536 x 300 mm	4000010117
SUN CANOPY 810 1.5MM DX1D	Canopy for ground-mounted PV DC CB	DX51D+Z275	Landscape	Schneider Electric	1056 x 852 x 350 mm	4000010118
PK KIT PEDESTAL PEM86	Pedestal for ground-mounted PV DC CB	GFRP	Portrait	Schneider Electric	847 x 636 x 300 mm	8000036664
PK KIT PEDESTAL PEM108	Pedestal for ground-mounted PV DC CB	GFRP	Portrait	Schneider Electric	1056 x 852 x 350 mm	8000041457



# Cable Ties and Cable Support for Trackers

## Secure and reliable cable management for solar installations

### Securing Solar Power for the Future

B

In solar farms, where exposure to sun and wind challenge every connection, cable management becomes crucial. With miles of cables carrying energy across the installation, the focus isn't just on organization –it's on long-term security. Weidmüller's cable management solutions ensure that cables are securely fastened, resilient to extreme weather, and optimized for durability, providing peace of mind throughout the life of the system.



### Key features & benefits

- **UV-resistant plastic cable ties** – Designed to securely hold cables ranging from 25mm to 380mm in diameter, these ties withstand harsh UV exposure, ensuring lasting reliability and durability.
- **Robust stainless steel cable ties** – For tougher environments, these ties manage cables between 50mm and 370mm in diameter, offering secure and durable performance where plastic solutions fall short.
- **Advanced cable support for solar trackers** – Specialized solutions for securing cables to torque tubes in solar trackers. Built for dynamic environments, these supports maintain long-term performance even in challenging conditions.



## Ordering data for Cable Ties and Cable Support for Trackers

### Weather-resistant plastic Cable Tie (UV resistant) – black color

Material: PA 66 with UV-resistant additives. Flammability: UL94 V2. Operating temperature: -40°C to 85°C.

Description	Maximum bundling diameter (mm)	Minimum breaking tension (N)	QTY	Order No.
Cable ties, 2.5 x 98 mm	21	80N	100	2659370000
Cable ties, 3.5 x 140 mm	32	130N	100	2659320000
Cable ties, 4.8 x 200 mm	50	220N	100	2659340000
Cable ties, 4.5 x 290 mm	78	220N	100	2659350000
Cable ties, 7.5 x 365 mm	100	540N	100	2659360000



### Uncoated stainless-steel clamp

Material: Stainless Steel AISI 316L. Operating temperature: -80°C to 538°C.

Description	Maximum bundling diameter (mm)	Minimum breaking tension (N)	QTY	Order No.
Cable ties, 4.6 x 200 mm	50	778	100	2791400000
Cable ties, 4.6 x 360 mm	100	778	100	2791410000
Cable ties, 4.6 x 520 mm	150	778	100	2791420000
Cable ties, 4.6 x 680 mm	200	778	100	2791430000
Cable ties, 4.6 x 840 mm	250	778	100	2791440000
Cable ties, 7.9 x 200 mm	50	1112	100	2791450000
Cable ties, 7.9 x 360 mm	100	1112	100	2791460000
Cable ties, 7.9 x 680 mm	150	1112	100	2791480000
Cable ties, 7.9 x 840 mm	200	1112	100	2791490000



### Polyester Coated stainless steel clamp

Material: Stainless Steel AISI 316L. Operating temperature: -80°C to 538°C.

Description	Maximum bundling diameter (mm)	Minimum breaking tension (N)	QTY	Order No.
Cable ties, 4.6 x 259 mm	50	445	100	1015250000
Cable ties, 4.6 x 521 mm	150	445	100	1015280000
Cable ties, 4.6 x 681 mm	200	445	100	1015290000
Cable ties, 4.6 x 840 mm	250	445	100	1015300000
Cable ties, 7.9 x 201 mm	50	1112	100	1015310000
Cable ties, 7.9 x 362 mm	100	1112	100	1015320000
Cable ties, 7.9 x 681 mm	150	1112	100	1015340000



### Tracker cable support

Description	Support thickness	Coating	Tracker	Order No.	Max Op. Temp	Order No.
Tracker Cable Support MT-303-3 GEO	3 mm	Geomet 800 B	NextTracker	4000010681	+45 °C	8000157248
Tracker Cable Support MT-303-3 ELEC	3 mm	ZN CS3	NextTracker	4000010682	+45 °C	8000157249
Tracker Cable Support MT-303-4 GEO	4 mm	Geomet 800 B	NextTracker	4000010683	+45 °C	8000157254
Tracker Cable Support MT-303-4 ELEC	4 mm	ZN CS3	NextTracker	4000010684	+45 °C	8000112715
Tracker Cable Support MT-305 ELEC	4 mm	ZN CS3	Soltec - STI	4000010685	+45 °C	8000157250



# PV AC Combiner Boxes String Inverter Concept

## B

### Bundle and protect PV string inverters in utility-scale systems reliably and economically

For solar installations in the PV industry, reliability and availability are paramount. In systems with string inverters, our AC combiner boxes provide optimal short-circuit and overvoltage protection. Furthermore, each string inverter can be easily isolated from the system to do maintenance tasks.

The new PV AC Combiner boxes have been designed for PV systems with string inverters in trackers or fix tilt systems. The product portfolio is suitable for inverters from 60 kW up to 200 kW and support voltages of 400 V, 690 V or 800 V AC. The combiner boxes allow to collect from 2 up to 6 string inverters in one single cabinet. They withstand ambient temperatures from -20 up to +50°C to operate in hardest climate conditions, fulfilling the highest market standards as per IEC 61439-2 ed 3.0:2020.

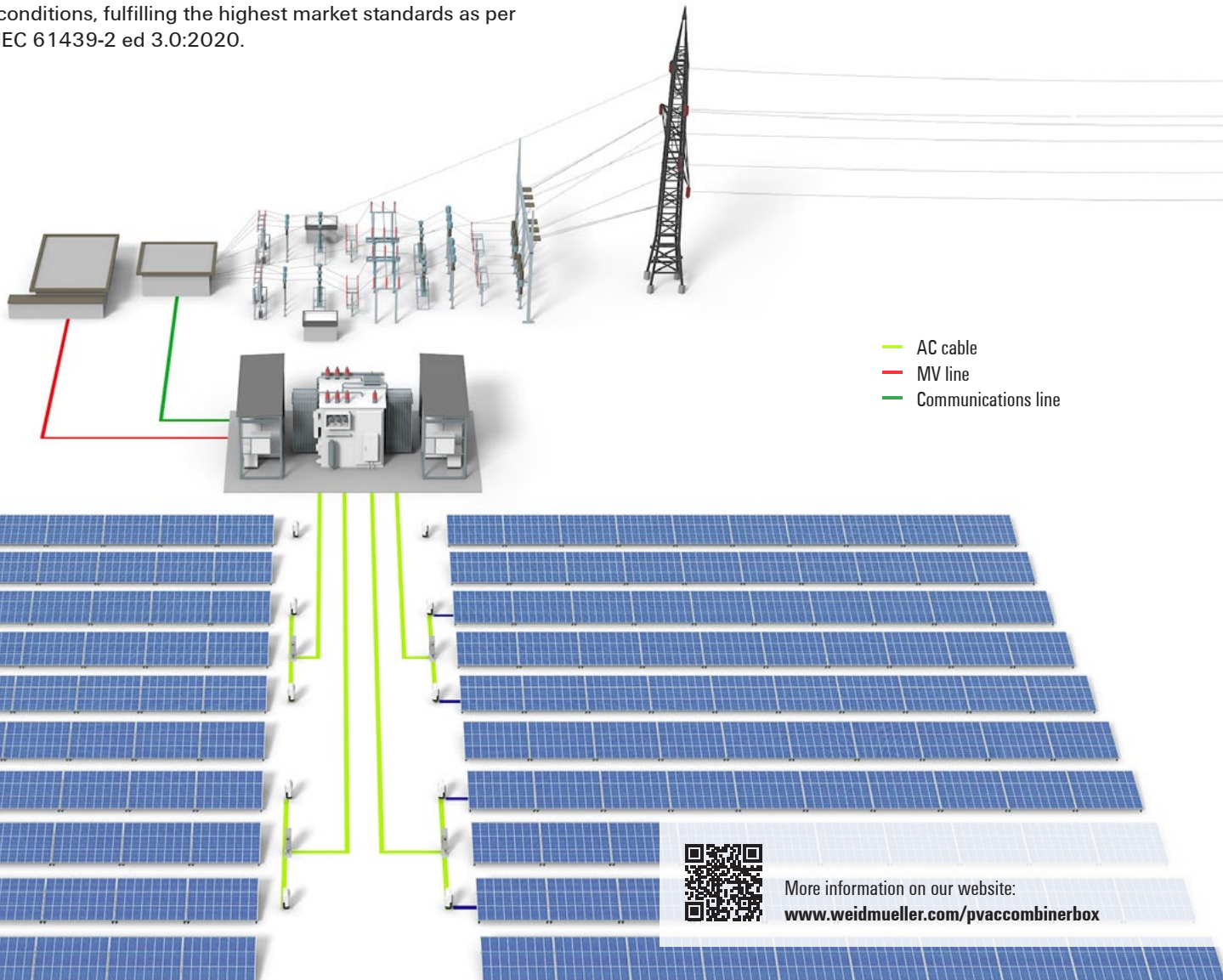

More information on our website:  
[www.weidmueller.com/pvaccombinerbox](http://www.weidmueller.com/pvaccombinerbox)



## Key features & benefits

- **Optimised design** – By using advanced simulation 3D softwares, the product variants have been designed and tested to operate at the maximum mechanical and thermal efficiency in the most compact housing size.
- **Technical data available online with 1-click** – We offer web tools to support the selection of the best model for the application. Technical data and certifications are available in the Weidmüller online catalogue.
- **Very resistant to short-circuits** – Designed to operate in solar power plants with high requirements of short circuit current.

### Technical data: PV AC Combiner Boxes

<b>Application data</b>	
Installation location	Protected outdoors
Altitude above the sea level	up to 2000m (standard) higher altitude on demand
Operating ambient temperature	-20°C up to 50°C
<b>Electrical characteristics</b>	
Rated voltage	400V AC - 690 V AC - 800 V AC
Number of inputs (inverters)	from 2 up to 6
Rated current per Input (InC)	85 A up to 200 A
Rated frequency (Hz)	50Hz
Short circuit strenght	120kA
Fuse link factir form	NH-00 / NH-01
Fuse link rating	85 A up to 250 A
Number of outputs	1
Protection class	Class II
Overvoltage protection	Type II or Type I+II
Earthing system	TN-S / TN-C
<b>Enclosure</b>	
Enclosure material	Glass Fiber Reinforced Polyester
Enclosure IP rating	IP65
Enclosure fixing system	Wall mounted or pedestal
Form factor	Cabinet with hinged door
Polycarbonate protection cover	Yes
<b>Inputs</b>	
Input cable	4x70mm <sup>2</sup> or 4x95mm <sup>2</sup>
Input cable gland	M50
<b>Outputs</b>	
Output cable	1 x 240mm <sup>2</sup>
Output cable gland	M40
<b>Others</b>	
Main switch disconnecter	Yes (optional)
<b>Standards</b>	
Compliant standards	IEC 61439-2 ED 3

### Ordering data: PV AC Combiner Boxes

Type	Inputs	Outputs	Rated voltage	Fuse-link rated current	Monitoring	Type of enclosure	Enclosure size	Qty.	Order No.
PV 40601S2V1C0A1ES	6	1	400 V AC	100 A	No	Landscape	850 x 1000 x 350 mm	1	8000069105
PV 40301S2V1C2A1ES	3	1	400 V AC	160 A	No	Portrait	1000 x 800 x 300 mm	1	8000069106
PV 40401S2V1C1A1ES	4	1	400 V AC	125 A	No	Portrait	1000 x 800 x 300 mm	1	8000069107
PV 40401S2V3C0A0ES	4	1	690 V AC	100 A	No	Portrait	800 x 600 x 300 mm	1	8000069108
PV 40201S2V3C1A0ES	2	1	690 V AC	125 A	No	Portrait	800 x 600 x 300 mm	1	8000069109
PV 40201S2V4C0A0ES	2	1	800 V AC	100 A	No	Portrait	800 x 600 x 300 mm	1	8000069110
PV 40201S2V4C2A0ES	2	1	800 V AC	160 A	No	Portrait	800 x 600 x 300 mm	1	8000069111

# PV AC Switch Boxes

## Essential Protection for Utility-Scale Solar Inverters

### Role of AC Switch Boxes in Solar Installations

AC Switch Boxes play a critical role in utility-scale solar photovoltaic (PV) systems, ensuring both operational efficiency and safety. Specifically designed for use with utility-scale string inverters, these boxes provide a reliable means of isolating the AC output from the inverter. This isolation is essential during maintenance, emergency shutdowns, or grid disconnections, enabling operators to perform tasks without risking damage to the system or electrical hazards. By enabling safe and efficient AC disconnection, AC Switch Boxes help protect both the equipment and the personnel working on the system. Their functionality is key to ensuring that utility-scale PV systems operate smoothly, with minimal downtime, and in compliance with stringent safety standards.



### Key features & benefits

- **Reliability and safety features** – Integrated load-break switches or circuit breakers capable of handling high voltage and current, ensuring compliance with electrical safety standards and enhancing system flexibility.
- **Durable and weather-resistant design** – Housed in rugged enclosures with IP-rated protection, these switch boxes are built to endure harsh environmental conditions, making them ideal for outdoor use.
- **Enhancing maintenance and grid stability** – Providing a secure and centralized AC disconnection point, these boxes streamline maintenance, minimize downtime, and contribute to grid stability and operational efficiency in large solar projects.

Type	Rated Voltage	Rated Current	# of poles	Compatible Inverters	Type of enclosure	Enclosure Size (mm)	Max Oper. Temp	Order No.
PV 403SXV4NHXXC5S01VXA0PWW	800 V AC	315 A AC	3	Huawei SUN2000 175 KTL-H0 Huawei SUN2000 185 KTL-INH0 Huawei SUN2000 185 KTL-INH1 Huawei SUN2000 190 KTL Huawei SUN2000 196 KTL-H0 Huawei SUN2000 200 KTL -H2 Huawei SUN2000 215 KTL - H0 SunGrow SG 125CX SunGrow SG 250HX	Portrait	747 x 536 x 300 mm	45°C	8000145928
PV 403SXV4NHXXC6S01VXA0PWW	800 V AC	400 A AC	3	Huawei SUN2000 250 KTL Huawei SUN2000 280 KTL Huawei SUN2000 300 KTL Huawei SUN2000 330 KTL SunGrow SG 285HX SunGrow SG 320HX SunGrow SG 333HX SunGrow SG 350HX	Portrait	847 x 636 x 300 mm	45°C	8000145929



# PV String Monitoring System

## Monitoring solutions

### Modular PV string monitoring system for up to 32 strings

In ground-mounted photovoltaic systems, the electrical parameters of the PV strings must be constantly monitored. This is the only way owners and operators can maintain the performance and yield of their systems in the long term. The new PV String Monitoring System is integrated into the DC combiner boxes of plants with central inverters. It is designed to monitor the current and voltage of the individual strings as well as the current SPD and breaker status in the combiner box. Due to its modular design, the system can monitor up to 32 strings and measure up to 50 A per string. It is powered by plant current, can communicate wirelessly, and has low heat emission. All versions of the system can be powered either by 1500V DC or 24V DC, regardless of the selected communication method. Additionally, fiber optic communication options are available alongside the standard configurations.

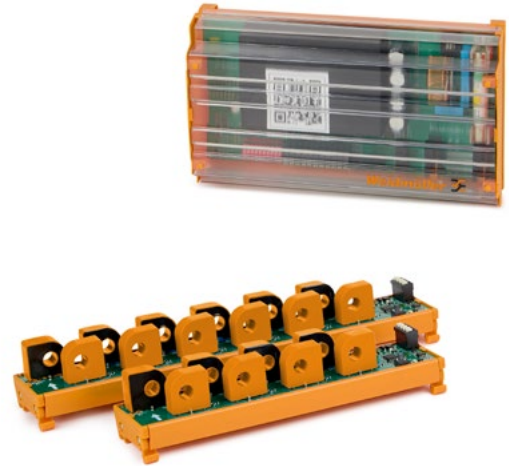

#### Compact and powerful

It can monitor up to 32 strings and measure up to 50 A per string.



#### Wireless communication capability

The system can transmit data either via RS-485 cable or wirelessly to the SCADA system.



#### Modular design

It allows monitoring of up to 3-string inputs as well as high-power and bifacial solar panels.

### Key features & benefits

- PV String Monitoring System (SMS) allows to control & monitor major string parameters, enhancing solar production of a solar plant
- Monitoring of major combiner box variables (string current & voltage, switch & SPD status, temperature, etc.)
- Monitor up to 32 strings (single, double or triple)
- String current monitoring up to 50 A for new high-power and bifacial solar panels
- Voltage string monitoring up to 1500 V (also suitable for 1000 V PV solar systems)
- Flexible power supply: Can be powered by 1500V DC or 24V DC
- Hall effect sensor monitoring with low power/heat dissipation, ensuring long-term performance of PV DC Combiner Box components
- 99% measurement accuracy for all monitored variables
- Multiple communication options: RS-485, fiber optic, and optional wireless LoRaWAN® (for complete PV DC combiner box solutions only)



### Technical data: PV String Monitoring System

Application data	
Installation location	Protected outdoors
Altitude above the sea level	up to 2000m (standard) higher altitude on demand
Operating ambient temperature	-20°C up to 70°C
Electrical characteristics	
Operating voltage	1000V DC to 1500V DC
Voltage supply	from 200V up to 1500V
Number of inputs	from 8 up to 32
Available modules	8 channels and 12 channels
String Current measurement range	up to 50 A
Measurement accuracy	1%
Power supply	integrated DC/DC converter
Measurement technology	Hall effect sensors
Number of digital inputs	2
Communications	
Communication technology	RS-485, Optic Fibre or wireless (LoRAWAN)
Communication protocol	Modbus RTU / LoRAWAN
Surge protection communication port	Yes
Overcurrent protection	Yes
BaudRate	19200 bps (default)
Modbus timeout	1 second
Measurement variables	Voltage, current, temperature, SPD status, switch isolator status and auxiliary alarms
Standards	
Standards	EN 61326-1:2013 EN 62311:2020 EN 62109-1:2010

### Ordering data: PV String Monitoring System

Type	Type of unit	Operating voltage	Communication type	Number of monitored channels	Max current/channel	Measurement technology	Number of digital inputs	Qty.	Order No.
SOLAR SMS MASTER	Master - main board	<1500 V DC	RS-485 / Modbus RTU	Controls up to 32 channels	-	N/A	2	1	4000002958
SOLAR SMS SLAVE 8IN25A	Slave - current sensor board	-	RS-485 / Modbus RTU	8 inputs	25 A	Hall effect	-	1	4000002959
SOLAR SMS SLAVE 12IN25A	Slave - current sensor board	-	RS-485 / Modbus RTU	12 inputs	25 A	Hall effect	-	1	4000002961
SOLAR SMS SLAVE 8IN50A	Slave - current sensor board	-	RS-485 / Modbus RTU	8 inputs	50 A	Hall effect	-	1	4000003982
SOLAR SMS SLAVE 12IN50A	Slave - current sensor board	-	RS-485 / Modbus RTU	12 inputs	50 A	Hall effect	-	1	4000003983
SOLAR SMS MASTER OPTIC FIBRE PRO	Master - main board	<1500 V DC	Fibre Optic/Modbus RTU	Controls up to 32 Channels	-	N/A	2	1	4000010509
SOLAR SMS MASTER 24VDC PRO	Master - main board	24 V DC	RS-485/Modbus RTU	Controls up to 32 Channels	-	N/A	2	1	4000010651
SOLAR SMS MASTER LORAWAN PRO	Master - main board	<1500 V DC	LoRa/LoRaWAN	Controls up to 32 Channels	-	N/A	2	1	4000010652
SOLAR SMS MASTER LORAWAN 24VDC PRO	Master - main board	24 V DC	LoRa/LoRaWAN	Controls up to 32 Channels	-	N/A	2	1	4000010653

# PV Retrofit Boxes with LoRaWAN® Communication

## Smart monitoring solutions for existing PV power plants

### Upgrade Monitoring without Major Modifications

Weidmüller's PV Retrofit Boxes offer a smart solution to enhance string-level data acquisition in existing photovoltaic (PV) power plants without the need for expensive infrastructure changes or major system overhauls. These retrofit boxes are designed to integrate seamlessly with older PV systems, enabling modern, real-time monitoring and performance optimization without disrupting ongoing operations. By retrofitting older systems with Weidmüller's advanced monitoring solutions, operators can gain valuable insights into the performance of individual strings, detect faults more effectively, and improve overall system efficiency – while avoiding the high costs and complexities of a full system upgrade.

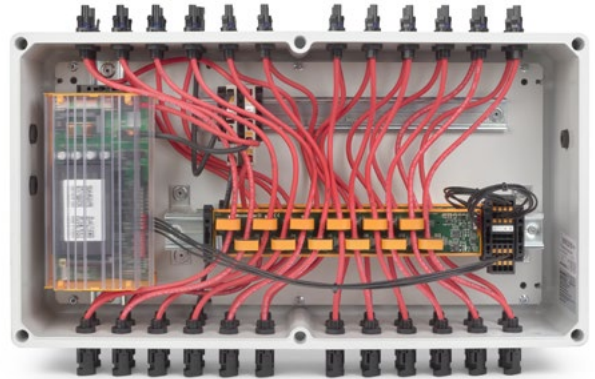

### Key features & benefits

- **Expertise in PV communication** – Built on Weidmüller's extensive experience in both photovoltaic and industrial communication technologies, these retrofit boxes offer reliable, scalable solutions for improving monitoring and performance.
- **Seamless wireless data collection with LoRaWAN®** – LoRaWAN® technology ensures efficient data collection from PV strings, even from non-monitored combiner boxes, minimizing installation complexity and eliminating the need for extensive cabling.
- **Simplified deployment & lower maintenance costs** – By reducing the need for additional communication cabling, PV Retrofit Boxes streamline installation and lower long-term maintenance costs while improving fault detection, asset management, and system analytics.
- **Centralized data management with u-control** – The u-control data logger aggregates data via Modbus TCP, providing seamless integration with SCADA systems and offering advanced analytics for optimized plant performance.
- **A smart, future-ready upgrade** – Designed for long-term performance, Weidmüller's PV Retrofit Boxes are cost-effective and scalable, making them a smart investment for enhancing the efficiency and reliability of your PV plant.

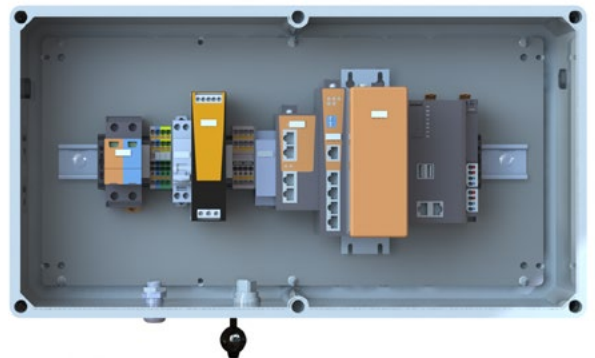

Description	Inputs	Max. Current Measurement	Cable input (*)	Enclosure Size	Max Op. Temp	Order No.
PV 208SXFCCXXVX00TA3PA15LWW	8	23 A	CG	558 x 302 x 210 mm	+45°C	8000157248
PV 208SXFCCXXVX01TA3PA15LWW	8	23 A	WM4 C	558 x 302 x 210 mm	+45°C	8000157249
PV 212SXFCCXXVX00TA3PA15LWW	12	19 A	CG	558 x 302 x 210 mm	+45°C	8000157254
PV 212SXFCCXXVX01TA3PA15LWW	12	25 A	WM4 C	558 x 302 x 210 mm	+45°C	8000112715
PV 216SXFCCXXVX00TA3PA15LWW	16	16 A	CG	558 x 302 x 210 mm	+45°C	8000157250
PV 216SXFCCXXVX01TA3PA15LWW	16	16 A	WM4 C	558 x 302 x 210 mm	+45°C	8000112718
PV 224SXFCCXXVX00TA3PA15LWW	24	13 A	CG	558 x 302 x 210 mm	+45°C	8000157251
PV 224SXFCCXXVX01TA3PA15LWW	24	13 A	WM4 C	558 x 302 x 210 mm	+45°C	8000122018
PV 232SXFCCXXVX01TA3PA15LWW	32	11 A	WM4 C	558 x 302 x 210 mm	+45°C	8000157252
PV 232SXFCCXXVX00TA3PA15LWW	32	11 A	CG	558 x 302 x 210 mm	+45°C	8000157253

# Advanced DC Harnessing

## Smart string monitoring for central inverter systems

### The Challenge

In large-scale solar farms utilizing central inverters, DC harnesses are crucial for collecting energy from multiple PV strings. However, the absence of real-time monitoring at the string level can lead to undetected issues, such as blown fuses or cable degradation. These problems, if left unchecked, can cause significant energy losses, system inefficiencies, and potentially costly repairs. Without visibility into the performance of each individual string, operators may face unanticipated downtime and increased operational costs. Ensuring early detection and resolution of such issues is vital for maintaining system performance and maximizing energy yield in these large-scale installations.

### Key features & benefits

- **String-level monitoring** – Provides detailed insights into individual string performance, detecting issues such as fuse failures to prevent energy losses.
- **LoRaWAN wireless communication** – Ensures secure, long-range data transmission without the need for complex wiring, simplifying the installation process.
- **Faster fault detection** – Minimizes downtime by enabling rapid identification of issues, ensuring that the system operates at peak efficiency.
- **Easy integration** – Fully compatible with both new and retrofitted harness systems, making it a versatile solution for a range of PV installations.
- **Improved O&M efficiency** – Supports predictive maintenance, helping to reduce the need for site visits and enhancing overall operational efficiency.

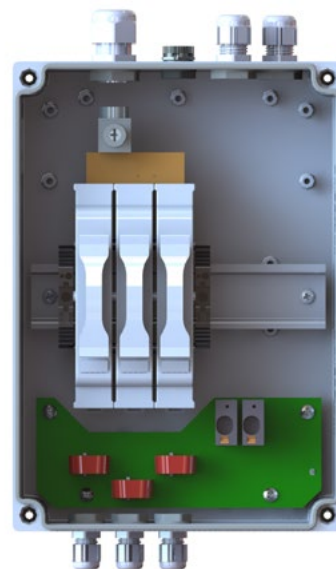

B



# PV Communication Boxes

## Plant Communication

**B**

### Connecting photovoltaic power plants through reliable and safe industrial communications

We combine extensive experience with photovoltaic projects and industrial communication to create a complete portfolio of PV communication cabinets for PV power plants.

Our portfolio offers certified and ready-to-use cabinets for PV power plants that meet the specific environmental, electrical and data transmission requirements according to customer specifications. Weidmüller can customise the communication infrastructure requirements of the PV power plant, enabling perfect data collection for the plant owner, ultimately improving the long-term investment.

### Key features & benefits

- Safe function due to optimal protection
- Maximum availability due to integrated energy backup
- Highly reliable industry standard with built-in communication protocols
- High cost-effectiveness through modular designs based on standard references
- TCP/RS cards for RS485 field buses
- IP certification for outdoor or indoor use

**Power supply**  
24 VDC @ 3 ADC

**RJ45 Switch & Fibre-optic Converter**  
IE managed switch 6x RJ-45 ports  
2x SC Multi-mode ports

**Fibre-optic patch panel box**  
6x SC Multi-mode fibre-optic ports

**Battery & UPS**

Battery 24 VDC @ 3.4 Ah  
UPS 24 VDC @ 20 A/10 A

**2 x Serial / Ethernet converter**

Serial / Ethernet converter  
2x RJ45  
2x DB9 for RS-485

**u-control with multiple I/O**

u-control controller  
16x Digital inputs  
4x Analogue inputs  
8 GB data storage

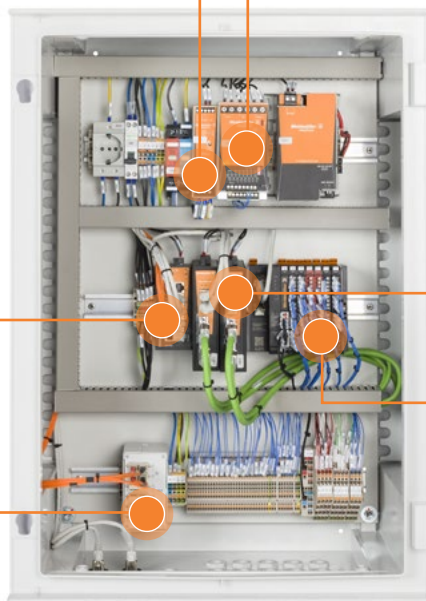

**Other designs on request**

Simply contact us and describe the application and the requirements for the PV Communication Box. We will then provide you with a custom-fit design and quote:

[www.weidmueller.com/pvcommunicationbox](http://www.weidmueller.com/pvcommunicationbox)

# PV Weather Boxes

## Plant Communication

### Increase your energy production, monitor your system output

To ensure optimal performance of photovoltaics systems, continuous and precise monitoring is essential. Environmental factors directly influence the efficiency of solar modules, which is why real-time data collection is crucial to maximising energy output and identifying potential system efficiencies early on.

Our PV weather stations provide reliable and accurate measurements of all critical meteorological parameters, including ambient and module temperature, solar radiation (global horizontal and module field level). Wind speed and direction, precipitation level, relative humidity and air pressure. These high-precision sensors provide a comprehensive analysis of weather conditions that affect PV performance, enabling proactive system adjustments and performance optimisation. Our weather stations are designed to meet customer-specific requirements. They have certified enclosures that can withstand even harsh environmental conditions. Flexible integration with SCADA systems and various data acquisition platforms is achieved using industry-standard communication protocols such as Modbus RTU and TCP. Advanced data transfer options, including wireless connectivity, guarantee seamless remote monitoring.

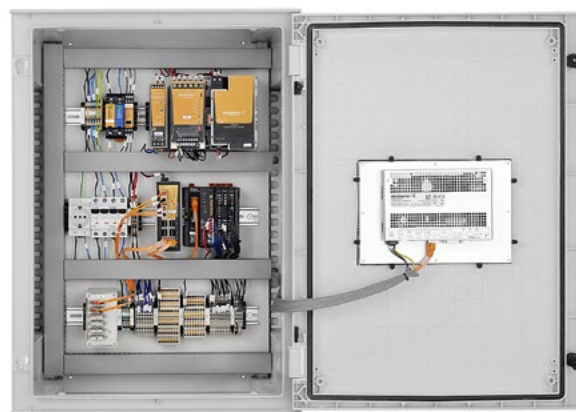

#### We use the best-known brands of weather sensors

The PV weather stations from Weidmüller integrate the best-known weather sensors on the market. The systems are extremely robust and protected against all weather conditions.



### Key features & benefits

- Reliable function due to optimal protection
- Maximum availability due to integrated power backup
- High cost-effectiveness through modular designs based on standard references
- IP certification for outdoor or indoor use
- Connection of the required weather sensors via modular I/O cards
- Robust construction and protection against all weather conditions
- Sensors are included in the scope of delivery



## PV Weather Boxes Plant Communication

Robust and durable capacitive multi-touch panel monitor for data visualisation and HMI

Safe switching, protection and integrated energy back-up

Modular I/O cards for connecting sensors to manage digital/analogue signals

Modular designs based on standard references

IP degree certified for outdoor or indoor solutions

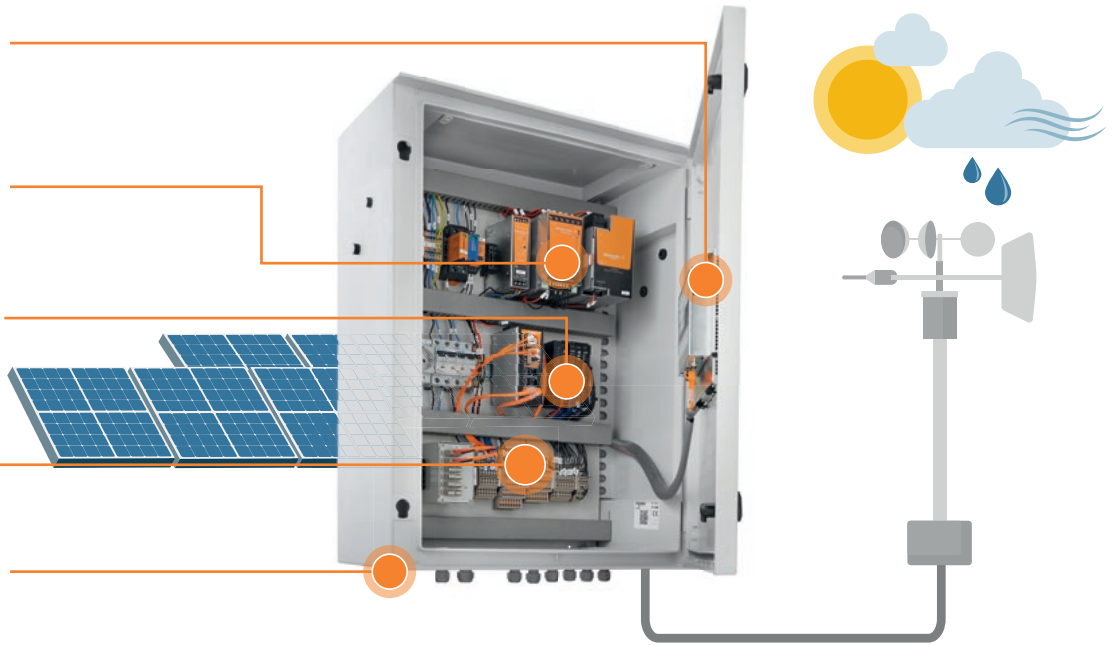

### PREMIUM Versions On Grid

Specification	8000094711 PV WC111RXPXG1SXM2S6WW	8000157322 PV WC11XRXPXG1SXM2S6WW
Controller Web-based	●	
IE Network Managed Switch 6x RJ45 / 2x SC Multi-mode	●	●
Serial/Ethernet converter and Modbus TCP/RTU gateway	●	●
UPS control unit 24V 20 A/10 A	●	●
Battery 24 V 3,4 AH	●	●
AC Single-phase Type I SPD		●
Ethernet Data Interface SPD	●	●
RS-485 Data Interface SPD	●	●
Enclosure Shape	Portrait	Portrait
Enclosure Size (mm)	747 x 536 x 300	747 x 536 x 300
IP Degree	IP66	IP66
Operating Ambient Temperature	-20 °C .. +50°C	-20 °C .. +50°C

### Premium Version Hybrid On Grid - Off Grid

Specification	8000144152 PV WC11XRXPXG1SXM4S6WW
Controller Web-based	●
Serial/Ethernet converter and Modbus TCP/RTU gateway	
Battery Regulator (*)	●
AC Single-phase Type I SPD	
Ethernet Data Interface SPD	●
RS-485 Data Interface SPD	
Enclosure Shape	Portrait
Enclosure Size (mm)	847 x 636 x 300
IP Degree	IP66
Operating Ambient Temperature	-20 °C .. +50°C

- On-grid/off-grid behaviour with battery and PV panel support (battery and PV panel not included).
- Battery solar charger is compatible with several common lead-based battery technologies such as AGM, Gel, OPzS, OPzV, traction batteries, lithium and other battery chemistries.
- Weather station autonomy of 60 hours (with a limitation of 5 sensors connected) can be achieved with a standard battery of lithium 100AH and 100W PV panel (available PN 8000148396).
- Different battery capacity and PV panels configuration are possible to achieve longer battery autonomy (with PV panel support).



## LITE Versions

Specification	8000113427 PV WC11XRXPXG1SXMXS6WW	8000113428 PV WC11XRXPXG2SXMXS6WW
Controller Web-based	●	●
Serial/Ethernet converter and Modbus TCP/RTU gateway	●	●
AC Single-phase Type I SPD	●	●
Ethernet Data Interface SPD	●	●
RS-485 Data Interface SPD	●	●
Enclosure Shape	Portrait	Portrait
Enclosure Size (mm)	530 x 430 x 200	530 x 430 x 200
IP Degree	IP66	IP66
Operating Ambient Temperature	-20 °C .. +50°C	-20 °C .. +50°C

## Ordering data: PV Weather Boxes

Description	Type	Order No.
PYRANOMETER SMP10A KIPP-ZONEN	PYRANOMETER	4000007576
PYRANOMETER SR30-M2-D1-05 HUKSEFLUX	PYRANOMETER	4000005453
PYRANOMETER SPN1 DELTA-T	PYRANOMETER	4000007575
PYRANOMETER SMP12 KIPP-ZONEN	PYRANOMETER	4000007577
PYRANOMETER SUN-E 2ND STD LAMBRECHT	PYRANOMETER	4000006021
AMBIENT TEMPERATURE RK330-01ADA2500 RIKA	AMBIENT TEMPERATURE	4000007572
AMBIENT TEMPERATURE TAMBSI IMT-SOLAR	AMBIENT TEMPERATURE	4000007659
AMBIENT TEMP TAEXTRS485MB IMT-SOLAR	AMBIENT TEMPERATURE	4000005459
MODULE TEMPERATURE RK220-01CEA25000 RIKA	MODULE TEMPERATURE	4000007574
MODULE TEMPERATURE TMODULSI IMT-SOLAR	MODULE TEMPERATURE	4000007660
MODULE TEMP TMRS485MB IMT-SOLAR	MODULE TEMPERATURE	4000005452
SOILING MONITOR DUSTIQ KIPP-ZONEN	SOLAR IRRADIANCE/SOILING	4000007578
SOLAR IRRADIANCE SIRS485TC3TMB IMT-SOLAR	SOLAR IRRADIANCE/SOILING	4000007661
SOLAR IRRADIANCE SIRS485TC3TMB IMT-SOLAR	SOLAR IRRADIANCE/SOILING	4000007580
TOTAL UV RADIOMETER SUV5 KIPP-ZONEN	UV RADIOMETER	4000007582
COMBINED WIND SENSOR ARCO LAMBRECHT	WIND	4000007581
RAIN GAUGE RAIN-E-ONE LAMBRECHT	RAIN GAUGE	4000005450
AIO WEATHER STATION WS601-UMB LUFFT	AIO WEATHER STATION	4000005458
CABLE 10M-8WIRE SMP/CVF/SUV KIPP-ZONEN	CABLE	4000007771
CABLE 25M-8WIRE SMP/CVF/SUV KIPP-ZONEN	CABLE	4000007772
CABLE 50M-8WIRE SMP/CVF/SUV KIPP-ZONEN	CABLE	4000007773
CABLE 10M-8WIRE DUSTIQ KIPP-ZONEN	CABLE	4000007774
CABLE 25M-8WIRE DUSTIQ KIPP-ZONEN	CABLE	4000007775
CABLE 50M-8WIRE DUSTIQ KIPP-ZONEN	CABLE	4000005457
CABLE 10M-8WIRE CLIMASENSOR-US THIES	CABLE	4000007588
CABLE 5M-5WIRE SR30-M2-D1-05 HUKSEFLUX	CABLE	4000007589
CABLE 10M-5WIRE SR30-M2-D1-05 HUKSEFLUX	CABLE	4000007590
CABLE 20M-5WIRE SR30-M2-D1-05 HUKSEFLUX	CABLE	4000007571
CABLE 12M-4WIRE LAMBRECHT	CABLE	4000007591
TELESCOPIC MAST AL 3M LAMBRECHT	FIXATION ELEMENTS	4000007592
TRIPOD 3-LEG BASE AL LAMBRECHT	FIXATION ELEMENTS	4000007593
TRAVERSE SET AL PYRANOMETER LAMBRECHT	FIXATION ELEMENTS	4000007594
POLE BASE SS RAIN-E LAMBRECHT	FIXATION ELEMENTS	4000007595
BRACKET LARGE PYRANOMETER LAMBRECHT	FIXATION ELEMENTS	4000007675
POST FIXING PLM75 NSYSFP500 SE	FIXATION ELEMENTS	4000007719
LIGHTNING ROD LAMBRECHT	FIXATION ELEMENTS	4000005454
VENTILATION UNIT CVF4 KIPP-ZONEN	ACCESSORIES	4000005455
GLARE SCREEN KIT KIPP-ZONEN	ACCESSORIES	4000007579
SOLAR RADIATION SHIELD TAMBSI IMT-SOLAR	ACCESSORIES	4000007573
CABLE EXTENSION BOX JB-01 IMT-SOLAR	ACCESSORIES	4000007776

# MeteoSense

## Precision Monitoring for Solar Power Optimization

### The Importance of Environmental Monitoring in Solar Plants

B

In utility-scale solar plants, environmental monitoring plays a crucial role in optimizing efficiency and preventing energy losses. Weidmüller's MeteoSense, a specialized sensor family, provides real-time data on ambient and module temperatures, allowing operators to make informed decisions. These insights not only help in maximizing energy production but also extend the lifespan of the equipment by ensuring the system operates within optimal conditions. With MeteoSense, operators can adapt to environmental changes, thereby improving the performance of photovoltaic (PV) installations and increasing overall system reliability.

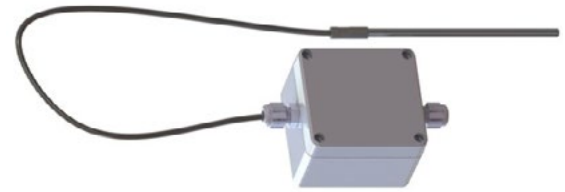
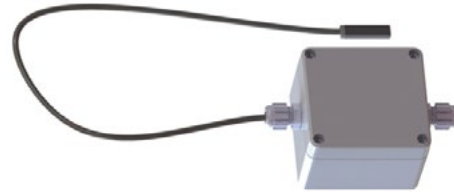

### Key features & benefits

- **Real-time temperature measurements** – Enhances Maximum Power Point Tracking (MPPT) efficiency and enables predictive maintenance by continuously monitoring ambient and module temperatures.
- **Detects hot spots** – Identifies potential thermal issues, mitigating risks and ensuring safe, reliable operation of the system.
- **High-precision performance** – Delivers accurate temperature readings even in harsh industrial and outdoor environments, making it ideal for utility-scale solar applications.
- **Precision leads to power** – With MeteoSense, every degree counts in optimizing the energy production of the solar plant.
- **MeteoSense Sensor Variants:**
  - ATS PT100 RS485** – Ambient temperature monitoring for weather forecasting and system optimization.
  - MTS PT100 RS485** – PV module temperature monitoring to prevent thermal degradation and enhance energy yield.

Description	Application	Recommended Mounting	Max Altitude (m)	Protection	Order No.
MeteoSense MTS PT100 RS485	PV module temperature measurement	Rear side of the module	2000	IEC 62208	<b>8000161015</b>
MeteoSense ATS PT100 RS485	Ambient temperature in PV fields	Ventilated radiation shield	2000	IEC 62208	<b>8000161014</b>





# PV Accessories

## For the easy system installation



### PV Tools

When installing a photovoltaic system, the installer depends on reliable and smooth-running tools. Weidmüller offers a range of professional tools for this purpose.

B



#### Stripping tools

Type	Cutting	Stripping	Qty.	Order No.
MULTI-STRIPAX PV	2,5, 4.0 and 6 mm <sup>2</sup>	2,5, 4.0 and 6 mm <sup>2</sup>	1	1190490000



#### Crimping tools

Type	Crimping	Description	Qty.	Order No.
CTF PV WM4	2,5...6 mm <sup>2</sup>	Crimping tool for Weidmüller photovoltaic connector WM4 C and identical connectors	1	1222870000



#### Cutting tools

Type	Maximum cutting performance	Copper finely stranded	Aluminium stranded	Qty.	Order No.
KT 12	25 mm <sup>2</sup>	35 mm <sup>2</sup>	16 mm <sup>2</sup>	1	9002660000



#### Multitool

Type	Description	Qty.	Order No.
MULTITOOL PV SET	Screw PV-Stick; Check cable diameter for PV-Stick; Put on smart lock for PV-Stick; Open cover for PV Next; Replace SPD cartridge for PV Next; Operate PUSH IN connection; Open control cabinet	1	2771530000



#### PV tool bag

Type	Description	Qty.	Order No.
PV TOOL STICK SET	Tool bag with belt; 30 pcs. PV-Stick + (crimless PV connector); 30 pcs. PV-Stick - (crimless PV connector); KT 8 cutting tool; SLICER cable knife; multi-stripax® PV; Multitool for PV sticks; 2 Mammut bags for carrying your PV sticks	1	2936970000



## PV Labels and Markers

### PV Cable marker

Type	Design	Colour	Kabelbinder Loch	Qty	Order No.
SFX-VT 9/24 MM GE	9 x 24 mm cable marker, with 1 cable tie punch hole, UV-resistant	●	6 x 1.9 mm	1000	2621460000
SFX-VT 9/24 MM WS	9 x 24 mm cable marker, with 1 cable tie punch hole, UV-resistant	○	6 x 1.9 mm	1000	2621470000
SFX-VT 9/24 MM RT	9 x 24 mm cable marker, with 1 cable tie punch hole, UV-resistant	●	6 x 1.9 mm	1000	2799310000
SFX-VT 9/24 MM BL	9 x 24 mm cable marker, with 1 cable tie punch hole, UV-resistant	●	6 x 1.9 mm	1000	2799320000
SFX-VT 11/60 MM GE	11 x 60 mm cable marker, with 2 cable tie punch hole, UV-resistant	●	5.5 x 2mm	1000	2621440000
SFX-VT 11/60 MM WS	11 x 60 mm cable marker, with 2 cable tie punch hole, UV-resistant	○	5.5 x 2 mm	1000	2621450000
SFX-VT 11/60 MM RT	11 x 60 mm cable marker, with 2 cable tie punch hole, UV-resistant	●	5.5 x 2 mm	1000	2900960000
SFX-VT 11/60 MM BL	11 x 60 mm cable marker, with 2 cable tie punch hole, UV-resistant	●	5.5 x 2 mm	1000	2900970000
<b>Ribbon: 2448880000 black</b>					



### PV Device marker

Type	Design	Colour	Qty	Order No.
THM PV 89/60 B/DR RT	Device marker, 60 x 89 mm	●	450	2817450000
THM PV 90/140 WBC	Battery warning, pre-printed warning label		200	2986860000
THM PV 90/140 WFF	Fire brigade warning, pre-printed warning label		200	2986850000
<b>Ribbon: 2005070000 black, 2918800000 white</b>				

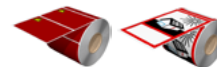

### Device markers endless

Type	Design	Colour	Qty	Order No.
THM PV EL 30 SI 30M	Device markers, 30 mm	●	1 roll, 30 m	2969100000
THM PV EL 30 WS 30M	Device markers, 30 mm	○	1 roll, 30 m	2969070000
THM PV EL 60 SI 30M	Device markers, 60 mm	●	1 roll, 30 m	2969090000
THM PV EL 60 WS 30M	Device markers, 60 mm	○	1 roll, 30 m	2969060000
THM PV EL 90 GE 30M	Device markers, 90 mm	●	1 roll, 30 m	2817440000
THM PV EL 90 RT 30M	Device markers, 90 mm	●	1 roll, 30 m	2817430000
THM PV EL 90 SI 30M	Device markers, 90 mm	●	1 roll, 30 m	2969080000
THM PV EL 90 WS 30M	Device markers, 90 mm	○	1 roll, 30 m	2969050000
<b>Ribbon: 2005070000 black, 2918800000 white</b>				



### Transparent labels

Type	Design	Colour	Qty	Order No.
THM PV 85/54 TR	PV-Device markers, 84.6 x 53.6 mm	transparent	450	2969120000
<b>Ribbon: 2005070000 black</b>				



### THM MultiMark -Thermal transfer printer

Type	Design	Qty	Order No.
THM MULTIMARK	Marking systems, thermal transfer printer, thermal transfer, 300 DPI, MultiMark, shrink sleeves, label rolls	1	2599430000
THM MMP CUTTER	Cutting kit - for automatic cutting of continuous markers	1	1331600000
<b>For printing MultiMark markers, shrink sleeves, label rolls, etc.</b>			



### PV marker set

Type	Design	Qty	Order No.
PV MARKER 1-3 MPP	Pre-printed cable markers 1-3 MPP, warning labels, cable ties	1	8000149520



### PV warning label

Type	Design	Qty	Order No.
TABPACK PV 90/100 WFF	Fire brigade warning, pre-printed warning label, bag	20	2817460000
TABPACK PV 90/100 WBC	Battery warning, pre-printed warning label, bag	20	2817470000
PV MARKER EMERGENCY POWER	Emergency power warning, pre-printed warning label	10	8000151275



### Cable tie

Type	Design	Strength in mm	Qty	Order No.
CB-UVR 98/2,5 BK	Cable tie, 2.5 x 98 mm, polyamide 66, 80 N	1	100	2659310000
CB-UVR 140/3,5 BK	Cable tie, 3.5 x 140 mm, polyamide 66, 130 N	1.1	100	2659320000
CB-UVR 200/3,5 BK	Cable tie, 3.5 x 200 mm, polyamide 66, 130 N	1.2	100	2659330000
CB-UVR 200/4,8 BK	Cable tie, 4.8 x 200 mm, polyamide 66, 220 N	1.35	100	2659340000
CB-UVR 290/4,5 BK	Cable tie, 4.5 x 290 mm, polyamide 66, 220 N	1.4	100	2659350000
CB-UVR 365/7,5 BK	Cable tie, 7.5 x 365 mm, polyamide 66, 540 N	1.8	100	2659360000





## PV Connectors

### PV-Stick with SNAP IN connection

No crimping tool, no lost time, no extra effort - the unique PV-Stick uses tried-and-tested SNAP IN technology. The fastest, easiest and safest way to wire up photovoltaic plants - literally in no time.

### WM4 C with crimp connection

Outstanding quality and ease of handling due to modern crimp connection.

The WM4 C is suitable for automated assembly as well as for manual installation in the field.

### PV-Stick - Photovoltaic connectors - SNAP IN connection

Type	Rated voltage (IEC) Rated current	Connection cross-section min. / max.	Continuous operating temperature min. / max.	Qty.	Order No.
<b>Socket</b>					
PV-STICK+ Qty.10	1500 V DC / 30 A	4 / 6 mm <sup>2</sup>	-40 °C...+85 °C	10	1303450000
PV-STICK+ Qty.50	1500 V DC / 30 A	4 / 6 mm <sup>2</sup>	-40 °C...+85 °C	50	1303460000
PV-STICK+ Qty.200	1500 V DC / 30 A	4 / 6 mm <sup>2</sup>	-40 °C...+85 °C	200	1303470000
<b>Pin</b>					
PV-STICK- Qty.10	1500 V DC / 30 A	4 / 6 mm <sup>2</sup>	-40 °C...+85 °C	10	1303490000
PV-STICK- Qty.50	1500 V DC / 30 A	4 / 6 mm <sup>2</sup>	-40 °C...+85 °C	50	1303500000
PV-STICK- Qty.200	1500 V DC / 30 A	4 / 6 mm <sup>2</sup>	-40 °C...+85 °C	200	1303510000
<b>PV-Stick Set</b>					
PV-STICK SET	1500 V DC / 30 A	4 / 6 mm <sup>2</sup>	-40 °C...+85 °C	1	1422030000



### WM4 C - Crimp connectors

Type	Rated voltage / current	Conductor cross-section	Connection	Qty.	Order No.
<b>Box connectors - housing</b>					
SFGH BOX WM4 C BT	1500 V DC (IEC) / 35 A	4 / 6 mm <sup>2</sup>	M 12 housing cable gland	100	1530640000
BUGH BOX WM4 C BT	1500 V DC (IEC) / 35 A	4 / 6 mm <sup>2</sup>	M 12 housing cable gland	100	1530630000
<b>Field connector housing</b>					
SFGH WM4 C BT	1500 V DC (IEC) / 35 A	4 / 6 mm <sup>2</sup>	M 16 housing cable gland	100	1530700000
BUGH WM4 C BT	1500 V DC (IEC) / 35 A	4 / 6 mm <sup>2</sup>	M 16 housing cable gland	100	1530690000
<b>Crimp contacts</b>					
BUKO WM4 C BT	Socket contact	4 and 6 mm <sup>2</sup> cables	Loose goods for crimping tools	100	1530670000
BUKO WM4 C RL	Socket contact	4 and 6 mm <sup>2</sup> cables	Reel packaged goods for automated crimping	1500	1530770000
SFKO WM4 C BT	Pin contact	4 and 6 mm <sup>2</sup> cables	Loose goods for crimping tools	100	1530680000
SFKO WM4 C RL	Pin contact	4 and 6 mm <sup>2</sup> cables	Reel packaged goods for automated crimping	1500	1530780000



### Accessories

Type	Description	Qty.	Order No.
SAFETY-CLIP WM4 Qty.10	Locking clip for PV-Stick prevents opening without tools	10	1328150000
VSSO WM4 C	Sealing cap for protecting PV connectors that are not mated (all connectors)	100	1254870000



### PV AC output connectors (suitable for Huawei / Sungrow / SMA)

Type	Description	Rated voltage / current	Clamping range min. / max.	Qty.	Order No.
PV BSS VAPM 5P M	Box coupling 5 pole	600 V AC / 60 A	0.2mm <sup>2</sup> - 16mm <sup>2</sup>	1	2920100000
PV PS VAPM 5P F	Field connector 5 pole	600 V AC / 60 A	0.2mm <sup>2</sup> - 16mm <sup>2</sup>	1	2920110000
PV BSS DL	Cover	-	-	1	2920120000
PV PS ULTA	Lock	-	-	1	2920130000





### PV Fuses

The gPV cylindrical fuse cartridges are designed to provide compact, safe and economical protection of photovoltaic modules. They protect against both overloads and short circuits.

#### When are fuses required?

According to IEC 62548, fuses are required if the reverse current of the module is exceeded. This is calculated as follows:

String current x 1.25 x (number of strings - 1) = Larger max. reverse current, then fuse holder for + and -.

#### Which size should I use?

Multiply the ISC value of the module by 1.5.

Example:

8.99 A x 1.5 = 13.485 rounded up to 15 A fuse cartridges

#### 10x38 gPV fuse cartridges with silver-plated contacts for PV applications

Type	Voltage / Current	Power loss	Switching capacity	Qty.	Order No.
FUSE 10X38 1A 1000 VDC GPV	1000 V DC / 1 A	2.2 W	30 kA	10	2783160000
FUSE 10X38 2A 1000 VDC GPV	1000 V DC / 2 A	2.4 W	30 kA	10	2783170000
FUSE 10X38 3A 1000 VDC GPV	1000 V DC / 3 A	2.65 W	30 kA	10	2783180000
FUSE 10X38 4A 1000 VDC GPV	1000 V DC / 4 A	2.7 W	30 kA	10	2783190000
FUSE 10X38 5A 1000 VDC GPV	1000 V DC / 5 A	0.76 W	30 kA	10	2783200000
FUSE 10X38 6A 1000 VDC GPV	1000 V DC / 6 A	3.2 W	30 kA	10	2783210000
FUSE 10X38 8A 1000 VDC GPV	1000 V DC / 8 A	1.45 W	30 kA	10	2783220000
FUSE 10X38 10A 1000 VDC GPV	1000 V DC / 10 A	1.66 W	30 kA	10	2783230000
FUSE 10X38 12A 1000 VDC GPV	1000 V DC / 12 A	1.57 W	30 kA	10	2783240000
FUSE 10X38 15A 1000 VDC GPV S	1000 V DC / 15 A	1.65 W	33 kA	10	2827970000
FUSE 10X38 16A 1000 VDC GPV S	1000 V DC / 16 A	1.84 W	10 kA	10	2837520000
FUSE 10X38 20A 1000 VDC GPV S	1000 V DC / 20 A	2 W	10 kA	10	2827980000
FUSE 10X38 25A 1000 VDC GPV S	1000 V DC / 25 A	3.5 W	10 kA	10	2827990000
FUSE 10X38 30A 1000 VDC GPV S	1000 V DC / 30 A	3.8 W	10 kA	10	2828000000



### Cables

#### Y cable

Type	Power input 1 / input 2	Power output	Stich connection	Qty.	Order No.
PVHYW-XXW+XX06W+15	WM4C -	WM4C +	WM4C +	1	2814180000
PVHYW+XXW-XX06W-15	WM4C +	WM4C -	WM4C -	1	2814190000
PVHYM-XXW+XX06M+15	MC4 -	MC4 +	WM4C +	1	2814200000
PVHYM+XXW-XX06M-15	MC4 +	MC4 -	WM4C -	1	2814210000
PVHYW-XXPXX06W+15	WM4C -	WM4C +	Teil abisoliert	1	2814220000
PVHYM-M-XXX06W+15	MC4 -	WM4C+	MC4 -	1	2877850000
PVHYM+M+XXX06W-15	MC4 +	WM4C-	MC4 +	1	2877860000
PVHYM-XXM+XX06M+15	MC4+	MC4-	MC4-	1	3032100000
PVHYM+XXM-XX06M-15	MC4-	MC4+	MC4+	1	3032110000



#### Pre-assembled cables

Type	Voltage	Cable end version	Art des Steckkontakts	Steckverbinderausführung	Leitungslänge	Best.-Nr.
PV XSTU06 BUOWM4C-C250	1500 V DC	1x Steckverbinder, 1x offen	1x Buchse	1x WM4C	2500 mm	3010170250
PV XSTU06 STOWM4C-C250	1500 V DC	1x Steckverbinder, 1x offen	1x Stift	1x WM4C	2500 mm	3018430250
PV XSTU04 BUOWM4C-C250	1500 V DC	1x Steckverbinder, 1x offen	1x Buchse	1x WM4C	2500 mm	3018440250
PV XSTU04 STOWM4C-C250	1500 V DC	1x Steckverbinder, 1x offen	1x Stift	1x WM4C	2500 mm	3018450250
PV XSTU06 BU0EVO2-C250	1500 V DC	1x Steckverbinder, 1x offen	1x Buchse	1x MC4-Evo 2	2500 mm	3018460250
PV XSTU06 ST0EVO2-C250	1500 V DC	1x Steckverbinder, 1x offen	1x Stift	1x MC4-Evo 2	2500 mm	3018470250
PV XSTU04 BU0EVO2-C250	1500 V DC	1x Steckverbinder, 1x offen	1x Buchse	1x MC4-Evo 2	2500 mm	3018480250
PV XSTU04 ST0EVO2-C250	1500 V DC	1x Steckverbinder, 1x offen	1x Stift	1x MC4-Evo 2	2500 mm	3018490250





## Emergency power box for Fronius GEN24

Increasingly, homeowners want to be supplied with electricity from their own PV system even in the event of a power cut. The inverter manufacturer Fronius therefore offers the option of supplying consumers in the event of a power cut in its Fronius GEN24 product range. Weidmüller has developed the appropriate emergency power box to connect the necessary loads quickly and safely if required.

Products of the series Fronius GEN24 are connected to the emergency power box from Weidmüller. If there is a failure in the grid, this hybrid inverter recognises this condition and activates the connection to the emergency power box. Now residents can use various consumers such as a refrigerator or charging cables for mobile phones to this box.

It is possible to use the PV electricity from the roof directly or feed it into a battery. At the same time, the electricity from the battery can be used if no solar power is generated. This simple solution does not require a separate disconnection device after the grid connection point to be installed.



<sup>(A)</sup> 1 phase cable <sup>(B)</sup> Emergency power box <sup>(C)</sup> 1 phase cable with plug

### Your advantages

- Suitable solution for models in the Fronius Hybrid GEN24 and GEN24 Plus series
- Quick and easy installation
- Accessories already included

### Emergency power box

Type	Connection cable	Electrical socket	Order No.
PVC AC NOTSTROMBOX TYPE F CEE 7/3	1 phase cable to connect to the string inveter	Type F CEE 7/3 Electrical socket, Schuko	8000108185
PVC AC NOTSTROMBOX TYPE 23	1 phase cable to connect to the string inveter	Type 23 Electrical socket	8000101331



# VARITECTOR surge protection for all kind of photovoltaic systems

## Lean design and latest technology guarantee best plant protection

**B**



Modern photovoltaic energy generation is streamlined to efficiency. Reliable surge protection with future-proof performance is a must to maximise system uptime and profitability. The VARITECTOR PU PV series is designed for use in PV string combiner boxes for generator voltages up to 1,500 V and complies with latest UL and EN standards for global application.

**600 V  
1.000 V  
1.500 V**

**Type I and II protection**

Type I and II protection is supported for 600V, 1,000V and 1,500V systems fully compliant to latest EN / IEC standards.

**I<sub>scpv</sub>  
11 kA**

**Maximum short-circuit capability**

PV plants, which combine many panels in a string, are efficiently protected up to 11 kA of the prospective short-circuit current. Additional fuses for the SPD are not required.

**Pluggable inserts**



**Pluggable arresters**

The surge protection devices are easily pluggable and enable a tool-free, fast and cost-effective replacement.

**up to  
4,000 m**

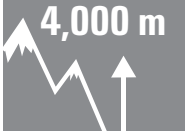

**Safe operation up to 4,000 m**

PV plants, also such located in high altitude regions, are reliably protected. An additional risk analysis of deratings is not required for extraordinary locations.



Visit our website for more information  
[www.weidmueller.com/varitector](http://www.weidmueller.com/varitector)





## Customise your protection with VARITECTOR PU devices A full scale portfolio for tailored DC and AC protection solutions

Several aspects need to be covered that are related to the type of system (e.g. rooftop systems or utility-scale open space systems). When selecting overvoltage protection measures, a set of regulations have to be observed.

### PV systems with external lightning protection

Type II surge protection can be used, provided the separation distance is maintained (usually > 0.7 m to 1 m). If the separation distance is not maintained, a surge protection Type I for DC cabling is required.

### PV systems without external lightning protection

This is a common design for which surge protection Type II must be provided for DC cabling.



The right combiner box for your inverter type in just three steps.  
Find out more on page B.8.

## DC surge arrester

### DC protection for 600 V applications

Type	Type	Version	MPP	Discharge current $I_{imp} / I_{max}$	Qty.	Order No.
VPU PV I+II 3 600 E	I + II	without remote signalling contact	1 MPP	6,25 kA / 40 kA	1	2857030000
VPU PV I+II 3 R 600 E	I + II	with remote signalling contact	1 MPP	6,25 kA / 40 kA	1	2857040000
VPU PV II 3 600	II	without remote signalling contact	1 MPP	- / 50 kA	1	2857060000
VPU PV II 3 R 600	II	with remote signalling contact	1 MPP	- / 50 kA	1	2857070000



### DC protection for 1000 V applications

Type	Type	Version	MPP	Discharge current $I_{imp} / I_{max}$	Qty.	Order No.
VPU PV I+II 3 1000	I + II	without remote signalling contact	1 MPP	6,25 kA / 40 kA	1	2530610000
VPU PV I+II 3 R 1000	I + II	with remote signalling contact	1 MPP	6,25 kA / 40 kA	1	2530620000
VPU PV I+II 5 1000	I + II	without remote signalling contact	2 MPP	5 kA / 40 kA	1	2856440000
VPU PV I+II 5 R 1000	I + II	with remote signalling contact	2 MPP	5 kA / 40 kA	1	2856490000
VPU PV II 3 1000	II	without remote signalling contact	1 MPP	- / 40 kA	1	2530550000
VPU PV II 3 R 1000	II	with remote signalling contact	1 MPP	- / 40 kA	1	2530180000
VPU PV II 5 1000	II	without remote signalling contact	2 MPP	- / 40 kA	1	2856500000
VPU PV II 5 R 1000	II	with remote signalling contact	2 MPP	- / 40 kA	1	2857020000



### DC protection for 1500 V applications

Type	Type	Version	MPP	Discharge current $I_{imp} / I_{max}$	Qty.	Order No.
VPU PV I+II 3 1500	I + II	without remote signalling contact	1 MPP	5 kA / 30 kA	1	2530580000
VPU PV I+II 3 R 1500	I + II	with remote signalling contact	1 MPP	5 kA / 30 kA	1	2530590000
VPU PV II 3 1500	II	without remote signalling contact	1 MPP	- / 30 kA	1	2530640000
VPU PV II 3 R 1500	II	with remote signalling contact	1 MPP	- / 30 kA	1	2530650000



### Arresters for printed circuit boards

Type	Type	Version	Rated voltage $U_c$	Discharge current $I_{imp} / I_{max}$	Qty.	Order No.
VPCB PV I+II R 600 E	I + II	with remote signalling contact	600 V	6,25 kA / 40 kA	1	2857100000
VPCB PV I+II 1000	I + II	without remote signalling contact	1100 V	6,25 kA / 40 kA	1	2665740000
VPCB PV I+II M 1000	I + II	without remote signalling contact	1100 V	6,25 kA / 40 kA	1	2665750000
VPCB PV I+II R 1000	I + II	with remote signalling contact	1100 V	6,25 kA / 40 kA	1	2665760000
VPCB PV I+II R M 1000	I + II	with remote signalling contact	1100 V	6,25 kA / 40 kA	1	2665770000
VPCB PV II R 600	II	with remote signalling contact	600 V	- / 40 kA	1	2857090000
VPCB PV II 1000	II	without remote signalling contact	1100 V	- / 40 kA	1	2665680000
VPCB PV II R 1000	II	with remote signalling contact	1100 V	- / 40 kA	1	2665690000





## AC surge arresters

### AC protection Type I/II for 400 V applications

Type	Continuous current / lightning impulse current ( $I_{imp}$ )	Version	Network	Qty.	Order No.
<b>Type I arrester - pre-counter range - 275 V AC / 25 kA - S-line</b>					
VPU AC I 3 275/25 LCF S	275 V AC / 25 kA	without remote signalling contact, leakage current free	TN-C	1	2726740000
VPU AC I 3 R 275/25 LCF S	275 V AC / 25 kA	with remote signalling contact, leakage current free	TN-C	1	2726750000
VPU AC I 3+1 275/25 LCF S 2PE	275 V AC / 25 kA	without remote signalling contact, leakage current free	TN-C-S, TN-S, TT	1	2726760000
VPU AC I 3+1 R 275/25 LCF S 2PE	275 V AC / 25 kA	with remote signalling contact, leakage current free	TN-C-S, TN-S, TT	1	2726770000
VPU AC I 4 275/25 LCF S	275 V AC / 25 kA	without remote signalling contact, leakage current free	TN-C-S, TN-S	1	2726780000
VPU AC I 4 R 275/25 LCF S	275 V AC / 25 kA	with remote signalling contact, leakage current free	TN-C-S, TN-S	1	2726790000
<b>Type I arrester - pre-counter range - 300 V AC / 12.5 kA</b>					
VPU AC I 3 300/12.5 LCF	300 V AC / 12.5 kA	without remote signalling contact, leakage current free	TN-C	1	2636970000
VPU AC I 3 R 300/12.5 LCF	300 V AC / 12.5 kA	with remote signalling contact, leakage current free	TN-C	1	2636980000
VPU AC I 3+1 300/12.5 LCF	300 V AC / 12.5 kA	without remote signalling contact, leakage current free	TN-C-S, TN-S, TT	1	2636910000
VPU AC I 3+1 R 300/12.5 LCF	300 V AC / 12.5 kA	with remote signalling contact, leakage current free	TN-C-S, TN-S, TT	1	2636920000
<b>Type I arrester - post-counter range - 300 V AC / 12.5 kA</b>					
VPU AC I 3 300/12.5	300 V AC / 12.5 kA	without remote signalling contact	TN-C	1	2591440000
VPU AC I 3 R 300/12.5	300 V AC / 12.5 kA	with remote signalling contact	TN-C	1	2591450000
VPU AC I 3+1 300/12.5	300 V AC / 12.5 kA	without remote signalling contact	TN-C-S, TT, IT with N, IT without N	1	2591460000
VPU AC I 3+1 R 300/12.5	300 V AC / 12.5 kA	with remote signalling contact	TN-C-S, TT, IT with N, IT without N	1	2591470000
VPU AC I 4 300/12.5	300 V AC / 12.5 kA	without remote signalling contact	TN-C-S, TN-S	1	2591420000
VPU AC I 4 R 300/12.5	300 V AC / 12.5 kA	with remote signalling contact	TN-C-S, TN-S	1	2591430000



### AC protection Type I/II for 400 V / 40 mm busbar

Type	Continuous current / lightning impulse current ( $I_{imp}$ )	Version	Network	Qty.	Order No.
<b>12.5 kA - without phase tap</b>					
VPU ZPA S I 3 300/12,5	300 V AC / 12.5 kA	without remote signalling contact, leakage current free	TN-C	1	2830870000
VPU ZPA S I 3+1 300/12,5	300 V AC / 12.5 kA	without remote signalling contact, leakage current free	TN-S, TT, IT	1	2830900000
<b>12.5 kA - with phase tap for L1</b>					
VPU ZPA S I 3+1 RA 300/12,5	300 V AC / 12.5 kA	with remote signalling contact, leakage current free	TN-S, TT, IT	1	2830920000
<b>7.5 kA - without phase tap</b>					
VPU ZPA S I 3 300/7,5	300 V AC / 7.5 kA	without remote signalling contact, leakage current free	TN-C	1	2830930000
VPU ZPA S I 3+1 300/7,5	300 V AC / 7.5 kA	without remote signalling contact, leakage current free	TN-S, TT, IT	1	2830960000
<b>7.5 kA - with phase tap for L1</b>					
VPU ZPA S I 3+1 RA 300/7,5	300 V AC / 7.5 kA	with remote signalling contact, leakage current free	TN-S, TT, IT	1	2830980000



### AC protection Type II for 400 V applications

Type	Continuous current / lightning impulse current ( $I_{imp}$ )	Version	Network	Qty.	Order No.
<b>Type I arrester - post-counter range - 300 V AC / 12.5 kA</b>					
VPU AC II 3 300/50	300 V AC / 50 kA	without remote signalling contact	TN-C	1	2591160000
VPU AC II 3 R 300/50	300 V AC / 50 kA	with remote signalling contact	TN-C	1	2591170000
VPU AC II 3+1 300/50	300 V AC / 50 kA	without remote signalling contact	TN-C-S, TN-S, TT, IT	1	2591080000
VPU AC II 3+1 R 300/50	300 V AC / 50 kA	with remote signalling contact	TN-C-S, TN-S, TT, IT	1	2591090000
VPU AC II 4 300/50	300 V AC / 50 kA	without remote signalling contact	TN-C-S, TN-S	1	2591140000
VPU AC II 4 R 300/50	300 V AC / 50 kA	with remote signalling contact	TN-C-S, TN-S	1	2591150000
<b>Type II arrester with integrated fuse - post-counter range - 300 V AC / 50 kA</b>					
VPU AC II F 3 300/40	300 V AC / 50 kA	without remote signalling contact	TN-C	1	2827600000
VPU AC II F 3 R 300/40	300 V AC / 50 kA	with remote signalling contact	TN-C	1	2807410000
VPU AC II F 3+1 300/40	300 V AC / 50 kA	without remote signalling contact	TN-C-S, TN-S, TT, IT	1	2827630000
VPU AC II F 3+1 R 300/40	300 V AC / 50 kA	with remote signalling contact	TN-C-S, TN-S, TT, IT	1	2807440000
VPU AC II F 4 300/40	300 V AC / 50 kA	without remote signalling contact	TN-C-S, TN-S	1	2827610000
VPU AC II F 4 R 300/40	300 V AC / 50 kA	with remote signalling contact	TN-C-S, TN-S	1	2807420000



**AC protection Type I/II for 800 V applications**

Type	Continuous current / lightning impulse current ( $I_{imp}$ )	Version	Network	Qty.	Order No.
VPU AC I 3+MOV R 950/12.5	950 V AC / 50 kA	with remote signalling contact	TN-C, IT without N	1	2845570000

**V-DATA - Data protection arrester**

Type	Suitable for:	Connection	Qty.	Order No.
VDATA CAT6	Cat. 5 (up to 100 MHz) and Cat. 6 to 250 MHz (Class E), PoE (according to IEEE 802.3af) and PoE+ (according to IEEE 802.3at)	RJ45	1	1348590000

**Recommendation**

As PV systems are generally installed in unprotected environments (danger from direct lightning strikes), it is generally advisable to install type I+II surge protection. This also increases the service life of the protectionprotective components used.



You can find more information about our accessories and other articles on our website:

[www.weidmuller.com/varitector\\_pv\\_solutions](http://www.weidmuller.com/varitector_pv_solutions)



# Maximum yield with dynamic solar islands

## Successful project with Floating Solar BV for solar islands that rotate with the sun

**B**



Technology in the photovoltaic energy sector has been developing very fast in recent years. Thanks to the focus on renewable energy sources and cost optimisation, the installed capacity of PV systems in every country is increasing rapidly. Floating solar energy systems contribute to this goal. The characteristics of infrastructure in the Netherlands make this technique very applicable for the development of solar power systems. The aim is to increase the percentage of renewable energy used as part of the „European Green Deal“ and the „Paris Climate Agreement“.



The company Floating Solar BV, based in the Netherlands, specialises in floating solar power systems. They have established three artificial islands for the largest floating, dynamic solar park in Europe. The plan is to extend this to 15 islands. The solar park will soon contain 67,000 solar panels which will be divided across 15 round islands, each 140 meters in diameter. These panels float in a basin where water is stored for later use. Together, they will have a capacity of over 22 MW peak.

The solar panels installed by Floating Solar add a new function to the water basin. They remain cooler, rotate with the sun, and produce more than standard panels. This increases the output power, decreases the cost of energy production, and significantly improves the ROI. One of the islands (4,500 panels) will be equipped with sensors that permanently monitor the water quality for algae formation, light penetration, and ecology, for example. The next islands will only be built when it appears there are no significant negative side effects on nature and the water quality.





Floating Solar BV is a company that delivers high quality systems. Partly thanks to their mother company Dromec (specialised in offshore winch installations) they have developed this unique concept of solar islands that rotate with the sun. Their specific needs made them look for partners who have the quality products and knowledge for this application. In Weidmüller they have found a partner who supports them in design, logistical challenges, commissioning and the final delivery. Extra attention is paid to the relevant documents and quality approvals. It was also important to them that the working method and people involved in the projects fit the culture and objectives of Floating Solar.

General Manager at Floating Solar BV, Kees-Jan van der Geer; „We have made strategic decisions to achieve and secure the culture of quality and solution orientation. Weidmüller fits this approach with regard to the price-quality ratio and the support they provide. They have delivered a tailor-made solution for connecting and

securing the DC circuit in solar power systems. Our customers have very high demands regarding quality, quality marks, documentation, method of drawing, schedule delivery, test procedures and so on.“  
„Even when choosing the right data cabling and connectors, for example, Weidmüller provided its service, even instructing the technicians on-site so they could assemble and test these with the right tools“ – Ralph van Dijk, Manager of Operations at Floating Solar. The environmental conditions are harsh and the intended lifespan long. The entire design of the islands is focused on this. They even take into account unharmed bird deterrent so that the surface of the panels remains clean.

The combiner boxes also have to meet the highest standards, from the entrance of the string cables to the thick power outputs, every little detail has been taken into account to ensure the right performance for the whole system. The Floating Combiner Boxes contain the overcurrent and overvoltage protection devices on the DC

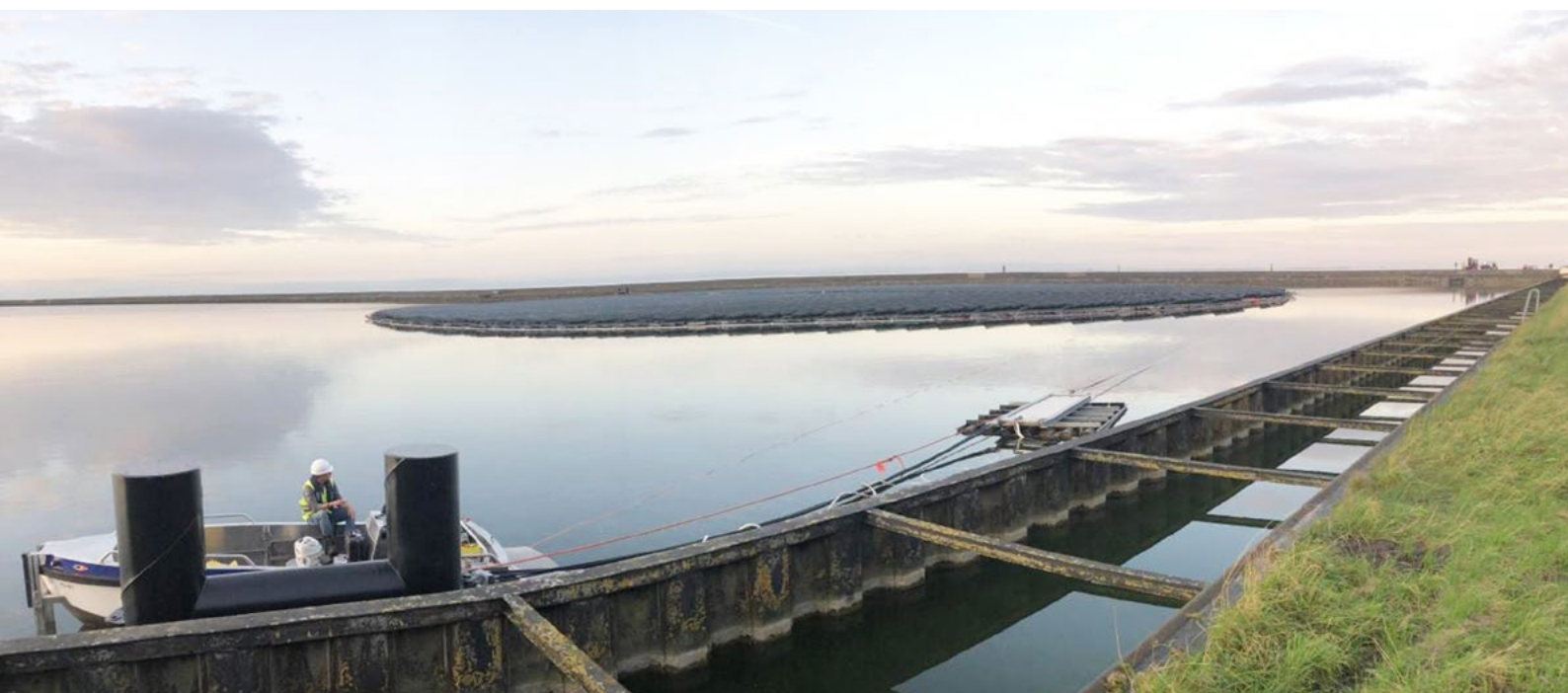

B



side of the system. This is where all the generated power goes through the system, so it is extremely important to ensure performance in terms of protection and reliability.

To develop the most optimised solution we considered electrical safety conditions, types of cables glands, connectors, and the material of terminals as well as their temperature and humidity behaviour. The Weidmüller range of combiner boxes for floating systems are designed and tested for these conditions. Quality checks are carried out on each individual box and other critical components before they are taken into the production line. Once the combiner box is ready,

just before packaging, Weidmüller's specialists check and verify it on key components which affect the IP classification. All this makes it possible to achieve a high level of quality, giving the system's investor a reliable set of products.

Finally, very tight delivery times have to be met in order to meet the project deadlines and ensure that the system can deliver energy to the public grid on time. The close cooperation between Floating Solar BV and Weidmüller has contributed to the success in achieving the targets. Weidmüller supplies customised solutions for connecting and securing the DC circuit in solar power plants.





# Proven competence

## Reference projects around the globe

### B

The best proof of the quality of our solutions is their worldwide use. More than 250,000 of our photovoltaic combiner boxes are installed in over 100 countries worldwide. They connect 120 million photovoltaic modules. Our reference project database provides an overview.



#### Floating dynamic solar park

Dynamic solar islands

-  Location: Andijk, Netherlandse
-  Performance: 22 MWp
-  Start-up: 2021
-  Solution: 21 PV Floating DC Combiner Boxes



#### Suria Sungai Petani

PV Utility Park

-  Location: Kuala Muda, Malaysia
-  Performance: 116 MW
-  Start-up: 2021
-  Solution: 437 DC Combiner Boxes



#### Droogfontein





PV Utility Park

-  Location: South Africa
-  Performance: 80 MWp
-  Start-up: 2019
-  Solution: 450 Combiner Boxes



#### Sol do Sertão

PV Utility Park

-  Location: Oliveira dos Brejinhos, Brazil
-  Performance: 474 MWp
-  Start-up: 2021
-  Solution: 2,318 DC Combiner Boxes



Discover more reference projects on our website:  
[www.weidmueller.com/pv-references](http://www.weidmueller.com/pv-references)

## Tested quality

### Standard tests and services guaranteeing a long service life

#### Trust in approved quality

Our laboratory is accredited according to international standards. It operates independently and is recognised by institutions, registration services, and other institutions and authorities. As a member of the CTD program, Weidmüller is regularly audited by UL, especially about test methods, quality management and documentation.

All combiner boxes are tested according to IEC-61439-ed-2 and are constructed on the basis of the test results as well as assembled for the specific application. This ensures that each of the requirements of the target application is fully met.

#### Your benefits at a glance

- 5 years warranty
- Laboratory testing
- Commissioning Services
- On-Site Inspection

B

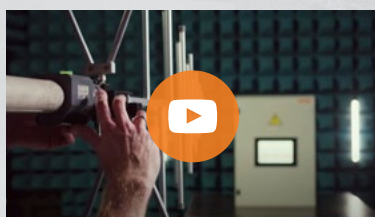

#### Tested & proven

Our PV boxes are designed and tested to withstand extreme climate fluctuations. See for yourself in our video straight from our lab.





# Energy storage

<b>Energy storage</b>	Introduction	C.2
	Products, solutions and services for battery energy storage systems	C.6
	Energy Management System (EMS)	C.8
	Battery storage systems (racks and modules)	C.10
	Battery Management System (BMS)	C.12
	WBC - Battery connector	C.14
	High-performance components	C.32



# Demand-based supply of renewable energy to the grid

## Battery energy storage systems from Weidmüller

C

Renewable energy is the future. However, it cannot be produced at a consistent rate. Powerful energy storage systems are needed to ensure that the required amount of generated energy is available at all times. Alongside generation, utilisation and transmission, they form the fourth pillar of the energy market structure of the future.

Battery energy storage systems (BESS) that see the most widespread use are those that employ conventional accumulators – with lithium-based accumulator systems currently being the predominant storage solution. The generic term “energy storage systems” (ESS) principally encompasses all storage options – including chemical systems, such as hydrogen-powered systems, and mechanical systems like hydropower (see also chapter D – Hydrogen).

Weidmüller was quick to recognise the great importance of energy storage systems, developing cross-sector solutions for all market areas – from energy generation using PV and wind power plants to applications in hydrogen technology all the way to various energy storage systems and electromobility. We are the partner for you when it comes to the planning and development of holistically organised storage systems and will supply you with suitable products, components and pre-assembled, customised partial solutions ready for implementation.



For further products, information, technical specifications or additional services, please visit our website:

[www.weidmueller.com/energy-storage](http://www.weidmueller.com/energy-storage)





On the following pages, we will introduce you to a selection of our range of products and solutions for the use of battery energy storage systems.

These include, for example, solutions for the construction of connected storage cells, for efficient battery management (BMS), for power conversion using inverter systems (PCS) and for the construction of intelligent controllers and energy management systems (EMS). We also have suitable products in our programme for the operation of supporting systems, such as air conditioning solutions and fire-fighting systems.

And thanks to end-to-end compatibility with our industrial connectivity and digitalisation solutions, even highly customised systems can be implemented with ease.

As a future-oriented partner, we will assist you with project planning, supply you with individually tailored products and even support you in the development of completely new storage solutions or technologies.

Whatever you have in mind: we are full of energy and ready to help!

## Technologies for Energy Storage

Power
 Heat/Cold
 Fuels/  
Raw-Materials

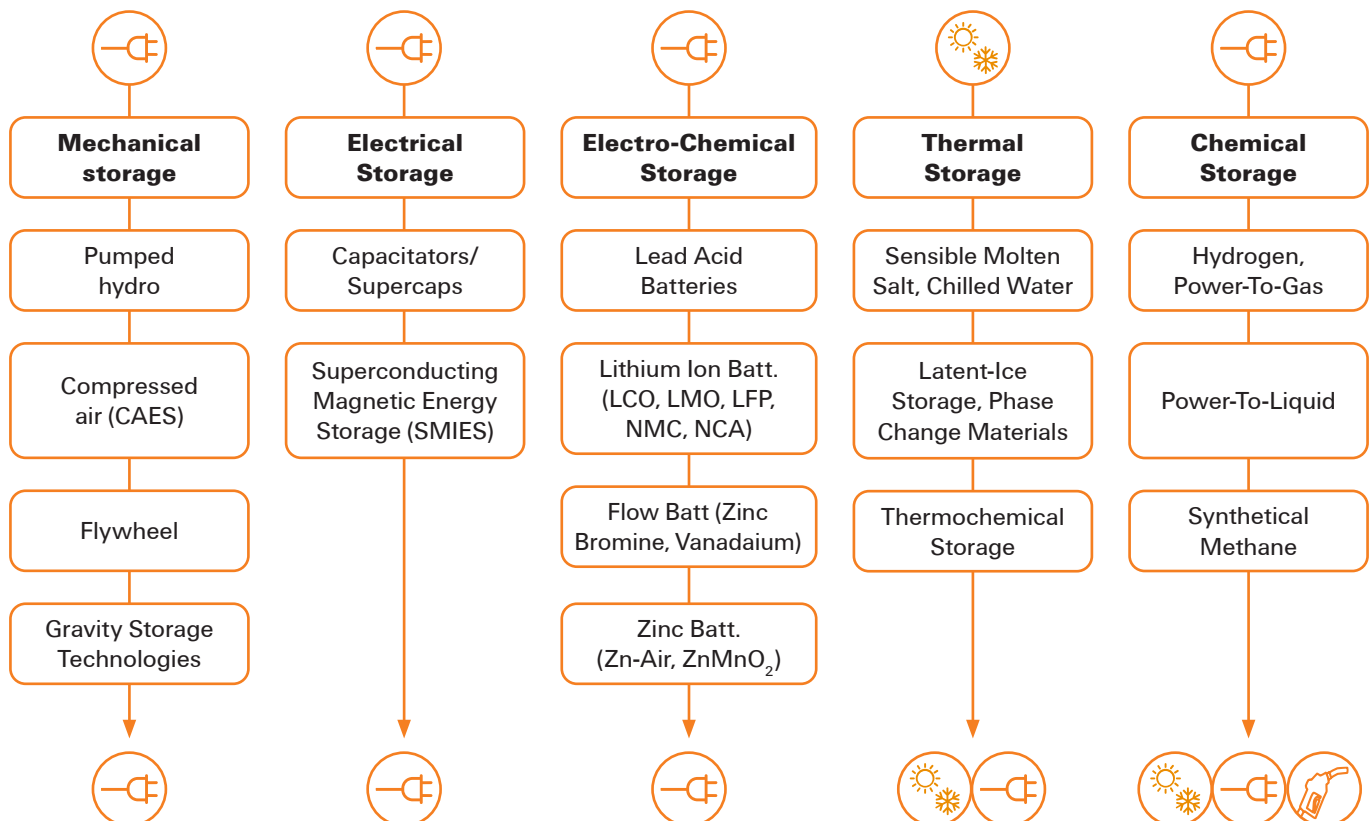

# The most important functional systems in a battery energy storage system (BESS)

C

A battery storage system is made up of various functional subunits, which only form a perfectly functioning unit if they interact perfectly. High-quality components are particularly effective when it comes to maximising the availability of a battery energy storage system and enable cost-effective operation over the entire service life of the system.



## Battery Pack

- Assembly of single battery cells to larger packs and modules
- BMS and/or PLC controlled

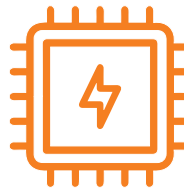

## Energy Management System (EMS)

- The EMS is responsible for the monitoring and control of the energy flow within the BESS
- The EMS coordinates the BMS, PCS and other assisting systems; by collection and analysing the energy data it manages the resources of the system



## Battery Management System (BMS)

- Monitors the condition of the cells
- Measures of the parameters and states e.g. SOC, SOH, temperature, etc.
- Battery balancing

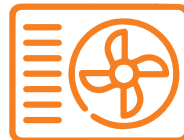

## HVAC

- Ensures the correct heat dissipation and environmental conditioning around the cells/modules



## Inverter (PCS)

- DC/AC or DC/DC transformation
- Bi-directional system for charge and discharging of the BESS



## Fire-Control

- First attempt system for fire extinguishing in case of thermal runaway and fire.



**ENERGY SOURCES**

**BESS APPLICATIONS**

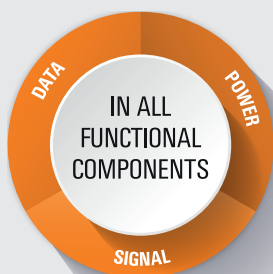
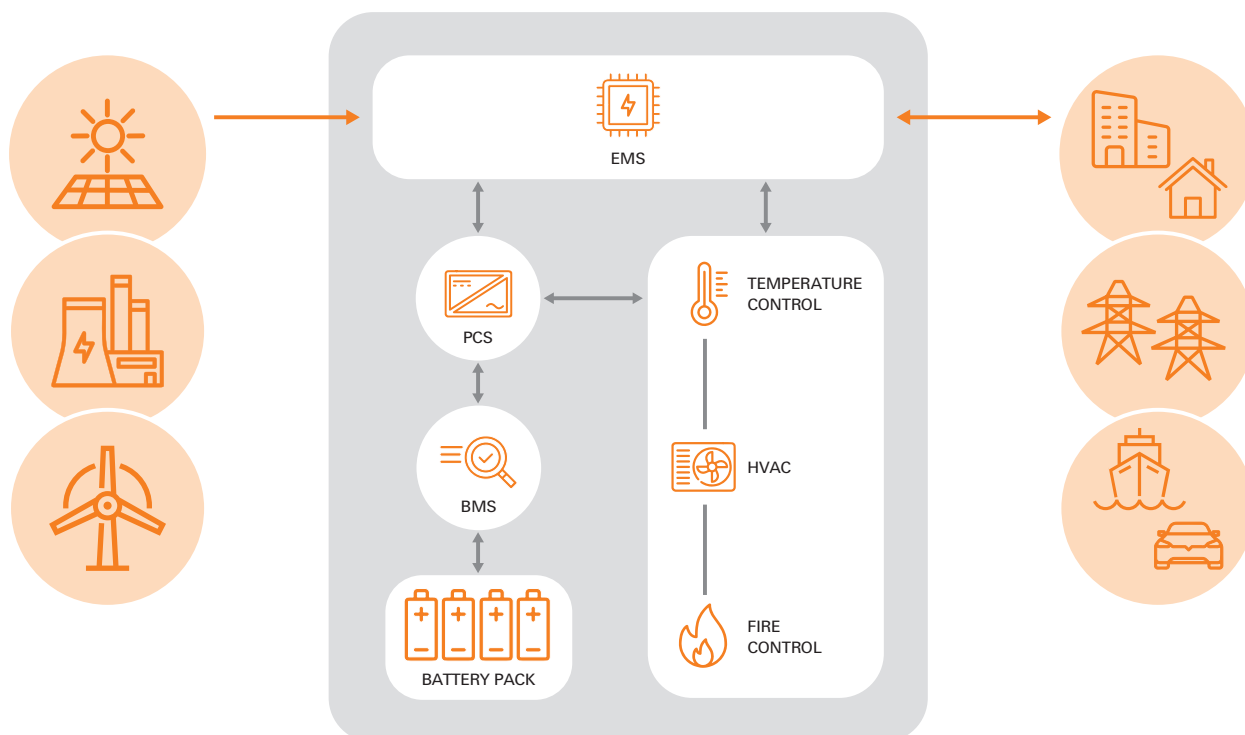

Various currents are handled in a battery energy storage system. Firstly, current is stored and withdrawn.

In addition, a lot of data is generated and required for control when monitoring and controlling the storage processes, and this data must be handled in a secure and reliable manner. Of course, the data must also be handled reliably over long distances and possibly also via radio or cloud.

In addition, it must be possible to securely record, convert and analyse a large variety of signals in a storage system.

Weidmüller offers answers for all these tasks with its extensive portfolio of products and solutions for the battery energy storage sector.

# Our products, solutions and services for battery energy storage systems

## Application fields for BESS

### C



**HVAC**  
(Heating, Ventilation,  
Air-Conditioning)

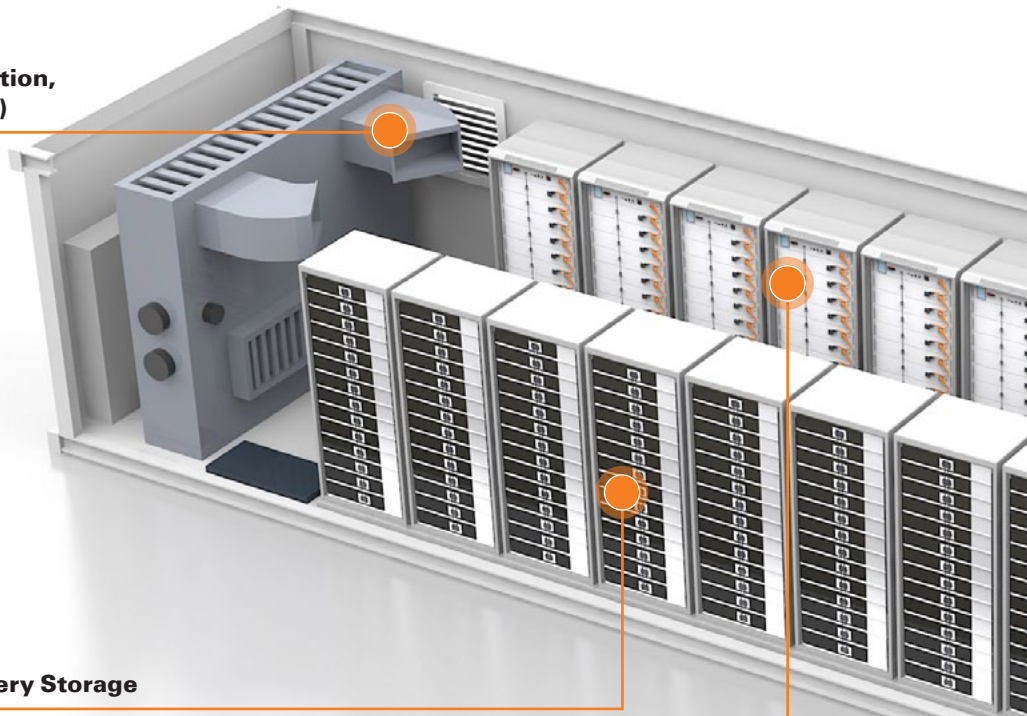

**Battery Storage**



**Batterie-Management-System (BMS)**

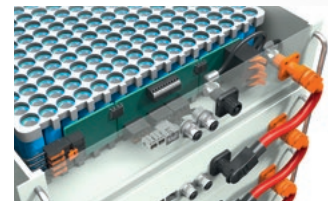

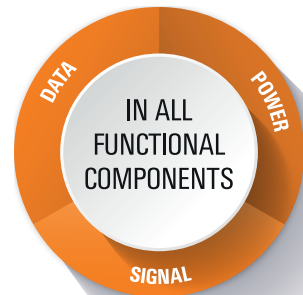

**Fire-Control**

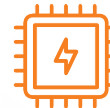

**Energy Management System (EMS)**

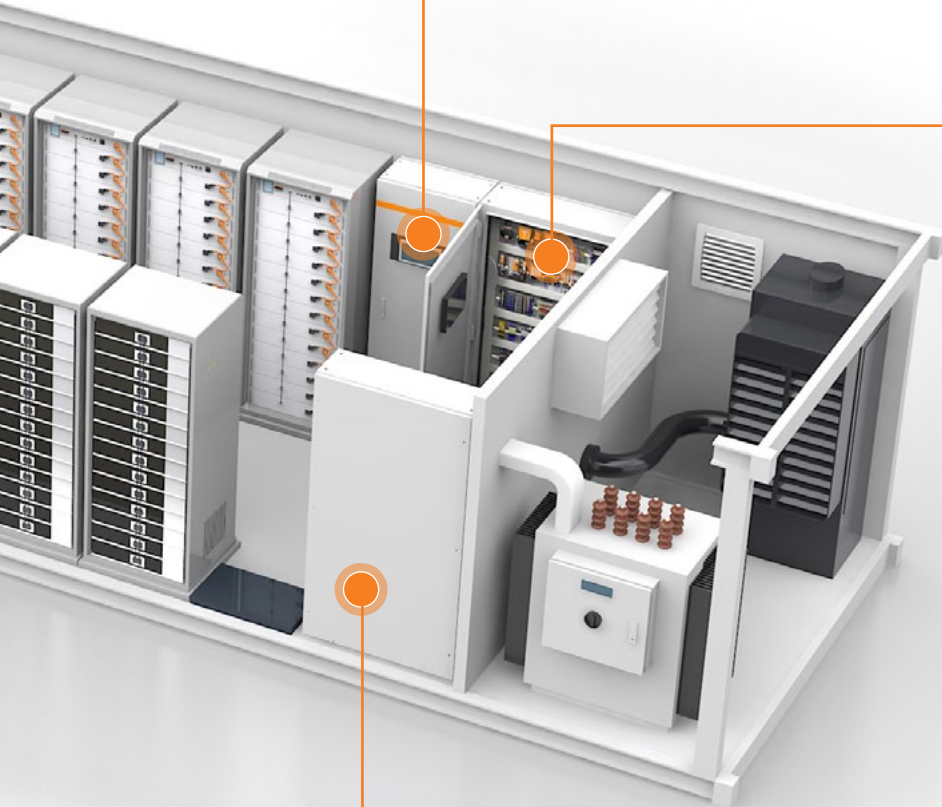

**Inverter (PCS)**



# Our products, solutions and services for battery energy storage systems

## Product fields for BESS

Weidmüller offers various products and solutions suitable for battery energy storage solutions (BESS). Discover our range of connectivity, electronic and automation solutions for your battery energy storage system.

C



### Power supplies

Power supplies and auxiliary components suitable for industrial applications – from primary switched-mode power supplies to DC/DC converters and UPS control modules to electronic fuses.

### Automation and software

Optimise your automation processes – Easy and IoT ready

### Relais

Switch to simple – with Klippon® Relay  
High-quality relay with unique all-around service  
Whether switching, isolating, amplifying or multiplying: relays perform a wide range of different tasks in industrial applications.

### VARITECTOR lightning and surge protection

Lightning and surge protection devices that conform to the standards of DIN VDE 0100-443 and -534 for mandatory surge protection in building infrastructures.

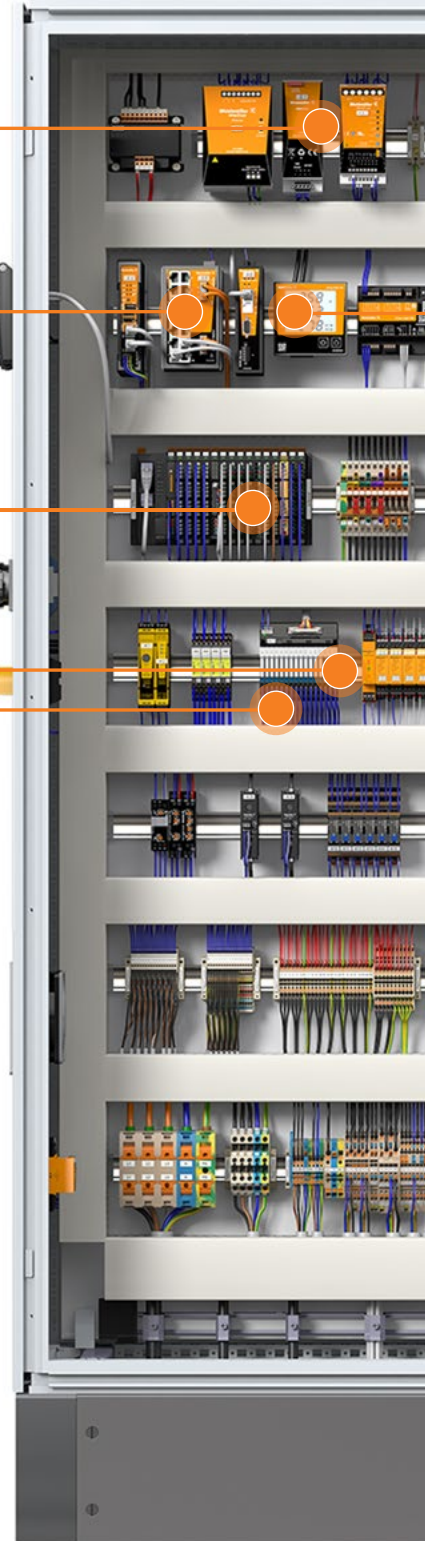

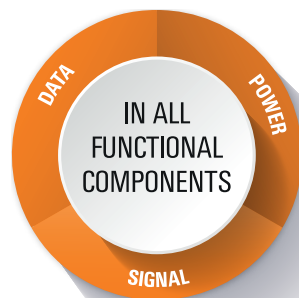

### Measuring and monitoring systems

Energy management solutions for smart machines, factories and grids

### Media converters and protocol gateways

Our media converters and protocol gateways ensure smooth communication between all network participants and are also especially convenient and economical.

### RockStar® heavy-duty connectors

RockStar® heavy-duty connectors ensure the safe and reliable transmission of power, signals and data in industrial environments, both inside the control cabinet and outside in the field.

### Klippon® Connect terminal block connectivity

Specially developed installation terminal blocks for the unique requirements and safety specifications of wiring in buildings.

### Workshop & Accessories

Practical advantages for optimised work processes. Professional tools, printing solutions, markers, industrial luminaires and accessories for the highest demands.



# Connection and communication solutions for battery energy storage system

## Versatile solutions for a secure and reliable connection for energy, data and signals

C

Our high-quality Weidmüller components play a crucial role in the secure connection of all individual cells to battery packs and modules. As a result, we ensure not only the smooth functioning, but also the high availability of battery energy storage systems (BESS). In addition, our components enable safe monitoring and communication between the cells, the battery management system (BMS) and the energy management system (EMS). With Weidmüller, you are on the safe side.

### OMNIMATE® Power printed circuit board terminals

The sturdy, direct connection for extreme current and voltage requirements in all power electronics applications.

- Top performance up to 150 A / 1000 V (IEC) and 127 A / 600 V (UL)
- Application-specific scalability with connection cross-sections from 16 mm<sup>2</sup> to 50 mm<sup>2</sup>



### OMNIMATE® Data RJ45 sockets

The future-proof transmission solution in the industrial environment.

- Compatible with RJ45 connectors acc. to ANSI / TIA-1096-A and IEC 60603
- Extended temperature range of -40°C to +85°C for maximum performance
- Reinforced gold layer (30 µm) for improved corrosion protection



**OMNIMATE® 4.0 product range**

- Compact printed circuit board terminals and plug-in connectors for fast signal connections
- Innovative SNAP IN connection technology for extremely fast wiring
- Ideal for fully automated wiring processes (ready-to-robot)
- Custom configuration in the web configurator for maximum flexibility

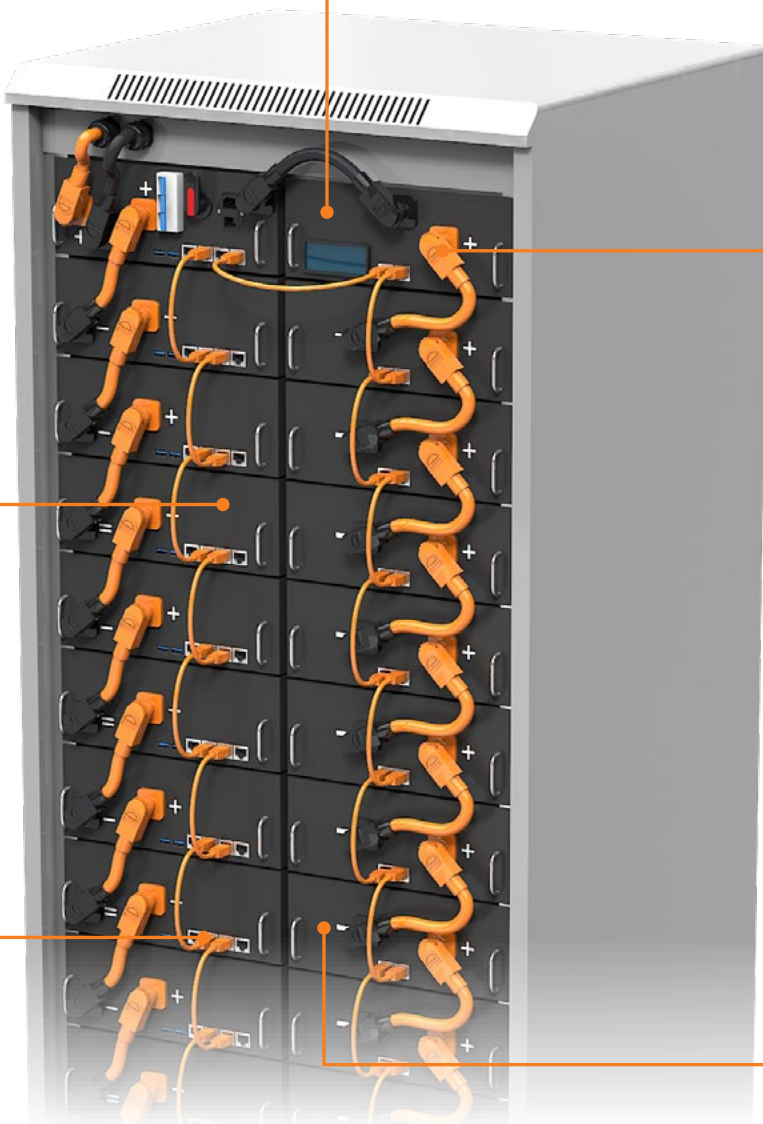

**Battery connectors**

Reliable connections for battery poles. The central connection elements for storage systems. Safe and flexible wire connectors for battery poles.



**Serial signal protection such as RS 485 / RS 422**

Under the protection of the data protection RS 485 come the following signals:

- Protection for wire-connected serial data transmission – RS 485 or RS 422
- Pluggable arrester, with no-interrupt and impedance-neutral plug-in and pull-out
- Low residual voltage
- Can be used in accordance with IEC 62305 and IEC 61643-22 installation standards
- Can be tested with the V-TEST testing device
- Integrated PE foot, safely discharges up to 20 kA (8/20  $\mu$ s) and 2.5 kA (10/350  $\mu$ s) to PE



# Connection solutions for battery packs, modules and BMS boards

## A variety of solutions for connecting the BMS and battery cells

The BMS relies on a network of connections to ensure its dependable performance. It efficiently manages the quantity of individual battery cells linked to temperature and energy metrics, contingent on secure connections and accurate data from the Energy Management System (EMS). To accommodate diverse input streams related to power, communication types, and signals, a variety of reliable and space-saving connectors is imperative. Weidmüller offers a comprehensive selection, particularly excelling in PCB-board connectors within the OMNIMATE® range. These connectors are suitable for almost every conceivable connection problem and offer robust and suitable solutions for optimum BMS functionality.

**OMNIMATE® Signal Board-to-Board-solutions**  
OMNIMATE® Signal - BtB connectors feature a 1.27 mm pitch, offering maximum flexibility in design. With industry-compatible packing density and versatile connection options (mezzanine, mother-to-daughter, board-to-board), these connectors ensure contact reliability with up to 500 mating cycles due to an industrial-grade gold surface (PdNi-Au) and process reliability with high-temperature LCP material suitable for reflow soldering.



### OMNIMATE® 4.0 - Power connectors

OMNIMATE® 4.0 - Power connectors feature a modular design facilitating swift customization of individual interfaces. These compact PCB connectors cater to power electronics up to 1,000 V, ensuring rapid and tool-free wiring through innovative SNAP IN connection technology.



**OMNIMATE® Signal - LSF-SMT PCB terminal blocks PUSH IN**

OMNIMATE® Signal - LSF-SMT PCB terminal blocks with PUSH IN technology offer an innovative, quick, and cost-effective solution. Featuring a spring connection in direct plug-in technology, it simplifies connection processes without tools. Ideal for solid cores or conductors with ferrules, it allows tool-free connect and disconnect. The reflow or vapor phase process enables automatic processing, with potentials and clamping points clearly marked by colored push buttons.



**Battery connectors**

Reliable connections for battery poles. The central connection elements for storage systems. Safe and flexible wire connectors for battery poles.

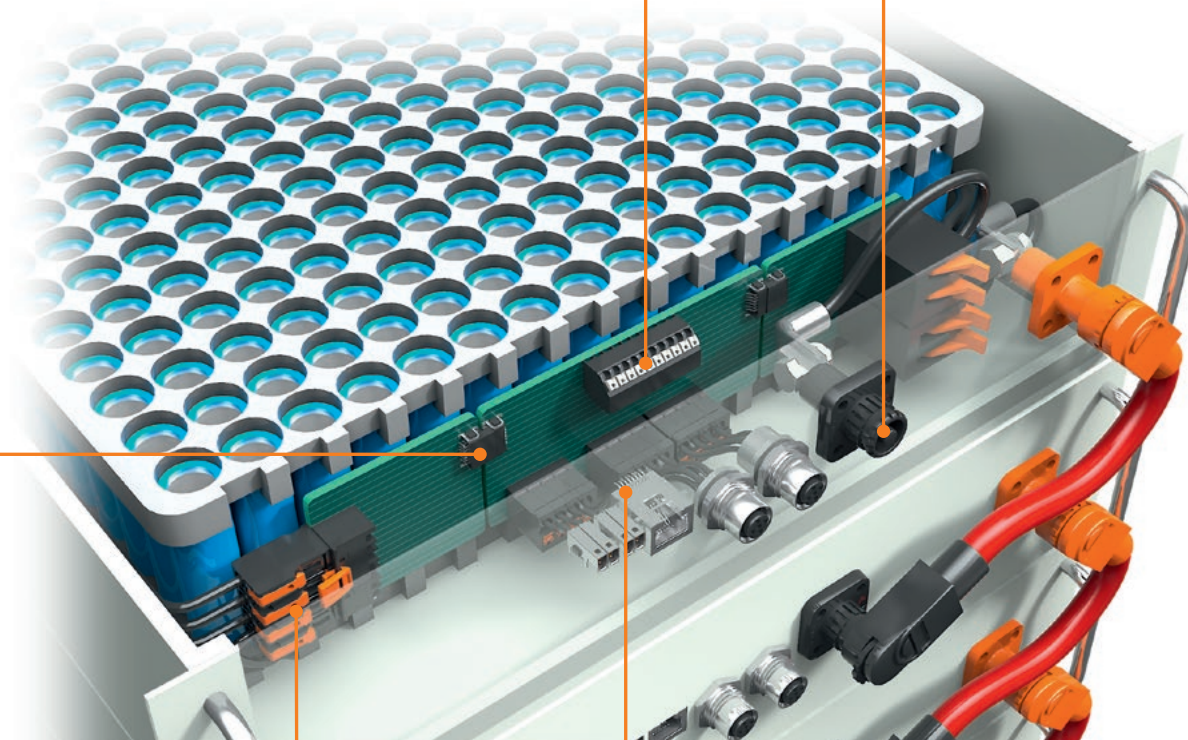

**Single Pair Ethernet**

As industrial plants digitize, traditional Ethernet for sensors and control units falls short. Weidmüller pioneers Single Pair Ethernet technology, a cost-effective solution for connecting numerous Industrial IoT devices seamlessly, from field sensors to the cloud, establishing new industry standards.



# Connect individual battery packs to form a battery energy storage system (BESS)

## Battery pole connector in IP67

Battery energy storage systems are playing an increasingly important role in the field of renewable energies. They usually consist of several individual batteries that need to be quick and easy to replace.

The Weidmüller battery connector (WBC) makes it easy to connect several individual batteries to form a battery energy storage system and allows them to be disconnected just as easily if necessary. Whether in small storage systems for home use or in large battery containers - the WBC covers a wide range of applications.





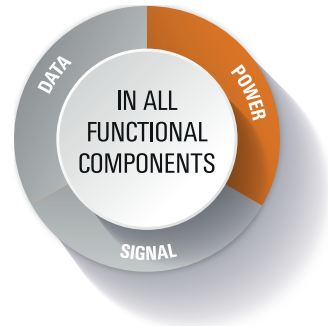

The Weidmüller battery connector (WBC) enables the connection of conductor cross-sections ranging from 16 mm<sup>2</sup> to 95 mm<sup>2</sup> on the connector side. The counterpart of the plug has a busbar to which the conductor can be easily attached on the device side using a cable lug. This design ensures a simple and efficient connection that covers a wide range of conductor cross-sections and simplifies handling on the device side.

### Your special advantages:

- User-friendly design that enables effortless handling
- Reliable locking mechanism that ensures a secure and stable connection between the individual batteries
- Unique plug coding ensures reverse polarity protection, minimises the risk of incorrect connections and protects against damage caused by incorrect polarity
- Safe to touch due to protected mounting side
- Protection class IP 67: protected against the infiltration of dust and water
- Complies with the requirements of UL standard 4128 and therefore fulfils international safety standards



### Product selection table

		Rated current	Conductor cross section	Rated voltage	
		100 A	16 mm <sup>2</sup>	1500 V	
		120 A	25 mm <sup>2</sup>		
		180 A	35 mm <sup>2</sup>		
		200 A	50 mm <sup>2</sup>	1500 V	
		250 A	70 mm <sup>2</sup>		
		250 A	70 mm <sup>2</sup>	1500 V	
		350 A	95 mm <sup>2</sup>		
		120 A	25 mm <sup>2</sup>	1500 V	
		350 A	95 mm <sup>2</sup>		

**Reverse polarity protection**

Due to the simple integrated plug coding, negative and positive plugs cannot be plugged in incorrectly.

**Touch-proof**

The mounting side is designed to be safe to touch. So there is no danger to life and limb even if the plug is missing.

**Non-twisting**

The fine-linked grid offers plenty of flexibility and at the same time ensures that the plug is firmly seated. This ensures a uniform design when wiring.

100 A...120 A - Minus connector

WBC-P-6BK-16

WBC-P-6BK-25

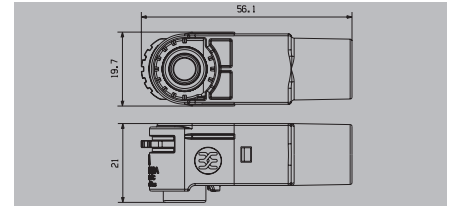
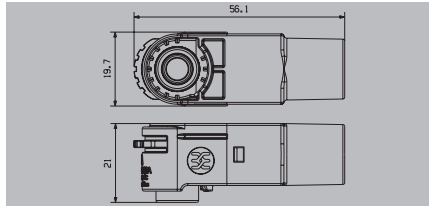

Technical data

Conductor cross-section, max.	16 mm <sup>2</sup>
Rated current	100 A
Outer cable diameter, min. / max.	7.8...8.6 mm
Type of connection	Crimp connection
Colour	black
Contact diameter, male Ø	6 mm
Type	Female
Volume resistance	≥ 5000 MΩ
Rated voltage	1500 V
Plugging cycles	≥ 100
Surface finish	silver
Material	PA 66
UL 94 flammability rating	V-0
Protection degree	IP67 plugged
Weight	23.2 GRM
Length / Width / Depth	56.1 / 19.7 / 21 mm
Approvals	UL 4128
<b>Note</b>	

Conductor cross-section, max.	25 mm <sup>2</sup>
Rated current	120 A
Outer cable diameter, min. / max.	9.8...10.5 mm
Type of connection	Crimp connection
Colour	black
Contact diameter, male Ø	6 mm
Type	Female
Volume resistance	≥ 5000 MΩ
Rated voltage	1500 V
Plugging cycles	≥ 100
Surface finish	silver
Material	PA 66
UL 94 flammability rating	V-0
Protection degree	IP67 plugged
Weight	23.2 GRM
Length / Width / Depth	56.1 / 19.7 / 21 mm
Approvals	UL 4128
<b>Note</b>	

Conductor cross-section, max.	25 mm <sup>2</sup>
Rated current	120 A
Outer cable diameter, min. / max.	9.8...10.5 mm
Type of connection	Crimp connection
Colour	black
Contact diameter, male Ø	6 mm
Type	Female
Volume resistance	≥ 5000 MΩ
Rated voltage	1500 V
Plugging cycles	≥ 100
Surface finish	silver
Material	PA 66
UL 94 flammability rating	V-0
Protection degree	IP67 plugged
Weight	23.2 GRM
Length / Width / Depth	56.1 / 19.7 / 21 mm
Approvals	UL 4128
<b>Note</b>	

Ordering data

<b>Note</b>
-------------

Type	Qty.	Order No.
WBC-P-6BK-16	5	2905270000

Type	Qty.	Order No.
WBC-P-6BK-25	5	2905290000

Accessories

Tools
Pressing tool
Replacement crimp inserts
<b>Note</b>

Type	Qty.	Order No.
EPG 45	1	1500830000
ES EPG 45 DIN 25	1	1501340000

Type	Qty.	Order No.
EPG 45	1	1500830000
ES EPG 45 DIN 25	1	1501340000

100 A...120 A – Minus connector

WBC-S-6BK-B

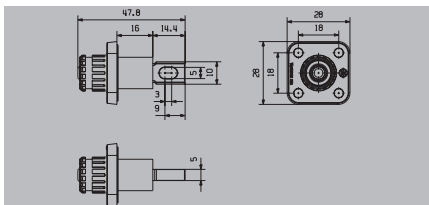

Technical data

Conductor cross-section, max.	25 mm <sup>2</sup>
Rated current	120 A
Type of connection	Screw connection
Colour	black
Contact diameter, male Ø	6 mm
Type	Male
Volume resistance	≥ 5000 MΩ
Rated voltage	1500 V
Plugging cycles	≥ 100
Surface finish	silver
Material	PA 66
UL 94 flammability rating	V-0
Protection degree	IP67 plugged
Weight	23.6 GRM
Length / Width / Depth	28 / 28 / 47.8 mm
Approvals	UL 4128

Note

Ordering data

Type	Qty.	Order No.
WBC-S-6BK-B	5	2905330000

Note

100 A...120 A - Plus connector

WBC-P-60R-16

WBC-P-60R-25

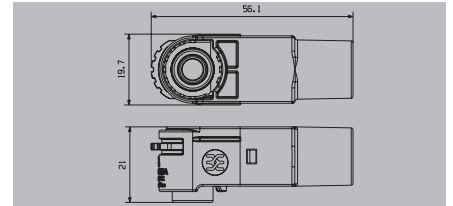
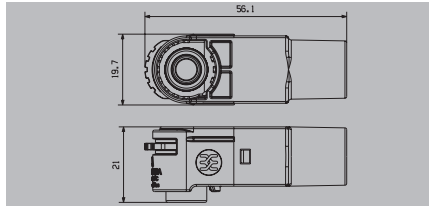

Technical data

Conductor cross-section, max.	16 mm <sup>2</sup>	25 mm <sup>2</sup>
Rated current	100 A	120 A
Outer cable diameter, min. / max.	7.8...8.6 mm	10.5...9.8 mm
Type of connection	Crimp connection	Crimp connection
Colour	orange	orange
Contact diameter, male Ø	6 mm	
Type	Female	Female
Volume resistance	≥ 5000 MΩ	≥ 5000 MΩ
Rated voltage	1500 V	1500 V
Plugging cycles	≥ 100	≥ 100
Surface finish	silver	silver
Material	PA 66	PA 66
UL 94 flammability rating	V-0	V-0
Protection degree	IP67 plugged	IP67 plugged
Weight	23.2 GRM	23.2 GRM
Length / Width / Depth	56.1 / 19.7 / 21 mm	56.1 / 19.7 / 21 mm
Approvals	UL 4128	UL 4128
<b>Note</b>		

Ordering data

Type	Qty.	Order No.	Type	Qty.	Order No.
WBC-P-60R-16	5	2905280000	WBC-P-60R-25	5	2905300000
<b>Note</b>					

Accessories

Tools	Type	Qty.	Order No.	Type	Qty.	Order No.
	EPG 45	1	1500830000	EPG 45	1	1500830000
	ES EPG 45 DIN 25	1	1501340000	ES EPG 45 DIN 25	1	1501340000
<b>Note</b>						

100 A...120 A – Plus connector

WBC-S-60R-B

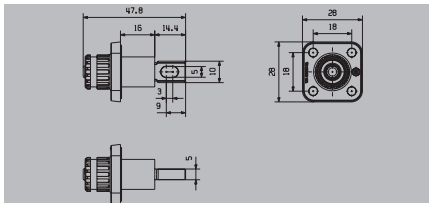

Technical data

Conductor cross-section, max.	25 mm <sup>2</sup>
Rated current	120 A
Type of connection	Screw connection
Colour	orange
Contact diameter, male Ø	6 mm
Type	Male
Volume resistance	≥ 5000 MΩ
Rated voltage	1500 V
Plugging cycles	≥ 100
Surface finish	silver
Material	PA 66
UL 94 flammability rating	V-0
Protection degree	IP67 plugged
Weight	23.6 GRM
Length / Width / Depth	28 / 28 / 47.8 mm
Approvals	UL 4128

Note

Ordering data

Type	Qty.	Order No.
WBC-S-60R-B	5	2905340000

Note

150 A...200 A - Minus connector

WBC-P-8BK-35

WBC-P-8BK-50

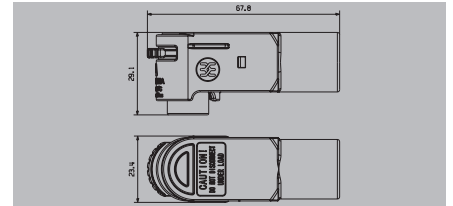
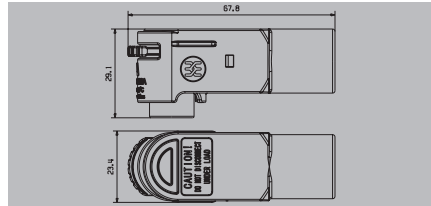

Technical data

Conductor cross-section, max.	35 mm <sup>2</sup>	50 mm <sup>2</sup>
Rated current	150 A	200 A
Outer cable diameter, min. / max.	10.6...11.3 mm	12.5...13.2 mm
Type of connection	Crimp connection	Crimp connection
Colour	black	black
Contact diameter, male Ø	8 mm	8 mm
Type	Female	Female
Volume resistance	≥ 5000 MΩ	≥ 5000 MΩ
Rated voltage	1500 V	1500 V
Plugging cycles	≥ 100	≥ 100
Surface finish	silver	silver
Material	PA 66	PA 66
UL 94 flammability rating	V-0	V-0
Protection degree	IP67 plugged	IP67 plugged
Weight	46 GRM	45 GRM
Length / Width / Depth	67.8 / 29.1 / 23.4 mm	67.8 / 29.1 / 23.4 mm
Approvals	UL 4128	UL 4128
<b>Note</b>		

Ordering data

Type	Qty.	Order No.
WBC-P-8BK-35	5	2905350000
<b>Note</b>		

Accessories

Tools	Type	Qty.	Order No.
Pressing tool	EPG 45	1	1500830000
Replacement crimp inserts	ES EPG 45 DIN 35	1	1501350000
<b>Note</b>			

150 A...200 A – Plus connector

WBC-P-80R-35

WBC-P-80R-50

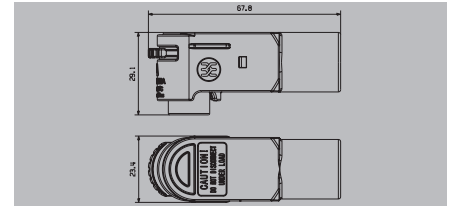
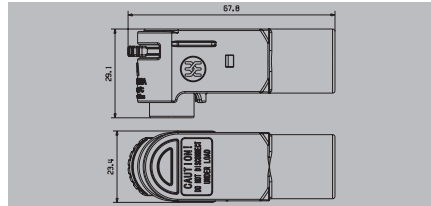

Technical data

Conductor cross-section, max.	35 mm <sup>2</sup>	50 mm <sup>2</sup>
Rated current	150 A	200 A
Outer cable diameter, min. / max.	10.6...11.3 mm	12.5...13.2 mm
Type of connection	Crimp connection	Crimp connection
Colour	orange	orange
Contact diameter, male Ø	8 mm	8 mm
Type	Female	Female
Volume resistance	≥ 5000 MΩ	≥ 5000 MΩ
Rated voltage	1500 V	1500 V
Plugging cycles	≥ 100	≥ 100
Surface finish	silver	silver
Material	PA 66	PA 66
UL 94 flammability rating	V-0	V-0
Protection degree	IP67 plugged	IP67 plugged
Weight	46 GRM	45 GRM
Length / Width / Depth	67.8 / 29.1 / 23.4 mm	67.8 / 29.1 / 23.4 mm
Approvals	UL 4128	UL 4128
<b>Note</b>		

Ordering data

Type	Qty.	Order No.
WBC-P-80R-35	5	2905360000
WBC-P-80R-50	5	2905380000
<b>Note</b>		

Accessories

Tools	Type	Qty.	Order No.
Pressing tool	EPG 45	1	1500830000
Replacement crimp inserts	ES EPG 45 DIN 35	1	1501350000
<b>Note</b>			

150 A...250 A - Minus connector

WBC-S-8BK-B

WBC-S-8BK-M6

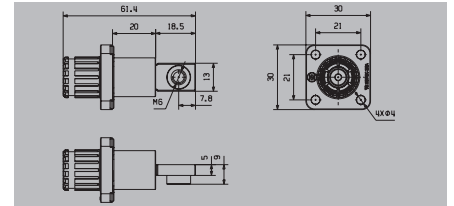
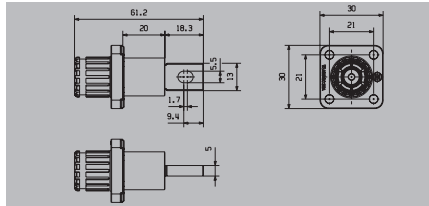

Technical data

Conductor cross-section, max.	50 mm <sup>2</sup>	50 mm <sup>2</sup>
Rated current	250 A	250 A
Type of connection	Screw connection	Screw connection
Colour	black	black
Contact diameter, male Ø	8 mm	8 mm
Type	Male	Male
Volume resistance	≥ 5000 MΩ	≥ 5000 MΩ
Rated voltage	1500 V	1500 V
Plugging cycles	≥ 100	≥ 100
Surface finish	silver	silver
Material	PA 66	PA 66
UL 94 flammability rating	V-0	V-0
Protection degree	IP67 plugged	IP67 plugged
Weight	46 GRM	49 GRM
Length / Width / Depth	30 / 30 / 61.2 mm	30 / 30 / 61.4 mm
Approvals	UL 4128	UL 4128
Note		

Ordering data

Type	Qty.	Order No.	Type	Qty.	Order No.
WBC-S-8BK-B	5	2905310000	WBC-S-8BK-M6	5	2918840000
Note					

150 A...250 A – Plus connector

WBC-S-80R-B

WBC-S-80R-M6

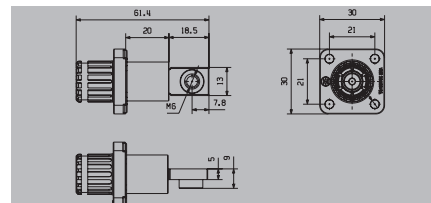
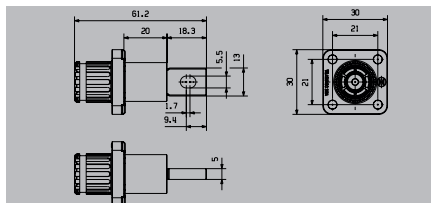

Technical data

Conductor cross-section, max.	50 mm <sup>2</sup>	50 mm <sup>2</sup>
Rated current	250 A	250 A
Type of connection	Screw connection	Screw connection
Colour	orange	orange
Contact diameter, male Ø	8 mm	8 mm
Type	Male	Male
Volume resistance	≥ 5000 MΩ	≥ 5000 MΩ
Rated voltage	1500 V	1500 V
Plugging cycles	≥ 100	≥ 100
Surface finish	silver	silver
Material	PA 66	PA 66
UL 94 flammability rating	V-0	V-0
Protection degree	IP67 plugged	IP67 plugged
Weight	46 GRM	49 GRM
Length / Width / Depth	30 / 30 / 61.2 mm	30 / 30 / 61.4 mm
Approvals	UL 4128	UL 4128
Note		

Ordering data

Type	Qty.	Order No.	Type	Qty.	Order No.
WBC-S-80R-B	5	2905320000	WBC-S-80R-M6	5	2918860000
Note					

## WBC – Battery Connector

## 250 A – Minus connector

## WBC-P-8BK-70

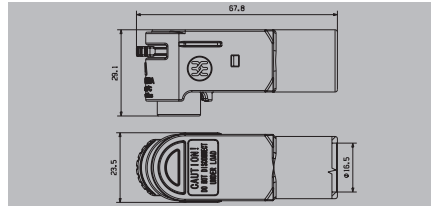

## Technical data

Conductor cross-section, max.	70 mm <sup>2</sup>
Rated current	250 A
Outer cable diameter, min. / max.	14.7...15.4 mm
Type of connection	Crimp connection
Colour	black
Contact diameter, male Ø	8 mm
Type	Female
Volume resistance	≥ 5000 MΩ
Rated voltage	1500 V
Plugging cycles	≥ 100
Surface finish	silver
Material	PA 66
UL 94 flammability rating	V-0
Protection degree	IP67 plugged
Weight	45.3 GRM
Length / Width / Depth	67.8 / 29.1 / 23.5 mm
Approvals	UL 4128

## Note

## Ordering data

## Note

Type	Qty.	Order No.
WBC-P-8BK-70	5	2995040000

## Accessories

## Tools

Pressing tool  
Replacement crimp inserts

## Note

Type	Qty.	Order No.
APG 80	1	2853270000
ES APG 80 DIN 70	1	1502890000

250 A – Plus connector

WBC-P-80R-70

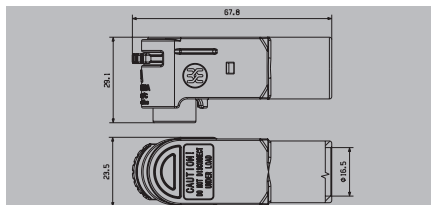

Technical data

Conductor cross-section, max.	70 mm <sup>2</sup>
Rated current	250 A
Outer cable diameter, min. / max.	14.7...15.4 mm
Type of connection	Crimp connection
Colour	orange
Contact diameter, male Ø	8 mm
Type	Female
Volume resistance	≥ 5000 MΩ
Rated voltage	1500 V
Plugging cycles	≥ 100
Surface finish	silver
Material	PA 66
UL 94 flammability rating	V-0
Protection degree	IP67 plugged
Weight	45.3 GRM
Length / Width / Depth	67.8 / 29.1 / 23.5 mm
Approvals	UL 4128
<b>Note</b>	

Ordering data

Type	Qty.	Order No.
WBC-P-80R-70	5	2995050000
<b>Note</b>		

Accessories

Type	Qty.	Order No.
APG 80	1	2853270000
ES APG 80 DIN 70	1	1502890000
<b>Note</b>		

Tools
Pressing tool
Replacement crimp inserts
<b>Note</b>

350 A - Minus connector

WBC-P-10BK-70

WBC-P-10BK-95

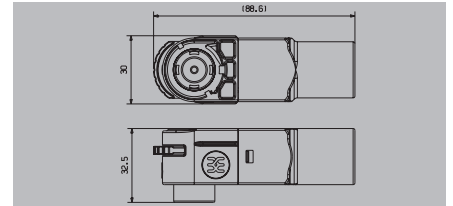
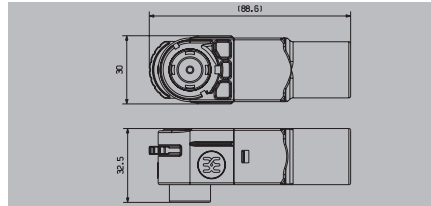

Technical data

Conductor cross-section, max.	70 mm <sup>2</sup>	95 mm <sup>2</sup>
Rated current	250 A	350 A
Outer cable diameter, min. / max.	15...16 mm	17.7...18.8 mm
Type of connection	Crimp connection	Crimp connection
Colour	black	black
Contact diameter, male Ø	10 mm	10 mm
Type	Female	Female
Volume resistance	≥ 5000 MΩ	≥ 5000 MΩ
Rated voltage	1500 V	1500 V
Plugging cycles	≥ 100	≥ 100
Surface finish	silver	silver
Material	PA 66	PA 66
UL 94 flammability rating	V-0	V-0
Protection degree	IP67 plugged	IP67 plugged
Weight	72.5 GRM	72.5 GRM
Length / Width / Depth	88.6 / 30 / 32.5 mm	88.6 / 30 / 32.5 mm
Approvals	UL 4128	UL 4128
<b>Note</b>		

Ordering data

Type	Qty.	Order No.
WBC-P-10BK-70	5	2991900000
<b>Note</b>		

Accessories

Type	Qty.	Order No.
APG 80	1	2853270000
ES APG 80 DIN 70	1	1502890000
<b>Note</b>		

350 A – Minus connector

WBC-S-10BK-M8

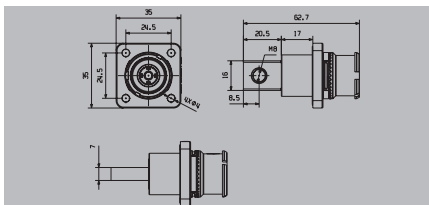

Technical data

Conductor cross-section, max.	95 mm <sup>2</sup>
Rated current	350 A
Type of connection	Screw connection
Colour	black
Contact diameter, male Ø	10 mm
Type	Male
Volume resistance	≥ 5000 MΩ
Rated voltage	1500 V
Plugging cycles	≥ 100
Surface finish	silver
Material	PA 66
UL 94 flammability rating	V-0
Protection degree	IP67 plugged
Weight	61.42 GRM
Length / Width / Depth	35 / 35 / 62.7 mm
Approvals	UL 4128

Note

Ordering data

Type	Qty.	Order No.
WBC-S-10BK-M8	5	2991920000

Note

350 A - Plus connector

WBC-P-10RE-70

WBC-P-10RE-95

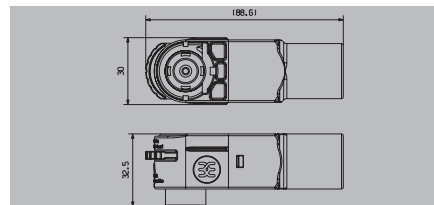
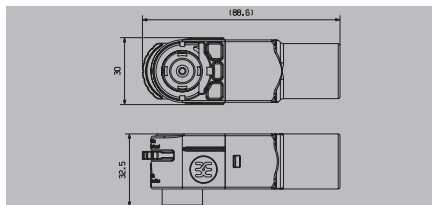

Technical data

Conductor cross-section, max.	70 mm <sup>2</sup>
Rated current	250 A
Outer cable diameter, min. / max.	15...16 mm
Type of connection	Crimp connection
Colour	red
Contact diameter, male Ø	10 mm
Type	Female
Volume resistance	≥ 5000 MΩ
Rated voltage	1500 V
Plugging cycles	≥ 100
Surface finish	silver
Material	PA 66
UL 94 flammability rating	V-0
Protection degree	IP67 plugged
Weight	72.5 GRM
Length / Width / Depth	88.6 / 30 / 32.5 mm
Approvals	UL 4128
<b>Note</b>	

Conductor cross-section, max.	95 mm <sup>2</sup>
Rated current	350 A
Outer cable diameter, min. / max.	17.7...18.8 mm
Type of connection	Crimp connection
Colour	red
Contact diameter, male Ø	10 mm
Type	Female
Volume resistance	≥ 5000 MΩ
Rated voltage	1500 V
Plugging cycles	≥ 100
Surface finish	silver
Material	PA 66
UL 94 flammability rating	V-0
Protection degree	IP67 plugged
Weight	72.5 GRM
Length / Width / Depth	88.6 / 30 / 32.5 mm
Approvals	UL 4128
<b>Note</b>	

Conductor cross-section, max.	95 mm <sup>2</sup>
Rated current	350 A
Outer cable diameter, min. / max.	17.7...18.8 mm
Type of connection	Crimp connection
Colour	red
Contact diameter, male Ø	10 mm
Type	Female
Volume resistance	≥ 5000 MΩ
Rated voltage	1500 V
Plugging cycles	≥ 100
Surface finish	silver
Material	PA 66
UL 94 flammability rating	V-0
Protection degree	IP67 plugged
Weight	72.5 GRM
Length / Width / Depth	88.6 / 30 / 32.5 mm
Approvals	UL 4128
<b>Note</b>	

Ordering data

<b>Note</b>	
-------------	--

Type	Qty.	Order No.
WBC-P-10RE-70	5	2991910000

Type	Qty.	Order No.
WBC-P-10RE-95	5	2991950000

Accessories

Tools
Pressing tool
Replacement crimp inserts
<b>Note</b>

Type	Qty.	Order No.
APG 80	1	2853270000
ES APG 80 DIN 70	1	1502890000

Type	Qty.	Order No.
APG 80	1	2853270000
ES APG 80 DIN 70	1	1502890000

350 A – Plus connector

WBC-S-10RE-M8

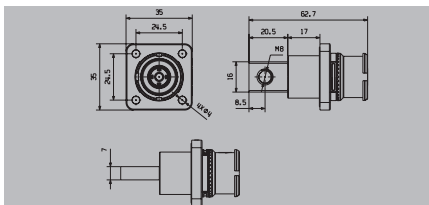

Technical data

Conductor cross-section, max.	95 mm <sup>2</sup>
Rated current	350 A
Type of connection	Screw connection
Colour	red
Contact diameter, male Ø	10 mm
Type	Male
Volume resistance	≥ 5000 MΩ
Rated voltage	1500 V
Plugging cycles	≥ 100
Surface finish	silver
Material	PA 66
UL 94 flammability rating	V-0
Protection degree	IP67 plugged
Weight	61.42 GRM
Length / Width / Depth	35 / 35 / 62.7 mm
Approvals	UL 4128

Note

Ordering data

Type	Qty.	Order No.
WBC-S-10RE-M8	5	2991930000

Note

Pre-assembled cable

WBC-CH-60R-BK-25-0023

WBC-CH-10RE-BK-95-0032

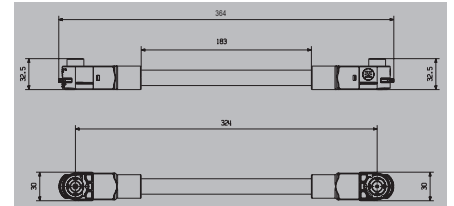
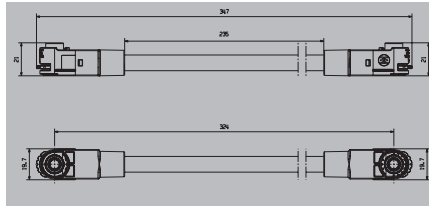

Technical data

Type of connection
Colour
Contact diameter, male Ø
Conductor cross-section, max.
Surface finish
Type
Length
Rated voltage
Rated current
Protection degree
Plugging cycles
Weight
Approvals
<b>Note</b>

Crimp connection
black, orange
6 mm
25 mm <sup>2</sup>
silver
Female
324 mm
1500 V
120 A
IP67 plugged
≥ 100
120 GRM
UL 4128

Crimp connection
black, orange
6 mm
95 mm <sup>2</sup>
silver
Female
324 mm
1500 V
350 A
IP67 plugged
≥ 100
500 GRM

Ordering data

<b>Note</b>
-------------

Type	Qty.	Order No.
WBC-CH-60R-BK-25-0023	1	2938270000

Type	Qty.	Order No.
WBC-CH-10RE-BK-95-0032	5	3072570000



# Lightning and Surge protection for energy storage systems

## Reliable Protection for power, signal and data

C



Battery energy storage systems are integral to modern energy grids, storing and redistributing energy from PV systems to balance fluctuations and meet peak demands. However, these systems are susceptible to direct exposure to lightning strikes and surges, necessitating a well-designed protection concept. It is crucial to shield sensitive electronics managing battery charging and discharging across the entire station. Surges often surpass the dielectric strength of installed electronic components, posing a risk to their integrity. Additionally, network-related voltage peaks can cause damage to electronic parts.

Implementing a comprehensive end-to-end surge protection concept is essential to prevent costly maintenance and downtime. This approach safeguards the entire system, ensuring the resilience and longevity of battery storage stations in the face of unpredictable external factors. By mitigating the impact of lightning and surges, this protective strategy contributes to the continuous and efficient operation of battery energy storage systems, supporting the stability of modern energy supply grid infrastructures.



For further products, information, technical specifications or additional services, please visit our website:  
[www.weidmuller.com/surge-protection](http://www.weidmuller.com/surge-protection)

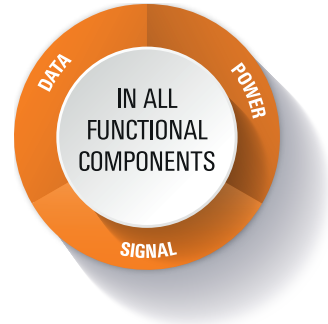

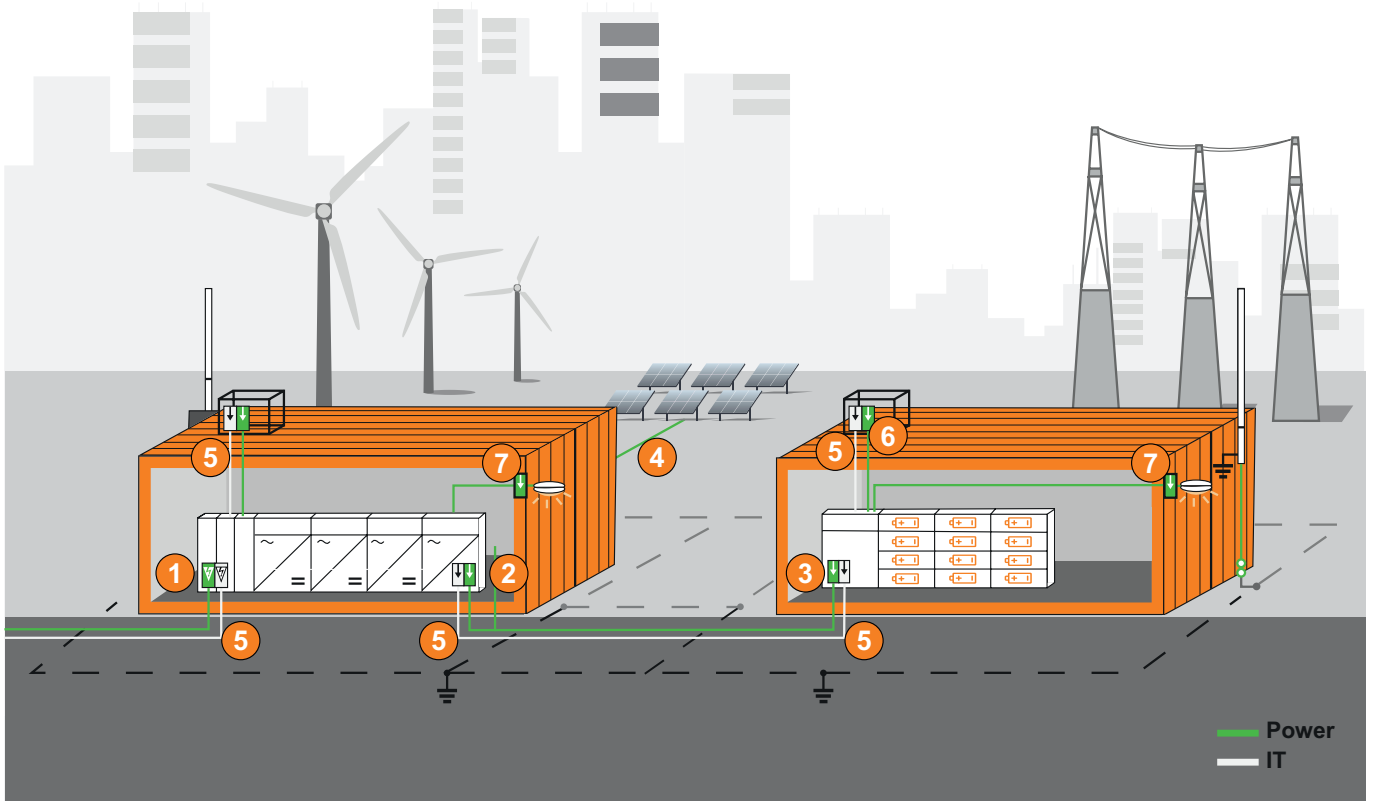

- 1** Grid feed in, inverter AC side, Compact lightning and surge protection for 230/400 V TN / TT grids
- 2** Inverter DC side, DC line protection, inverter cabinet
- 3** Battery stack DC, DC line protection, battery cabinet
- 4** PV array feed in, 1500 V DC / PV feed in protection
- 5** Ethernet communication, Protection of Ethernet communication
- 6** Rooftop AC system, Surge protection for Air Condition system
- 7** Outdoor lighting system, Single phase power line protection

No.	Location	Product	Comment	Order No.
1	Grid feed in, inverter AC side	VPU AC I 3+1 R 275/25 LCF S 2PE	Compact lightning and surge protection for 230/400 V TN / TT grids	2726770000*
2	Inverter DC side	VPU PV II 3 R 1500	DC line protection, inverter cabinet	2530650000
3	Battery stack DC	VPU PV II 3 R 1500	DC line protection, battery cabinet	2530650000
4	PV array feed in	VPU PV I+II 3 R 1500	1500 V DC/PV feed in protection	2530590000
5	Ethernet communication	VDATA Cat6	Protection of Ethernet communication	1348590000
6	Rooftop AC system	VPU AC II 3+1 R 300/50	Surge protection for Air Condition system	2591090000
7	Outdoor lighting system	VPU AC II 1+1 300/50	Single phase power line protection	2591060000

**Note** \* For use in DC applications, please use the DC fuse: 160 A/1500 V gBat  
\* not yet UL/UR approved



### Terminal blocks – Klippon® Connect

Panels have to master various tasks depending on the application. However varied the challenges may be, our answer is incredibly simple: Klippon® Connect combines all the requirements placed on the relevant industries now and in the future of Industry 4.0 production plants. The range of tailor-made application products, universal terminal blocks and process-supporting Klippon® Services offer the right solution whatever the panel concept.



For further products, information, technical specifications or additional services, please visit our website:  
[www.weidmuller.com/terminal-blocks](http://www.weidmuller.com/terminal-blocks)



#### S-Reihe – SNAP IN technology

Type	Version	Qty	Order No.
S2C 2.5	Feed-through terminal, SNAP IN, 2,5 mm <sup>2</sup> , 800 V, 24 A, dark beige	100	2674530000
S3C 2.5	Feed-through terminal, SNAP IN, 2,5 mm <sup>2</sup> , 800 V, 24 A, dark beige	100	2674540000
S4C 2.5	Feed-through terminal, SNAP IN, 2,5 mm <sup>2</sup> , 800 V, 24 A, dark beige	100	2674550000
S2C 4	Feed-through terminal, SNAP IN, 4 mm <sup>2</sup> , 800 V, 32 A, dark beige	50	2874820000
S3C 4	Feed-through terminal, SNAP IN, 4 mm <sup>2</sup> , 800 V, 32 A, dark beige	50	2874840000
S4C 4	Feed-through terminal, SNAP IN, 4 mm <sup>2</sup> , 800 V, 32 A, dark beige	50	2874860000
S2T 2.5	Feed-through terminal, SNAP IN, 2,5 mm <sup>2</sup> , 800 V, 24 A, dark beige	50	2902380000
S4C 2.5 PE	Protective earth terminal block, SNAP IN, 2,5 mm <sup>2</sup> , 800 V, green-yellow	50	2674580000
S2T 2.5 PE	Protective earth terminal block, SNAP IN, 2,5 mm <sup>2</sup> , 800 V, green-yellow	50	2902460000
S4C 4 PE	Protective earth terminal block, SNAP IN, 4 mm <sup>2</sup> , 800 V, green-yellow	50	2874900000

**SNAP IN**



#### A-Series – PUSH IN technology

Type	Version	Qty	Order No.
A2C 2.5	Feed-through terminal, PUSH IN, 2,5 mm <sup>2</sup> , 800 V, 24 A, dark beige	100	1521850000
A3C 2.5	Feed-through terminal, PUSH IN, 2,5 mm <sup>2</sup> , 800 V, 24 A, dark beige	100	1521740000
A4C 2.5	Feed-through terminal, PUSH IN, 2,5 mm <sup>2</sup> , 800 V, 24 A, dark beige	100	1521690000
A2C 4	Feed-through terminal, PUSH IN, 4 mm <sup>2</sup> , 800 V, 32 A, dark beige	100	2051180000
A3C 4	Feed-through terminal, PUSH IN, 4 mm <sup>2</sup> , 800 V, 32 A, dark beige	50	2051240000
A4C 4	Feed-through terminal, PUSH IN, 4 mm <sup>2</sup> , 800 V, 32 A, dark beige	50	2051500000
A2T 1.5	Feed-through terminal, Double-tier terminal, PUSH IN, 1,5 mm <sup>2</sup> , 500 V, 16 A, dark beige	50	2469370000
A2T 2.5	Feed-through terminal, Double-tier terminal, PUSH IN, 2,5 mm <sup>2</sup> , 800 V, 24 A, dark beige	50	1547610000
A2T 2.5 3C	Feed-through terminal, Double-tier terminal, PUSH IN, 2,5 mm <sup>2</sup> , 800 V, 22 A, dark beige	50	2531290000
A4C 2.5 PE	PE terminal, PUSH IN, 2,5 mm <sup>2</sup> , Green/yellow	50	1521540000
A3C 4 PE	PE terminal, PUSH IN, 4 mm <sup>2</sup> , Green/yellow	50	2051410000
ADT 2.5 2C	Test-disconnect terminal, PUSH IN, 2,5 mm <sup>2</sup> , 500 V, 20 A, dark beige	50	1989800000
ADT 2.5 4C	Test-disconnect terminal, PUSH IN, 2,5 mm <sup>2</sup> , 500 V, 20 A, dark beige	50	1989860000
ADT 4 2C	Test-disconnect terminal, PUSH IN, 4 mm <sup>2</sup> , 500 V, 20 A, dark beige	50	2429850000
A2T 2.5 DT/DT	PUSH IN, 2,5 mm <sup>2</sup> , 400 V, 16 A, dark beige	50	2744110000
AFS 4 2C BK	Fuse terminal, PUSH IN, 4 mm <sup>2</sup> , 400 V, 6.3 A, black	50	2429860000
AFS 4 2C 100-250V BK	Fuse terminal, PUSH IN, 4 mm <sup>2</sup> , 250 V, 6.3 A, black	50	2434390000

**PUSH IN**



#### A-Series high-current terminal blocks

Type	Version	Qty	Order No.
A2C 35	Feed-through terminal, PUSH IN, 35 mm <sup>2</sup> , 1000 V, 125 A, dark beige	10	2551510000
A2C 35 BL	Feed-through terminal, PUSH IN, 35 mm <sup>2</sup> , 1000 V, 125 A, blue	10	2552090000
A2C 50/70	Feed-through terminal, PUSH IN, 50 mm <sup>2</sup> , 1000 V, 150 A, dark beige	5	2663250000
A2C 50/70 BL	Feed-through terminal, PUSH IN, 50 mm <sup>2</sup> , 1000 V, 150 A, blue	5	2663260000
A2C 35 PE	PE terminal, PUSH IN, 35 mm <sup>2</sup> , 1000 V, Green/yellow	10	2551520000
A2C 50/70 PE	PE terminal, PUSH IN, 50 mm <sup>2</sup> , Green/yellow	5	2663280000

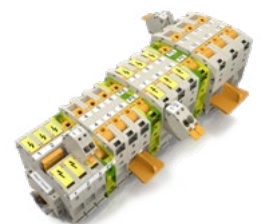

**W-Series – Clamping yoke technology**

Type	Version	Qty	Order No.
WDU 1.5/ZZ	Feed-through terminal, Screw connection, 1.5 mm <sup>2</sup> , 800 V, 17.5 A, dark beige	100	1031400000
WDU 2.5N	Feed-through terminal, Screw connection, 2.5 mm <sup>2</sup> , 500 V, 24 A, dark beige	100	1023700000
WDU 2.5	Feed-through terminal, Screw connection, 2.5 mm <sup>2</sup> , 800 V, 24 A, dark beige	100	1020000000
WDU 4	Feed-through terminal, Screw connection, 4 mm <sup>2</sup> , 800 V, 32 A, dark beige	100	1020100000
WDU 16N	Feed-through terminal, Screw connection, 16 mm <sup>2</sup> , 690 V, 76 A, dark beige	50	1036100000
WDU 16 BL	Feed-through terminal, Screw connection, 16 mm <sup>2</sup> , 1000 V, 76 A, blue	50	1020480000
WDK 4N V	Double-tier terminal, Screw connection, 4 mm <sup>2</sup> , 800 V, 32 A, dark beige	50	1041910000
WDK 2.5N V	Double-tier terminal, Screw connection, 2.5 mm <sup>2</sup> , 800 V, 24 A, dark beige	50	1041610000
WDK 2.5N	Double-tier terminal, Screw connection, 2.5 mm <sup>2</sup> , 800 V, 24 A, dark beige	50	1041600000
WPE 2.5N	PE terminal, Screw connection, 2.5 mm <sup>2</sup> , 300 A (2.5 mm <sup>2</sup> ), Green/yellow	50	1016200000
WPE 4	PE terminal, Screw connection, 4 mm <sup>2</sup> , 480 A (4 mm <sup>2</sup> ), Green/yellow	100	1010100000
WDK 2.5PE	PE terminal, Double-tier terminal, Screw connection, 2.5 mm <sup>2</sup> , 300 A (2.5 mm <sup>2</sup> ), Green/yellow	50	1036300000
WTR 2.5	Test-disconnect terminal, Screw connection, 2.5 mm <sup>2</sup> , 500 V, 24 A, Pivoting, dark beige	100	1855610000
WTR 4	Test-disconnect terminal, Screw connection, 4 mm <sup>2</sup> , 500 V, 32 A, Pivoting, dark beige	50	7910180000
WSI 25/1 10X38 1KV	W-Series, Fuse terminal, Rated cross-section: 25 mm <sup>2</sup> , Screw connection,	12	1137790000
WSI 25/1 10X38/LED 1KV	W-Series, Fuse terminal, Rated cross-section: 25 mm <sup>2</sup> , Screw connection,	12	1137780000
WSI 4	W-Series, Fuse terminal, Rated cross-section: 4 mm <sup>2</sup> , Screw connection,	50	1886580000

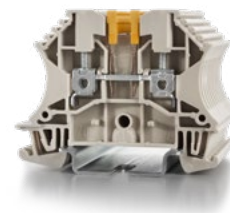

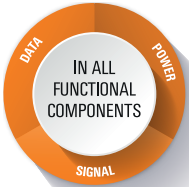

### Connection technology for battery management systems (BMS)

Our terminals and plug-in connectors: **OMNIMATE® 4.0** follows the trend of One Cable Technology (OCT). The modular concept enables the fast configuration of hybrid interfaces, which transmit data, signals and energy in a single connector. As a result, you can reduce the cabling effort in a wide variety of applications, simplify maintenance and accelerate automation processes. The unique SNAP IN connection is the backbone and speeds up the wiring process. **OMNIMATE® Signal** and **OMNIMATE® Power** are PCB terminal blocks, plug-in connector and panel feedthrough terminal blocks for industrial applications with a focus on signal processing and power electronics. **OMNIMATE® Data** are RJ45 and USB circuit board sockets for safe data transmission in the Industrial Ethernet environment. RJ45 components from Weidmüller ensure reliable transmission with high data rates up to 1 Gbit/s. The different design types of the RJ45 circuit board sockets allow adaptation to the individual enclosure design.



For further products, information, technical specifications or additional services, please visit our website: [www.weidmueller.com/omnimate](http://www.weidmueller.com/omnimate)



#### OMNIMATE® 4.0 – PCB plug-in connector in 5.00 mm pitch

Type	Version	Qty	Order No.
MPS 5/02 S TN B B	Female plug, Pitch in mm: 5.00 mm, Number of poles: 2, 180°, Box	168	2741560000
MPS 5/03 S TN B B	Female plug, Pitch in mm: 5.00 mm, Number of poles: 3, 180°, Box	114	2741570000
MPS 5/04 S TN B B	Female plug, Pitch in mm: 5.00 mm, Number of poles: 4, 180°, Box	84	2741580000
MPS 5/05 S TN B B	Female plug, Pitch in mm: 5.00 mm, Number of poles: 5, 180°, Box	72	2741590000
MPS 5/06 S TN B B	Female plug, Pitch in mm: 5.00 mm, Number of poles: 6, 180°, Box	60	2741600000
MPS 5/07 S TN B B	Female plug, Pitch in mm: 5.00 mm, Number of poles: 7, 180°, Box	48	2741610000
MPS 5/08 S TN B B	Female plug, Pitch in mm: 5.00 mm, Number of poles: 8, 180°, Box	42	2741620000
MHS 5/02 H T3 B T	Male header, THT/THR solder connection, Pitch in mm: 5.00 mm, Number of poles: 2, 90°, Tube	48	2741400000
MHS 5/03 H T3 B T	Male header, THT/THR solder connection, Pitch in mm: 5.00 mm, Number of poles: 3, 90°, Tube	33	2741420000
MHS 5/04 H T3 B T	Male header, THT/THR solder connection, Pitch in mm: 5.00 mm, Number of poles: 4, 90°, Tube	25	2741430000
MHS 5/05 H T3 B T	Male header, THT/THR solder connection, Pitch in mm: 5.00 mm, Number of poles: 5, 90°, Tube	20	2741440000
MHS 5/06 H T3 B T	Male header, THT/THR solder connection, Pitch in mm: 5.00 mm, Number of poles: 6, 90°, Tube	17	2741450000
MHS 5/07 H T3 B T	Male header, THT/THR solder connection, Pitch in mm: 5.00 mm, Number of poles: 7, 90°, Tube	15	2741460000
MHS 5/08 H T3 B T	Male header, THT/THR solder connection, Pitch in mm: 5.00 mm, Number of poles: 8, 90°, Tube	13	2741470000

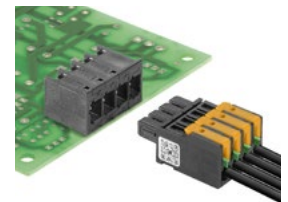

#### OMNIMATE® Data – SPE (Single Pair Ethernet) / SPE Patch cable

Type	Version	Qty	Order No.
IE-PCB-SPE-P-90V2.1-THR RL	Male header, Clip-on flange, THT/THR solder connection, 1.80 mm, Number of poles: 2, 90°, Solder pin length: 2.1 mm, Ni/Au, silver, Tape	100	2726010000
IE-PCB-SPE-P-90V2.1-THR-YG/RL	Male header, SClip-on flange, THT/THR solder connection, 1.80 mm, Number of poles: 2, 90°, Solder pin length: 2.1 mm, Ni/Au, black, Tape	100	2795120000
IE-PCB-SPE-P-180V2.1-THR RL	Male header, Clip-on flange, THT/THR solder connection, 1.80 mm, Number of poles: 2, 180°, Solder pin length: 2.1 mm, Ni/Au, silver, Tape	100	2795170000
IE-S1DS2VE0010T01T01-E	Patch cable, SPE plug (IEC 63171-2) - IP20 socket contact straight - IP20 socket contact straight, T1-B, PVC, 1 m	1	2725850010
IE-S1DS2VE0020T01T01-E	Patch cable, SPE plug (IEC 63171-2) - IP20 socket contact straight - IP20 socket contact straight, T1-B, PVC, 2 m	1	2725850020
IE-S1DS2VE0030T01T01-E	Patch cable, SPE plug (IEC 63171-2) - IP20 socket contact straight - IP20 socket contact straight, T1-B, PVC, 3 m	1	2725850030
IE-S1DS2VE0050T01T01-E	Patch cable, SPE plug (IEC 63171-2) - IP20 socket contact straight - IP20 socket contact straight, T1-B, PVC, 5 m	1	2725850050

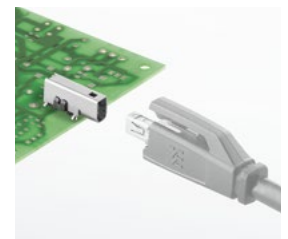

## OMNIMATE® Data – RJ45 jacks / RJ45 Patch cable

Type	Version	Qty	Order No.
RJ45C5 S1V 2.7N4N RL	Cat. 5, SMD solder connection, 180°, Shield tabs: none, 30...80 µm Ni / ≥ 30 µm Au, LED: No, Number of poles: 8, Tape	300	143390000*
RJ45C5 T1V 3.2N4N TY	Cat. 5, THT solder connection, 180°, Shield tabs: none, 30...80 µm Ni / ≥ 30 µm Au, LED: No, Number of poles: 8, Tray	120	143381000*
RJ45C6 R1V 3.2N4N TY	Cat. 6, THT/THR solder connection, 180°, LED: No, Number of poles: 8, Tape	140	263459000*
RJ45M R1V 1.9N4YG/YG TY	10/100 MBit/s, THT/THR solder connection, 180°, Shield tabs: none, 30...80 µm Ni / ≥ 30 µm Au, LED: Yes, Green/yellow, Number of poles: 8, Tray (manual assembly)	120	2562140000
RJ45C5 S1D 2.7N4N RL	Cat. 5, SMD solder connection, 90°, Latch option: bottom, Shield tabs: none, 30...80 µm Ni / ≥ 30 µm Au, LED: No, Number of poles: 8, Tape	260	143389000*
RJ45C5 R1V 3.2N4G/Y TY	Cat. 5, THT/THR solder connection, 180°, Shield tabs: none, 30...80 µm Ni / ≥ 30 µm Au, LED: Yes, green, yellow, Number of poles: 8, Tray	120	251638000*
RJ45C5 R1U 2.8N4G/Y RL	Cat. 5, THT/THR solder connection, 90°, Latch option: top, Shield tabs: none, 30...80 µm Ni / ≥ 30 µm Au, LED: Yes, green, yellow, Number of poles: 12, Tape	200	256295000*
IE-C6FP8L00002M40M40-0	Patch cable, RJ45 IP 20, RJ45 IP 20, <20 m: Cat.6A / >20 m Class EA (ISO/IEC 11801 2010), LSZH, 0.2 m	1	2563810002
IE-C6FP8L00005M40M40-0	Patch cable, RJ45 IP 20, RJ45 IP 20, <20 m: Cat.6A / >20 m Class EA (ISO/IEC 11801 2010), LSZH, 0.5 m	1	2563810005
IE-C6FP8L00010M40M40-0	Patch cable, RJ45 IP 20, RJ45 IP 20, <20 m: Cat.6A / >20 m Class EA (ISO/IEC 11801 2010), LSZH, 1 m	1	2563810010
IE-C6FP8L00020M40M40-0	Patch cable, RJ45 IP 20, RJ45 IP 20, <20 m: Cat.6A / >20 m Class EA (ISO/IEC 11801 2010), LSZH, 2 m	1	2563810020
Note	* not yet UL/UR approved		



## OMNIMATE® Signal – PCB terminals in 3.50 mm pitch – PUSH IN with actuator

Type	Version	Qty	Order No.
LSF-SMT 3.50/02/90 3.5SN BK TU	Number of poles: 2, 90°, Solder pin length: 3.5 mm, black, Clamping range, max.: 1.5 mm², Tube	71	1824420000
LSF-SMT 3.50/03/90 3.5SN BK TU	Number of poles: 3, 90°, Solder pin length: 3.5 mm, black, Clamping range, max.: 1.5 mm², Tube	49	1824430000
LSF-SMT 3.50/04/90 3.5SN BK TU	Number of poles: 4, 90°, Solder pin length: 3.5 mm, black, Clamping range, max.: 1.5 mm², Tube	37	1824440000
LSF-SMT 3.50/05/90 3.5SN BK TU	Number of poles: 5, 90°, Solder pin length: 3.5 mm, black, Clamping range, max.: 1.5 mm², Tube	30	1824450000
LSF-SMT 3.50/06/90 3.5SN BK TU	Number of poles: 6, 90°, Solder pin length: 3.5 mm, black, Clamping range, max.: 1.5 mm², Tube	25	1824460000
LSF-SMT 3.50/07/90 3.5SN BK TU	Number of poles: 7, 90°, Solder pin length: 3.5 mm, black, Clamping range, max.: 1.5 mm², Tube	21	1824470000
LSF-SMT 3.50/08/90 3.5SN BK TU	Number of poles: 8, 90°, Solder pin length: 3.5 mm, black, Clamping range, max.: 1.5 mm², Tube	19	1824480000



## OMNIMATE® Signal – LPCB plug-in connectors in 1.27 mm pitch Board-to-Board

Type	Version	Qty	Order No.
FFH9 S1/50V F1 B RL	Female header, SMD solder connection, Pitch in mm: 1.27 mm, Number of poles: 50, 180°, Tape	280	2747400000
FFH9 S1/26V F1 B RL	Female header, SMD solder connection, Pitch in mm: 1.27 mm, Number of poles: 26, 180°, Tape	280	2747370000
FMH3 S1/50V F1 B RL	Male header, SMD solder connection, Pitch in mm: 1.27 mm, Number of poles: 50, 180°, Tape	280	2747130000
FMH3 S1/26V F1 B RL	Male header, SMD solder connection, Pitch in mm: 1.27 mm, Number of poles: 26, 180°, Tape	280	2747100000
FC10 TN/26A S1 B BX	Female plug, Pitch in mm: 1.27 mm, Number of poles: 26, Box	10	282709000*
FFP D1/50H S1 B TY	Female plug, Pitch in mm: 1.27 mm, Number of poles: 50, Tray (manual assembly)	75	2747580000
Note	* not yet UL/UR approved		



## OMNIMATE® Signal – PCB plug-in connector in 3.50 mm pitch

Type	Version	Qty	Order No.
BLF 3.50/02/180 SN OR BX	Female plug, Number of poles: 2, 180°, PUSH IN with actuator, Clamping range, max.: 1.5 mm², Box	264	2458950000
BLF 3.50/03/180 SN OR BX	Female plug, Number of poles: 3, 180°, PUSH IN with actuator, Clamping range, max.: 1.5 mm², Box	174	2459060000
BLF 3.50/04/180 SN OR BX	Female plug, Number of poles: 4, 180°, PUSH IN with actuator, Clamping range, max.: 1.5 mm², Box	132	2459070000
BLF 3.50/05/180 SN OR BX	Female plug, Number of poles: 5, 180°, PUSH IN with actuator, Clamping range, max.: 1.5 mm², Box	102	2459080000
BLF 3.50/06/180 SN OR BX	Female plug, Number of poles: 6, 180°, PUSH IN with actuator, Clamping range, max.: 1.5 mm², Box	84	2459090000
BLF 3.50/07/180 SN OR BX	Female plug, Number of poles: 7, 180°, PUSH IN with actuator, Clamping range, max.: 1.5 mm², Box	72	2459100000
BLF 3.50/08/180 SN OR BX	Female plug, Number of poles: 8, 180°, PUSH IN with actuator, Clamping range, max.: 1.5 mm², Box	66	2459110000
SL 3.50/02/90 3.2SN OR BX	Male header, open side, THT solder connection, Number of poles: 2, 90°, Solder pin length: 3.2 mm, tinned, Box	100	1597210000
SL 3.50/03/90 3.2SN OR BX	Male header, open side, THT solder connection, Number of poles: 3, 90°, Solder pin length: 3.2 mm, tinned, Box	100	1597220000
SL 3.50/04/90 3.2SN OR BX	Male header, open side, THT solder connection, Number of poles: 4, 90°, Solder pin length: 3.2 mm, tinned, Box	100	1597230000
SL 3.50/05/90 3.2SN OR BX	Male header, open side, THT solder connection, Number of poles: 5, 90°, Solder pin length: 3.2 mm, tinned, Box	50	1597240000
SL 3.50/06/90 3.2SN OR BX	Male header, open side, THT solder connection, Number of poles: 6, 90°, Solder pin length: 3.2 mm, tinned, Box	50	1597250000
SL 3.50/07/90 3.2SN OR BX	Male header, open side, THT solder connection, Number of poles: 7, 90°, Solder pin length: 3.2 mm, tinned, Box	50	1597260000
SL 3.50/08/90 3.2SN OR BX	Male header, open side, THT solder connection, Number of poles: 8, 90°, Solder pin length: 3.2 mm, tinned, Box	50	1597270000

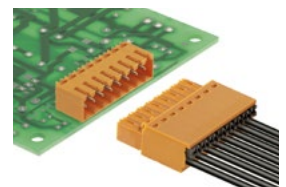

## OMNIMATE® Power – PCB terminals in 10.00 mm pitch – PUSH IN with actuator

Type	Version	Qty	Order No.
LUF 10.00/01/90 5.0SN BK BX	Number of poles: 1, 90°, Solder pin length: 5 mm, black, Clamping range, max.: 16 mm², Box	50	1988590000
LUF 10.00/02/90 5.0SN BK BX	Number of poles: 2, 90°, Solder pin length: 5 mm, black, Clamping range, max.: 16 mm², Box	40	1988600000
LUF 10.00/03/90 5.0SN BK BX	Number of poles: 3, 90°, Solder pin length: 5 mm, black, Clamping range, max.: 16 mm², Box	40	1988610000
LUF 10.00/04/90 5.0SN BK BX	Number of poles: 4, 90°, Solder pin length: 5 mm, black, Clamping range, max.: 16 mm², Box	30	1988620000
LUF 10.00/05/90 5.0SN BK BX	Number of poles: 5, 90°, Solder pin length: 5 mm, black, Clamping range, max.: 16 mm², Box	25	1988630000



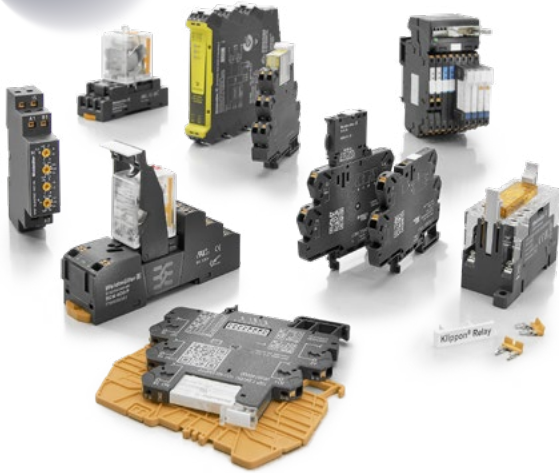
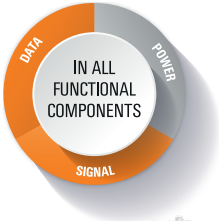

## Relay Modules & Solid-State Relays – Klippon® Relay

Switch to simple – with Klippon® Relay – High-quality relays with unique all-round service

Whether switching, separating, amplifying, or multiplying: relays perform a multitude of different tasks in industrial applications. They have very specific characteristics and are available in almost innumerable varieties on the market. Klippon® Relay from Weidmüller makes your choice easy. Our worldwide unique all-round offer combines maximum relay variety with matching accessories and first-class service. We provide you with high-quality products that have been thought out down to the smallest detail, combined with comprehensive support from product selection to modern data services. Only with Klippon® Relay you can be sure to get the right relay for your specific needs – and save time and money. That's our promise!



For further products, information, technical specifications or additional services, please visit our website:  
[www.weidmueller.com/klipponrelay](http://www.weidmueller.com/klipponrelay)



### TERMSERIES-compact – relay modules

Type	Version	Qty	Order No.
TRPL 24-230VUC 1CO	Number of contacts: 1, CO contact AgNi, Rated control voltage: 24...230 V UC ±10 %, Continuous current: 6 A, PUSH IN, Test button available: No	10	2773860000*
TRPL 12-60VUC 1CO	Number of contacts: 1, CO contact AgNi, Rated control voltage: 12...60 V UC ±10 %, Continuous current: 6 A, PUSH IN, Test button available: No	10	2773770000*
TRPL 24VDC 1CO	Number of contacts: 1, CO contact AgNi, Rated control voltage: 24 V DC ±20 %, Continuous current: 6 A, PUSH IN, Test button available: No	10	2773890000
<b>Note</b>	* not yet UL/UR approved		



### TERMSERIES – relay modules

Type	Version	Qty	Order No.
TRP 24VDC 1CO AGSNO AU PB	Number of contacts: 1, CO contact AgSnO gold-plated, Rated control voltage: 24 V DC ±20 %, Continuous current: 6 A, PUSH IN, Test button available: Yes	10	2855830000
TRP 24VDC 1CO AGSNO PB	Number of contacts: 1, CO contact AgSnO, Rated control voltage: 24 V DC ±20 %, Continuous current: 6 A, PUSH IN, Test button available: Yes	10	2855800000
TRS 24VDC 1CO AGSNO AU PB	Number of contacts: 1, CO contact AgSnO gold-plated, Rated control voltage: 24 V DC ±20 %, Continuous current: 6 A, Screw connection, Test button available: Yes	10	2855860000
TRS 24VDC 1CO AGSNO PB	Number of contacts: 1, CO contact AgSnO, Rated control voltage: 24 V DC ±20 %, Continuous current: 6 A, Screw connection, Test button available: Yes	10	2855870000
TRP 24-230VUC 1CO AGSNO ED2 PB	Number of contacts: 1, CO contact AgSnO, Rated control voltage: 24...230 V UC ±10 %, Continuous current: 6 A, PUSH IN, Test button available: Yes	10	2855910000
TRP 24VDC 2CO	Number of contacts: 2, CO contact AgNi, Rated control voltage: 24 V DC ±20 %, Continuous current: 8 A, PUSH IN, Test button available: No	10	2618400000
TRP 24-230VUC 2CO ED2	Number of contacts: 2, CO contact AgNi, Rated control voltage: 24...230 V UC ±10 %, Continuous current: 8 A, PUSH IN, Test button available: No	10	2663040000
TRP 24VDC 1NO HC	Number of contacts: 1, NO contact AgSnO, Rated control voltage: 24 V DC ±20 %, Continuous current: 16 A, PUSH IN, Test button available: No	10	2618090000
TRP 24VDC 1NO HCP	Number of contacts: 1, NO contact AgSnO + W, Rated control voltage: 24 V DC ±20 %, Continuous current: 16 A, PUSH IN, Test button available: No	10	2617930000
TRP 24-230VUC 2CO ED2	Number of contacts: 2, CO contact AgNi, Rated control voltage: 24...230 V UC ±10 %, Continuous current: 8 A, PUSH IN, Test button available: No	10	2663040000
TRP 24VDC 2CO	Number of contacts: 2, CO contact AgNi, Rated control voltage: 24 V DC ±20 %, Continuous current: 8 A, PUSH IN, Test button available: No	10	2618400000



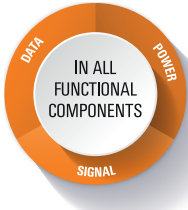

## Power connections for battery storage

RockStar® Currently, heavy-duty connectors are used wherever there is a need for a secure, simple and time-saving assembly of machinery and facilities. The connector housings are made of die-cast aluminium and offer excellent protection against dirt, moisture and mechanical stress. Special modular connectors make it possible to integrate signals, power supply and data connections into a single connector. With the RockStar® heavy-duty connectors, Weidmüller offers a product line with many patented innovations that is oriented towards the future.

The RockStar® product line defines new standards with the comprehensive depth and width of its features. What other suppliers offer only as a custom configuration, Weidmüller supplies in its standard product line. As a result, selecting the proper connector is now easier than ever. You save both time and money. And your work flow is optimised. Thus you can strengthen your position on the market and leverage your competitive advantage.



For further products, information, technical specifications or additional services, please visit our website:  
[www.weidmuller.com/rockstar](http://www.weidmuller.com/rockstar)



## Fixed-pole inserts and IP65 housings

- Industrial connectors with safe transmission of currents up to 35 amps and voltages up to 830 volts
- Reliable signal transmission at packing densities up to 216 poles
- Screw, tension spring, crimp, axial, PUSH IN, and SNAP IN connection

### RockStar® Heavy-duty connectors

Type	Version	Connection system	Qty.	Order No.
<b>HDC connection, 4-pin, 400 V, 16 A, size 1, M20, IP65</b>				
HDC HA 4 FS	Insert, pin	Screw connection	1	1498400000
HDC HA 4 MS	Insert, socket	Screw connection	1	1498300000
HDC 04A ALU	Bulkhead housing		1	1497600000
HDC 04A AWLU	Angled bulkhead housing		1	1497700000*
HDC 04A TOLU 1M20G	Plug housing, cable entry at top		1	1788820000
<b>HDC connection, 24-pin, 500 V, 16 A, size 8, M32, IP65</b>				
HDC HE 24 MQT	Insert, pin	SNAP IN connection	1	2667010000
HDC HE 24 FP	Insert, pin	PUSH IN connection	1	1873580000
HDC HE 24 FS	Insert, pin	Screw connection	1	1211300000
HDC HE 24 FQT	Insert, socket	SNAP IN connection	1	2666990000
HDC HE 24 MP	Insert, socket	PUSH IN connection	1	1873590000
HDC HE 24 MS	Insert, socket	Screw connection	1	1211100000
HDC 24B ADLU	Bulkhead housing		1	1214300000
HDC 64D SDLU 1M32G	Base housing		1	1904440000
HDC 24B TSLU 1M32G	Plug housing, cable entry sideways		1	1787790000
<b>Note</b>	* not yet UL/UR approved			



# RockStar® HighPower

C

Uncompromising power – in clever and safe packaging. The RockStar® HighPower modular high-current connector system has been custom designed for the high demand applications. The modular set-up consists of one-piece crimp contacts, insulating sleeves, insert-holder frames and a robust multi-part die-cast aluminium enclosure in IP68, as well as cross-connection options.



This modular design offers clear advantages for handling: It is possible to wire crimped lines with large cross-sections and to see this process through to the final step. The wiring can be achieved using standard cable glands.

**Your special advantages:**

- High performance in the smallest space due to modular design
- Integrated shield connection and 360° contacting
- Fine stranded copper conductors can be connected up to a size of 240 mm² with low-maintenance crimp connection technology

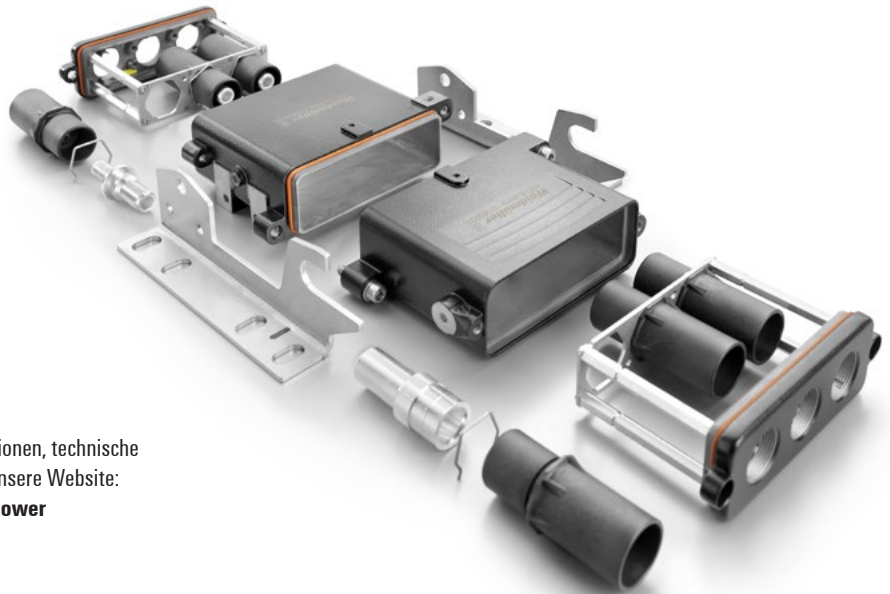

Nutzen Sie für weitere Produkte, Informationen, technische Angaben oder auch zusätzliche Services unsere Website: [www.weidmueller.com/rockstar-highpower](http://www.weidmueller.com/rockstar-highpower)

**Safe**

Tried-and-tested, low-maintenance crimp-connection technology with stranded, finely stranded and very finely stranded flexible copper conductors measuring up to 240 mm² with standardised tools

**Practical and universal**

A multitude of potential applications have been made pluggable for the first time ever – simply by integrating cross-connections.

**Perfectly optimised shielding**

Along with the 360° contact, the shielding connection integrated in the enclosure is the cutting edge of what is technically feasible at present.



**RockStar® HighPower: the modular 550 A plug-in connector**

Type	Rated current	Rated voltage	Conductor connection cross-section	Number of poles	Version	Qty.	Order No.
<b>Bulkhead housing</b>							
HDC IP68 HP 24B A						1	1120040000*
<b>Base housing</b>							
HDC IP68 HP 24B AS S						1	1079920000*
<b>Plug housing</b>							
HDC IP68 HP 24B T0						1	1079930000*
<b>Contact holder frame</b>							
HDC 24B HP550 MPL2 TYP1				2	Pin	1	1103710000*
HDC 24B HP550 MPL2 TYP2				2	Socket	1	1103770000*
<b>550 A Crimpkontakte</b>							
HDC HP 550 M 240	550 A	3000 V	240 mm <sup>2</sup>		Pin	1	1120590000*
HDC HP 550 F 240	550 A	3000 V	240 mm <sup>2</sup>		Socket	1	1120600000*
<b>Cover for cable glands</b>							
HDC IP68 24B MD 2M40					2xM40	1	1119990000*
<b>Cable gland</b>							
VGM40-MS68 20-32 BG					M40	10	1193620000*
<b>Note</b>	* not yet UL/UR approved						



C



# RockStar® ModuPlug

## Great performance in the smallest of spaces

Industrial applications are becoming increasingly complex. The demands being made of the connectivity used are growing at the same time. Functionality in the smallest of installation spaces, safe installation and a fast retrofitting process are just some of the product properties being called for.

Not only does our RockStar® ModuPlug modular plug-in connector system meet current market requirements; it has been specially designed with the future in mind too. Thanks to the new variety of module sizes, you can fit more applications than ever before in one plug-in connector. The modules reduce the amount of space required and cut costs when compared with fixed-pole inserts and other modular plug-in connector systems. The sophisticated frames and modules can be installed with extreme ease and integrated into HDC enclosures with the IP65 and IP68 protection classes. You can even use the RockStar® ModuPlug to supplement existing applications without any need to make system adjustments.

### Your special advantages:

- Optimum use of installation space and high flexibility thanks to the new module widths „Half 0.5“ and „Single Plus 1.5“
- Simple and safe assembly of the coded modular modules and the unique slide frame
- Innovative data modules transmit up to 10 Gbit/s

### Terminal block modules

The new terminal block modules with PUSH IN connection technology open up unexpected possibilities – especially for distribution solutions in the otherwise unused area on the control cabinet wall. With up to 48 poles in one connector, they enable particularly efficient wiring from the field to the devices in the control cabinet.

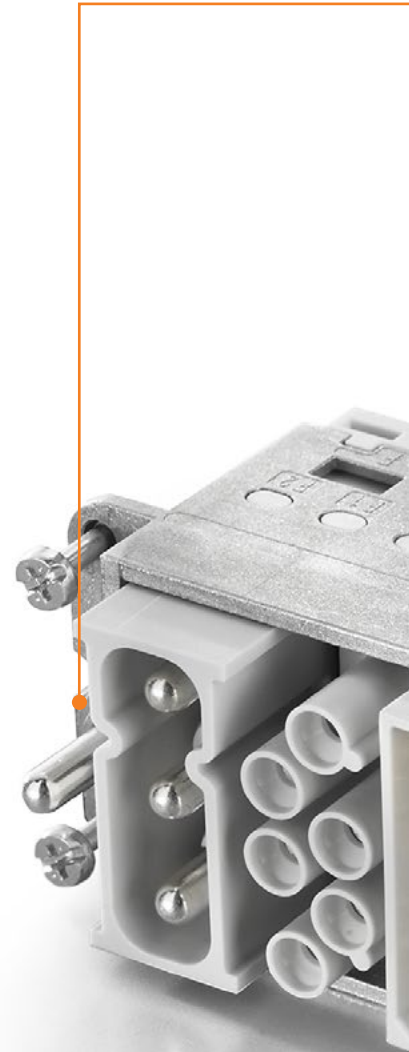

Nutzen Sie für weitere Produkte, Informationen, technische Angaben oder auch zusätzliche Services unsere Website:  
[www.weidmueller.com/moduplug](http://www.weidmueller.com/moduplug)

**Simple**

The innovative sliding frame has two defined locking positions for opening and closing – thus enabling simple, tool-free module installation.

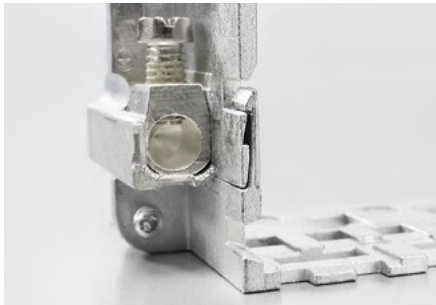

**Secure**

The round and rectangular coding on the frame enables intuitive module plug-in. The two-point fixation prevents incorrect connection and keeps the modules tilt and vibration-resistant.

**C**

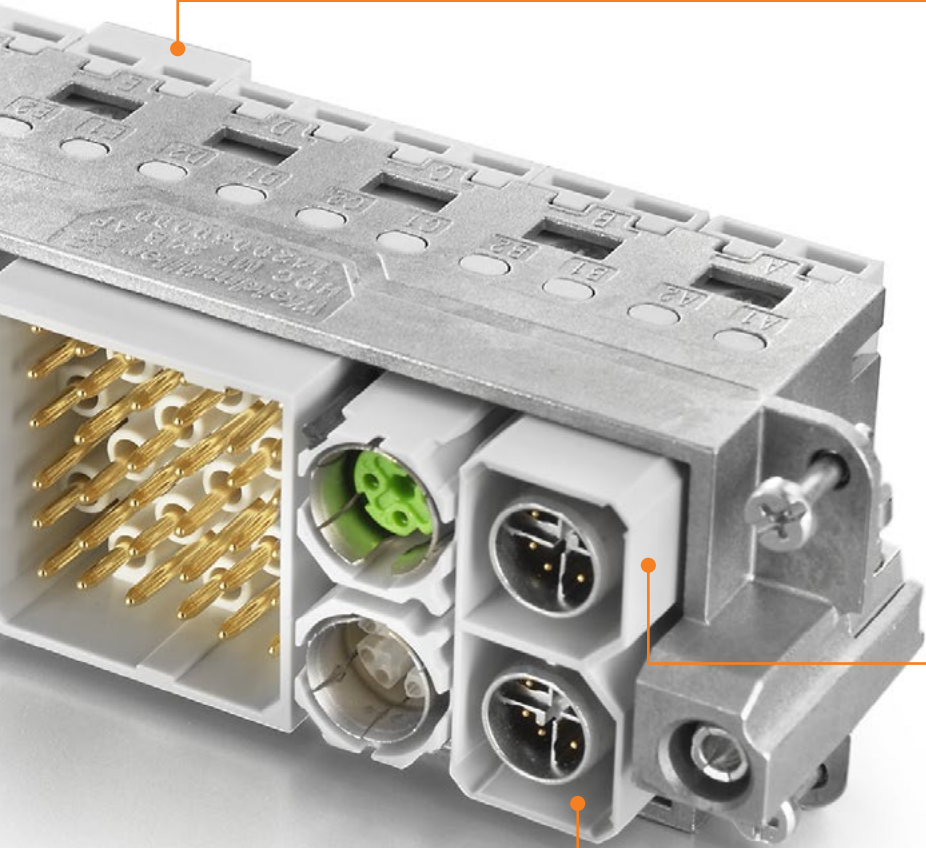

**Flexible**

The four module sizes make for individual plug solutions that save a huge amount of space. The smaller pitch translates into an optimised design too.

**Compact**

The new two-pole bus module is particularly compact and can accommodate megabit and gigabit data inserts. It enables the transmission of two Gigabit Cat 6A (10Gbit) cables in one module.

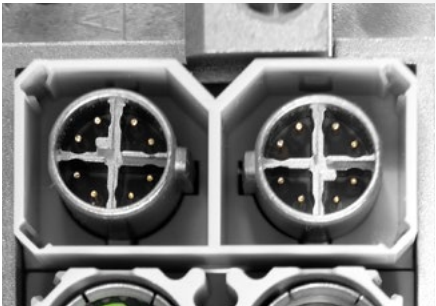
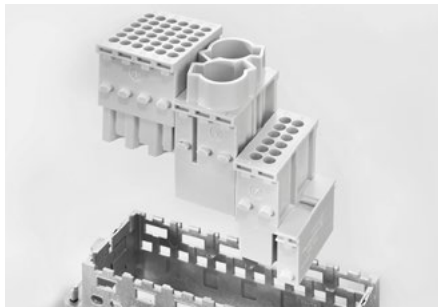

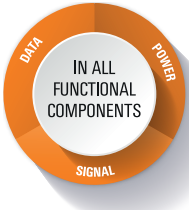

## Power Supplies

The switch-mode power supplies feature a high efficiency, compact dimensions and minimal heat generation. They are an excellent and reliable solution for providing power in all automation applications – safely providing 24 V DC and 48 V DC voltage. The different product series are optimised for the automation industry: they feature Ex approvals for the processing industry, a flat shape perfect for distribution tasks within buildings and provide decentralised control voltages.

All-purpose usage: with a wide range of AC/DC inputs, single-, double- or three-phase versions and a wide temperature range. Additional performance increases are possible using simple parallel connection. Weidmüller switch-mode power supplies are reliable usable for all applications because of their high efficiency and their resistance to both short circuits and overloads.



For further products, information, technical specifications or additional services, please visit our website:  
[www.weidmuller.com/powermanagement](http://www.weidmuller.com/powermanagement)



### Connect Power PROtop

Type	Version	Qty	Order No.
<b>Connect Power PROtop single-phase</b>			
PRO TOP1 120W 24V 5A	Power supply, switch-mode power supply unit, 24 V	1	2466870000
PRO TOP1 240W 24V 10A	Power supply, switch-mode power supply unit, 24 V	1	2466880000
PRO TOP1 480W 24V 20A	Power supply, switch-mode power supply unit, 24 V	1	2466890000
PRO TOP1 960W 24V 40A	Power supply, switch-mode power supply unit, 24 V	1	2466900000
PRO TOP1 480W 48V 10A	Power supply, switch-mode power supply unit, 48 V	1	2467030000
PRO TOP1 960W 48V 20A	Power supply, switch-mode power supply unit, 48 V	1	2466920000
<b>Connect Power PROtop for highest demands, 3-phase</b>			
PRO TOP3 120W 24V 5A CO	Power supply, switch-mode power supply unit, 24 V	1	2467070000
PRO TOP3 240W 24V 10A CO	Power supply, switch-mode power supply unit, 24 V	1	2467090000
PRO TOP3 480W 24V 20A CO	Power supply, switch-mode power supply unit, 24 V	1	2467110000
PRO TOP3 960W 24V 40A CO	Power supply, switch-mode power supply unit, 24 V	1	2467130000
PRO TOP3 480W 48V 10A	Stromversorgung, Schaltnetzgerät, 48 V	1	2467150000
PRO TOP3 960W 48V 20A	Stromversorgung, Schaltnetzgerät, 48 V	1	2467170000



### Connect Power PROmax

Type	Version	Qty	Order No.
<b>Connect Power PROmax single-phase</b>			
PRO MAX 70W 5V 14A	Power supply, switch-mode power supply unit, 5 V	1	1478210000
PRO MAX 72W 24V 3A	Power supply, switch-mode power supply unit, 24 V	1	1478100000
PRO MAX 240W 24V 10A	Power supply, switch-mode power supply unit, 24 V	1	1478130000
PRO MAX 480W 24V 20A	Power supply, switch-mode power supply unit, 24 V	1	1478140000
PRO MAX 960W 24V 40A	Power supply, switch-mode power supply unit, 24 V	1	1478150000
PRO MAX 240W 48V 5A	Power supply, switch-mode power supply unit, 48 V	1	1478240000
PRO MAX 480W 48V 10A	Power supply, switch-mode power supply unit, 48 V	1	1478250000
PRO MAX 960W 48V 20A	Power supply, switch-mode power supply unit, 48 V	1	1478270000
<b>Connect Power PROmax 3-phase</b>			
PRO MAX3 120W 24V 5A	Power supply, switch-mode power supply unit, 24 V	1	1478170000
PRO MAX3 240W 24V 10A	Power supply, switch-mode power supply unit, 24 V	1	1478180000
PRO MAX3 480W 24V 20A	Power supply, switch-mode power supply unit, 24 V	1	1478190000
PRO MAX3 960W 24V 40A	Power supply, switch-mode power supply unit, 24 V	1	1478200000



**DC/DC converter**

Type	Version	Qty	Order No.
PRO TOPDC 24V/24V 5A	DC/DC converter	1	2627650000*
PRO TOPDC 24V/24V 10A	DC/DC converter	1	2627640000*
PRO TOPDC 24V/24V 20A	DC/DC converter	1	2627630000*
PRO TOPDC 24V/48V 10A	DC/DC-Wandler	1	2627660000*
<b>Note</b>	* not yet UL/UR approved		

**maxGUARD – Electronic load monitoring**

Type	Version	Qty	Order No.
AMG AM CO	Alarm module, 24 V DC	1	2082770000
AMG CM	Control module, 24 V DC	1	2081900000
AMG ELM-18	Electronic load monitoring, 18 A, 24 V DC	10	2859800000
AMG DIS	Potential distributor	10	2123050000
AMG ELM-18	Electronic load monitoring, 18 A, 24 V DC	10	2859800000
AMG MD	Potential distributor	10	2122930000
AMG PD	Potential distributor	10	2122920000

**topGUARD – Electronic load monitoring**

Type	Version	Qty	Order No.
TGD FIM-C	Supply module	1	2625000000

**Communication modules**

Type	Version	Qty	Order No.
PRO COM DISPLAY 7S	Communication module	1	2466960000
PRO COM IO-LINK	Communication module	1	2587360000
PRO COM CAN OPEN	Communication module	1	2467320000

**UPS control unit**

Type	Version	Qty	Order No.
CP DC UPS 24V 20A/10A	UPS control unit	1	1370050010

**Battery module**

Type	Version	Qty	Order No.
DURA ECO LA-BAT 24V 7AH	Battery	1	2789910000
DURA ECO LA-BAT 24V 12AH	Battery	1	2789920000
DURA ECO LA-BAT 24V 17AH	Battery	1	2789930000



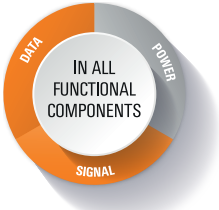

### Industrial Ethernet

Weidmüller Industrial Ethernet components are the perfect link for data communication between Ethernet enabled devices in industrial automation. By supporting various topologies and protocols, they can be used in many industrial applications. As a complete provider of industrial network infrastructure for machine and equipment manufacture, we offer a wide range of switch products to suit the individual needs of our customers. In particular, Gigabit switches (unmanaged and managed) and media converters, Power-over-Ethernet switches, WLAN devices and serial/Ethernet converters to meet the highest requirements and provide a reliable and flexible Ethernet communication. An extensive passive product portfolio consisting of RJ 45 and fibre optic connectors and cables make Weidmüller your partner for industrial Ethernet solutions.



For further products, information, technical specifications or additional services, please visit our website: [www.weidmueller.com/ie](http://www.weidmueller.com/ie)



#### Industrial Ethernet – Active components

Type	Version	Qty	Order No.
IE-SW-EL05-5TX	Network switch, unmanaged, Fast Ethernet, Number of ports: 5x RJ45, IP30, -40 °C...75 °C	1	2682130000
IE-SW-EL10-8GT-2GESFP	Network switch, unmanaged, Gigabit Ethernet, Number of ports: 8x RJ45, 2x 100/1000BaseSFP Slot, IP30, -40 °C...75 °C	1	2682240000
IE-SW-EL08-8POE	Network switch, unmanaged PoE, Fast Ethernet, Number of ports: 8x RJ45 10/100 BaseT(X) PoE+, IP30, -40 °C...75 °C	1	2682380000
IE-SW-AL12M-8GT-4GESFP	Netzwerk Switch, managed, Gigabit Ethernet, Anzahl Ports: 8x RJ45, 4x 100/1000BaseSFP Slot, IP30, -40 °C...75 °C	1	2682340000
IE-SW-SL20M-8GT-12GESFP-HV	Layer 2 Network Switch, managed, Gigabit Ethernet, IEC 61850-3 / IEEE 1613, high voltage, Number of ports: 8x RJ45, 12x 100/1000BaseSFP Slot, IP30, -40 °C...85 °C	1	2778970000
IE-SW-SL28M-HV	Layer 2 Network Switch, Modular, 19" rack mount, managed, Fast/Gigabit/10-Gigabit Ethernet, IEC 61850-3 / IEEE 1613, high voltage, Number of ports: up to 28 (depending on used media interface modules), IP30, -40 °C...85 °C	1	2779010000
IE-SFP-1GE-SM-10	SFP Transceiver, 1000 Mbps, Singlemode, LC-Duplex, 10 km, -40 °C...85 °C	1	2682500000
IE-CS-MBGW-2TX-1COM	Serial/Ethernet converter and Modbus TCP/RTU gateway, Number of ports: 2x RJ45 10/100BASE-T(X), 1x DB9 male for RS-232/422/485, IP30, -40 °C...70 °C	1	2682600000
IE-WLT-BL-AP-CL-EU	Wireless Access Point/Client, IEEE 802.11 a/b/g/n, EU-Model, IP30, -40 °C...75 °C	1	2536650000
IE-SR-4TX-LTE/4G-EU	Security/NAT/VPN/u-link Router, with integrated multi-band modem (4G/3G/2G), EU-model, Fast Ethernet, 4x RJ45 10/100BaseT(X), IP30, -30 °C...70 °C	1	2751280000
U-LINK-50-DEVICES-1Y	License code for u-link Remote Access Service., Adds 50 additional configurable u-link clients on Weidmüller hardware to the basic license and extends the period of the basic license accordingly	1	2870090000



#### Industrial Ethernet – Passive component

Type	Version	Qty	Order No.
IE-FC-SET-IPDED003-KY-M	Service Interface for Cabinets	1	2460640000*
IE-FCM-RJ45-C	Service Interface for Cabinets	1	1018790000
IE-PS-RJ45-FH-BK	RJ45 IP20 Connector	1	1963600000
IE-TD-RJ45-C	Outlet for Cabinet	1	8946920000
IE-C6FP8LD0002M40M40-D	Patchcord	1	1165940002
Note	* not yet UL/UR approved		



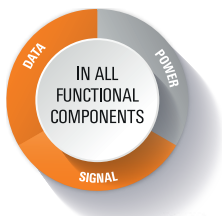

## I/O systems for battery storage applications

For future-oriented Industry 4.0 inside and outside the electrical cabinet, Weidmüller's flexible remote I/O systems offer automation at it's best. u-remote from Weidmüller forms a reliable and efficient interface between the control and field levels. The I/O system impresses with its simple handling, high degree of flexibility and modularity as well as outstanding performance. The two I/O systems UR20 and UR67 cover all common signals and fieldbus/network protocols in automation technology.



For further products, information, technical specifications or additional services, please visit our website:  
[www.weidmueller.com/u-remote](http://www.weidmueller.com/u-remote)



### Fieldbus coupler

Type	Version	Qty	Order No.
UR20-FBC-PN-IRT-V2	Remote I/O fieldbus coupler, IP20, Ethernet, PROFINET IRT	1	2566380000
UR20-FBC-PB-DP-V2	Remote I/O fieldbus coupler, IP20, PROFIBUS DP-V1	1	2614380000
UR20-FBC-EC	Remote I/O fieldbus coupler, IP20, Ethernet, EtherCAT	1	1334910000
UR20-FBC-MOD-TCP-V2	Remote I/O fieldbus coupler, IP20, Ethernet, Modbus/TCP	1	2476450000
UR20-FBC-EIP	Remote I/O fieldbus coupler, IP20, Ethernet, EtherNet/IP	1	1334920000
UR20-FBC-CAN	Remote I/O fieldbus coupler, IP20, CANopen	1	1334890000
UR20-FBC-DN	Remote I/O fieldbus coupler, IP20, DeviceNet	1	1334900000
UR20-FBC-CC	Remote I/O fieldbus coupler, IP20, CC-Link	1	2625010000
UR20-FBC-CC-TSN	Remote I/O fieldbus coupler, IP20, CC-Link IE TSN	1	2680260000
UR20-FBC-PL	Remote I/O fieldbus coupler, IP20, Ethernet, POWERLINK	1	1334940000
UR20-FBC-IEC61162-450	Remote I/O fieldbus coupler, IP20, Ethernet, IEC 61162-450	1	2661310000



### Modules

Type	Version	Qty	Order No.
<b>Digital input modules</b>			
UR20-4DI-P	Remote I/O module, IP20, Digital signals, Input, 4-channel	1	1315170000
UR20-8DI-P-2W	Remote I/O module, IP20, Digital signals, Input, 8-channel, 2-conductor connection	1	1315180000
UR20-16DI-P	Remote I/O module, IP20, Digital signals, Input, 16-channel	1	1315200000
UR20-4DO-P	Remote I/O module, IP20, Digital signals, Output, 4-channel	1	1315220000
UR20-4DO-P-2A	Remote I/O module, IP20, Digital signals, Output, 4-channel, 2 A per channel	1	1315230000
UR20-8DO-P	Remote I/O module, IP20, Digital signals, Output, 8-channel	1	1315240000
UR20-16DO-P	Remote I/O module, IP20, Digital signals, Output, 16-channel	1	1315250000
UR20-8DI-P-3W	Remote I/O module, IP20, Digital signals, Input, 8-channel	1	1394400000
<b>Analogue input modules</b>			
UR20-4AI-UI-16	Remote I/O module, IP20, 4-channel, Analog signals, Input, Current/Voltage, 16 Bit	1	1315620000
UR20-4AI-HART-16-DIAG	Remote I/O module, IP20, Analog signals, Input, 4-channel, HART®	1	2617520000*
<b>Analogue output modules</b>			
UR20-4AO-UI-16	Remote I/O module, IP20, Analog signals, Output, 4-channel, Current/Voltage	1	1315680000
UR20-2AO-UI-16	Remote I/O module, IP20, Analog signals, Output, 2-channel, Current/Voltage	1	2705630000*
<b>Temperature modules and potentiometer input module</b>			
UR20-4AI-RTD-DIAG	Remote I/O module, IP20, Analog signals, Temperature, RTD	1	1315700000
UR20-4AI-TC-DIAG	Remote I/O module, IP20, Analog signals, Temperature, TC	1	1315710000
<b>Power-feed modules</b>			
UR20-PFI	Remote I/O module, IP20, Power supply unit, 24 VDC-Input	1	1334710000
UR20-PFO	Remote I/O module, IP20, Power supply unit, 24 VDC-Output	1	1334740000
<b>Safe I/O modules and safe power-feed modules</b>			
UR20-4DI-4DO-PN-FSPS-V2	Remote I/O module, IP20, Safety, Digital signals, 4-channel	1	2464570000
UR20-8DI-4DO-PN-FSPS-V2	Remote I/O module, IP20, Safety, Digital signals, 8-channel	1	2464590000
<b>Digital counter- and communication- modules</b>			
UR20-1COM-232-485-422-V2	Remote I/O module, IP20, 1-channel, RS232/RS485/RS422 communication, PUSH IN connection	1	2826800000*
<b>Note</b>	* not yet UL/UR approved		



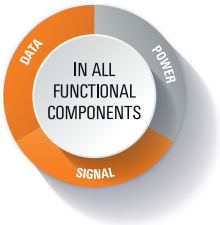

### Controllers for battery management systems (BMS)

For modern IoT applications, automation technology needs to be increasingly more powerful and adaptable. u-mation offers a coordinated hardware portfolio designed for the future-proof preparation of your machines and systems. u-control 2000 is one of the most compact and state-of-the-art control systems on the market and is the centrepiece of our hardware portfolio. u-control 2000 forms the basis required for use of our engineering solutions u-create web, studio and IoT.

With u-control M3000, automation solutions can be perfectly integrated into the IoT. The powerful controller also works as an edge device for providing local information in the network and can be expanded by connecting function modules – ideal for automation and IIoT applications. u-control M4000 offers two additional CPU cores, two additional Ethernet interfaces and more RAM, NV RAM, and flash memory for complex edge computing in automation.

The controllers modular design is based on the remote I/O system u-remote, and allows for needs-based expansion to include other components from the u-mation family.



For further products, information, technical specifications or additional services, please visit our website: [www.weidmuller.com/controls](http://www.weidmuller.com/controls)



#### u-control

Type	Version	Qty	Order No.
<b>for standard applications</b>			
UC20-WL2000-AC	Controller, IP20, AutomationController, Web-based, u-control 2000 web, integrated engineering tools: u-create web for PLC - (real-time system) & IIoT applications and CODESYS (u-OS) compatible	1	1334950000
UC20-WL2000-AC-CAN	Controller, IP20, AutomationController, Web-based, u-control 2000 web, CAN interface, integrated engineering tools: u-create web for PLC - (real-time system) & IIoT applications and CODESYS (u-OS) compatible	1	2928020000*
<b>for high-performance applications</b>			
UC20-M3000	Controller, IP20, AutomationController, Web-based, u-control M3000, integrated engineering tools: IIoT applications and CODESYS (u-OS)	1	2839150000*
UC20-M4000	Controller, IP20, AutomationController, Web-based, u-control M4000, integrated engineering tools: IIoT applications and CODESYS (u-OS)	1	2839160000*
<b>Note</b>	* not yet UL/UR approved		



# Hydrogen

Hydrogen	Introduction	D.2
	Weidmüller Solutions for Electrolysis & Fuel Cell Stacks	D.6
	Solutions for Electrolysis	D.8
	Solutions for Hydrogen Refuelling Stations	D.10
	Cell Voltage Measurement Box	D.16
	High-performance components	D.20
	Success Story Sonepar	D.38
	Success Story Reverion	D.40



# Hydrogen: The energy source of the future

## Sustainable transformation of energy and industrial processes

The expansion of hydrogen is crucial for the sustainable transformation of our energy and industrial systems. It opens up new opportunities to lower emissions and decrease our reliance on fossil fuels. To fully harness hydrogen as the energy carrier of the future, one crucial factor is essential: the efficiency of the plants.

### D

Optimising plant efficiency means not only reducing costs, but also increasing performance and resource conservation along the entire value chain – from hydrogen production to storage and utilisation. Weidmüller’s specialised expertise in products and certifications helps to increase your plant efficiency.



### Customised certification and industrialisation for the hydrogen ramp-up

With our extensive experience in the process industry and and the certificaton of products and processes we develop safe and forward-looking solutions together.

- Certification expertise
- Approvals for hazardous areas
- Development expertise





## Electrolysers and fuel cells

Electrolysis is the key process in hydrogen production, whereby various technologies have been developed to meet the different requirements of use and energy demand. From alkaline electrolysers to proton exchange membranes (PEM), anion exchange membranes (AEM) through to solid oxide electrolysis cells (SOEC), each type of electrolysis offers specific advantages. At Weidmüller we have extensive experience with all of these hydrogen technologies and offer customised solutions in electrical connectivity and automation to support efficient and reliable hydrogen production and utilisation worldwide.



More information on our website:  
[www.weidmueller.com/h2electrolysis](http://www.weidmueller.com/h2electrolysis)

D



## Refuelling stations and storage

Hydrogen storage and refuelling stations require seamless integration of different systems, from trailer swap and compression to refrigeration, dispensers and other components. All of these components must interact flawlessly to ensure efficient and safe operation. Weidmüller's modular approach enables customers to develop fully customised connectivity and automation systems. With our flexible and scalable solutions, every aspect of the storage and refuelling process can be optimised to ensure smooth operation and easy adaptation to future requirements.



More information on our website:  
[www.weidmueller.com/h2refuelling](http://www.weidmueller.com/h2refuelling)

# More efficiency in hydrogen production

## Solutions for electrolysers

D

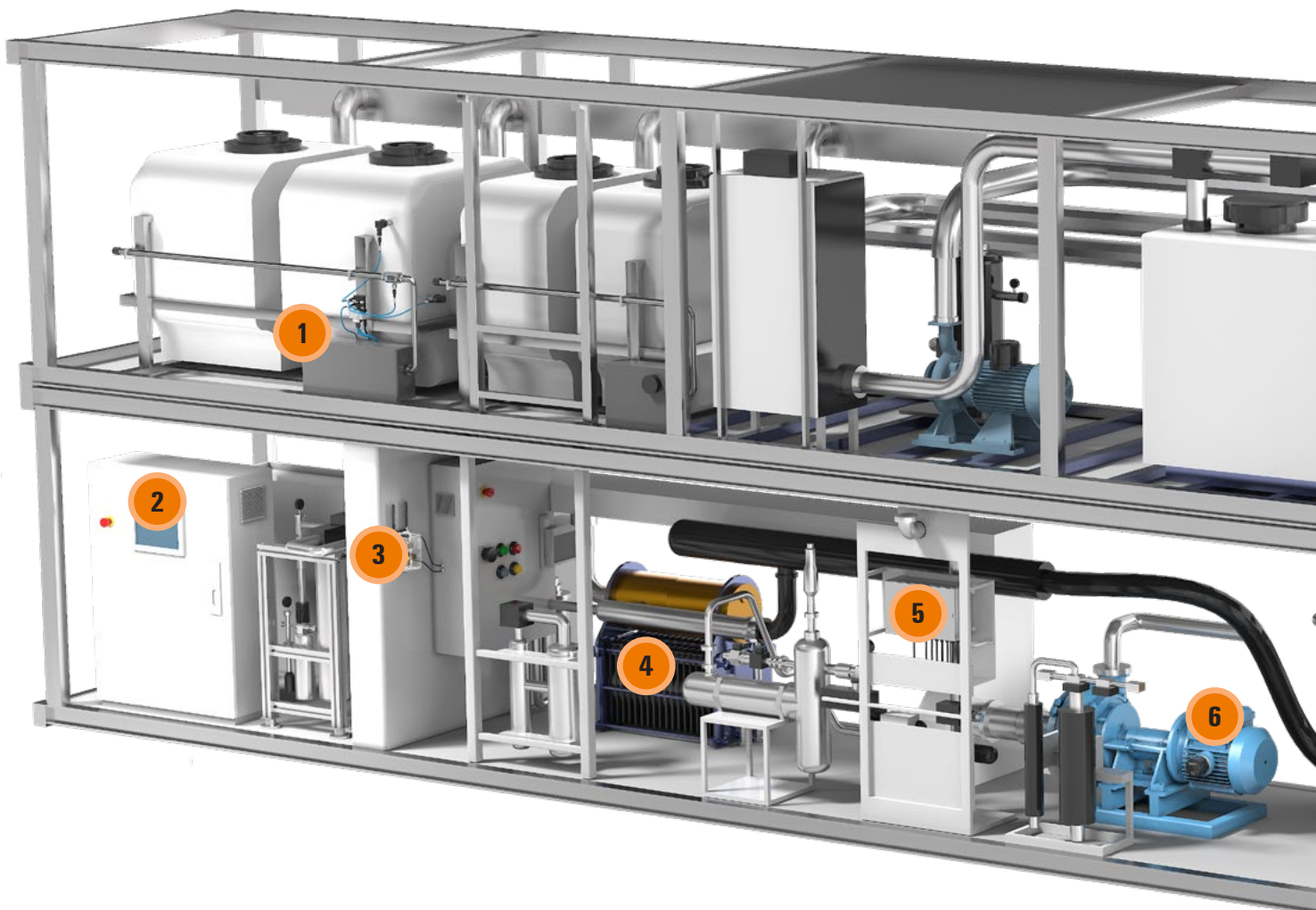

An electrolysis system consists of several interconnected modules, including transformers, rectifiers, circulation pumps, heat exchangers, stack coolers, dryers and compressors. Each of these is essential for the smooth and efficient operation of the entire process.

In addition to seamless integration, the system must be fully automated and fulfil strict safety certifications such as ATEX and SIL2/SIL3. With expertise in electrical connectivity, automation, hardware and software, Weidmüller offers comprehensive solutions for all these systems to ensure safe and efficient operation.

## Cell Voltage Measurement Box

Cell voltage measurement for stacks: electrolyser, fuel cells and BESS



The Cell Voltage Measurement Box (CVM) enables the measurement of the differential voltage of individual cells in electrolysis stacks, fuel and battery cells to collect and analyse data of hydrogen systems.

It can be used independently of the manufacturer and fulfils all requirements of the hydrogen industry, including the necessary certifications. The special feature: The box is plug-and-play ready, modular and designed for industrialisation and a rapid ramp-up of the H<sub>2</sub> industry, electrolysers and fuel cells.



More information on our website:  
[www.weidmuller.com/cvm-box](http://www.weidmuller.com/cvm-box)

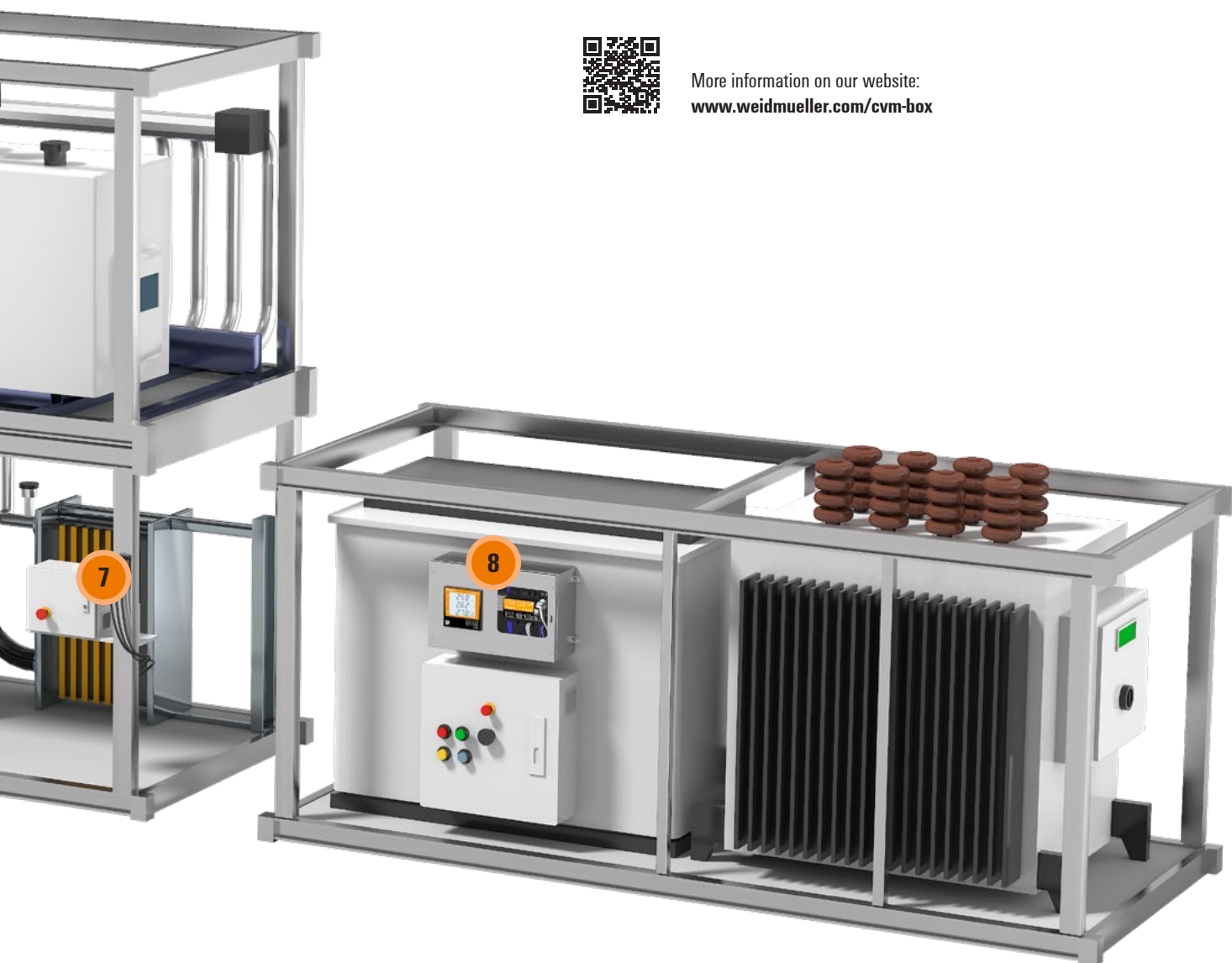

## Our solutions for electrolyzers in detail



## 1. Sensor/actuator connectivity

Sensor/actuator connectivity is crucial for modern automation solutions. **Decentralised contacting** enables flexible and efficient systems that facilitate installation and maintenance. With a high level of protection, the components are optimally shielded from environmental influences, enhancing their longevity. The plug-and-play capability ensures quick integration into existing systems without extensive configurations. The **ATEX certification** for zones 1 and 2 ensures safe use in potentially explosive areas. Additionally, the M12 sensor cable connection enhances the robustness and reliability of the applications.



## 2. Control cabinet

The fast delivery of individually pre-assembled, equipped and ready-to-install mounting rails and cable harnesses simplifies and accelerates the production process. In this way, our customers reduce their costs and increase their flexibility and competitiveness. With the **Weidmüller Configurator (WMC)** software, users can make individual configurations for their control cabinet.



## 3. Data communication

Communication for controlling systems is crucial for smooth operation. Technicians can access systems at any time via **remote maintenance**, enabling problems to be solved quickly. A Universal edge gateway with LTE/4G connection ensures stable data transmission. Node-RED is used for visual programming to manage data streams and optimise automation processes. A **security router** protects the traffic and prevents unauthorised access, which ensures efficient, secure and flexible control of industrial plants.

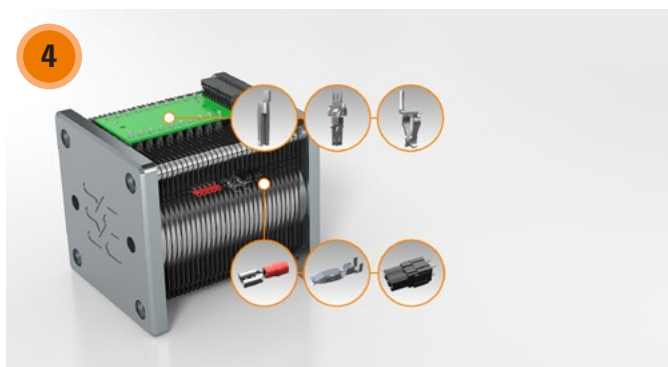

## 4. Contact technology for electrolysis stacks

In addition to individual contacts, customised designs are also possible. The contacts are assembled into an interface board, enabling **multiple connections** to the bipolar plates and, if necessary, fusing. The temperature-related expansion and the production tolerances of the stack must be taken into account. Compared to single contacting, the interface solution offers significant time savings and error reduction in stack production. A customised cable assembly completes the offering and prepares the analysis of cell voltages.

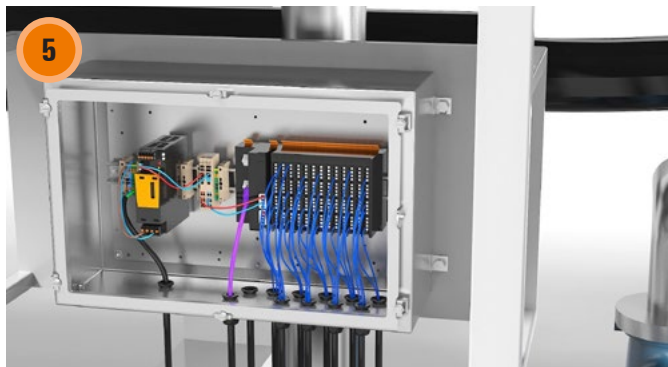

## 5. Data acquisition for electrolysis stacks

**Ex-certified components** ensure that devices and systems meet the highest safety standards. This certification guarantees data security and reliability. Thanks to modularity and scalability, our customers can flexibly adapt the data collection and efficiently integrate new technologies. The industrial quality of the components ensure a long service life and high performance, which minimises downtimes and maximises productivity. **Condition monitoring** allows for continuous machine oversight, enabling early detection and resolution of potential issues, thereby increasing operational efficiency.

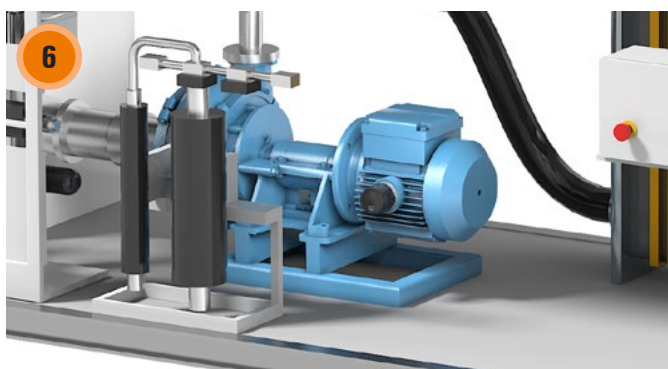

## 6. Vibration monitoring

Our sensor measuring systems offer a comprehensive solution for **all sensor types** and are designed to ensure maximum precision and flexibility. They can be used universally, support a wide range of sensor types and can be precisely tailored to the application thanks to configurable measuring spans. The galvanic isolation offers safety combined with high measuring accuracy in **Ex and non-Ex areas**.

These features make our measuring systems a first-class choice for demanding measurement technology in hydrogen applications

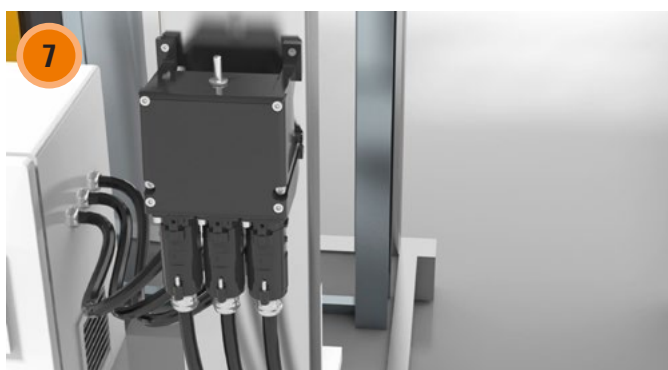

## 7. High-current connector

The RockStar® HighPower modular high-current connector system has been specially developed for the transmission of high electrical power. The **modular design** consists of one-piece crimp contacts, insulating sleeves, insert holder frames and a robust, multi-part, dust and waterproof die-cast aluminium housing (IP68) and cross-connection options. The modular design offers clear advantages for handling.



## 8. Energy management

Energy management plays a central role in optimising processes and reducing costs. With ResMa®, an innovative approach to resource and energy management, companies can significantly enhance their energy efficiency. The **DIN EN ISO 50001** standard provides a structured framework for energy management. Another advantage is the ability to analyse processes easily and efficiently, particularly through the use of human-machine interfaces (HMI). These technologies enable intuitive monitoring and control of energy consumption and production.



## Solution design: Stack monitoring for electrolysers and fuel cells

The stack is one of the most important components in hydrogen production and is crucial for efficiency and safety. As a pioneer in 'From data to value', Weidmüller offers end-to-end solutions from connectivity to the the cloud. Weidmüller monitors key parameters such as the total applied current

and voltage, temperature, the preload force caused by disc springs and vibrations caused by compressors and pumps. By recording and analysing this data, we ensure optimised performance, early fault detection and increased operational reliability of the stack.

D



Zone 1/2

**Data acquisition**

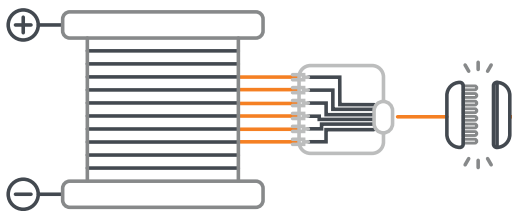

Zone 1/2

**Data pre-processing & control**

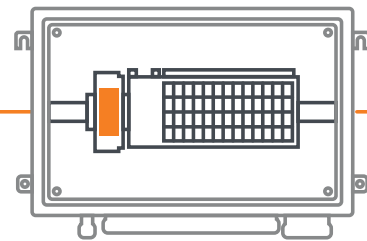

Fieldbus communication via:

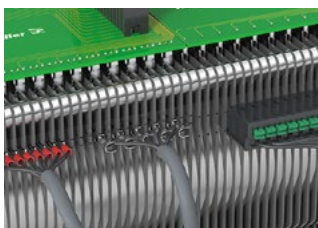

### Individual contacting

With our wide range of contacting options we offer professional individual contacting of the bipolar plates in the stack.



### Multiple contacting

In addition to single connections are also possible. The contacts are applied to the printed circuit boards so that several circuit boards can be contacted in a single plugging process. For the typical stacks of PEM electrolysis, this means a considerable time saving.



### Data pre-processing

Differential voltage measurement of individual cells for data acquisition and analysis. Our CVM Box is plug-and-play, modular and suitable for industrialisation. It supports protocols such as PROFINET, EtherCAT, Modbus and many other options that are available without protocol converters are available.



### Data control

At the same time, the data acquisition of the differential voltage measurement of individual cells can be combined. With the help of the u-control product family, a large number of cell voltages can be measured and monitored. Subsequently, control functions and data analysis can be triggered.

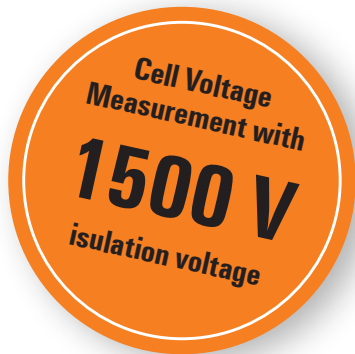

**Monitoring Options**

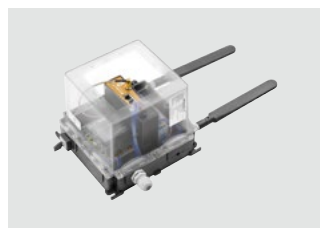
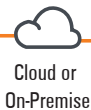
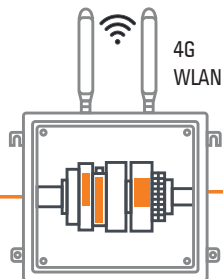
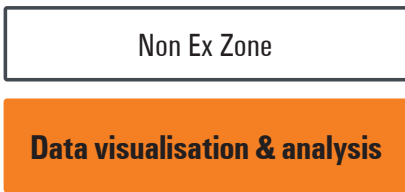
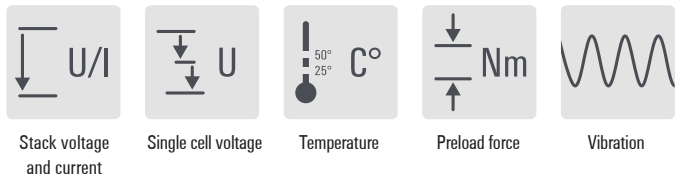

**Local communication**  
In addition to the LAN connection, a connection via IoT boxes is also possible. This allows stationary systems to be accessed remotely.



**IIoT data communication**  
In addition to the system operator, the stack manufacturer can also access the system remotely for diagnostics, service and support. This enables preventive maintenance and maximises the operational time of the system.



**Data visualisation and analysis**  
With our visualisation hardware u-view and software solution PROCON-WEB we enable real-time data acquisition of stacks. This allows manufacturers and operators to monitor important parameters and and recognise potential errors.



**Data analysis and machine learning**  
Our integrated approach ensures seamless data flow from the stack to the cloud, which can be utilised for automated machine learning. By integrating edgeML into PROCON-Connect, the results of the models can be transmitted to HMI and SCADA applications, for example, where they can trigger alarms or be transferred to the cloud of operators and manufacturers via MQTT.

# Efficient hydrogen distribution

## Solutions for storage and refuelling stations

D

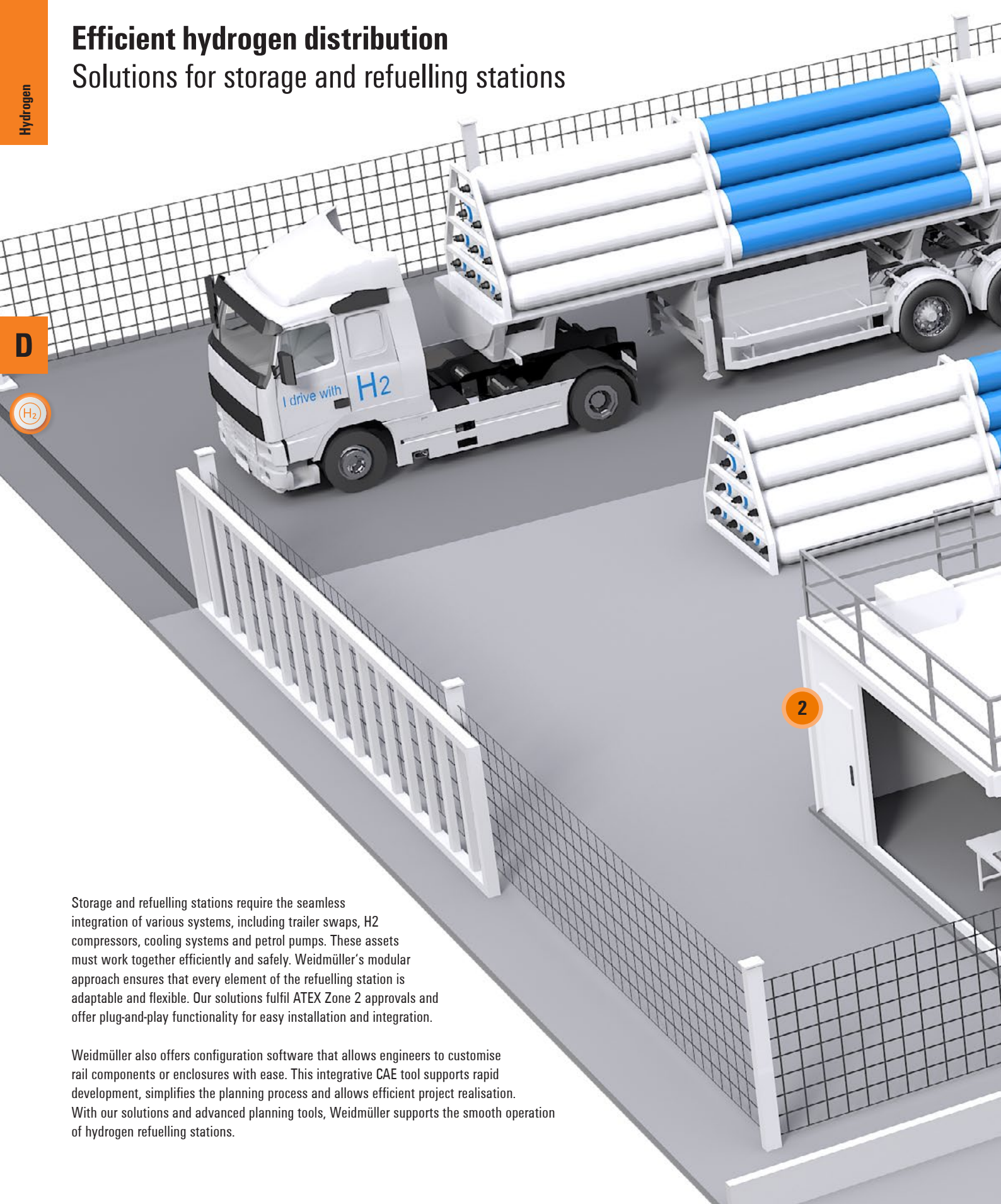

Storage and refuelling stations require the seamless integration of various systems, including trailer swaps, H2 compressors, cooling systems and petrol pumps. These assets must work together efficiently and safely. Weidmüller's modular approach ensures that every element of the refuelling station is adaptable and flexible. Our solutions fulfil ATEX Zone 2 approvals and offer plug-and-play functionality for easy installation and integration.

Weidmüller also offers configuration software that allows engineers to customise rail components or enclosures with ease. This integrative CAE tool supports rapid development, simplifies the planning process and allows efficient project realisation. With our solutions and advanced planning tools, Weidmüller supports the smooth operation of hydrogen refuelling stations.

'Plug&Play' solutions  
for ATEX zones

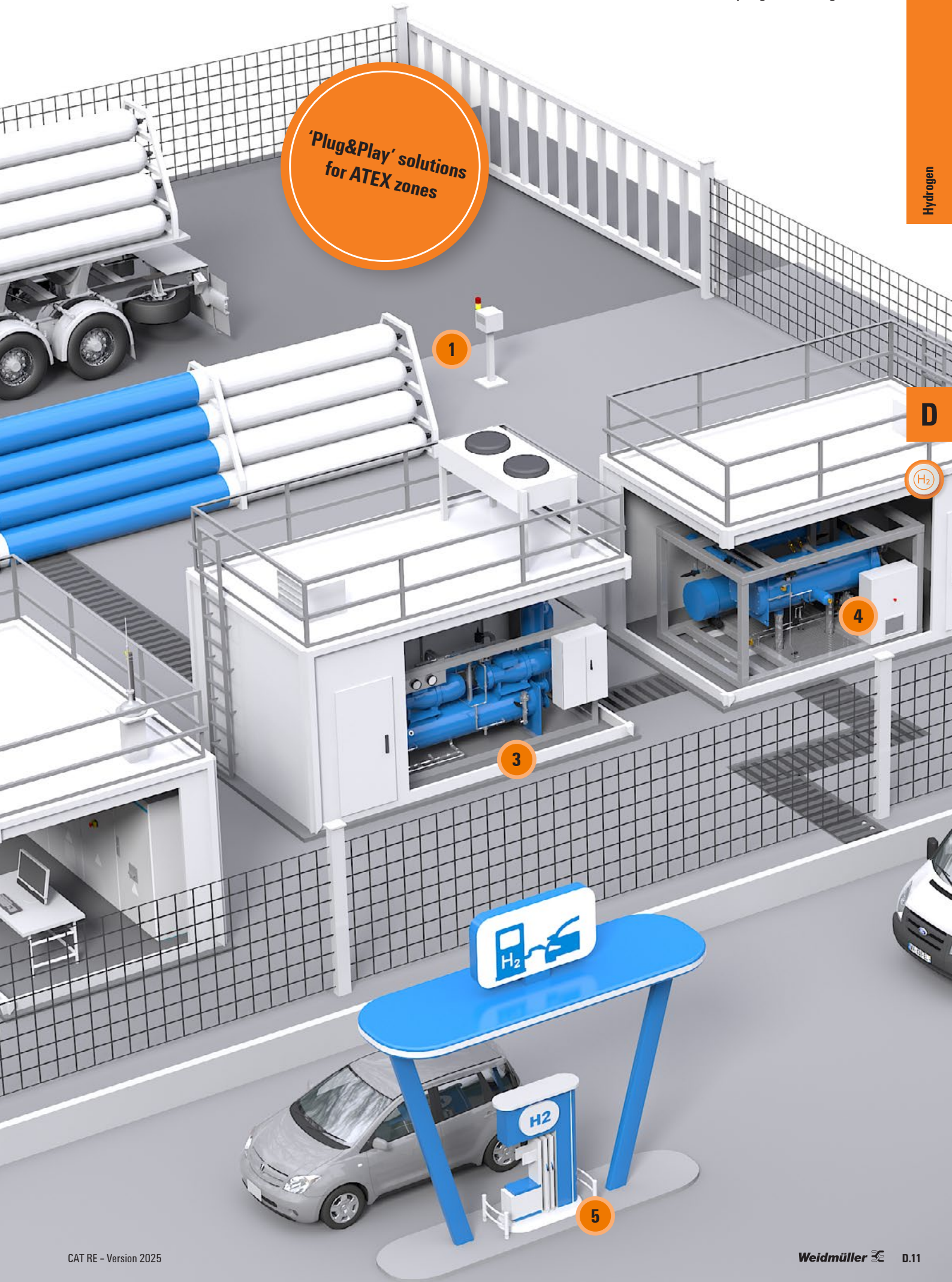

## Our solutions for hydrogen refuelling stations in detail

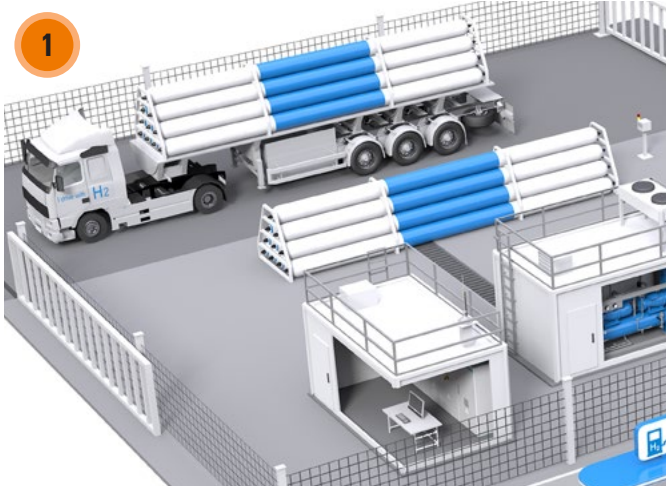

### 1. Storage

Important components are the **communication boxes**, which ensure reliable data transmission for the control and monitoring of storage in warehouses or trailers. An ATEX-certified heating system is required to comply with safety standards in potentially explosive areas and to regulate the temperature of the hydrogen tanks, which increases operational safety. **Heavy-duty connectors** ensure robust and safe connections between the components, while backup enclosures allow flexible adjustments to the refuelling station infrastructure to facilitate future expansions.

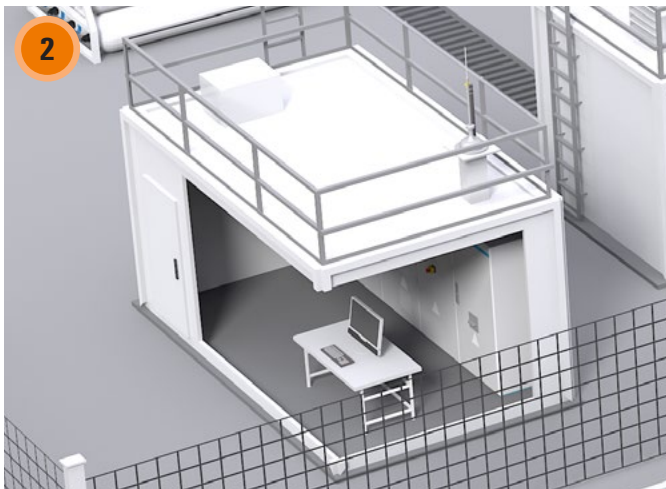

### 2. Control room

The control room is central to operational monitoring and control. With a **modular control unit**, operators can react flexibly to requirements and adapt the systems efficiently. Modular remote I/O systems make it easy to expand the infrastructure. A web-based **SCADA system** provides remote access, allowing operators to access data at any time, thereby shortening response times in the event of faults. **Industrial Analytics** provides valuable insights into operating data to increase efficiency and detect problems at an early stage. The ResMa<sup>®</sup> energy management system ensures optimised use of resources. Fieldbus distribution and the Industrial Ethernet portfolio guarantee robust data communication.

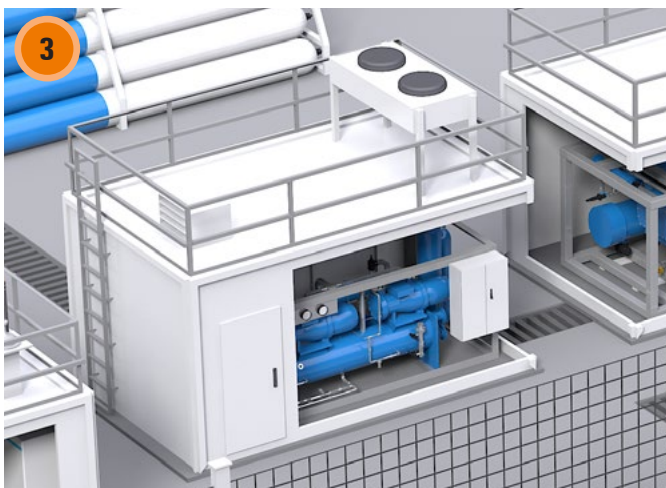

### 3. Compressor

A modular control unit enables flexible adaptation of operating parameters and integration into existing systems. **Modular remote I/O systems** ensure efficient data processing, while ATEX-certified housings guarantee safety in potentially explosive atmospheres. Intrinsically safe, analogue signal processing and HART<sup>®</sup> repeaters enable precise monitoring of the compressors. Solutions from the Industrial Ethernet portfolio offer robust data communication. Industrial Analytics provides insights into operating data to increase efficiency and early detection of problems. Relay couplers and solid state relays ensure reliable control of electrical components, while distribution boxes and junction boxes simplify cabling. **Sensor distribution blocks (Ex i)** and sensor cables ensure safe connections to the measuring systems.

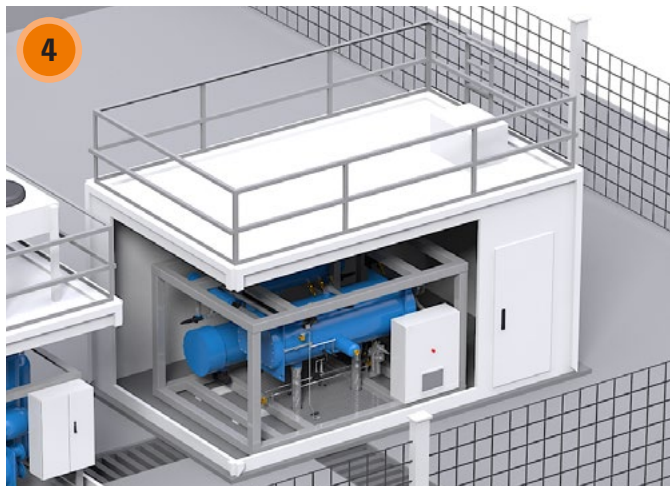

#### 4. Cooling unit

Refrigeration units are essential for the safe storage and handling of hydrogen at refuelling stations. A modular control unit enables flexible adaptation to different operating conditions. Modular remote I/O systems and a DC emergency power supply (UPS) ensure efficient monitoring and reliable operation. Our PROtop power supply with **I/O link communication** further increases operating efficiency. Electronic load monitoring protects against overloads, while relay couplers and solid-state relays ensure safe control of the electrical systems. Data communication provides real-time information to further enhance operating efficiency.



#### 5. Refuelling

The dispenser unit in the hydrogen refuelling station is crucial for a safe and efficient refuelling process. **Touch panels** facilitate the user-friendly monitoring and control of the entire refuelling process in real time. **Industrial PCs** play a central role in the filling unit, enabling powerful data processing and analysis. Additionally, control and signaling devices ensure precise control of the filling processes and optimal parameter settings. Another important aspect are the **safety relays**, which act as a protective mechanism. They monitor critical functions and ensure that immediate action is taken in the event of an error to safeguard users and system.

# Solution design: Monitoring of hydrogen storage and refuelling

Weidmüller's technology optimises hydrogen filling stations through holistic data management solutions - from acquisition to analysis. Our innovations not only increase operational efficiency, but also ensure compliance with the highest safety standards and promote a sustainable energy future.

Thanks to our expertise in connectivity and automation we enable efficient and safe management of the hydrogen infrastructure.

D



**Ex** Zone 1/2

**Data acquisition**

**Ex** Zone 2

**Data pre-processing & control**

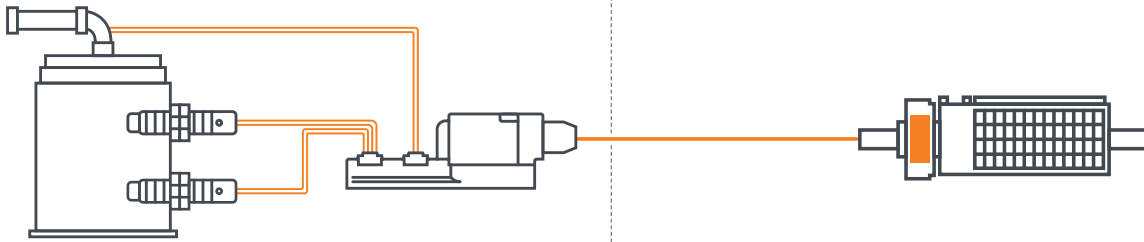

**Ex-protected junction box**  
Hydrogen refuelling stations require different solutions for various applications. With our Klippon® installation service we provide ready-to-connect enclosure solutions for a wide range of applications, creating significant process savings, while we fulfil the highest quality and standard requirements.



**Ex-protected SAI block**  
Various sensor information must be collected from potentially explosive hazardous areas. From sensors for flow measurement to temperature and much more. The ATEX and IECEx-certified SAI distribution box from Weidmüller is used in explosion-protected areas for the transmission of intrinsically safe circuits up to and including Zone 1.



**Pre-processing of the data**  
All sensor information from the field can be easily collected via the u-remote series and transmitted to the control system in real time using protocols such as PROFINET, EtherCAT or others. The integrated web server also facilitates the setup of the I/O system. The u-remote system is Zone 2 Ex approved and can be integrated into Ex environment solutions.



**Data control**  
The powerful controller also functions as an edge device and provides local information on the network. It can be expanded by connecting function modules, which makes it ideal for automation and IIoT applications. Thanks to its capabilities, u-control can be used for dynamic cooling management to reduce energy consumption. All u-remote modules, such as the energy module, are supported.



Non Ex Zone

Data communication

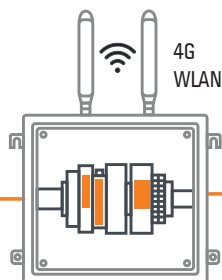

Non Ex Zone

Data visualisation & analysis



Cloud or On-Premise



**Local Communication**

Thanks to a wide range of Ethernet solutions, serial dispenser communication protocols (e.g. RS-232, RS-422, RS-485) can be converted into an Ethernet-based network. Weidmüller also offers managed and unmanaged switches for smooth communication. This enables reliable and flexible transmission of data between devices such as compressors, cooling systems or storage tanks in the network.



**Cloud Communication**

Remote access is one of the most important aspects for security. Thanks to the integrated firewall and VPN technology, secure data communication via the Weidmüller security router is possible. The router meets the required certifications and standards for hydrogen refuelling stations.



**Data analysis with ResMa®**

ResMa® is the Weidmüller resource management software. It can be easily integrated into refuelling stations to enable simple data collection from different dispensers and systems as well as the collection of production data. This data can be used to calculate the amount of H2 or to determine the energy consumption of devices such as compressors and cooling units.



**Data management and industrial AI**

The data from the PLC can be directly fed into the PROCON-WEB SCADA system. Third-party data, such as weather forecasts, can be easily integrated to predict scenarios and ensure the smooth operation of the system. edgeML enables the local execution of machine learning models, allowing maintenance intervals to be optimized and quality assurance measures to be implemented, for example.

# Cell Voltage Measurement Box – Safe stack condition monitoring

## Cell voltage measurement for stacks: electrolyser, fuel cells & BESS

Our Cell Voltage Measurement Box (CVM) enables safe stack condition monitoring in hydrogen systems. It enables the differential voltage measurement of individual cells for electrolysis stacks, fuel and battery cells for data collection and analysis. It is compatible with manufacturer and fulfils all customer requirements in the hydrogen industry, including the necessary certifications.

D



- Plug-and-play ready, modular and ideally suited for industrialisation and a rapid ramp-up of the H2 industry
- CE-certified, quick and easy to connect
- Increases system efficiency by reliably monitoring the differential voltage of the individual cells
- Technical status can be viewed at any time, service and maintenance can be planned in advance



### Technical data

Number of analogue inputs	4
Resolution	16 Bit
Input parameter	Voltage U (0...5 V, ± 5 V, 0...10 V, ± 10 V, 1...5 V, 2...10 V)
Single channel diagnostics	Ja
Precision	0.1 % FSR
Module diagnostics	Yes
Transformation time	1 ms
"Fieldbus protocol options: PROFINET 8 is used in the product"	PROFINET IRT, PROFINET RT, PROFIBUS DP-V1, EtherCAT, Modbus/TCP, Ethnet/IP, CANopen, DeviceNet, POWERLINKm CC-Link, CC-Link IE TSN
Galvanic isolation	DC 500 V between the inputs
Process data	8 Byte
Transmission rate system bus, max.	48 Mbit
Operating temperature	-20 °C...+60 °C

**Tailor-made customized variants possible for different cell numbers thanks to the wide range of Weidmüller**

**CVM PLC 100 CABTITE PSU 24V**

- Flexible cable entry systems with Cabtite
- Including Power supplies
- Programming via CODESYS
- Polyester Enclosure for Industrial Usage



**CONDITION MONITORING BOX IO 100EX**

- Built for ATEX Zone 2 environment
- Reserve module for expansion with additional sensors
- Cable glands for cable entries
- Individual pre-configured Cable lengths

**CVM IO 160 HDC**

- PROFINET Communication
- Cabling & markers installed
- Ready for cable harness connection

**Cell Voltage Measurement Box – Ordering data**

**Plug and Play ready-made monitoring boxes**

POK industry enclosures with WL2000 controller, with 24V power supply prepared for 100 cells. Customised wiring by the customer possible thanks to Cabtite entries

**CVM PLC 100 CABTITE PSU 24V**

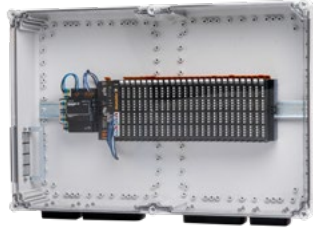

Illustration similar

**Technical data**

**General data**

Version  
Material  
Surface finish  
Protection degree  
Colour  
Humidity  
Height x Width x Depth  
Operating temperature

AutomationController  
PC-ABS  
untreated  
IP66  
Light Grey  
10% to 95%, non-condensing as per DIN EN 61131-2  
400 x 600 x 132 mm  
-20 °C...60 °C

**Rated data acc. to IEC**

Rated current, max. number of poles (Tu=20°C)  
Rated voltage for surge voltage class / pollution degree II/2

10 A  
500 V

Note:

**Ordering data**

Note:

Type	Qty.	Order No.
CVM PLC 100 CABTITE PSU 24V	1	8000142794

**Plug and Play ready-made monitoring boxes**

POK industrial housing with UR-Profinet coupler, wired to 2x HDC 80-pin output for 160 cells.

**CVM IO 160 HDC**

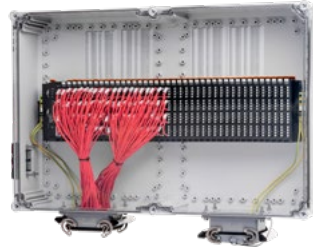

Illustration similar

**Technical data**

**General data**

Version  
Material  
Surface finish  
Protection degree  
Colour  
Humidity  
Height x Width x Depth  
Operating temperature

Voltage monitoring  
PC-ABS  
untreated  
IP65  
Light Grey  
10% to 95%, non-condensing as per DIN EN 61131-2  
400 x 600 x 132 mm  
-20 °C...60 °C

**Rated data acc. to IEC**

Rated current, max. number of poles (Tu=20°C)  
Rated voltage for surge voltage class / pollution degree II/2

10 A  
500 V

Note:

**Ordering data**

Note:

Type	Qty.	Order No.
CVM IO 160 HDC	1	8000140778

**Plug and Play ready-made monitoring boxes**

316L Ex enclosure with UR-Profinet coupler, wired on 4x 25-pin cable 5m led out of the enclosure for 100 cells, plus 5 spare modules for individual addition, e.g. with PT100 modules or others. Sealing plugs prepared for additional wiring.

**CONDITION MONITORING BOX IO 100EX**



**Technical data**

General data	
Version	
Material	
Surface finish	
Protection degree	
Colour	
Humidity	
Height x Width x Depth	
Operating temperature	
Rated data acc. to IEC	
Rated current, max. number of poles (Tu=20°C)	
Rated voltage for surge voltage class / pollution degree II/2	
<b>Note:</b>	

Stainless steel housing, flange plates: bottom
Stainless steel 1.4404 (316 L)
electropolished
IP66
silver
450 x 620 x 200 mm
-20 °C...40 °C
10 A
500 V

**Ordering data**

<b>Note:</b>
--------------

Type	Qty.	Order No.
CONDITION MONITORING BOX IO 100EX	1	8000140773

**Accessories**

5 m connection cable

**HDC CABLE ADAPTATION 80.POL**



**Technical data**

General data	
Version	
Number of poles	
Protection degree	
Diameter	
Length	
Limit temperature	
<b>Note:</b>	

Pin, straight – Socket, straight
80
IP65
17.4 mm
10 mm
-15 °C ... 80 °C

**Ordering data**

<b>Note:</b>
--------------

Type	Qty.	Order No.
HDC KABELADAPTION 80.POL	1	8000140763





## Terminal blocks – Klippon® Connect

### SNAP IN technology:

The fastest, safest and easiest connection for hydrogen applications. With the innovative Weidmüller SNAP IN technology makes connecting terminal simpler. Experience time-saving connections with visual and acoustic noise make error-free installations. Our diverse product range also ensures the efficiency and reliability of your hydrogen applications.

Rely on SNAP IN for strong performance, safety and simplification for your hydrogen projects.



For further products, information, technical specifications or additional services, please visit our website:

[www.weidmueller.com/terminal-blocks](http://www.weidmueller.com/terminal-blocks)



### S-Series – SNAP IN technology

Type	Version	Qty	Order No.
S2C 2.5	Feed-through terminal, SNAP IN, 2,5 mm <sup>2</sup> , 800 V, 24 A, dark beige	100	2674530000
S3C 2.5	Feed-through terminal, SNAP IN, 2,5 mm <sup>2</sup> , 800 V, 24 A, dark beige	100	2674540000
S4C 2.5	Feed-through terminal, SNAP IN, 2,5 mm <sup>2</sup> , 800 V, 24 A, dark beige	100	2674550000
S2C 4	Feed-through terminal, SNAP IN, 4 mm <sup>2</sup> , 800 V, 32 A, dark beige	50	2874820000
S3C 4	Feed-through terminal, SNAP IN, 4 mm <sup>2</sup> , 800 V, 32 A, dark beige	50	2874840000
S4C 4	Feed-through terminal, SNAP IN, 4 mm <sup>2</sup> , 800 V, 32 A, dark beige	50	2874860000
S2T 2.5	Feed-through terminal, SNAP IN, 2,5 mm <sup>2</sup> , 800 V, 24 A, dark beige	50	2902380000

SNAP IN



### A-Series – PUSH IN technology

Type	Version	Qty	Order No.
A2C 1.5	Feed-through terminal, PUSH IN, 1,5 mm <sup>2</sup> , 500 V, 17,5 A, dark beige	100	1552790000
A3C 1.5	Feed-through terminal, PUSH IN, 1,5 mm <sup>2</sup> , 500 V, 17,5 A, dark beige	50	1552740000
A4C 1.5	Feed-through terminal, PUSH IN, 1,5 mm <sup>2</sup> , 500 V, 17,5 A, dark beige	100	1552690000
A2C 2.5	Feed-through terminal, PUSH IN, 2,5 mm <sup>2</sup> , 800 V, 24 A, dark beige	100	1521850000
AL2C 2.5	Feed-through terminal, PUSH IN, 2,5 mm <sup>2</sup> , 800 V, 24 A, dark beige	100	2847200000
A3C 2.5	Feed-through terminal, PUSH IN, 2,5 mm <sup>2</sup> , 800 V, 24 A, dark beige	100	1521740000

PUSH IN



### W-Series – Clamping yoke technology

Type	Version	Qty	Order No.
WDU 2.5	Feed-through terminal, Screw connection, 2,5 mm <sup>2</sup> , 800 V, 24 A, dark beige	100	1020000000
WDU 4	Feed-through terminal, Screw connection, 4 mm <sup>2</sup> , 800 V, 32 A, dark beige	100	1020100000
WDU 6	Feed-through terminal, Screw connection, 6 mm <sup>2</sup> , 800 V, 41 A, dark beige	100	1020200000
WDU 10	Feed-through terminal, Screw connection, 10 mm <sup>2</sup> , 1000 V, 57 A, dark beige	50	1020300000



### WPD Power Distribution

Type	Version	Qty	Order No.
WPD 130 1X50/1X50 GY	W-Series, Distribution block, Rated cross-section: 50 mm <sup>2</sup> , Terminal rail / mounting plate	9	2502530000
WPD 131 1X95/1X95 GY	W-Series, Distribution block, Rated cross-section: 95 mm <sup>2</sup> , Terminal rail / mounting plate	2	2503090000
WPD 132 1X185/1X185 GY	W-Series, Distribution block, Rated cross-section: 185 mm <sup>2</sup> , Terminal rail / mounting plate	1	2502750000
WPD 133 1X300/1X300 GY	W-Series, Distribution block, Rated cross-section: 300 mm <sup>2</sup> , Terminal rail / mounting plate	1	2502850000



### Klippon® Connect TTB-Range

Type	Version	Qty	Order No.
ATTB 6	Test-disconnect terminal, PUSH IN, 6 mm <sup>2</sup> , 500 V, 30 A, dark beige	50	2710070000
ATTB 6 PE	Test-disconnect terminal PE-version, PUSH IN, 6 mm <sup>2</sup> , 500 V, green-yellow	50	2710080000
WTTB 6	Test-disconnect terminal, Screw connection, 6 mm <sup>2</sup> , 500 V, 30 A, dark beige	50	2710090000
WTTB 6 PE	Test-disconnect terminal PE-version, Screw connection, 6 mm <sup>2</sup> , 500 V, green-yellow	50	2710100000





## SAI Distribution Boxes

Our sensor actuator boxes are equipped with metal threaded rings as standard. This ensures a particularly secure screw connection. The portfolio includes M8 and M12 distribution boxes in plastic and metal. We also develop customised variants according to your individual specifications.



For further products, information, technical specifications or additional services, please visit our website:

[www.weidmuller.com/sensor-actuator-boxes](http://www.weidmuller.com/sensor-actuator-boxes)



### Signal distribution boxes - M12 distribution boxes

Type	Version	Qty	Order No.
SAI-4-M 5P M12 1:1	Hood distributor, M12, 30 V, A-coded, LED: No, LED initiator: No, Wiring type: 1:1	1	1806010000
SAI-8-M 5P M12 OL2	Hood distributor, M12, 30 V, A-coded, LED: No, LED initiator: No	1	1816610000



### Power distributors

Type	Version	Qty	Order No.
SAI-4-M-MVV-M12 1:1	Hood version, M12, 400 V, S-coded, LED: Yes	1	2009620000



### M12 EX distributor - OL2 wiring

Type	Version	Qty	Order No.
SAI-04D-VPPP-5A-M120-OL2-EX	Hood version Ex, M12, 30 V, A-coded, LED: No, LED initiator: No	1	2943810000
SAI-08D-VPPP-5A-M120-OL2-EX	Hood version Ex, M12, 30 V, A-coded, LED: No, LED initiator: No	1	2902930000
SAI-04D-VPHP-5A-M120-OL2-EX	Hood version Ex, M12, 30 V, A-coded, LED: No, LED initiator: No	1	2943800000
SAI-08D-VPHP-5A-M120-OL2-EX	Hood version Ex, M12, 30 V, A-coded, LED: No, LED initiator: No	1	2921130000



### M12 EX distributor for NAMUR sensors

Type	Version	Qty	Order No.
SAI-4-M 4P EXI Z1 OL	Hood version Ex, M12, 30 V, A-coded, LED: No, LED initiator: No	1	1868350000
SAI-8-M 4P EXI Z1 OL	Hood version Ex, M12, 30 V, A-coded, LED: No, LED initiator: No	1	1894380000
SAI-04D-VPHP-2A-M120-NAM-EX	Hood version Ex, M12, 30 V, A-coded, LED: No, LED initiator: No	1	2921100000
SAI-08D-VPHP-2A-M120-NAM-EX	Hood version Ex, M12, 30 V, A-coded, LED: No, LED initiator: No	1	2921120000



### M12 EX distributor - 1:1 wiring

Type	Version	Qty	Order No.
SAI-04D-VPPP-5A-M120-OL2-EX	Hood version Ex, M12, 30 V, A-coded, LED: No, LED initiator: No	1	2943810000
SAI-04D-VPHP-5A-M120-OL2-EX	Hood version Ex, M12, 30 V, A-coded, LED: No, LED initiator: No	1	2943800000



### EX cables

Type	Version	Qty	Order No.
SAIL-M12G-2-3.OUBL	Plug, straight, A-coded, 2 poles, unshielded, 3 m cable length	1	3107950300
SAIL-M12W-2-3.OUBL	Plug, angled, A-coded, 2 poles, unshielded, 3 m cable length	1	3107960300
SAIL-M12G-5-3.OUBL	Plug, straight, A-coded, 5 poles, unshielded, 3 m cable length	1	3107980300
SAIL-M12W-5-5.OUBL	Plug, angled, A-coded, 5 poles, unshielded, 3 m cable length	1	3107990500
SAIL-M12G-2SD3.OUBL	Plug, straight, A-coded, 2 poles, shielded, 3 m cable length	1	3108010300
SAIL-M12W-2SD3.OUBL	Plug, angled, A-coded, 2 poles, shielded, 3 m cable length	1	3108020300
SAIL-M12G-4SD3.OUBL	Plug, straight, A-coded, 5 poles, shielded, 3 m cable length	1	3108030300
SAIL-M12W-4SD3.OUBL	Plug, angled, A-coded, 5 poles, shielded, 3 m cable length	1	3108040300

**Note:** The cable lengths are examples. Many other cable lengths are available on request.





## RockStar® heavy-duty connectors

### Simple installation with SNAP IN & PUSH IN Connection technologies

New technologies pose new challenges. For example increasingly relying on CO<sub>2</sub>-neutral technologies neutral technologies. One of these new forms of generation isis hydrogen production. As this produces explosive gases, it is also necessary to use approved connectors. HDC Rockstar® also offers the right solution here in proven quality.

The heavy-duty connectors were designed for:

- Intrinsically safe circuits
- Limit temperatures from -50 degrees to +120 degrees
- Protection class IP65 in mated condition

The following advantages have been incorporated into the development:

- SNAP IN & PUSH IN connection technologies for quick assembly
- Extended temperature range



For further products, information, technical specifications or additional services, please visit our website:

[www.weidmueller.com/rockstar](http://www.weidmueller.com/rockstar)

### EXI – Plug connector for intrinsically safe circuits

Technical data	
Rated current	max: 5A at 60 degrees ambient temperature T6
Rated voltage (IEC 60079 Part 11)	60 V AC / DC
Protection level	II 2G Ex ib IIC T6 Gb
Approval	EXI, intrinsic safety according to IEC 60079- 11
Conductor connection	0.5... 2.5 mm <sup>2</sup>
Labelling	via material designation and EXI screw connection



Type	Version	Connection technology	Qty	Order No.
<b>HDC connection 6 pole, 5A, 1xM20, IP65</b>				
HDC HE 6 MP EXI	Insert, male	PUSH IN connection	1	3001200000
HDC HE 6 FP EXI	Insert, female	PUSH IN connection	1	3001190000
HDC 06B ALU EXI	Bulkhead housing		1	3001300000
HDC 06B TSLU 1M20G EXI	Hood, Cable Entry sideways		1	3001350000
HDC 06B TOLU 1M20G EXI	Hood, Cable Entry at top		1	3001360000
VG M20 EXI 7-13 CR7J G4	Cable Glands M20, IP68		50	2722250000
<b>HDC connection 10 pole 5A, 1xM20, IP65</b>				
HDC HE 10 MP EXI	Insert, male	PUSH IN connection	1	3001230000
HDC HE 10 FP EXI	Insert, female	PUSH IN connection	1	3001220000
HDC 10B ABU EXI	Bulkhead housing		1	3001310000
HDC 10B TSBU 1M25G EXI	Hood, Cable Entry sideways		1	3001370000
HDC 10B TOBU 1M25G EXI	Hood, Cable Entry at top		1	3001390000
VG M25 EXI 12-17 CR7J G4	Cable Glands M25, IP68		50	2722270000
<b>HDC connection 16 pole, 5A, 1xM25, IP65</b>				
HDC HE 16 MP EXI	Insert, male	PUSH IN connection	1	3001250000
HDC HE 16 FP EXI	Insert, female	PUSH IN connection	1	3001240000
HDC 16B ABU EXI	Bulkhead housing		1	3001320000
HDC 16B TSBU 1M25G EXI	Hood, Cable Entry sideways		1	3001400000
HDC 16B TOBU 1M25G EXI	Hood, Cable Entry at top		1	3001440000
VG M25 EXI 12-17 CR7J G4	Cable Glands M25, IP68		50	2722270000
<b>HDC connection 24 pole, 5A, 1xM25, IP65</b>				
HDC HE 24 MP EXI	Insert, male	PUSH IN connection	1	3001280000
HDC HE 24 FP EXI	Insert, female	PUSH IN connection	1	3001270000
HDC 24B ABU EXI	Bulkhead housing		1	3001330000
HDC 24B TSBU 1M25G EXI	Hood, Cable Entry sideways		1	3001460000
HDC 24B TOBU 1M25G EXI	Hood, Cable Entry at top		1	3001520000
VG M25 EXI 12-17 CR7J G4	Cable Glands M25, IP68		50	2722270000

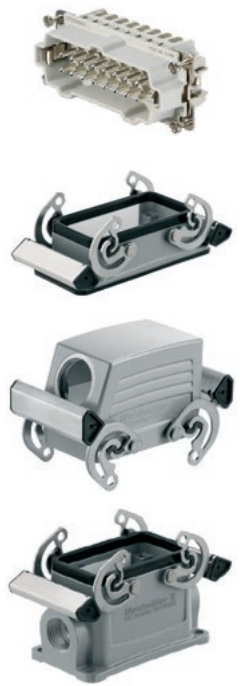

**RockStar® HighPower: the modular 550 A connector**

Type	Rated current	Rated voltage	Conductor cross-section	Number of poles	Version	Qty	Order No.
<b>Bulkhead housing</b>							
HDC IP68 HP 24B A						1	1120040000
<b>Base housing</b>							
HDC IP68 HP 24B AS S						1	1079920000
<b>Plug housing</b>							
HDC IP68 HP 24B TO						1	1079930000
<b>Contact mounting frame</b>							
HDC 24B HP550 MPL2 TYP1				2	Male	1	1103710000
HDC 24B HP550 MPL2 TYP2				2	Female	1	1103770000
<b>550 A Crimp contacts</b>							
HDC HP 550 M 240	550 A	3000 V	240 mm <sup>2</sup>		Male	1	1120590000
HDC HP 550 F 240	550 A	3000 V	240 mm <sup>2</sup>		Female	1	1120600000
<b>Cover for cable glands</b>							
HDC IP68 24B MD 2M40					2xM40	1	1119990000
<b>Cable gland</b>							
VGM40-MS68 20-32 BG					M40	10	1193620000

**RockStar® ModuPlug: Modular connectors with great performance in a reduced installation space****RockStar® ModuPlug: Modular connectors**

Type	Version	Qty	Order No.
<b>Modular connectors, size 8, M32, IP65</b>			
HDC MF 24B AF	Modular insert AF	1	1429050000
HDC MF 24B FA	Modular insert FA	1	1429070000
HDC 24B ADLU	Bulkhead housing	1	1214300000
HDC 64D SDLU 1M32G	Base housing	1	1904440000
HDC 64D TSLU 1M32G	Hood, Cable Entry sideways	1	1786810000

**Data modules - ModuPlug data inserts**

Type	Version	Required plug-in slots	Qty	Order No.
HDC MRJ45 GC	RJ45-RJ45 Gender changer	1	1	2592030000
HDC MRJ45 ABP MI	EIA/TIA-568A, EIA/TIA-568B PROFINET	1	1	2592210000

**Power inserts - ModuPlug power module**

Type	Rated current	Rated voltage	Connection type	Conductor cross-section	Number of poles	Required plug-in slots	Version	Qty	Order No.
HDC MHX 4 MP	40 A	690 A	PUSH IN connection	10 mm <sup>2</sup>	4	1	Male	1	2772810000
HDC MHX 4 FP	40 A	690 A	PUSH IN connection	10 mm <sup>2</sup>	4	1	Female	1	2772800000

**Power Module - ModuPlug power module**

Type	Rated current	Rated voltage	Connection type	Conductor cross-section	Number of poles	Required plug-in slots	Version	Qty	Order No.
HDC MHP 70 FAS	70 A	1000 V	Axial screw connection	25 mm <sup>2</sup>	2	1	Male	2	2748310000
HDC MHP 70 MAS	70 A	1000 V	Axial screw connection	25 mm <sup>2</sup>	2	1	Female	2	2748300000
HDC MHP 100 FAS	100 A	1000 V	Axial screw connection	35 mm <sup>2</sup>	2	2	Male	2	2748290000
HDC MHP 100 MAS	100 A	1000 V	Axial screw connection	35 mm <sup>2</sup>	2	2	Female	2	2748280000
HDC MHP 200 FAS	200 A	1000 V	Axial screw connection	70 mm <sup>2</sup>	1	2	Male	2	2748250000
HDC MHP 200 MAS	200 A	1000 V	Axial screw connection	70 mm <sup>2</sup>	1	2	Female	2	2748240000



Signal modules – ModuPlug signal modules

Type	Rated current	Rated voltage	Connection type	Conductor cross-section	Number of poles	Required plug-in slots	Version	Qty	Order No.
HDC MHE 5 MP	16 A	400 V	PUSH IN connection	2.5 mm <sup>2</sup>	5	1	Male	1	2636180000
HDC MHE 5 FP	16 A	400 V	PUSH IN connection	2.5 mm <sup>2</sup>	5	1	Female	1	2636190000
HDC MHE 6 MP	16 A	500 V	PUSH IN connection	2.5 mm <sup>2</sup>	6	1	Male	1	2748420000
HDC MHE 6 FP	16 A	500 V	PUSH IN connection	2.5 mm <sup>2</sup>	6	1	Female	1	2748430000
HDC MHE 8 MP	16 A	400 V	PUSH IN connection	2.5 mm <sup>2</sup>	8	1	Male	1	2748440000
HDC MHE 8 FP	16 A	400 V	PUSH IN connection	2.5 mm <sup>2</sup>	8	1	Female	1	2748450000
HDC MHD 12 FP	10 A	250 V	PUSH IN connection	1.5 mm <sup>2</sup>	12	1	Male	1	2748470000
HDC MHD 12 MP	10 A	250 V	PUSH IN connection	1.5 mm <sup>2</sup>	12	1	Female	1	2748460000
HDC MDU						0.5	Dummy module	1	1429040000



RockStar® Heavy-duty connectors

Type	Version	Connection technology	Qty	Order No.
<b>HDC connection 4 pole, 400V, 16A, size 1, M20, IP65</b>				
HDC HA 4 FS	Insert, male	Screw connection	1	1498400000
HDC HA 4 MS	Insert, female	Screw connection	1	1498300000
HDC O4A ALU	Bulkhead housing		1	1497600000
HDC O4A AWLU	Angled bulkhead housing		1	1497700000
HDC O4A TOLU 1M20G	Hood, Cable Entry at top		1	1788820000
<b>HDC connection 24 pole, 500V, 16A, size 8, M32, IP65</b>				
HDC HE 24 MQT	Insert, male	SNAP IN connection	1	2667010000
HDC HE 24 FP	Insert, male	PUSH IN connection	1	1873580000
HDC HE 24 FS	Insert, male	Screw connection	1	1211300000
HDC HE 24 FQT	Insert, female	SNAP IN connection	1	2666990000
HDC HE 24 MP	Insert, female	PUSH IN connection	1	1873590000
HDC HE 24 MS	Insert, female	Screw connection	1	1211100000
HDC 24B ADLU	Bulkhead housing		1	1214300000
HDC 64D SDLU 1M32G	Base housing		1	1904440000
HDC 24B TSLU 1M32G	Hood, Cable Entry sideways		1	1787790000





For further products, information, technical specifications or additional services, please visit our website:  
[www.weidmueller.com/as-product-overview](http://www.weidmueller.com/as-product-overview)

## Isolating amplifier and measuring transducer

Isolating amplifiers and measuring transducer are important components in modern industry. They play a decisive role in safe signal transmission and conversion, particularly due to their ability to provide galvanic isolation and EMC filtering. These measures protect systems from voltage peaks and at the same time ensure reliable signal quality. Whether in the process industry or in mechanical engineering - our solutions guarantee efficiency and safety in sensitive applications.

With a wide range of input signals, functions and signal outputs, such as 4–20 mA active/passive or 0–10 V, our measuring transducers offer maximum flexibility and can be easily integrated into existing systems.

### ACT20P – Signal converter and process monitoring for industrial applications

Type	Version	Qty	Order No.
ACT20P-VM-A0-P	Signal converter/insulator, Input: AC/DC voltage, 0...600 V DC, 0...440 V AC, Output: 0-10 V, 0(4)-20 mA, Signal converter/insulator	1	7760054360
ACT20P-Cl-V0-P	Signal converter/insulator, Input: 0(4)-20 mA, Output: 0-10 V, Signal converter/insulator	1	2489740000
ACT20P-Cl-CO-P-P	Signal converter/insulator, Input: 0(4)-20 mA, Output: 0(4)-20 mA, Voltage supply also via CH20M rail bus, Signal converter/insulator, HART®	1	2514620000
ACT20P-Cl1-CO-OLP-P	Signal converter/insulator, Input: 0-20 mA, Output: 4-20 mA, (loop powered), Signal converter/insulator, Output current loop powered	1	7760054353
ACT20P-PRO-RTCI-A0-D0-S	Temperature converter, Limit value monitoring, Input: Temperature, Resistance, Potentiometer, Output: I/U universal, Transistor (Alarm), Temperature converter, Limit value monitoring	1	2448100000
ACT20P-UI-2RCO-DC-S	Limit value monitoring, Input: universal U, I, R, Ω, Output: 2 x relays, Input: temperature, R, U, I, Relay output, 24 V DC power supply	1	7940045760
ACT20P-TCI-2A0-P	Signal duplicator/insulator, Input: Temperature, thermocouple, Output: 2 x I/U, Signal converter/insulator	1	7760054188
ACT20P-VMR-1PH-H-P	Limit value monitoring, Input: 110 / 240 / 400 V AC/DC, Output: 2 x relays, Input: single-phase voltage, Relay output	1	7760054359
ACT20P-UI-2RCO-DC-S	Limit value monitoring, Input: universal U, I, R, Ω, Output: 2 x relays, Input: temperature, R, U, I, Relay output, 24 V DC power supply	1	7940045760
ACT20P-CMT-60-A0-RC-P	Current-measuring transducer, Limit value monitoring, Input: 0...40/50/60 A, Analogue output, Relay output, Current-carrying cable in feed-through hole	1	1510290000
ACT20P-PRO-FI-A0-D0-P	Frequency signal converter, Limit value monitoring, Frequency, PWM, analogue V / mA, Transistor (Alarm)	1	2447950000



### ACT20X – Intrinsically safe signal converter for hazardous areas

Type	Version	Qty	Order No.
ACT20X-HUI-SA0-P	EX signal isolating converter, Ex-output: U, I, R, Ω, Safe-output: 4-20mA/ relay, 1-channel	1	2456200000
ACT20X-2HAI-2SA0-P	EX signal isolating converter, Ex-input: 4 - 20 mA, Safe-output: 4-20mA, 2-channel	1	2456150000
ACT20X-2SAI-2HA0-P	EX signal isolating converter, Safe-input: 4-20mA, Ex output: 4 - 20 mA, 2-channel	1	2456170000
ACT20X-2HTI-2SA0-P	EX signal isolating converter, Ex-input: I, Ω, Safe-output: 4-20mA, 2-channel	1	2456190000
ACT20X-2HDI-2SD0-RN0-P	EX signal isolating converter, Ex-input: NAMUR sensor/switch, Safe-output: relay, NO contact, 2-channel	1	2456080000
ACT20X-2HDI-2SD0-P	EX signal isolating converter, Ex-input: NAMUR sensor/switch, Safe-output: Optocoupler, 2-channel	1	2456100000
ACT20X-2SDI-2HD0-P	EX signal isolating converter, Safe-input: relay, Ex-output: Opto module, 2-channel, Output current: max. 35 mA	1	2456130000



### ACT20C – Network-compatible measuring transducer

Type	Version	Qty	Order No.
ACT20C-8AI-MRTU-DC-S	Input: 8 x 0...10 / 30 V DC, Output: Modbus RTU, Application: Monitoring of H2 fuel and battery cells	1	8000110028



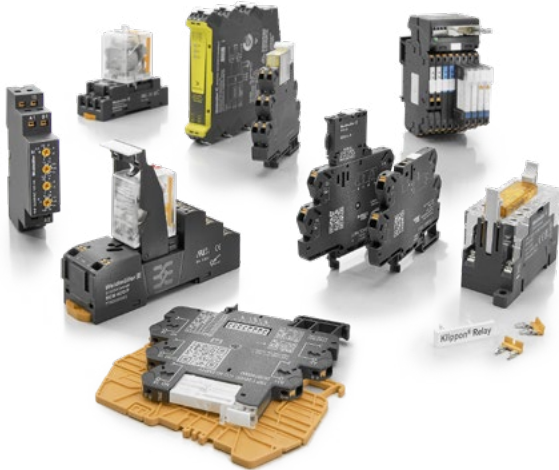

## Relay Modules & Solid-State Relays – Klippon® Relay

Switch to simple– with Klippon® Relay – High-quality relays with unique all-round service

Whether switching, separating, amplifying, or multiplying: relays perform a multitude of different tasks in industrial applications. They have very specific characteristics and are available in almost innumerable varieties on the market. Klippon® Relay from Weidmüller makes your choice easy. Our worldwide unique all-round offer combines maximum relay variety with matching accessories and first-class service. We provide you with high-quality products that have been thought out down to the smallest detail, combined with comprehensive support from product selection to modern data services. Only with Klippon® Relay you can be sure to get the right relay for your specific needs – and save time and money. That's our promise!



For further products, information, technical specifications or additional services, please visit our website: [www.weidmueller.com/klipponrelay](http://www.weidmueller.com/klipponrelay)

### TERMSERIES-compact

Type	Version	Qty	Order No.
TRPL 24VDC 1CO	TERMSERIES-compact, Relay module, Number of contacts: 1, CO contact AgNi, Rated control voltage: 24 V DC ±20 %, Continuous current: 6 A, PUSH IN, Test button available: No	10	2773890000



### TERMSERIES – relay modules

Type	Version	Qty	Order No.
TRP 24VDC 1CO	TERMSERIES, Relay module, Number of contacts: 1, CO contact AgNi, Rated control voltage: 24 V DC ±20 %, Continuous current: 6 A, PUSH IN, Test button available: No	10	2618000000
TRP 24VDC 1CO 16A	TERMSERIES, Relay module, Number of contacts: 1, CO contact AgNi, Rated control voltage: 24 V DC ±20 %, Continuous current: 16 A, PUSH IN, Test button available: No	10	2618100000

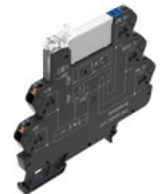

### D-Series – relay modules

Type	Version	Qty	Order No.
SDI 1CO P	D-SERIES DRI, Relay socket, Number of contacts: 1, CO contact, Continuous current: 12 A, PUSH IN	20	7760056364
SCM 2CO P	D-SERIES DRM, Relay socket, Number of contacts: 2, CO contact, Continuous current: 12 A, PUSH IN	10	7760056362
SDI 2CO P	D-SERIES DRI, Relay socket, Number of contacts: 2, CO contact, Continuous current: 8 A, PUSH IN	20	7760056365
SCM 4CO P	D-SERIES DRM, Relay socket, Number of contacts: 4, CO contact, Continuous current: 6 A, PUSH IN	10	7760056363
DRI424024LTD	D-SERIES DRI, Relay, Number of contacts: 2, CO contact AgSnO, Rated control voltage: 24 V DC, Continuous current: 5 A, Flat blade connections (2.5 mm x 0.5 mm), Test button available: Yes	20	7760056340
DRI424024	D-SERIES DRI, Relay, Number of contacts: 2, CO contact AgSnO, Rated control voltage: 24 V DC, Continuous current: 5 A, Flat blade connections (2.5 mm x 0.5 mm), Test button available: No	20	7760056322
DRM570024LT	D-SERIES DRM, Relay, Number of contacts: 4, CO contact, AgNi flash gold-plated, Rated control voltage: 24 V DC, Continuous current: 5 A, Plug-in connection	20	7760056097
DRM570220	D-SERIES DRM, Relay, Number of contacts: 4, CO contact, AgNi flash gold-plated, Rated control voltage: 220 V DC, Continuous current: 5 A, Plug-in connection	20	7760056082
DRH276024LT	D-SERIES DRW / DRH, Relay, Number of contacts: 2, NO contact with blow-out magnet AgSnO, Rated control voltage: 24 V DC, Continuous current: 16 A, Flat blade connections (4.8 mm x 0.5 mm), Test button available: Yes		1220150000
PWR173024L	D-SERIES PWR, Relay module, Number of contacts: 1, NO contact AgSnO, Rated control voltage: 24 V DC, Continuous current: 30 A, Screw connection, Test button available: No		1219480000



**SIL safety relay**

Type	Version	Qty	Order No.
SCS 24VDC P2SIL3ES	SAFESERIES, Safety relay, 24 V DC $\pm 15\%$ , 24 VDC +15% / -10% during auto-start, 35 mA, 5, SIL 3, DIN EN 61508, EN ISO 13849-1 (PLe)	1	1319280000
SCS 24VDC P2SIL3DSES	SAFESERIES, Safety relay, 24 V DC -15 / +20%, 35 mA, Max. switching current, internal fuse: 5 A (refer to derating curve), SIL 3, DIN EN 61508	1	1319270000
SCS 24VDC P1SIL3DS M	SAFESERIES, Safety relay, 24 V DC $\pm 20\%$ , 35 mA, Max. switching current, internal fuse: 5 A (refer to derating curve), SIL 3, EN 61508:2010	1	1303760000
SCS 24VDC P1SIL3ES LL	Safety relay, 24 V DC $\pm 20\%$ , Max. switching current, internal fuse, Safety category: SIL 3 EN 61508:2010	1	2633940000
SCS 24VDC P1SIL3ES LL-T	Safety relay, 24 V DC $\pm 20\%$ , Max. switching current, internal fuse, Safety category: SIL 3 EN 61508:2010	1	2634010000

**SAFESERIES Contact Extension with forcibly guided contacts**

Type	Version	Qty	Order No.
FSKIT 24VDC 2NO2NC FG LD AGSNO AU	SAFESERIES, Relay module with positively driven contacts 2 NC and 2 NO contacts forcibly guided (EN 61810-3 type A) AgSnO gold-plated, Rated control voltage: 24 V DC $\pm 10\%$ , Continuous current: 6 A, Screw connection, Test button available: No	1	2759080000
FSKIT 24VDC 3NO1NC FG LD AGSNO AU	SAFESERIES, Relay module with positively driven contacts 1 NC and 3 NO contacts forcibly guided (EN 61810-3 type A) AgSnO gold-plated, Rated control voltage: 24 V DC $\pm 10\%$ , Continuous current: 6 A, Screw connection, Test button available: No	1	2759070000
FSKIT 24VDC 3NO3NC FG LD AGSNO AU	SAFESERIES, Relay module with positively driven contacts 3 NC and 3 NO contacts forcibly guided (EN 61810-3 type A) AgSnO gold-plated, Rated control voltage: 24 V DC $\pm 10\%$ , Continuous current: 6 A, Screw connection, Test button available: No	1	2759100000
FSKIT 24VDC 4NO2NC FG LD AGSNO AU	SAFESERIES, Relay module with positively driven contacts 2 NC and 4 NO contacts forcibly guided (EN 61810-3 type A) AgSnO gold-plated, Rated control voltage: 24 V DC $\pm 10\%$ , Continuous current: 6 A, Screw connection, Test button available: No	1	2759090000
FSKIT 24VDC 5NO1NC FG LD AGSNO AU	SAFESERIES, Relay module with positively driven contacts 1 NC and 5 NO contacts forcibly guided (EN 61810-3 type A) AgSnO gold-plated, Rated control voltage: 24 V DC $\pm 10\%$ , Continuous current: 6 A, Screw connection, Test button available: No	1	2860020000





## Power Supplies

The switch-mode power supplies feature a high efficiency, compact dimensions and minimal heat generation. They are an excellent and reliable solution for providing power in all automation applications – safely providing 24 V DC voltage. The different product series are optimised for the automation industry: they feature Ex approvals for the processing industry, a flat shape perfect for distribution tasks within buildings and provide decentralised control voltages.

All-purpose usage: with a wide range of AC/DC inputs, single-, double- or three-phase versions and a wide temperature range. Additional performance increases are possible using simple parallel connection. Weidmüller switch-mode power supplies are reliable usable for all applications because of their high efficiency and their resistance to both short circuits and overloads.



For further products, information, technical specifications or additional services, please visit our website: [www.weidmuller.com/powermanagement](http://www.weidmuller.com/powermanagement)

D



### Connect Power PROtop

Type	Version	Qty	Order No.
<b>Connect Power PROtop single-phase</b>			
PRO TOP1 120W 24V 5A	Power supply, switch-mode power supply unit, 24 V	1	2466870000
PRO TOP1 240W 24V 10A	Power supply, switch-mode power supply unit, 24 V	1	2466880000
PRO TOP1 480W 24V 20A	Power supply, switch-mode power supply unit, 24 V	1	2466890000
PRO TOP1 960W 24V 40A	Power supply, switch-mode power supply unit, 24 V	1	2466900000
PRO TOP1 120W 24V 5A EX	Power supply, switch-mode power supply unit, 24 V	1	2466980000
PRO TOP1 240W 24V 10A EX	Power supply, switch-mode power supply unit, 24 V	1	2466990000
PRO TOP1 480W 24V 20A EX	Power supply, switch-mode power supply unit, 24 V	1	2467000000
PRO TOP1 960W 24V 40A EX	Power supply, switch-mode power supply unit, 24 V	1	2467010000
<b>Connect Power PROtop for highest demands, 3-phase</b>			
PRO TOP3 120W 24V 5A CO	Power supply, switch-mode power supply unit, 24 V	1	2467070000
PRO TOP3 240W 24V 10A CO	Power supply, switch-mode power supply unit, 24 V	1	2467090000
PRO TOP3 480W 24V 20A CO	Power supply, switch-mode power supply unit, 24 V	1	2467110000
PRO TOP3 960W 24V 40A CO	Power supply, switch-mode power supply unit, 24 V	1	2467130000



### Communication modules

Type	Version	Qty	Order No.
PRO COM DISPLAY 7S	Communication module	1	2466960000
PRO COM IO-LINK	Communication module	1	2587360000
PRO COM CAN OPEN	Communication module	1	2467320000



### DC/DC converter

Type	Version	Qty	Order No.
PRO TOPDC 24V/24V 5A	DC/DC converter	1	2627650000
PRO TOPDC 24V/24V 10A	DC/DC converter	1	2627640000
PRO TOPDC 24V/24V 20A	DC/DC converter	1	2627630000



**maxGUARD – Electronic load monitoring**

Type	Version	Qty	Order No.
AMG CM EX	Control module, 24 V DC	1	2083360000
AMG ELM-18 EX	Electronic load monitoring, 18 A, 24 V DC	1	2838520000
AMG DIS EX	Potential distributor	10	2495100000
AMG AM CO	Alarm module, 24 V DC	1	2082770000
AMG CM	Control module, 24 V DC	1	2081900000
AMG ELM-18	Electronic load monitoring, 18 A, 24 V DC	10	2859800000
AMG DIS	Potential distributor	10	2123050000
AMG ELM-18	Electronic load monitoring, 18 A, 24 V DC	10	2859800000
AMG MD	Potential distributor	10	2122930000
AMG PD	Potential distributor	10	2122920000

**topGUARD – Electronic load monitoring**

Type	Version	Qty	Order No.
TGD FIM-C	Supply module	1	2625000000

**Connect Power PROmax**

Type	Version	Qty	Order No.
<b>Connect Power PROmax single-phase</b>			
PRO MAX 70W 5V 14A	Power supply, switch-mode power supply unit, 5 V	1	1478210000
PRO MAX 72W 24V 3A	Power supply, switch-mode power supply unit, 24 V	1	1478100000
PRO MAX 240W 24V 10A	Power supply, switch-mode power supply unit, 24 V	1	1478130000
PRO MAX 960W 48V 20A	Power supply, switch-mode power supply unit, 48 V	1	1478270000
<b>Connect Power PROmax 3-phase</b>			
PRO MAX3 120W 24V 5A	Power supply, switch-mode power supply unit, 24 V	1	1478170000
PRO MAX3 240W 24V 10A	Power supply, switch-mode power supply unit, 24 V	1	1478180000
PRO MAX3 480W 24V 20A	Power supply, switch-mode power supply unit, 24 V	1	1478190000
PRO MAX3 960W 24V 40A	Power supply, switch-mode power supply unit, 24 V	1	1478200000

**UPS control unit**

Type	Version	Qty	Order No.
CP DC UPS 24V 20A/10A	UPS control unit	1	1370050010

**Battery module**

Type	Version	Qty	Order No.
DURA ECO LA-BAT 24V 7AH	Battery	1	2789910000
DURA ECO LA-BAT 24V 12AH	Battery	1	2789920000
DURA ECO LA-BAT 24V 17AH	Battery	1	2789930000





## Lightning and Surge Protection

Due to the increasing digitalisation and inter-communication of various electronic devices, they are now much more susceptible to transient and high-energy voltage peaks. With Weidmüller lightning and surge protection for energy, data and signals, you can protect your system and prevent downtimes.



For further products, information, technical specifications or additional services, please visit our website: [www.weidmueller.com/surge-protection](http://www.weidmueller.com/surge-protection)



### Surge protection type I

Type	Version	Qty	Order No.
VPU AC I 3+1 R 440/25 LCF	Surge voltage arrester, Low voltage, Surge protection, with remote contact, TN-C-S, TN-S, TT, IT with N, IT without N	1	2619260000
VPU AC I 3 R 440/25 LCF	Surge voltage arrester, Low voltage, Surge protection, with remote contact, TN-C	1	2619170000
VPU AC I F 1 R 275/25	Surge voltage arrester, Low voltage, Surge protection, TT nur für L-N, TN-C, TN-S	1	2859340000
VPU AC I 3+1 R 275/25 LCF S 2PE	Surge voltage arrester, Low voltage, Surge protection, Leakage-current-free, with remote contact, TN-C-S, TN-S, TT, IT with N, IT without N	1	2726770000
VPU AC I 3 R 275/25 LCF S	Surge voltage arrester, Low voltage, Surge protection, Leakage-current-free, with remote contact, TN-C	1	2726750000
VPU AC I 1+1 R 300/12.5 LH	Surge voltage arrester, Low voltage, Surge protection, with remote contact, Single-phase, TN-C, TN-C-S, TN-S, TT, TN, IT with N, IT without N	1	2983530000
VPU AC I 3+1 R 300/12.5 LH	Surge voltage arrester, Low voltage, Surge protection, with remote contact, TN-C-S, TN-S, TT, IT with N, IT without N	1	2983590000
VPU AC I 3 R 300/12.5 LH	Surge voltage arrester, Low voltage, Surge protection, with remote contact, TN-C	1	2983560000



### Surge protection type II

Type	Version	Qty	Order No.
VPU AC II 2 R 75/50	Surge voltage arrester, Low voltage, Surge protection, with remote contact, Single-phase	1	2591630000
VPU AC II 2 300/50	Surge voltage arrester, Low voltage, Surge protection, Single-phase, TN-S	1	2591040000
VPU AC II 2 R 480/50	Surge voltage arrester, Low voltage, Surge protection, with remote contact, Single-phase	1	2591240000
VPU AC II 4 480/50	Surge voltage arrester, Low voltage, Surge protection, TN-C-S, TN-S	1	2591270000
VPU AC II 1+1 R 300/50	Surge voltage arrester, Low voltage, Surge protection, with remote contact, Single-phase, TN, TN-S, TT, IT with N, IT without N	1	2591070000
VPU AC II 3+1 R 300/50	Surge voltage arrester, Low voltage, Surge protection, with remote contact, TN-C-S, TN-S, TT, IT with N, IT without N	1	2591090000



### Surge protection type III

Type	Version	Qty	Order No.
VPU III R 24V/4KV AC/DC	Surge voltage arrester, Low voltage, with remote contact, Single-phase	1	1351580000
VPU III R 230V/6KV AC	Surge voltage arrester, Low voltage, with remote contact, Single-phase	1	1351650000



## Surge protection for data interfaces

Type	Version	Qty	Order No.
VSPC RS485 2CH R	Surge protection for instrumentation and control, with warning function / function indicator, $U_p$ (L/N-PE) 250 V	1	8951670000
VSPC 2CL HF 24VDC R	Surge protection for instrumentation and control, with warning function / function indicator, $U_p$ (L/N-PE) < 800 V	1	8951700000
VSPC BASE 2CL FG R	Surge protection, Flange-mounted housing, Flange-mounted housing	1	8951720000
VSPC CONTROL UNIT 24VDC	Surge protection for instrumentation and control, with warning function / function indicator	1	8972270000
VSPC 4SL 24VDC EX	Surge protection for instrumentation and control, without warning function / function indicator, $U_p$ (L/N-PE) 250 V	1	1161190000
VSPC BASE 4SL FG EX	Surge protection, Flange-mounted housing, Flange-mounted housing	1	8951840000
VSPC 2CL 24VDC EX	Surge protection for instrumentation and control, without warning function/function indicator, $U_p$ (L/N-PE) < 800 V	1	8953720000
VSPC BASE 2CL FG EX	Surge protection, Flange-mounted housing, Flange-mounted housing	1	8951820000
VSSC6 CL 24VAC/DC 0.5A	Surge protection for instrumentation and control, $U_p$ (L/N-PE) 900 V	10	1064170000
VSSC6 TRSL24VAC/DC0.5A	Surge protection for instrumentation and control, $U_p$ (L/N-PE) 150 V	10	1354790000
VSSC6 RS485	Surge protection for instrumentation and control, $U_p$ (L/N-PE) $\leq$ 100 V	10	1064980000
VSSC6 TR SL FG 24VAC/DC EX	Surge protection for instrumentation and control, $U_p$ (L/N-PE) $\leq$ 1870 V	1	1421440000
VSSC4 CL FG 24VAC/DC EX	Surge protection for instrumentation and control, $U_p$ (L/N-PE) $\leq$ 2000 V	1	1063810000
VSSC6 RS485 PA EX	Surge protection for instrumentation and control, $U_p$ (L/N-PE) $\leq$ 2 kV	1	1065020000



## Surge protection for four wire pairs with RJ45 socket

Type	Version	Qty	Order No.
VDATA CAT6	Terminal rail fixing, Surge protection, Cat.6, PoE, 802.3 bt at Type 1, 802.3 bt at Type 2, 8 3, 802.3 bt at Type 4	1	1348590000





### Enclosure systems and components

We designed the Klippon® Protect enclosure ranges to satisfy the extraordinary protection requirements for field applications. They provide outstanding high-performance features that satisfy the toughest demands within every industry and every application.

Our Klippon® Protect application range provides solutions for monitoring and safety, measurement and control technology, and power distribution. These application solutions are based on high quality and comprehensive approvals for explosive risk zones.

Irrespective of which application users are planning, Weidmüller offers numerous precisely fitting enclosure solutions and individual services: turnkey enclosures with customer-specific configurations such as terminal rails, drilled holes, cable glands, cutouts, special coatings and much more besides.

D



For further products, information, technical specifications or additional services, please visit our website: [www.weidmueller.com/klippon-protect](http://www.weidmueller.com/klippon-protect)



#### Klippon® TB – steel enclosures

Description	Height x width x depth in mm	0 Gland Plates	1 Gland Plate (below)	2 Gland Plates (above + below)	3 Gland plates (below + sides)	4 Gland plates (all sides)
KTb MH 403015 S4E_*	400 x 300 x 150	1194900000	1194910000	1194920000	1194930000	1194940000
KTb MH 403020 S4E_*	400 x 300 x 200	1194950000	1194960000	1194970000	1194980000	1194990000
KTb MH 453815 S4E_*	458 x 382 x 150	1195000000	1195010000	1195020000	1195030000	1195040000
KTb MH 453820 S4E_*	458 x 382 x 200	1195050000	1195060000	1195070000	1195080000	1195090000
KTb QL 403015 S4E_*	400 x 300 x 150	1200220000	1200230000	1200240000	1200250000	1200260000
KTb QL 403020 S4E_*	400 x 300 x 200	1200270000	1200280000	1200290000	1200310000	1200320000
KTb QL 453815 S4E_*	458 x 382 x 150	1200330000	1200340000	1200350000	1200360000	1200370000
KTb QL 453820 S4E_*	458 x 382 x 200	1200380000	1200390000	1200410000	1200420000	1200430000

**Note** \* Placeholder for the number of gland plates (0, 1, 2, 3, 4). The Klippon® TB enclosures with 2 and 4 gland plates are subject to minimum order quantities.



The enclosures are available in 32 standard sizes and three depths. They are made of stainless steel (1.4404 / 316L) and guarantee excellent protection even in the harshest environments thanks to the electropolished surface. In addition customised enclosures with individual dimensions can also be manufactured.





For further products, information, technical specifications or additional services, please visit our website:

[www.weidmueller.com/cabite](http://www.weidmueller.com/cabite)

## Cable Entry Systems and Components

Weidmüller offers you a variety of add-on components for a multitude of applications in addition to its wide range of enclosures. This includes standard brass, plastic, and stainless steel cable glands for industrial and hazardous area applications. In addition to cable glands, there are sealing plugs, pressure compensation elements, and adapters. Relevant accessories, such as lock nuts, sealing and earthing rings are also available.

Furthermore, we support you with our cable entry system, Cabtite. Cabtite offers maximum flexibility and time-savings in the cable management of control cabinets, enclosures, and machines - high packing density in a very small space for pre-assembled and non-preassembled cables.



### Cable entry system – Cabtite

Type	Version	Qty	Order No.
CABTITE FRFT 4-1 SET	Frame, Cabtite (cable entry system), Polyamide, glass fibre-reinforced, Deep black, Height: 64 mm, Width: 81 mm, Depth: 24.2 mm, -40 °C...120 °C, IP66	1	2891470000
CABTITE FRFT 10/6 SET	Frame, Cabtite (cable entry system), Polyamide, glass fibre-reinforced, Deep black, Height: 64 mm, Width: 106 mm, Depth: 24.2 mm, -40 °C...120 °C, IP66	1	2891500000
CABTITE FRFT 16/8 SET	Frame, Cabtite (cable entry system), Polyamide, glass fibre-reinforced, Deep black, Height: 64 mm, Width: 126 mm, Depth: 24.2 mm, -40 °C...120 °C, IP66	1	2891530000
CABTITE FRFT 24/10 SET	Frame, Cabtite (cable entry system), Polyamide, glass fibre-reinforced, Deep black, Height: 64 mm, Width: 153 mm, Depth: 24.2 mm, -40 °C...120 °C, IP66	1	2891560000
CABTITE BSE SML GY	Sealing element, Cabtite (cable entry system), TPE, Light Grey, Height: 20.3 mm, Width: 20.3 mm, Depth: 17.7 mm, -40 °C...90 °C, IP66	10	2583350000
CABTITE BSE LRG GY	Sealing element, Cabtite (cable entry system), TPE, Light Grey, Height: 42.8 mm, Width: 42.8 mm, Depth: 17.7 mm, -40 °C...90 °C, IP66	10	2584520000
CABTITE SE 5-6 SML GY	Sealing element, Cabtite (cable entry system), TPE, Light Grey, Height: 20.3 mm, Width: 20.3 mm, Depth: 17.7 mm, -40 °C...90 °C, IP66	10	2583450000
CABTITE SE 6-7 SML GY	Sealing element, Cabtite (cable entry system), TPE, Light Grey, Height: 20.3 mm, Width: 20.3 mm, Depth: 17.7 mm, -40 °C...90 °C, IP66	10	2583460000
CABTITE SE 10-11 SML GY	Sealing element, Cabtite (cable entry system), TPE, Light Grey, Height: 20.3 mm, Width: 20.3 mm, Depth: 17.7 mm, -40 °C...90 °C, IP66	10	2584610000
CABTITE SE 34-35 LRG GY	Sealing element, Cabtite (cable entry system), TPE, Light Grey, Height: 42.8 mm, Width: 42.8 mm, Depth: 17.7 mm, -40 °C...90 °C, IP66	10	2595530000
CABTITE SE 2/5-6 SML GY	Sealing element, Cabtite (cable entry system), TPE, Light Grey, Height: 20.3 mm, Width: 20.3 mm, Depth: 17.7 mm, -40 °C...90 °C, IP66	10	2584890000
<b>Note</b>	You can find further variants in our online catalogue at <a href="http://eshop.weidmueller.com">eshop.weidmueller.com</a>		





### Industrial Ethernet

Weidmüller Industrial Ethernet components are the perfect link for data communication between Ethernet enabled devices in industrial automation. By supporting various topologies and protocols, they can be used in many industrial applications. As a complete provider of industrial network infrastructure for machine and equipment manufacture, we offer a wide range of switch products to suit the individual needs of our customers. In particular, Gigabit switches (unmanaged and managed) and media converters, Power-over-Ethernet switches, WLAN devices and serial/Ethernet converters to meet the highest requirements and provide a reliable and flexible Ethernet communication. An extensive passive product portfolio consisting of RJ 45 and fibre optic connectors and cables make Weidmüller your partner for industrial Ethernet solutions.



For further products, information, technical specifications or additional services, please visit our website: [www.weidmueller.com/ie](http://www.weidmueller.com/ie)

#### Industrial Ethernet – Active components

Type	Version	Qty	Order No.
IE-SW-ELB-05-5TX	Network switch, unmanaged, Fast Ethernet, Number of ports: 5x RJ45, IP40, -10 °C...60 °C	1	2828540000
IE-SW-BLB-10-8GT-2GESFP	Network switch, unmanaged, Gigabit Ethernet, Number of ports: 8x RJ45, 2x 100/1000BaseSFP Slot, IP30, -40 °C...75 °C	1	2908190000
IE-SW-EL08-8PDE	Network switch, unmanaged PoE, Fast Ethernet, Number of ports: 8x RJ45 10/100 BaseT(X) PoE+, IP30, -40 °C...75 °C	1	2682380000
IE-SW-AL08M-8GT	Network switch, managed, Gigabit Ethernet, Number of ports: 8x RJ45, IP30, -40 °C...75 °C	1	2682350000
IE-SW-AL12M-8GT-4GESFP	Netzwerk Switch, managed, Gigabit Ethernet, Anzahl Ports: 8x RJ45, 4x 100/1000BaseSFP Slot, IP30, -40 °C...75 °C	1	2682340000
IE-SW-SL26M-24TX-2GC-LV	Layer 2 Network Switch, 19" rack mount, managed, Fast/Gigabit Ethernet, IEC 61850-3 / IEEE 1613, low voltage, Number of ports: 24x RJ45 10/100BASET(X), 2x combo-ports (10/100/1000BaseT(X) or 100/1000BaseSFP), IP30, -40 °C...85 °C	1	2779000000
IE-SFP-1GE-SM-10	SFP Transceiver, 1000 Mbps, Singlemode, LC-Duplex, 10 km, -40 °C...85 °C	1	2682500000
IE-CS-MBGW-2TX-1COM	Serial/Ethernet converter and Modbus TCP/RTU gateway, Number of ports: 2x RJ45 10/100BASE-T(X), 1x DB9 male for RS-232/422/485, IP30, -40 °C...70 °C	1	2682600000
IE-MC-VLT-1TX-1SCS	Media converter, Fast Ethernet, Number of ports: 1x RJ45, 1 * SC Single-mode, IP30, -40 °C...75 °C	1	1286900000
IE-WLT-BL-AP-CL-EU	Wireless Access Point/Client, IEEE 802.11 a/b/g/n, EU-Model, IP30, -40 °C...75 °C	1	2536650000
IE-SR-4GT-LTE-4G-USEMEA	Security/NAT/VPN/U-link Router, with integrated multi-band modem (4G/3G), US/EMEA-model, Gigabit Ethernet, 4x RJ45 10/100/1000BaseT(X), IP20, -25 °C...70 °C	1	2873930000
U-LINK-50-DEVICES-1Y	License code for u-link Remote Access Service., Adds 50 additional configurable u-link clients on Weidmüller hardware to the basic license and extends the period of the basic license accordingly	1	2870090000



#### Industrial Ethernet – Passive components

Type	Version	Qty	Order No.
IE-FC-SET-IPDED003-KY-M	Service Interface for Cabinets	1	2460640000
IE-FCM-RJ45-C	Service Interface for Cabinets	1	1018790000
IE-PS-RJ45-FH-BK	RJ45 IP20 Connector	1	1963600000
IE-TO-RJ45-C	Outlet for Cabinet	1	8946920000
IE-C6FP8LD0002M40M40-D	Patchcord	1	1165940002





## Controls and Gateways

For modern IoT applications, automation technology needs to be increasingly more powerful and adaptable. u-mation offers a coordinated hardware portfolio designed for the future-proof preparation of your machines and systems. u-control 2000 is one of the most compact and state-of-the-art control systems on the market and is the centrepiece of our hardware portfolio. With u-control M3000, automation solutions can be perfectly integrated into the IoT. The powerful controller also works as an edge device for providing local information in the network and can be expanded by connecting function modules – ideal for automation and IIoT applications. The controllers modular design is based on the remote I/O system u-remote, and allows for needs-based expansion to include other components from the u-mation family.



For further products, information, technical specifications or additional services, please visit our website:  
[www.weidmueller.com/controls](http://www.weidmueller.com/controls)

### u-control web

Type	Version	Qty	Order No.
UC20-WL2000-AC	Controller, IP20, AutomationController, Web-based, u-control 2000 web, integrated engineering tool: u-create web for PLC - (real-time system) & IIoT applications, CoDeSys	1	1334950000
UC20-WL2000-AC-CAN	Controller, IP20, AutomationController, Web-based, u-control 2000 web, integrated engineering tool: u-create web for PLC - (real-time system) & IIoT applications, CoDeSys	1	2928020000



### u-control M3000/M4000

Type	Version	Qty	Order No.
UC20-M3000	Controller, IP20, AutomationController, CoDeSys	1	2839150000
UC20-M4000	Controller, IP20, AutomationController, CoDeSys	1	2839160000



### IoT-Gateways

Type	Version	Qty	Order No.
IOT-GW30	IoT Gateway, Fast Ethernet, IP20, -20 °C...60 °C	1	2682620000
IOT-GW30-4G-EU	IoT Gateway, Fast Ethernet, IP20, -20 °C...60 °C	1	2682630000



### Industrial PCs

Type	Version	Qty	Order No.
UV20-B-IPC-2001.01	Industrial PC, IP20	1	2676370000
UV20-B-IPC-3000.01	Industrial PC, IP20	1	2676390000





## I/O Systems

For future-oriented Industry 4.0 inside and outside the electrical cabinet, Weidmüller's flexible remote I/O systems offer automation at it's best.

u-remote from Weidmüller forms a reliable and efficient interface between the control and field levels. The I/O system impresses with its simple handling, high degree of flexibility and modularity as well as outstanding performance. The two I/O systems UR20 and UR67 cover all common signals and fieldbus/network protocols in automation technology.

D



For further products, information, technical specifications or additional services, please visit our website:

[www.weidmueller.com/u-remote](http://www.weidmueller.com/u-remote)



### Fieldbus coupler

Type	Version	Qty	Order No.
UR20-FBC-PN-IRT-V2	Remote I/O fieldbus coupler, IP20, Ethernet, PROFINET IRT	1	2566380000
UR20-FBC-PB-DP-V2	Remote I/O fieldbus coupler, IP20, PROFIBUS DP-V1	1	2614380000
UR20-FBC-EC	Remote I/O fieldbus coupler, IP20, Ethernet, EtherCAT	1	1334910000
UR20-FBC-MOD-TCP-V2	Remote I/O fieldbus coupler, IP20, Ethernet, Modbus/TCP	1	2476450000
UR20-FBC-EIP	Remote I/O fieldbus coupler, IP20, Ethernet, EtherNet/IP	1	1334920000
UR20-FBC-CAN	Remote I/O fieldbus coupler, IP20, CANopen	1	1334890000
UR20-FBC-DN	Remote I/O fieldbus coupler, IP20, DeviceNet	1	1334900000
UR20-FBC-CC	Remote I/O fieldbus coupler, IP20, CC-Link	1	2625010000
UR20-FBC-CC-TSN	Remote I/O fieldbus coupler, IP20, CC-Link IE TSN	1	2680260000
UR20-FBC-PL	Remote I/O fieldbus coupler, IP20, Ethernet, POWERLINK	1	1334940000
UR20-FBC-IEC61162-450	Remote I/O fieldbus coupler, IP20, Ethernet, IEC 61162-450	1	2661310000



CC-Link V2

EtherCAT

ETHERNET POWERLINK

CANopen

ModbusTCP

CC-Link IETSN

EtherNet/IP

POWERLINK

CC-Link IETSN

DeviceNet

### Modules

Type	Version	Qty	Order No.
<b>Digital input modules</b>			
UR20-4DI-P	Remote I/O module, IP20, Digital signals, Input, 4-channel	1	1315170000
UR20-8DI-P-2W	Remote I/O module, IP20, Digital signals, Input, 8-channel, 2-conductor connection	1	1315180000
UR20-16DI-P	Remote I/O module, IP20, Digital signals, Input, 16-channel	1	1315200000
UR20-4DO-P	Remote I/O module, IP20, Digital signals, Output, 4-channel	1	1315220000
UR20-4DO-P-2A	Remote I/O module, IP20, Digital signals, Output, 4-channel, 2 A per channel	1	1315230000
UR20-8DO-P	Remote I/O module, IP20, Digital signals, Output, 8-channel	1	1315240000
UR20-16DO-P	Remote I/O module, IP20, Digital signals, Output, 16-channel	1	1315250000
UR20-8DI-P-3W	Remote I/O module, IP20, Digital signals, Input, 8-channel	1	1394400000
<b>Analogue input modules</b>			
UR20-4AI-UI-16	Remote I/O module, IP20, 4-channel, Analog signals, Input, Current/Voltage, 16 Bit	1	1315620000
UR20-4AI-HART-16-DIAG	Remote I/O module, IP20, Analog signals, Input, 4-channel, HART®	1	2617520000
UR20-15AI-U-16	Remote I/O module, IP20, 15-channel, Analog signals, Input, Voltage, 16 Bit	1	3039320000
<b>Analogue output modules</b>			
UR20-4AO-UI-16	Remote I/O module, IP20, Analog signals, Output, 4-channel, Current/Voltage	1	1315680000
UR20-2AO-UI-16	Remote I/O module, IP20, Analog signals, Output, 2-channel, Current/Voltage	1	2705630000
<b>Temperature modules and potentiometer input module</b>			
UR20-4AI-RTD-DIAG	Remote I/O module, IP20, Analog signals, Temperature, RTD	1	1315700000
UR20-4AI-TC-DIAG	Remote I/O module, IP20, Analog signals, Temperature, TC	1	1315710000
<b>Power-feed modules</b>			
UR20-PFI	Remote I/O module, IP20, Power supply unit, 24 VDC-Input	1	1334710000
UR20-PFO	Remote I/O module, IP20, Power supply unit, 24 VDC-Output	1	1334740000
<b>Safe I/O modules and safe power-feed modules</b>			
UR20-4DI-4DO-PN-FSPS-V2	Remote I/O module, IP20, Safety, Digital signals, 4-channel	1	2464570000
UR20-8DI-PN-FSPS-V2	Remote I/O module, IP20, Safety, Digital signals, 8-channel	1	2464590000
<b>Digital counter- and communication- modules</b>			
UR20-1COM-232-485-422-V2	Remote I/O module, IP20, 1-channel, RS232/RS485/RS422 communication, PUSH IN connection	1	2826800000





## Measuring and Monitoring Systems

Many companies would like to save energy at source, use energy more efficiently and maximise the availability of energy networks. This not only shows responsibility, but is also recommended for economic reasons.

Weidmüller energy meters can do far more than just measure the consumption of electrical energy. For example, the basic parameters for energy quality can also be determined or the currents of all conductors can be analysed individually or differentially - e.g. with our Energy Meter. This allows you a quick status overview of the electrical energy in your production facility. This applies both in relation to efficient usage, as well as to quality, stability and availability.



For further products, information, technical specifications or additional services, please visit our website:

[www.weidmueller.com/measuring-and-monitoring](http://www.weidmueller.com/measuring-and-monitoring)

### Energy meters – BasicLine

Type	Version	Qty	Order No.
EM220-RTU-4DI2DO-6W	Power measurement/display for 1-; 3-phase mains, use of CT, pulse output, digital input/output, Modbus RTU, Modbus TCP/IP, Gateway	1	7760051006
EM122-RTU-2P	Power measurement/display for 1-; 3-phase mains, 100 A, direct measurement, pulse output, Modbus RTU	1	7760051003



### Energy meters – ValueLine

Type	Version	Qty	Order No.
ENERGY METER 750-230		1	2540910000



### Energy Analyser

Type	Version	Qty	Order No.
ENERGY ANALYSER 750-24		1	2534160000



### Energy / Data Logger

Type	Version	Qty	Order No.
ENERGY LOGGER D550		1	2425520000



### ResMa® – Resource Management for Process and Energy Optimisation

Type	Version	Qty	Order No.
Resma Base Package	Create the necessary transparency with ResMa® Basic as energy management software to make optimal use of your data and uncover potential.		Please contact us
ResMa® Energy Package	The ResMa® Energy Package is a DIN EN ISO 50001 certified energy management system that supports you as energy management software.		Please contact us
ResMa® Production Package	The ResMa® Energy Package is a DIN EN ISO 50001 certified energy management system that supports you as energy management software.		Please contact us
<b>Note</b>	For more information, please visit our website <a href="http://www.weidmueller-gti-software.com">www.weidmueller-gti-software.com</a>		



# The Expansion of Hydrogen Refueling Stations Picks Up Speed with Sonepar

Thanks to the collaboration between Sonepar and Weidmüller, another H2 refueling station is ready for operation

The push for renewable energy is accelerating, bringing new technologies like hydrogen to the forefront. Establishing hydrogen infrastructure involves both expanding existing systems and creating entirely new ones. Installing these systems requires adherence to numerous technical specifications.



D



»Thanks to Weidmüller’s broad portfolio, Sonepar was able to offer the customer a solution from a single source. This increases efficiency for the end user. Weidmüller components can co-operate with third-party systems such as EtherCAT, ProfiNET, ModBUS TCP/IP, EtherNet/IP... At the same time, they work perfectly together, which minimizes the installation effort for the customer.«

Laurent Dussouchet, Head of Global Distribution Account Management





## The challenge

Hydrogen refueling stations have unique requirements compared to conventional petrol stations. In Central Europe's average temperatures, hydrogen is typically refueled in a gaseous state. Tanks must be cooled to minus 253 degrees Celsius for liquid hydrogen refueling, necessitating components adapted to these extreme conditions.

For this reason, a French provider contacted Sonepar France, to whom they presented their requirements: As a hydrogen refueling station is an Ex-area, the provider wants to use EtherCAT to communicate the H2 refueling station. The real-time capability of the field bus is important for safety at the H2 Dispenser. In addition, the products need to work efficiently while maintaining high performance.

## The solution

Sonepar's and Weidmüller's experts worked together on the planning and installation. The two companies have been partners for many years and complement each other perfectly. Sonepar's extensive sales network and its competence in the field of logistics are rounded off by Weidmüller's technical expertise. Together, we were able to create the best solution for the customer's requirements.

The hydrogen tanks are equipped with sensors to detect leaks and potential hazards at an early stage. These collect data and forward it to the control system in real-time. For the

control system to be able to analyze this data, an I/O system must first perform translation work.

Sonepar offered the refueling station provider the u-remote, I/O system from Weidmüller. With eleven protocols, u-remote covers a broad spectrum of requirements. At the same time, the portfolio consists of various modules that are equipped for a wide range of tasks. The integrated web server also makes it easier to set up the I/O system. The u-remote system also has Zone 2 Ex-approval and can be integrated by Weidmüller in Ex-environment solutions.

In addition, the power supplies PROtop and PROeco from Weidmüller as well as the load management modules maxGUARD and EX junction boxes ensure safety at the hydrogen refueling station.

## The result

The provider of hydrogen refueling stations benefits from the streamlined cooperation between Sonepar and Weidmüller. The best-in-class service to which Sonepar is committed is complemented by customized solutions from Weidmüller.

This way, the two companies ensure that their customers can benefit from the latest technical innovations.



Weidmüller I/O system u-remote



Weidmüller power supply portfolio

# Green containers make biogas plants CO<sub>2</sub>-negative

## Bavarian Startup Reverion Brings Reversible Power-to-Gas Technology to Life with Weidmüller Solutions

While many companies strive to neutralise their CO<sub>2</sub> footprint, the Bavarian startup Reverion takes it a step further: their innovative power plants, housed in green freight containers, enable a negative CO<sub>2</sub> balance. Reverion was spun off from the Technical University of Munich and has already received numerous prestigious start-up awards and funding, including awards from the Federal Ministries of Economics and Climate Protection, Education and Research and initiatives such as SPRIN-D and the European Innovation Council.

D

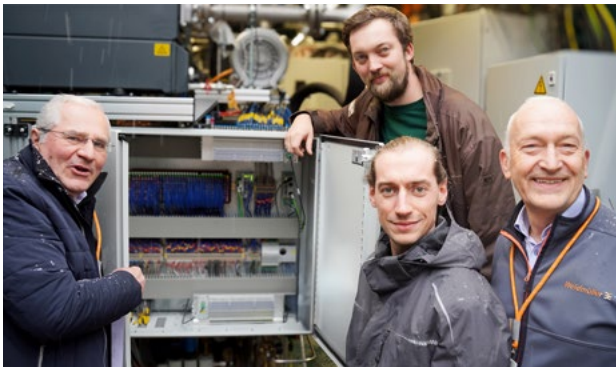

In combination with a biogas plant, Reverions container solutions not only convert power, but can even actively bind CO<sub>2</sub> and make it available for sustainable further use or permanent storage. Weidmüller supplies key components for monitoring.  
Image source: Reverion GmbH, Lisa Männel





## Green containers make biogas plants CO<sub>2</sub>-negative

A key element of Reverion's technology is the efficient conversion of electricity into storage gas – either green hydrogen or synthetic methane – and vice versa, addressing the challenges of the energy transition. This is how the challenges of the energy transition are mastered. In combination with a biogas plant, their container solutions not only convert power, but can even actively bind CO<sub>2</sub> and make it available for sustainable further use or permanent storage – a decisive contribution to combating climate change. Reverion is supported by technology partner Weidmüller, which provides tailored hardware and software solutions to accelerate mass production and industrial implementation.

Reverion's patented technology is based on high-temperature fuel cells with a unique reversible system design. During operation, biogas, hydrogen, or methane is converted into electricity, while in electrolysis mode, the same system can transform electrical energy into hydrogen or methane. This allows excess energy to be stored as gas, which can later be reconverted into electricity when needed. In both modes, the system achieves a groundbreaking electrical efficiency of up to 80%. Given the fluctuations in solar and wind energy availability, a flexible and reliable energy management system is essential. Reverion's technology provides a forward-thinking solution, supporting the transition towards a climate-neutral future.



Reverion is supported in this endeavour by its technology partner Weidmüller. The cooperation is driving forward series production and the industrial implementation of Reverion technology (from left to right: Dirk Bauerkämper, Wolfgang Nagl (Weidmüller), Konrad Bierlein, Sebastian Arend (Reverion)) Image source: Reverion GmbH, Lisa Männel



In Reverion's green containers, electricity is converted into storage gas - and vice versa. Image source: Reverion GmbH, Fabian Vogl

## A Biogas Revolution: Greater Efficiency Through Innovation

Although traditional biogas plants contribute to the generation of renewable power, they release CO<sub>2</sub> when generating electricity using combined heat and power plants. As this CO<sub>2</sub> was originally absorbed off the atmosphere by plants during their growth, it is merely recycled. This means that no additional CO<sub>2</sub> is produced, which means that the process can already be considered offset and therefore climate-neutral.

Reverion aims to revolutionise biogas plants by replacing conventional gas generators with their high-temperature fuel cell power plant. Reverion's system doubles the efficiency of the plants, enabling up to 100 % more power to be obtained from the same quantity of biogas. The CO<sub>2</sub> content is also extracted off the biogas and can be stored as pure, biogenic CO<sub>2</sub>. The stored CO<sub>2</sub> can be used as carbon dioxide in the beverage industry or in breweries, for example.

## Maximum flexibility in operation

A standout feature of Reverion's technology is its flexibility and rapid switching between operational modes. When there is excess electricity from solar or wind power, the Reverion unit can store it by converting it into hydrogen or synthetic methane. "In this case, our unit functions as an electrolyser," explains Konrad Bierlein, Production Engineer for Electrical Engineering at Reverion. The



Weidmüller's innovative products for stack monitoring are crucial for the security and efficient operation of these central system components in conjunction with the other units.

Image source: Reverion GmbH, Lisa Männel

generated hydrogen can be sold to hydrogen refuelling stations, while the synthetic methane can be fed into the gas grid. Conversely, the system can switch modes in less than a minute, using the same fuel cells to generate electricity and feed power into the grid on demand, for example, during periods of low renewable energy generation. This makes Reverion a key technology for making the energy transition practical and scalable.

Inside Reverion's green containers, advanced thermal and chemical processes are controlled by cutting-edge process technology and high-tech automation. Through close collaboration with global electrical and connectivity experts such as Weidmüller, the startup—already managing a high volume of pre-orders—has one less concern to worry about.

### Smart Stack Monitoring by Weidmüller

By integrating Weidmüller components and services, the efficiency of Reverion's plants is further increased. Weidmüller contributes its extensive technology experience in the development of automation and hydrogen monitoring, enabling Reverion to operate its complex process safely and efficiently. Weidmüller's innovative products for stack monitoring are crucial for the security and efficient operation of these central system components in conjunction with the other units.

As an experienced technology partner, Weidmüller supports the operation of Reverion's systems with customised

solutions in the areas of automation, measurement and monitoring technology and all connectivity solutions. „Our systems guarantee precise and secure operation in both modes. One example is the ACT20C module, which monitors voltage in the fuel cell stacks,” explains Dirk Bauerkämper, Head of Market Management New Energies at Weidmüller. These stacks, which are responsible for electrolysis and fuel cell operation, are at the heart of the Reverion technology. Their compact design, high insulation voltage, and multi-channel configuration make Weidmüller's solutions ideal for these plants.

### Another Key to the Energy Transition

As hydrogen continues to be recognised as a future-proof energy carrier, Reverion's technology stands out because it can optimise existing biogas plants while also enabling CO<sub>2</sub>-negative operation. By combining renewable gas production with electricity generation, Reverion's systems not only offer major efficiency gains but also enhance energy supply flexibility. In periods of solar and wind energy fluctuations, the technology ensures reliable reconversion of stored energy into electricity – while also providing additional revenue streams for agricultural businesses. “While others are still developing hydrogen strategies, Reverion is already deploying the technology. This is a real game changer. At Weidmüller, as pioneers in electrical engineering, we are particularly excited to support such groundbreaking projects,” concludes Bauerkämper.



u-remote offers the perfect solution for all common areas of application within machinery construction. Whether as a pure control cabinet system, in mixed IP20 and IP67 applications or placed directly in the field for signal connection. Image source: Reverion GmbH, Lisa Männel

# DC Microgrids

<b>DC Microgrids</b>	Introduction	E.2
	Applications and design for DC Microgrids	E.3
	Industry standard for the power network of the future	E.6
	DC ready product range in the online shop	E.7
	Overview of products and solutions	E.8
	<b>DC ready</b> products and solutions	E.10
	Success Story DC Innovation Hub at the Weidmüller Academy	E.26



# DC Microgrids

## Higher energy efficiency and grid quality thanks to direct current

The use of direct current in microgrids is establishing itself as a transformative technology and a path to climate neutrality. The technology significantly reduces energy consumption in industrial plants or buildings. It prevents peak loads and allows power to be utilised for other consumers directly, safely and in high quality by means of recuperation, e.g. through braking or lowering energy. At the same time, it enables the seamless integration of new energy sources.

E

Another key advantage of DC grids is the significantly improved grid quality and the associated higher security of supply compared to conventional AC grids.



As a founding member of the ODCA (Open DC Alliance) and an active stakeholder in the initial projects DC-INDUSTRIE and DC-INDUSTRIE 2, we are pioneers in the industrial application of DC grids. We already offer a comprehensive portfolio of solutions and components that enable the implementation and commissioning of DC grids.



For further information, technical specifications or additional services, please visit our website: [www.weidmueller.com/dc-microgrids](http://www.weidmueller.com/dc-microgrids)

### Potentials of industrial DC power distribution



#### Energy efficiency

Lower conversion and transport losses, use of recuperation, direct use of renewable energy sources as well as peak power reduction through the use of suitable storage systems.



#### Grid stability

No need for additional investments for grid filtering and compensation, support for existing grids and prevention and reduction of production losses due to grid disturbances.



#### Resource efficiency

Reduction of copper consumption for cables and lower equipment costs and space savings through the elimination of power electronics.



#### Industrial smart DC grid

Infrastructure for intelligent control of energy flows, offering advantages in energy purchasing and support for modular machine concepts.

# DC Microgrids in various applications

## Direct current technology for a sustainable industry

DC Microgrids can demonstrably improve energy efficiency in various applications in industrial plants and buildings. Machines, robots, ventilation, lifting and conveyor belt applications stand to benefit in particular from the utilisation of braking and sinking energy. This can measurably reduce energy consumption by up to 10% and the feed-in power by up to 80%. With integrated storage, peak loads can be reduced by up to 50%.

E

DC ready



Automotive &amp; Robotics



Intralogistics



Machine and factory automation



Building

# DC-Microgrid at a glance

## Modular. Efficient. Networked.

From generation to storage to supply: A DC Microgrid is an independent grid that is connected to the public AC supply grid and contains various DC sectors, i.e. typical more than one machine. The simplified bidirectionality of DC current make functions such as recuperation possible. This improves the energy efficiency and flexibility of the overall system.

### E

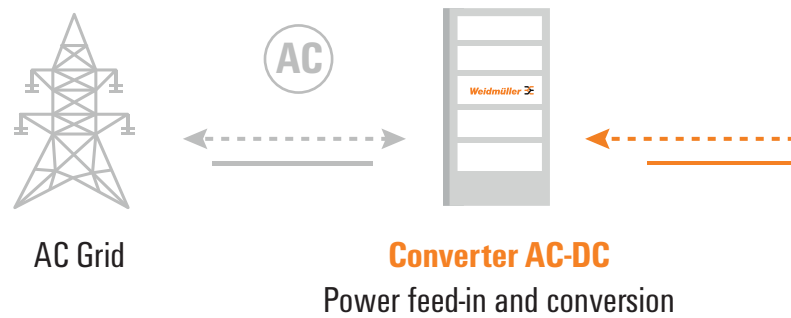

**Convert, protect and distribute energy flows**  
Conversion of both AC to DC and DC to DC voltages, secure and controlled precharging of capacities and distribution in the control cabinet and in the field.

**Energy storage**

Energy from recuperation, for example, can be stored and supplied to other consumers directly, safely and in high quality.



Energy Storage

**Integration of new energy sources**

Conversion-optimised integration of PV or wind energy

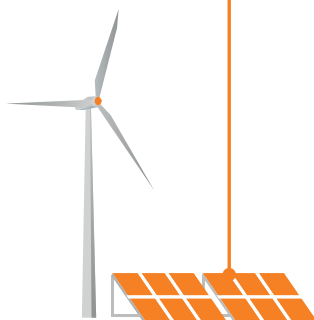

New Energy

**E-mobility**

Integration of efficient charging concepts and dynamic load management



Charging Infrastructure

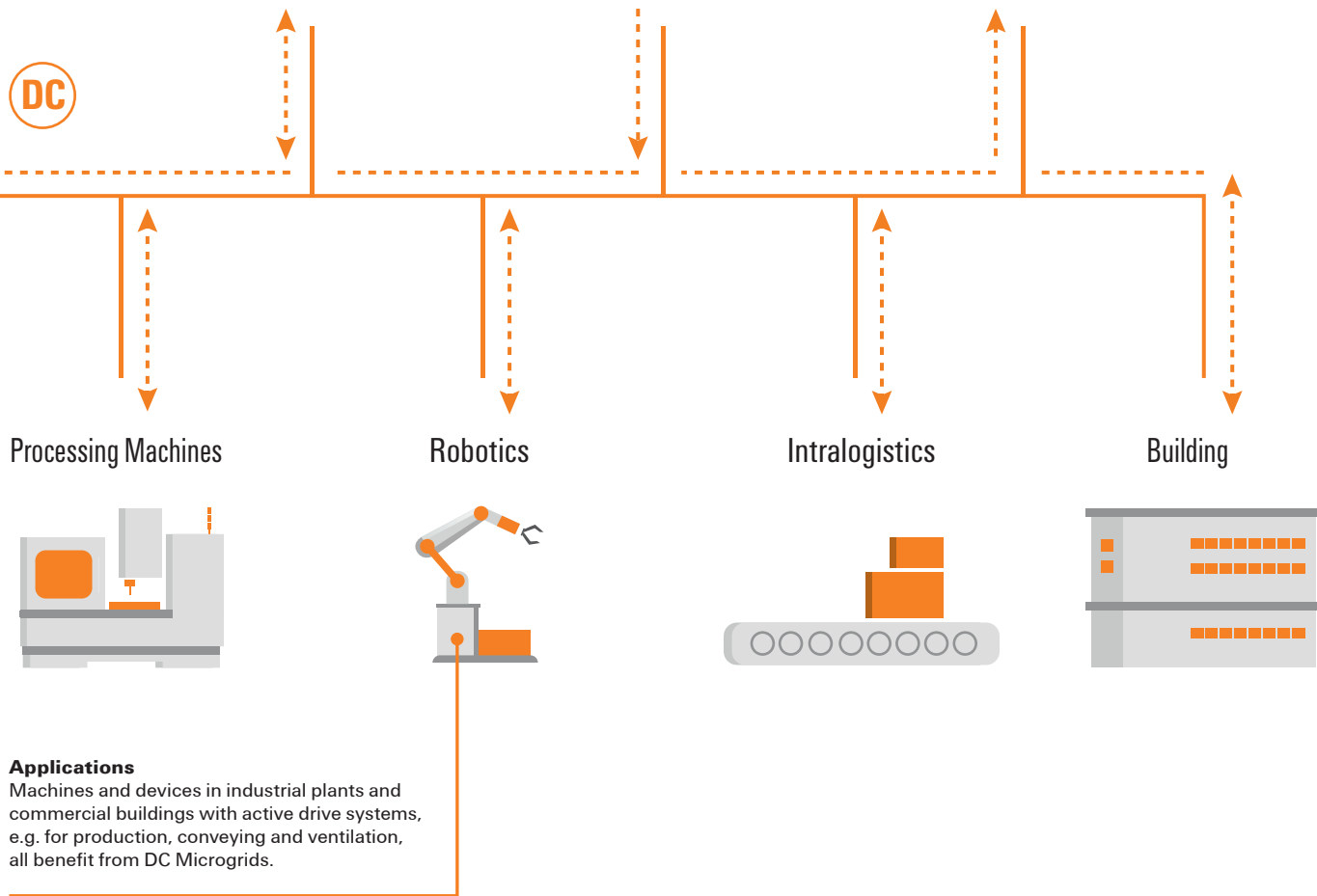

**Applications**

Machines and devices in industrial plants and commercial buildings with active drive systems, e.g. for production, conveying and ventilation, all benefit from DC Microgrids.



# DC ready – Industrial standard for the power network of the future

## Weidmüller solutions for industrial DC applications – in accordance with VDE SPEC 90037



At Weidmüller, DC ready stands for components, systems and solutions prepared for use in industrial DC networks (DC microgrids). They meet the technical requirements for planning, installation and safe operation – from power feed-in to distribution to fuse protection.

VDE SPEC 90037 serves as a central reference document for DC planning. It provides a comprehensive description of DC networks, defines voltage ranges, explains protective mechanisms and addresses specific component requirements.

Particularly in an area where few standards have been established, it is an important point of orientation for planners, installers and end users.

Our DC ready products and solutions meet exactly these requirements – safely and practically, in compliance with relevant standards.

E



Learn more about VDE SPEC 90037  
with a free download (English):

<https://www.vde.com/en/working-areas/standards/spec/vde-spec-publications>

## Visit our online shop, and discover our complete DC ready product range!

You can use our special “DC ready product range” filter to easily display all products suitable for use in DC microgrids. You’ll find everything you need from us. Discover now, and help shape the future!



Our online shop is available at the following link:  
[eshop.weidmueller.com](https://eshop.weidmueller.com)

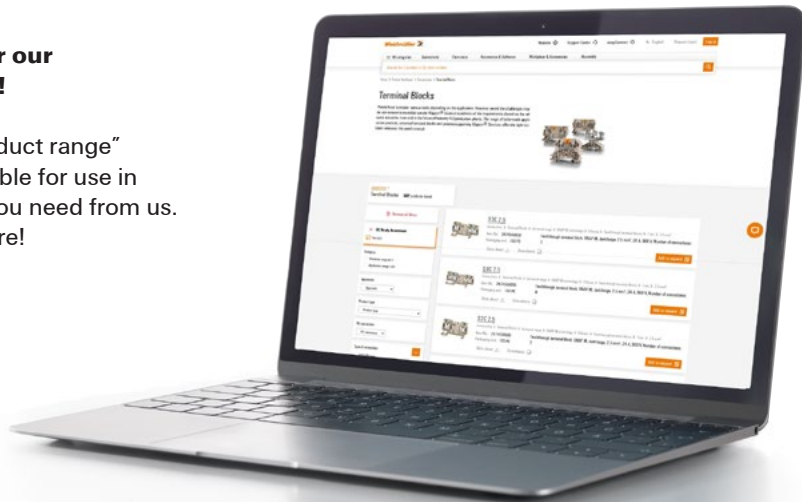

- 1 Select the product area, for instance terminal blocks
- 2 Select the “DC ready product range” filter

The screenshot shows the Weidmüller online shop interface. The main navigation bar includes 'All categories', 'Connectivity', 'Electronics', 'Automation & Software', 'Workplace & Accessories', and 'Assembly'. A search bar is present with the text 'Search for a product or by item number'. The breadcrumb trail reads 'Home > Product Catalogue > Connectivity > Terminal Blocks'. The page title is 'Terminal Blocks'. A paragraph of text explains that panels have to master various tasks depending on the application, and that Klippon Connect combines all requirements for relevant industries now and in the future of Industry 4.0 production plants. Below the text is an image of several terminal blocks. On the left side, there is a filter sidebar with the following options:

- Connectivity > Terminal Blocks 562 products found
- Remove all filters
- DC Ready Assortment
  - Yes (562)
- Category
  - Universal range (417)
  - Application range (148)
- Approvals
  - Approvals
- Product type
  - Product type
- PE connection
  - PE connection
- Type of connection
  - PUSH IN (174)

The main product list shows three items:

- S3C 2.5**: Connectivity > Terminal Blocks > Universal range > SNAP IN technology > S-Series > Feed-through terminal blocks > 1 tier > 2.5 mm<sup>2</sup>. Item No.: 2674540000. Feed-through terminal block, SNAP IN, dark beige, 2.5 mm<sup>2</sup>, 24 A, 800 V, Number of connections: 3. Packaging unit: 100 PC. Add to request.
- S4C 2.5**: Connectivity > Terminal Blocks > Universal range > SNAP IN technology > S-Series > Feed-through terminal blocks > 1 tier > 2.5 mm<sup>2</sup>. Item No.: 2674550000. Feed-through terminal block, SNAP IN, dark beige, 2.5 mm<sup>2</sup>, 24 A, 800 V, Number of connections: 4. Packaging unit: 100 PC. Add to request.
- S2C 2.5**: Connectivity > Terminal Blocks > Universal range > SNAP IN technology > S-Series > Feed-through terminal blocks > 1 tier > 2.5 mm<sup>2</sup>. Item No.: 2674530000. Feed-through terminal block, SNAP IN, dark beige, 2.5 mm<sup>2</sup>, 24 A, 800 V, Number of connections: 2. Packaging unit: 100 PC. Add to request.

# Our products, solutions and services for DC Microgrids

## Fields of application for centralised DC power distribution and processing

We offer a comprehensive portfolio of solutions and components for the implementation and commissioning of DC Microgrids. This includes secure connectivity, solutions for power distribution and monitoring energy flows and decentralised automation tasks. We're **DC ready**. How about you?

### E



#### 1 Connectivity – Klippon® Connect terminal blocks

Terminal blocks with the SNAP IN or PUSH IN connection system fulfil the requirements of AC and DC rated voltages up to 1000 V for wiring to the feed-in and distribution to the functional areas.

#### 2 Relays and solid-state relays

Switching, separating, amplifying, or multiplying: relay modules and solid-state relays perform many different tasks in industrial applications.

#### 3 Power supplies

Our switched-mode power supplies in the three performance classes PROtop, PROMax and PROeco offer a high degree of safety and easily withstand harsh industrial environments. They can be operated on both AC and DC networks.

#### 4 VARITECTOR lightning and surge protection

Lightning and surge protection devices that conform to the standards of DIN VDE 0100-443 and -534 for mandatory surge protection in building infrastructures.

#### 5 Automation and software

Optimise your automation processes – Easy and IoT ready





### 6 Isolating amplifier and measuring transducer

ACT20 signal inverters and current transducers measure and monitor direct and alternating currents in a wide range of industrial zones. They can be used, for instance, to control the power flows for DC networks, which require continuous power calculation based on a DC sector current and voltage measurement.

### 7 Media converters and protocol gateways

Our media converters and protocol gateways ensure smooth communication between all network participants and are also especially convenient and economical.

### 8 OMNIMATE® PCB terminal blocks and plug-in connectors

OMNIMATE® Power: the secure AC and DC connection with PCB terminal blocks, PCB connectors and feed-through terminals fulfil the requirements of AC and DC rated voltages up to 1000 V.

### 9 RockStar® heavy-duty connectors

RockStar® heavy-duty connectors ensure the safe and reliable transmission of power, signals and data in industrial environments, both inside the control cabinet and outside in the field. Locks for selected plug-in connectors fulfil the requirements of the VDE SPEC 90037 up to level 3, i.e. allowing extended deliberate unlocking with a standard specialist tool.

### Workshop & Accessories

Practical advantages for optimised work processes. Professional tools, printing solutions, markers, industrial luminaires and accessories for the highest demands.

E

DC ready

# Solve decentralised automation tasks economically.

## Function-orientated solutions with FieldPower® for DC Microgrids

Simple system planning, fast and error-free installation and reliable operation of widely branched, modular systems are also possible for DC Microgrids with our proven FieldPower® system.

In addition to established control cabinet functions such as feeding, switching, protecting and monitoring, the controlled precharging of sectors and secure decentralised power distribution in the field are also possible.

With FieldPower® and our DC ready portfolio, we develop custom-tailored solutions alongside you for your decentralised power distribution. Please contact us for more details.

E

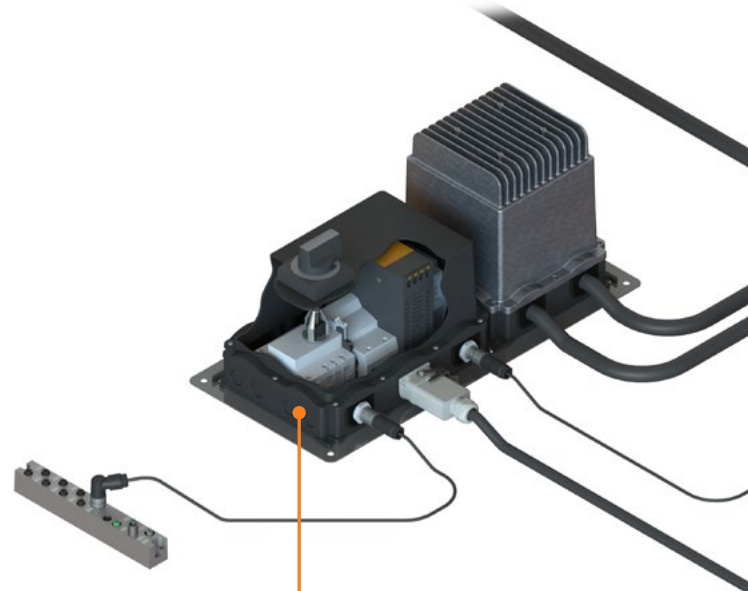

### Sector feed box

DC bus distributor 16 mm<sup>2</sup> and sector feed 6 mm<sup>2</sup> with precharging, bridging, short-circuit & line protection and load disconnection, optionally with DCDC converter 24 V DC for auxiliary power supply



For further information, technical specifications or additional services, please visit our website:  
[www.weidmueller.com/fieldpower](http://www.weidmueller.com/fieldpower)

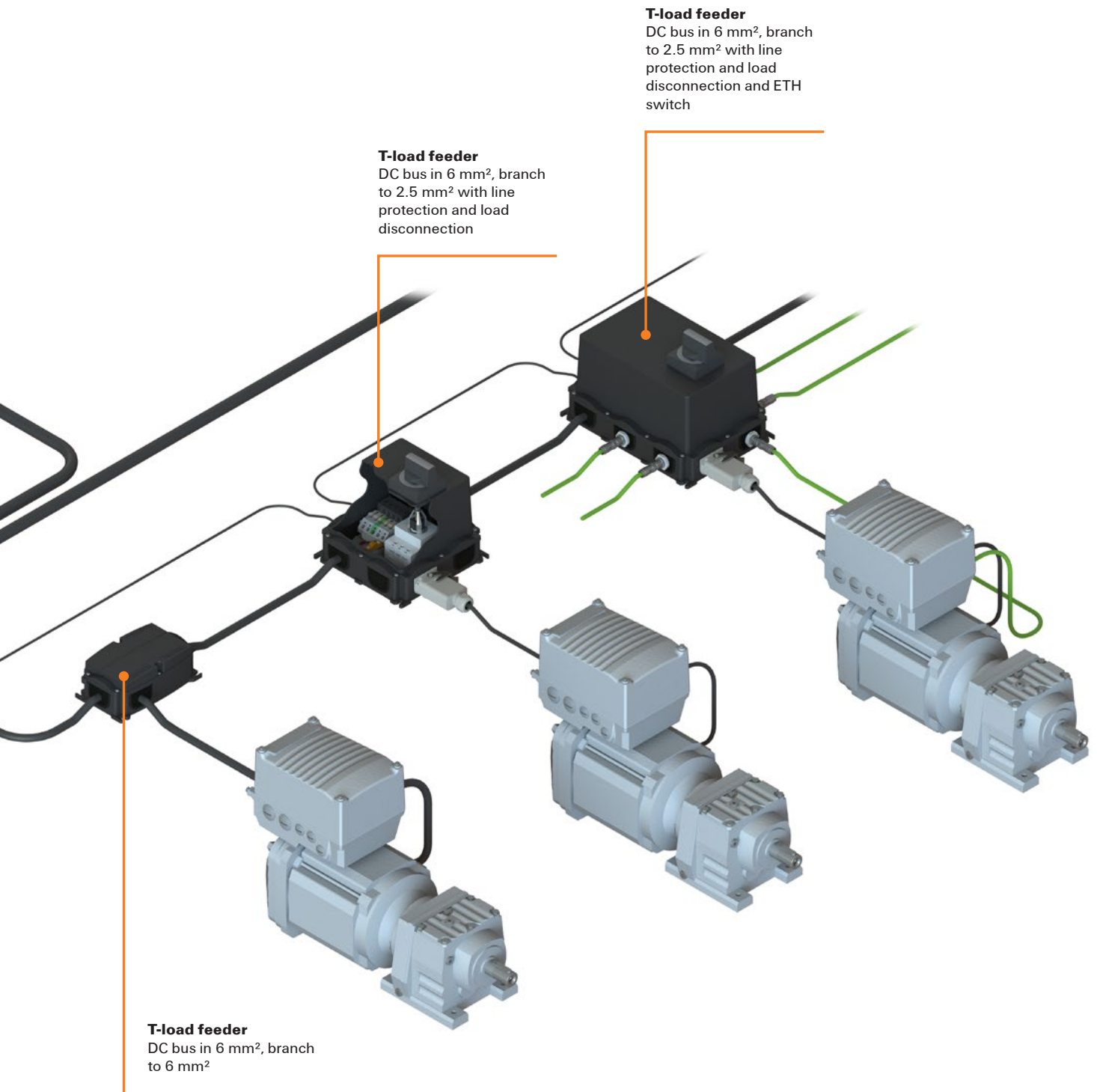

## Testing and safe disconnection

### Two-pole voltage tester for safety-relevant DC voltages up to 1,500 V

Size isn't everything. That is why we have made our new generation of two-pole voltage testers even more compact and powerful. In addition to their proven functions, they offer a range of innovative features. The VT Digi Pro now makes it possible to test up to 1,000 V AC and 1,500 V DC. It not only measures voltage, rotating field, and continuity, but also frequency and resistance. And best of all: the tester can also be operated with one hand. So you always have everything under control.



E



Type	Version	Qty	Order No.
VT DIGI PRO	Testing tools, 2-pole voltage tester type 1152	1	9918870000



## Shaping a smarter energy future. Today.

### DC energy solutions with suitably combined products

Controlling the power flow in a DC microgrid is important in order to reduce the feed-in power and plan energy availability. With the combination of current transducer, signal converter (voltage measurement) and the u-control, the power flows of the DC sectors are under control. The addition of parameters such as PV forecast and electricity price from the exchange ensures highly economical operation of the application.

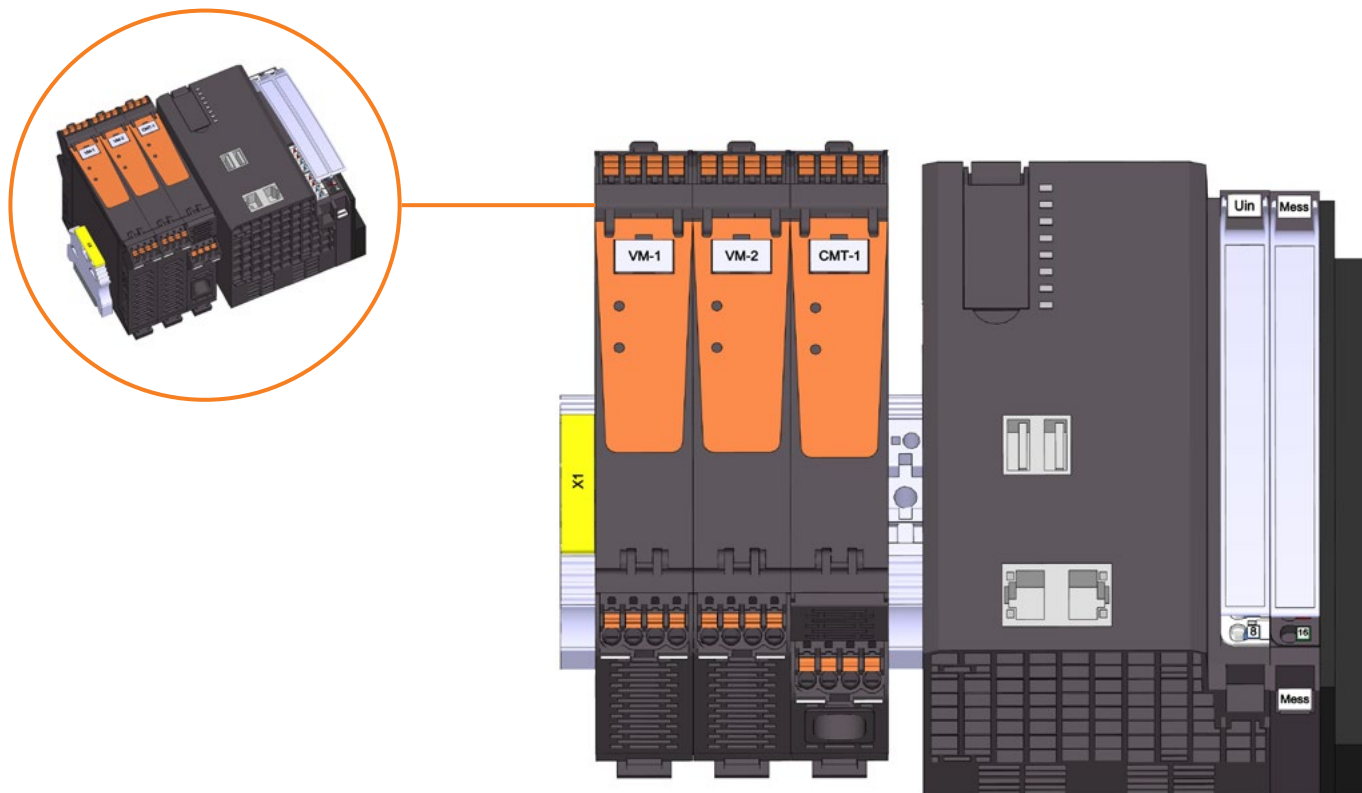

E

DC ready

#### Parts list application

Type	Version	Qty	Order No.
ACT20P-CMT-60-A0-RC-P	Current-measuring transducer, Limit value monitoring, Input : 0...40/50/60 A, Analogue output, Relay output, Current-carrying cable in feed-through hole	1	1510290000
ACT20P-VM-A0-P	Analogue isolating amplifier, Input : AC/DC voltage, 0...600 V DC, 0...440 V AC, Output : 0-10 V, 0(4)-20 mA, Signal converter/isolator	2	7760054360
UC20-M3000	Controller, IP20, AutomationController	1	2839150000
UR20-4AJ-UJ-16	Remote I/O module, IP20, 4-channel, Analog signals, Input, Current/Voltage, 16 Bit	1	1315620000
UR20 EB ACC BK	End bracket	1	1346610000



### Isolating amplifier and measuring transducer

ACT20 signal inverters and current transducers measure and monitor direct and alternating currents in a wide range of industrial zones. Thanks to their effective value measurement, they can detect both sinusoidal and distorted alternating currents, along with direct currents. For direct currents, the direction of flow of the current can also be determined via rapid averaging. They can be used, for instance, to control the power flows for DC networks, which require continuous power calculation based on a DC sector current and voltage measurement. In addition, such sections of the DC network can also be monitored for unbalance via measurements of phase voltages as well as voltages after PE. Unbalance monitoring can indicate defective equipment, preventing accelerated ageing of other devices due to increased load on the insulation.



Nutzen Sie für weitere Produkte, Informationen, technische Angaben oder auch zusätzliche Services unsere Website: [www.weidmuller.com/as-product-overview](http://www.weidmuller.com/as-product-overview)



#### ACT20P – Signal converter and process monitoring for industrial applications

Type	Version	Qty	Order No.
ACT20P-VM-A0-P	Signal converter/insulator, Input: AC/DC voltage, 0...600 V DC, 0...440 V AC, Output: 0-10 V, 0(4)-20 mA, Signal converter/isolator	1	7760054360
ACT20P-CMT-10-A0-RC-P	Current-measuring transducer, Limit value monitoring, Input : 0...5/10 A, Analogue output, Relay output, Current-carrying cable in feed-through hole	1	1510330000
ACT20P-CMT-30-A0-RC-P	Current-measuring transducer, Limit value monitoring, Input : 0...20/25/30 A, Analogue output, Relay output, Current-carrying cable in feed-through hole	1	1510320000
ACT20P-CMT-60-A0-RC-P	Current-measuring transducer, Limit value monitoring, Input: 0...40/50/60 A, Analogue output, Relay output, Current-carrying cable in feed-through hole	1	1510290000



#### ACT20C – Network-compatible current measuring transducers

Type	Version	Qty	Order No.
ACT20C-GTW-100-MTCP-S	Gateway for ACT20C station, Configurable, Modbus TCP/IP, Distributes supply voltage to rail bus	1	1510370000
ACT20C-CMT-10-A0-RC-S	Current-measuring transducer, Input : 0...5/10 A, Output : 0(4)-20 mA, 0-10 V, Relay	1	1510240000
ACT20C-CMT-60-A0-RC-S	Current-measuring transducer, Input : 0...40/50/60 A, Output : 0(4)-20 mA, 0-10 V, Relay	1	1510420000
ACT20C-LBT-10	Bus termination terminal for ACT20C station, Input : 0...40/50/60 A, Output : Pulse	1	1510340000





## Power supplies

Our product families offer multiple advantages. The three power classes and various system accessories have a modular design and thus offer customised solutions. With our power supply components, you can find exactly the product you need. Our switched-mode power supplies in the three performance classes PROtop, PROmax and PROeco offer a high degree of safety and easily withstand harsh industrial environments. They can be operated on both AC and DC networks.



For further products, information, technical specifications or additional services, please visit our website:  
[www.weidmuller.com/powermanagement](http://www.weidmuller.com/powermanagement)

### Load monitoring topGUARD with communication

Type	Version	Qty	Order No.
TGD FIM-C	Supply module	1	2625000000
TGD ELM-12	Electronic load monitoring	1	2624990000
TGD ELM-6	Electronic load monitoring	1	2624980000
TGD ELM-4 CL2	Electronic load monitoring	1	2656670000



### Load monitoring maxGUARD without communication

Type	Version	Qty	Order No.
AMG DIS	Potential distributor	10	2123050000
AMG MD	Potential distributor	10	2122930000
AMG OD	Potential distributor	10	2122910000
AMG PD	Potential distributor	10	2122920000



### Communication modules

Type	Version	Qty	Order No.
PRO COM IO-LINK	Communication module	1	2587360000
PRO COM CAN OPEN	Communication module	1	2467320000





## Terminal blocks – Klippon® Connect: The perfect solution for your DC microgrid

Our Klippon® Connect terminal blocks are the ideal choice for use in DC microgrids. DC microgrids work with a voltage of up to 800 V. This voltage can be applied by all standard terminals above a rated cross-section of 2.5 mm<sup>2</sup>. That means our terminals are DC ready, and offer the flexibility and robust design you need for your DC microgrid projects.



For further products, information, technical specifications or additional services, please visit our website:  
[www.weidmuller.com/terminal-blocks](http://www.weidmuller.com/terminal-blocks)



### Feed-through terminal blocks (S-series)

Type	Version	Qty	Order No.
SL2C 6	Feed-through terminal block, SNAP IN, dark beige, 6 mm <sup>2</sup> , 41 A, 1000 V, Number of connections: 2	50	3037380000
SL3C 6	Feed-through terminal block, SNAP IN, dark beige, 6 mm <sup>2</sup> , 41 A, 1000 V, Number of connections: 3	50	3037410000
SL4C 6	Feed-through terminal block, SNAP IN, dark beige, 6 mm <sup>2</sup> , 41 A, 1000 V, Number of connections: 4	50	3037440000
SL2C 10	Feed-through terminal block, SNAP IN, dark beige, 10 mm <sup>2</sup> , 57 A, 1000 V, Number of connections: 2	50	3037500000
S2C 2.5	Feed-through terminal block, SNAP IN, dark beige, 2.5 mm <sup>2</sup> , 24 A, 800 V, Number of connections: 2	100	2674530000
S3C 2.5	Feed-through terminal block, SNAP IN, dark beige, 2.5 mm <sup>2</sup> , 24 A, 800 V, Number of connections: 3	100	2674540000
S4C 2.5	Feed-through terminal block, SNAP IN, dark beige, 2.5 mm <sup>2</sup> , 24 A, 800 V, Number of connections: 4	100	2674550000
S2C 4	Feed-through terminal block, SNAP IN, dark beige, 4 mm <sup>2</sup> , 32 A, 1000 V, Number of connections: 2	50	2874820000
S3C 4	Feed-through terminal block, SNAP IN, dark beige, 4 mm <sup>2</sup> , 32 A, 1000 V, Number of connections: 3	50	2874840000
S4C 4	Feed-through terminal block, SNAP IN, dark beige, 4 mm <sup>2</sup> , 32 A, 1000 V, Number of connections: 4	50	2874860000
S2T 2.5	Multi-tier modular terminal, SNAP IN, dark beige, 2.5 mm <sup>2</sup> , 800 V, 800 V, Number of connections: 4, Number of levels: 2, TS 35, V-0, Wemid	50	2902380000
S2T 2.5 FT-PE	Multi-tier modular terminal, SNAP IN, dark beige, 2.5 mm <sup>2</sup> , 800 V, 800 V, Number of connections: 4, Number of levels: 2, TS 35, V-0, Wemid	50	2902410000
S2T 2.5 N-FT	Multi-tier modular terminal, SNAP IN, dark beige, 2.5 mm <sup>2</sup> , 800 V, 800 V, Number of connections: 4, Number of levels: 2, TS 35, V-0, Wemid	50	2902420000
S2T 2.5 VL	Multi-tier modular terminal, SNAP IN, dark beige, 2.5 mm <sup>2</sup> , 800 V, 800 V, Number of connections: 4, Number of levels: 2, TS 35, V-0, Wemid	50	2902430000

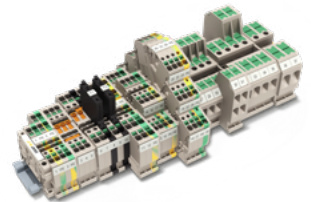

### Feed-through terminal blocks (A-series)

Type	Version	Qty	Order No.
A4C 2.5	Feed-through terminal, PUSH IN, 2.5 mm <sup>2</sup> , 800 V, 24 A, dark beige	100	1521690000
A4C 4	Feed-through terminal, PUSH IN, 4 mm <sup>2</sup> , 800 V, 32 A, dark beige	50	2051500000
A4C 6	Feed-through terminal, PUSH IN, 6 mm <sup>2</sup> , 800 V, 41 A, dark beige	50	2881450000
A3C 10	Feed-through terminal, PUSH IN, 10 mm <sup>2</sup> , 1000 V, 57 A, dark beige	25	2490520000
A3C 16	Feed-through terminal, PUSH IN, 16 mm <sup>2</sup> , 1000 V, 76 A, dark beige	20	2494090000
A2C 35	Feed-through terminal, PUSH IN, 35 mm <sup>2</sup> , 1000 V, 125 A, dark beige	10	2551510000
A2C 35 BL	Feed-through terminal, PUSH IN, 35 mm <sup>2</sup> , 1000 V, 125 A, blue	10	2552090000
A2C 35 PE	PE terminal, PUSH IN, 35 mm <sup>2</sup> , 1000 V, Green/yellow	10	2551520000
AAC 35 2X6	Auxiliary connection (terminal), 6 mm <sup>2</sup> , Number of connections: 2	5	2583090000
AAC 35 2X6 BL	Auxiliary connection (terminal), 6 mm <sup>2</sup> , Number of connections: 2	5	2583170000
AAC 35 2X6 GN-YL	Auxiliary connection (terminal), 6 mm <sup>2</sup> , Number of connections: 2	5	2583180000
A2C 50/70	Feed-through terminal, PUSH IN, 50 mm <sup>2</sup> , 1000 V, 150 A, dark beige	5	2663250000
A2C 50/70 BL	Feed-through terminal, PUSH IN, 50 mm <sup>2</sup> , 1000 V, 150 A, blue	5	2663260000
A2C 50/70 PE	PE terminal, PUSH IN, 50 mm <sup>2</sup> , Green/yellow	5	2663280000
AAC 50-185 2X10	Auxiliary connection (terminal), 10 mm <sup>2</sup> , Number of connections: 2	5	2663420000
AAC 50-185 2X10 BL	Auxiliary connection (terminal), 10 mm <sup>2</sup> , Number of connections: 2	5	2663430000
AAC 50-185 2X10 GN-YL	Auxiliary connection (terminal), 10 mm <sup>2</sup> , Number of connections: 2	5	2663440000
A2C 95/120	Feed-through terminal, PUSH IN, 95 mm <sup>2</sup> , 1000 V, 232 A, dark beige	5	2694060000
A2C 95/120 BL	Feed-through terminal, PUSH IN, 95 mm <sup>2</sup> , 1000 V, 232 A, blue	5	2694070000
A2C 95/120 PE	PE terminal, PUSH IN, 95 mm <sup>2</sup> , 1000 V, Green/yellow	5	2694090000
A2C 150/185	Feed-through terminal, PUSH IN, 150 mm <sup>2</sup> , 1000 V, 309 A, dark beige	5	2728700000
A2C 150/185 BL	Feed-through terminal, PUSH IN, 150 mm <sup>2</sup> , 1000 V, 309 A, blue	5	2728710000



**Power feed-in terminal blocks**

Type	Version	Qty	Order No.
ALO 16	Supply terminal, PUSH IN, 16 mm <sup>2</sup> , 800 V, 76 A, dark beige	20	2502280000
ALO 6	Supply terminal, PUSH IN, 6 mm <sup>2</sup> , 800 V, 41 A, dark beige	20	1991780000
AWPD 35 4X10 BL	Potential distributor terminal, Screw connection, blue, 35 mm <sup>2</sup> , 110 A, 1000 V, Number of connections: 5, Number of levels: 1	20	2860570000
AWPD 35 4X10 BL	Potential distributor terminal, Screw connection, blue, 35 mm <sup>2</sup> , 110 A, 1000 V, Number of connections: 5, Number of levels: 1	20	2860570000
AWPD 35 4X10 FE	Potential distributor terminal, Screw connection, black/yellow, 35 mm <sup>2</sup> , 110 A, 1000 V, Number of connections: 5, Number of levels: 1	20	2924990000
AWPD 35 4X6/6X2.5	Potential distributor terminal, Screw connection, dark beige, 35 mm <sup>2</sup> , 110 A, 1000 V, Number of connections: 11, Number of levels: 1	20	2728620000
AWPD 35 4X6/6X2.5 BL	Potential distributor terminal, Screw connection, blue, 35 mm <sup>2</sup> , 110 A, 1000 V, Number of connections: 11, Number of levels: 1	20	2860560000
AWPD 35 4X6/6X2.5 FE	Potential distributor terminal, Screw connection, black/yellow, 35 mm <sup>2</sup> , 110 A, 1000 V, Number of connections: 11, Number of levels: 1	20	2924980000
WSI 4/2	Fuse terminal, Screw connection, black, 4 mm <sup>2</sup> , 10 A, 500 V, Number of connections: 2, Number of levels: 1, TS 35, TS 32	25	1880430000





## Heavy duty connectors – Rockstar®

Rockstar® offers a safe and powerful plug-in connector for high-voltage applications in 650 V voltage ranges – ideal for industrial DC networks. DC hybrid lines (650 V and 24 V) can also be connected. With a robust design, modular flexibility and simple installation, they deliver maximum operational reliability and efficiency

- Safely connect high currents and voltages
- Use DC hybrid lines for decentralised drives
- Resistance to environmental influences and mechanical loads
- Modular and adaptable
- Fast & secure installation
- Lock stages 2 to 3

Trust in proven connection quality for the power supply of the future – with RockStar® plug-in connectors from Weidmüller!



For further products, information, technical specifications or additional services, please visit our website:  
[www.weidmuller.com/rockstar](http://www.weidmuller.com/rockstar)



### RockStar® HighPower: the modular 550 A connector

Type	Version	Qty	Order No.
<b>300 A, 150 mm<sup>2</sup>, plug housing</b>			
HDC IP68 HP 24B T0	HDC enclosures, Size: 8, Protection degree: IP68, IP69K, IP68 (in plugged condition), Plug housing, Clamping yoke connection, Standard	1	1079930000
HDC HP 550 M 150	HDC insert, Pin, Crimp connection, Size: 550	1	1119110000
HDC 24B HP550 MPL3 TYP1	HDC insert, Number of poles: 3, Size: 8	1	1103720000
HDC IP68 24B MD 3M32	HDC enclosures, Size: 8, Protection degree: IP68, IP69K, IP68 (in plugged condition), Cover, Clamping yoke connection, Standard, Size of cable entries: M 32	1	1119980000
VGM32-MS68 15-25 BG	Heavy-duty connectors, Accessories, Cable glands, Brass, nickel-plated	25	1193610000
<b>300 A, 150 mm<sup>2</sup>, surface-mounted housing</b>			
HDC IP68 HP 24B A	HDC enclosures, Size: 8, Protection degree: IP68, IP69K, IP68 (in plugged condition), Bulkhead housing, Clamping yoke connection, Standard	1	1120040000
HDC HP 550 F 150	HDC insert, Female, Crimp connection, Size: 550	1	1079830000
HDC 24B HP550 MPL3 TYP2	HDC insert, Number of poles: 3, Size: 8	1	1103780000
<b>Note</b>	HDC connector / surface-mounted housings 16 to 35 mm <sup>2</sup> are also DC ready		

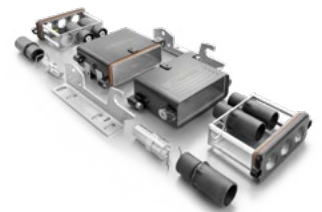

## Size HQ – up to 40 A

Type	Version	Qty	Order No.
<b>HQ4/2 variant 1 for (3G6 +2x2.5) cable</b>			
HDC HQM TOLU 1PG21	HDC enclosures, Size: HQ, Protection degree: IP65 (in plugged condition), Cable entry from top, Plug housing, Side-locking clamp on lower side, Standard, Size of cable entries: PG 21	1	1003080000
VG 21 HQ MS68 14-18	Heavy-duty connectors, Accessories, Cable glands, Brass, nickel-plated	1	1016110000
HDC HQ 4/2 FC	HDC insert, Female, 690 V, 40 A, Number of poles: 6, Crimp connection, Size: HQ	1	1003160000
HDC-C-HD-BM2.5AG	Heavy-duty connectors, Crimp contact, HD, HDD, HQ, MixMate, Female, Conductor cross-section, max.: 2.5, turned, Copper alloy	100	1651610000
HDC C HX BM6.0AG	Heavy-duty connectors, Crimp contact, MixMate, Female, Conductor cross-section, max.: 6, turned, Copper alloy	25	1002980000
HDC HQ 4/2 MC	HDC insert, Male, 690 V, 40 A, Number of poles: 6, Crimp connection, Size: HQ	1	1003170000
HDC-C-HD-SM2.5AG	Heavy-duty connectors, Crimp contact, HD, HDD, HQ, MixMate, Male, Conductor cross-section, max.: 2.5, turned, Copper alloy	100	1651560000
HDC C HX SM6.0AG	Heavy-duty connectors, Crimp contact, MixMate, Male, Conductor cross-section, max.: 6, turned, Copper alloy	25	1002940000
HDC HQP ALU CS	HDC enclosures, Size: HQ, Protection degree: IP65 (in plugged condition), Bulkhead housing, Side-locking clamp on lower side, Standard, lockable: Yes	1	1354950000
BG ARGH HQP ALU PT6 CS	Adapter, Field Power® sealing insert, HQ adapter, IP65, with corresponding enclosure, Polycarbonate, glass fibre reinforced, lockable: Yes	1	1532210000
HDC HQ DC-LOCKLEV 3	HDC - Extension set HQ bracket for lockable surface-mounted housings, extension of the locking level to level 3 (VDE Spec 90037), especially for DC microgrids	1	3103570000
<b>HQ4/2 variant-2 for 3G6 cable</b>			
HDC HQM TOLU 1PG21	HDC enclosures, Size: HQ, Protection degree: IP65 (in plugged condition), Cable entry from top, Plug housing, Side-locking clamp on lower side, Standard, Size of cable entries: PG 21	1	1003080000
VG 21 HQ MS68 14-18	Heavy-duty connectors, Accessories, Cable glands, Brass, nickel-plated	1	1016110000
HDC HQ 4/2 FC	HDC insert, Female, 690 V, 40 A, Number of poles: 6, Crimp connection, Size: HQ	1	1003160000
HDC C HX BM6.0AG	Heavy-duty connectors, Crimp contact, MixMate, Female, Conductor cross-section, max.: 6, turned, Copper alloy	25	1002980000
HDC HQ 4/2 MC	HDC insert, Male, 690 V, 40 A, Number of poles: 6, Crimp connection, Size: HQ	1	1003170000
HDC C HX SM6.0AG	Heavy-duty connectors, Crimp contact, MixMate, Male, Conductor cross-section, max.: 6, turned, Copper alloy	25	1002940000
HDC HQP ALU CS	HDC enclosures, Size: HQ, Protection degree: IP65 (in plugged condition), Bulkhead housing, Side-locking clamp on lower side, Standard, lockable: Yes	1	1354950000
BG ARGH HQP ALU PT6 CS	Adapter, Field Power® sealing insert, HQ adapter, IP65, with corresponding enclosure, Polycarbonate, glass fibre reinforced, lockable: Yes	1	1532210000
HDC HQ DC-LOCKLEV 3	HDC - Extension set HQ bracket for lockable surface-mounted housings, extension of the locking level to level 3 (VDE Spec 90037), especially for DC microgrids	1	3103570000





## Lightning and Surge Protection

DC microgrids are a key component of future power networks. However, these systems are also susceptible to direct lightning strikes and voltage surges, meaning they require a well-designed protection concept. It is essential to protect the sensitive electronics used in these systems. Surge voltages often exceed the dielectric strength of installed electronic components, threatening their integrity. In addition, network-related voltage peaks can damage electronic components.

Implementing a comprehensive, end-to-end surge protection concept is essential to avoid costly repairs and downtime. This approach protects the entire system, guaranteeing the resilience and durability of DC microgrids against unforeseeable external factors.



For further products, information, technical specifications or additional services, please visit our website:

[www.weidmueller.com/surge-protection](http://www.weidmueller.com/surge-protection)



### Lightning and Surge Protection

Type	Version	Qty	Order No.
VPU DC II 3 R 500/40	Surge protection 500 V DC	1	3136610000*
VPU DC II 3 R 1000/40	Surge protection 1000 V DC	1	3136620000*
VPU DC II 3 R 1500/40	Surge protection 1500 V DC	1	3136630000*
PU DC II EV 3 R 1000/40	Surge protection 1000 V DC	1	3136640000*
<b>Note</b>	* available Q4 - 2025		





## Relay modules and solid-state relays – Klippon® Relay

Whether switching, isolating, amplifying or multiplying: relays perform a wide range of different tasks in DC microgrids. Our worldwide unique all-round offer combines maximum relay variety with matching accessories and first-class service. We provide high-quality products that have been thought out down to the smallest detail, combined with comprehensive support from product selection to modern data services.



For further products, information, technical specifications or additional services, please visit our website:  
[www.weidmueller.com/klipponrelay](http://www.weidmueller.com/klipponrelay)

### PSSR half-axle contactor

Type	Version	Qty	Order No.
<b>Solid-state contactor for switching loads up to 1000 V DC 15 A (17.8 mm wide)</b>			
PSSRN K 24VDC 1D K 1000VDC 15A	Power solid-state relay, solid-state contactor, rated control voltage: 4.5...32 V DC, rated switching voltage: 20.4...1000 V DC (IEC), continuous current: 15 A	1	2986930000



### CUBESERIES – Relay modules

Type	Version	Qty	Order No.
<b>CRM miniature industrial relay modules (from 27 mm width)</b>			
CRM40024	CUBESERIES, relay, number of contacts: 4, changeover contact AgNi, rated control voltage: 24 V DC, continuous current: 7 A, Plug connection, test button available: No	10	3052940000
CRM40024T	CUBESERIES, relay, number of contacts: 4, changeover contact AgNi, rated control voltage: 24 V DC, continuous current: 7 A, Plug connection, Test button available: Yes	10	3053010000
CSM P 4CO	CUBESERIES, relay socket, number of contacts: 4, changeover contact, continuous current: 8 A, PUSH IN	10	3053140000
CSM S 4CO	CUBESERIES, relay socket, number of contacts: 4, changeover contact, continuous current: 6 A, screw connection	10	3053160000
CXM CLIP P	CUBESERIES, mounting bracket	10	3053240000
<b>CRI miniature industrial relay modules (16 mm width)</b>			
CRI20024	CUBESERIES, relay, number of contacts: 2, changeover contact AgNi, rated control voltage: 24 V DC, continuous current: 8 A, Plug connection, Test button available: No	10	3052430000
CRI20024T	CUBESERIES, relay, number of contacts: 2, changeover contact AgNi, rated control voltage: 24 V DC, continuous current: 8 A, Plug connection, test button available: Yes	10	3052510000
CSI P 2CO	CUBESERIES, relay socket, number of contacts: 2, changeover contact, continuous current: 8 A, PUSH IN	10	3052570000
CSI S 2CO	CUBESERIES, relay socket, number of contacts: 2, changeover contact, continuous current: 8 A, screw connection	10	3052590000
CXI CLIP P	CUBESERIES, mounting bracket	10	3052710000



### CUBESERIES – Relay modules

Type	Version	Qty	Order No.
<b>Relay modules with forcibly guided contacts (12.8 mm width)</b>			
TRP 24VUC 2CO FG	TERMSERIES, Relay coupler with forcibly guided contacts, Number of contacts: 2, Changeover contact, forcibly guided (EN 61810-3 type B) AgNi, Rated control voltage: 24 V UC ±10 %, Continuous current: 6 A, PUSH IN, Test button available: No	5	2706430000
TRS 24VUC 2CO FG	TERMSERIES, Relay coupler with forcibly guided contacts, Number of contacts: 2, Changeover contact, forcibly guided (EN 61810-3 type B) AgNi, Rated control voltage: 24 V UC ±10 %, Continuous current: 6 A, Screw connection, Test button available: No	5	2706290000



### SAFESERIES – Safety relays

Type	Version	Qty	Order No.
<b>2-channel emergency stop safety relay</b>			
SCS 24VDC P2SIL3ES	SAFESERIES, safety relay, 24 V DC ±15 %, 24 VDC +15 % -10 % with autostart, 35 mA, 5, SIL 3, DIN EN 61508, EN ISO 13849-1 (PLe)	1	1319280000
<b>Note</b>	For a contact extension of the 2-channel safety relay, look in the eshop for the SAFESERIES Contact Extension with forcibly guided contacts in the contact versions 2 NO + 2 NC, 3 NO + 1 NC, 4 NO + 2 NC, 3 NO + 3 NC and 5 NO + 1 NC		



## Solutions for Photovoltaic Systems

Renewable energy sources like photovoltaics can be integrated into DC microgrids simply and highly efficiently, making them a key sector in power generation. The PV sector is integrated into the DC network via a DC/DC converter to adapt the voltage level. We offer an extensive range of PV combiner boxes, surge protection devices, connectors, tools and components for PV installation between the module and DC/DC converter.

For more information about our photovoltaics product range, please see section B of this catalogue.



For further products, information, technical specifications or additional services, please visit our website:  
[www.weidmueller.com/pv-solutions](http://www.weidmueller.com/pv-solutions)



### DC generator combiner boxes with fuses

Type	Version	Qty	Order No.
PVN DC 3IF 30 1MPP SPD1R WM4 10	Photovoltaics, Combiner Box, PV Next, 1000 V, 1 MPP, 3 Inputs / 3 Outputs per MPP, With fuse holder, Surge protection I / II, WM4C	1	2683070000
PVN DC 3IF 30 1MPP SW SPD1R WM4 10	Photovoltaics, Combiner Box, PV Next, 1000 V, 1 MPP, 3 Inputs / 3 Outputs per MPP, With fuse holder, Surge protection I / II, Switch disconnecter, WM4C	1	2683090000
PVN DC 3IF 30 1MPP SPD1R CG 10	Photovoltaics, Combiner Box, PV Next, 1000 V, 1 MPP, 3 Inputs / 3 Outputs per MPP, With fuse holder, Surge protection I / II, Cable gland	1	2683030000
PVN DC 3IF 30 1MPP SW SPD1R CG 10	Photovoltaics, Combiner Box, PV Next, 1000 V, 1 MPP, 3 Inputs / 3 Outputs per MPP, With fuse holder, Surge protection I / II, Switch disconnecter, Cable gland	1	2683050000
PVN1M116SXF3V101TXPX10	Photovoltaics, Combiner Box, PV Next, 1000 V, 1 MPP, 6 Inputs / 6 Outputs per MPP, With fuse holder, Surge protection I / II, WM4C	1	2737440000
PVN1M116SOF3V101TXPX10	Photovoltaics, Combiner Box, PV Next, 1000 V, 1 MPP, 6 Inputs / 6 Outputs per MPP, With fuse holder, Surge protection I / II, Switch disconnecter, WM4C	1	2737480000
PVN1M116SXF3V100TXPX10	Photovoltaics, Combiner Box, PV Next, 1000 V, 1 MPP, 6 Inputs / 6 Outputs per MPP, With fuse holder, Surge protection I / II, Cable gland	1	2737520000
PVN1M116SOF3V100TXPX10	Photovoltaics, Combiner Box, PV Next, 1000 V, 1 MPP, 6 Inputs / 6 Outputs per MPP, With fuse holder, Surge protection I / II, Switch disconnecter, Cable gland	1	2737530000
PVN DC 3IF 30 2MPP SPD1R WM4 10	Photovoltaics, Combiner Box, PV Next, 1000 V, 2 MPP's, 3 Inputs / 3 Outputs per MPP, With fuse holder, Surge protection I / II, WM4C	1	2683080000
PVN DC 3IF 30 2MPP SW SPD1R WM4 10	Photovoltaics, Combiner Box, PV Next, 1000 V, 2 MPP's, 3 Inputs / 3 Outputs per MPP, With fuse holder, Surge protection I / II, Switch disconnecter, WM4C	1	2683100000
PVN DC 3IF 30 2MPP SPD1R CG 10	Photovoltaics, Combiner Box, PV Next, 1000 V, 2 MPP's, 3 Inputs / 3 Outputs per MPP, With fuse holder, Surge protection I / II, Cable gland	1	2683040000
PVN DC 3IF 30 2MPP SW SPD1R CG 10	Photovoltaics, Combiner Box, PV Next, 1000 V, 2 MPP's, 3 Inputs / 3 Outputs per MPP, With fuse holder, Surge protection I / II, Switch disconnecter, Cable gland	1	2683060000
<b>Note</b>	Simple selection via the Weidmüller product selector: <a href="http://www.weidmueller.com/pvselektor">www.weidmueller.com/pvselektor</a>		



### Fireman Switch

Type	Version	Qty	Order No.
PVN DC 2I 10 1MPP RD WM4 11	Photovoltaics, Combiner Box, Fireman's switch, PV Next, 1 MPP, 2 Inputs / 1 Output per MPP, Remote disconnecter, WM4C, 1100 V	1	2778860000
PVN DC 2I 10 1MPP RD CG 11	Photovoltaics, Combiner Box, Fireman's switch, PV Next, 1 MPP, 2 Inputs / 1 Output per MPP, Remote disconnecter, Cable gland, 1100 V	1	2778850000
PVC DC 2I 10 2MPP RD SPD1R EVO 11	Photovoltaics, Combiner Box, Fireman's switch, PV Next, 1100 V, 2 MPP's, 2 Inputs / 1 Output per MPP, Surge protection I / II, Remote disconnecter, MC4-Evo 2	1	8000098970
PVN DC 2I 10 2MPP RD WM4 11	Photovoltaics, Combiner Box, Fireman's switch, PV Next, 2 MPP's, 2 Inputs / 1 Output per MPP, Remote disconnecter, WM4C, 1100 V	1	2778880000
PVN DC 2I 10 2MPP RD CG 11	Photovoltaics, Combiner Box, Fireman's switch, PV Next, 2 MPP's, 2 Inputs / 1 Output per MPP, Remote disconnecter, Cable gland, 1100 V	1	2778870000



## PV Cable Harnessing

Type	Version	Qty	Order No.
<b>Y-Connector Cables</b>			
PVHYW-XXW+XX06W+15	Photovoltaics, Y-Connector Cable, 1x WM4 C Male, 2x WM4 C Female, 6mm <sup>2</sup> , 1500 V	1	2814180000
PVHYW+XXW-XX06W-15	Photovoltaics, Y-Connector Cable, 1x WM4 C Female, 2x WM4 C Male, 6mm <sup>2</sup> , 1500 V	1	2814190000
PVHYM-XXW+XX06M+15	Photovoltaics, Y-Connector Cable, 1x MC4 Male, 1x WM4 C Female, 1x MC4 Female, 6mm <sup>2</sup> , 1000 V	1	2814200000
PVHYM+XXW-XX06M-15	Photovoltaics, Y-Connector Cable, 1x MC4 Female, 1x WM4 C Male, 1x MC4 Male, 6mm <sup>2</sup> , 1000 V	1	2814210000
PVHYW-XXPXX06W+15	Photovoltaics, Y-Connector Cable, 1x WM4 C Male, 1x Partly stripped cable end, 1x WM4 C Female, 6mm <sup>2</sup> , 1500 V	1	2814220000
<b>X-Connector Cables</b>			
PVHXW-W-W+XX06W+15	Photovoltaics, X-Connector Cable, 2x WM4 C Male, 2x WM4 C Female, 6mm <sup>2</sup> , 1500 V	1	2814240000
PVHXW+W+W-XX06W-15	Photovoltaics, X-Connector Cable, 2x WM4 C Female, 2x WM4 C Male, 6mm <sup>2</sup> , 1500 V	1	2814250000
PVHXM-M-W+XX06M+15	Photovoltaics, X-Connector Cable, 2x MC4 Male, 1x WM4 C Female, 1x MC4 Female, 6mm <sup>2</sup> , 1000 V	1	2814260000
PVHXM+M-W-XX06M-15	Photovoltaics, X-Connector Cable, 2x MC4 Female, 1x WM4 C Male, 1x MC4 Male, 6mm <sup>2</sup> , 1000 V	1	2814270000
PVHXW-W-PXX06W+15	Photovoltaics, X-Connector Cable, 2x WM4 C Male, 1x Partly stripped cable end, 1x WM4 C Female, 6mm <sup>2</sup> , 1500 V	1	2814280000
PVHXW+W-PXX06M-15	Photovoltaics, X-Connector Cable, 2x WM4 C Female, 1x Partly stripped cable end, 1x WM4 C Male, 6mm <sup>2</sup> , 1500 V	1	2814290000



## PV Cable Harnessing

Type	Version	Qty	Order No.
<b>Field connectors</b>			
PV-STICK SET	Photovoltaics, Plug-in connector	1	1422030000
PV-STICK- VPE50	Photovoltaics, Plug-in connector	50	1303500000
PV-STICK+ VPE50	Photovoltaics, Plug-in connector	50	1303460000



## Fuses with holder

Type	Version	Qty	Order No.
FUSEHOLDER WSFH 10X38 1KV	Photovoltaics, Fuse holder, 1000 V, 10x38, 1 String, Without LED	10	2827940000
FUSE 10X38 1A 1000 VDC GPV	Photovoltaics, Cartridge fuse, 1000 V, 10x38, gPV, 1 A	10	2783160000
FUSEHOLDER WSFH 10X85 1K5V	Photovoltaics, Fuse holder, 1500 V, 10x85	10	4000002613
FUSE WSFL 10X85 15A 1K5V GPV	Photovoltaics, Cartridge fuse, 1500 V, 10x85, gPV, 15 A	50	4000002597
FUSEHOLDER WSFH 22X58 1K5V 80A	Photovoltaics, Fuse holder, 1500 V, 22x58, Without LED	6	4000003740
FUSE WSFL 22X58 30A 1K5V GPV	Photovoltaik, Schmelzsicherungseinsatz, 1500 V, 22x58, gPV, 30 A	10	2873880000





## Powerful PCB connectors for DC microgrids

Our OMNIMATE Power portfolio offers compact designs, high current-carrying capacity, and reliable contact technology – ideal for modern DC applications. Developed for efficiency, safety and durability in challenging DC infrastructures.

Plug-in connectors have to guarantee high power and current capacity, low power loss and secure contacting. Protection against electric arcs and misconnection, as well as high mechanical and thermal durability, are also essential (locking stages 2 to 3).



For further products, information, technical specifications or additional services, please visit our website:  
[www.weidmuller.com/omnimate](http://www.weidmuller.com/omnimate)

## E



### OMNIMATE® Power IT – 6 mm<sup>2</sup> PCB connectors

Type	Version	Qty	Order No.
BVZ 7.62IT/02/180MF SN BK BX	6 mm <sup>2</sup> connector	52	1156710000
SV 7.62IT/02/90MF2 3.5SN BK BX SO	6 mm <sup>2</sup> header	78	1156540000
SV 7.62IT/02/270MF2 3.5SN BK BX SO	6 mm <sup>2</sup> header	78	1156490000



### OMNIMATE® Power HP – 6mm<sup>2</sup> PCB connectors

Type	Version	Qty	Order No.
BVDF 7.62HP/02/180MF2 SN BK BX	6 mm <sup>2</sup> connector	39	2720550000
SV 7.62HP/02/90MF2 3.5SN BK BX	6 mm <sup>2</sup> header	78	1048390000
SV 7.62HP/02/180MF2 3.5SN BK BX	6 mm <sup>2</sup> header	78	1048350000
SV 7.62HP/02/270MF2 3.5SN BK BX	6 mm <sup>2</sup> header	78	1048370000



### OMNIMATE® Power IT – 16 mm<sup>2</sup> PCB connectors

Type	Version	Qty	Order No.
BUZ 10.16IT/02/180MF AG BK BX	16 mm <sup>2</sup> connector	30	1156600000
SU 10.16IT/02/90MF2 3.5AG BK BX SO	16 mm <sup>2</sup> header	60	1156650000
SU 10.16IT/02/270MF2 3.5AG BK BX SO	16 mm <sup>2</sup> header	60	1157310000



### OMNIMATE® Power – 6 mm<sup>2</sup> PCB terminals

Type	Version	Qty	Order No.
LLF 7.50/01/90 5.0SN BK BX	6 mm <sup>2</sup> terminal	200	2471520000
LLFS 7.50/01/90 5.0SN BK BX	6 mm <sup>2</sup> terminal	200	2473420000
LLFS 7.50/01/180 5.0SN BK BX	6 mm <sup>2</sup> terminal	200	2491110000

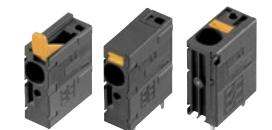

### OMNIMATE® Power – 6 mm<sup>2</sup> PCB terminals

Type	Version	Qty	Order No.
LUFS 10.00/01/90 5.0SN BK BX	16 mm <sup>2</sup> terminal	50	2500560000
LUFS 10.00/01/180 5.0SN BK BX	16 mm <sup>2</sup> terminal	50	2491810000
LUF 15.00/02/90V 5.0SN BK BX	16 mm <sup>2</sup> terminal	40	2492000000
LUFS 15.00/02/180V 5.0SN BK BX	16 mm <sup>2</sup> terminal	40	2491820000
LUFS 15.00/02/90V 5.0SN BK BX	16 mm <sup>2</sup> terminal	40	2499440000



### OMNIMATE® Power – Powerbus

Type	Version	Qty	Order No.
PB-CON 160 S/02/90RFSF AG BK BX	DC Powerbus	20	2594720000
PB-FEED 160 100/02RF AG BK BX	DC Powerbus	10	2595180000
PB-LINK 160 50/02RF AG BK BX	DC Powerbus	20	2595540000



# Explanation of locking stages

- 
- |           |                     |   |   |
|-----------|---------------------|---|---|
| <b>1</b>  | Basic protection    |    | <p><b>Requirement:</b> separate a plug-in connection by disconnecting the plug-in connector without lock.</p> <p><b>Typical applications:</b> inside devices, PCB connectors, Schuko plugs</p> <p><b>When is this required?</b> In applications where accidental disconnection leads to downtimes, but not hazardous situations, this stage provides basic safety without increased maintenance requirements.</p> <p><b>Our solution:</b> plug-in connectors with mechanical resistance.</p>  |
| <hr/>     |                     |   |   |
| <b>2</b>  | By hand             |    | <p><b>Requirement:</b> disconnect a plug-in connection through purposeful manual unlocking (such as a securing bracket or knurled nut)</p> <p><b>Typical applications:</b> classic power distributions on or outside the control cabinet</p> <p><b>When is this required?</b> In applications where purposeful disconnection is required to avoid accidental interruptions, this stage offers additional safety.</p> <p><b>Our solution:</b> plug-in connectors with integrated bracket closure / bracket lock, push-pull plug-in connectors</p>  |
| <hr/>     |                     |   |   |
| <b>3</b>  | Standard tool       |  | <p><b>Requirement:</b> disconnect a plug-in connection via release from a standard tool (such as a screwdriver)</p> <p><b>Typical applications:</b> inside industrial systems and robotic cells, railway engineering, intralogistics</p> <p><b>When is this required?</b> Protects against unauthorised or accidental disconnection in areas with increased safety requirements.</p> <p><b>Our solution:</b> plug-in connectors with screw plug locking, device connector with screw-in central flange locking</p>  |
| <hr/>     |                     |   |   |
| <b>4</b>  | Key                 |  | <p><b>Requirement:</b> disconnect a plug-in connection via release through an authorised key (such as lockable safety bracket, NFC) or a special tool</p> <p><b>Typical applications:</b> inside industrial systems and robotic cells, railway engineering, intralogistics</p> <p><b>When is this required?</b> In areas with increased safety regulations or the possibility of access by untrained personnel, this stage protects against unauthorised and uncontrolled disconnection.</p> <p><b>Our solution:</b> plug-in connectors with key and lock or electronic release function.</p>   |
| <hr/>     |                     |   |   |
| <b>5a</b> | Signal control      |  | <p><b>Requirement:</b> disconnect a plug-in connection via automatic release by authorised opening (voltage measurement in control cabinet) through a signal to a plug-in connector</p> <p><b>Typical applications:</b> automated industrial systems, DC microgrids, maintenance systems with remote release</p> <p><b>When is this required?</b> Prevents disconnection under load, increases operational reliability and protects personnel and systems. Especially in areas accessible to the public and system-critical components (such as frequency converters outside of a robotic cell)</p> <p><b>Our solution:</b> Intelligent plug-in connectors with controller interfaces and electronic locking mechanism. Ensure absence of voltage through a built-in LED (safety rule 3).</p> |
| <hr/>     |                     |   |   |
| <b>5b</b> | Auto-nomous release |  | <p><b>Requirement:</b> disconnect a plug-in connection via automatic release by authorised opening (voltage measurement in control cabinet).</p> <p><b>Typical applications:</b> automated industrial systems, DC microgrids, maintenance systems with remote release</p> <p><b>When is this required?</b> Allows for safe maintenance and prevents unauthorised disconnection through an automated release system. Especially in areas accessible to the public and system-critical components (such as frequency converters outside of a robotic cell)</p> <p><b>Our solution:</b> Intelligent plug-in connectors with voltage measurement module and electronic locking mechanism. Ensure absence of voltage through a built-in LED (safety rule 3).</p>                                   |

# DC Innovation Hub at the Weidmüller Academy

## Where innovation meets application: direct current solutions for continuous operation

Weidmüller is setting a forward-thinking standard with its new DC Innovation Hub in Detmold, designed to bridge technological innovation and hands-on training. The DC Innovation Hub is aimed equally at customers, users, and partners, providing a space where they can explore and test direct current technologies through pilot projects. This hub impresses with its holistic approach: Weidmüller integrates applications, products, innovations, and training solutions, creating a seamless transition from technology to practical use in everyday working life.

E

As a pioneer in direct current (DC) technology, Weidmüller has made this project a priority. Over the coming years, the DC Microgrid at the Detmold site will be gradually expanded to fully leverage the benefits of DC technology: higher energy efficiency due to reduced conversion losses, lower peak loads, the efficient integration of renewable energies such as photovoltaics, and ultimately, improved grid stability.

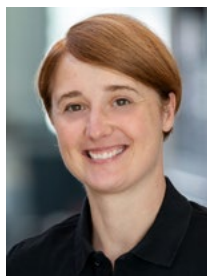

»By integrating DC technologies, we not only create modern learning environments but also empower our trainees and employees to actively shape the future of energy supply. Our goal is to tightly intertwine innovation and practice, thereby making a crucial contribution to the industry of tomorrow.«

Romina Kehl, Head of Education at Weidmüller



### Clear Objective: A Platform for Synergies and Future-Focused Growth

With the DC Innovation Hub, Weidmüller aims to create a central platform where all stakeholders in the field of DC networks can come together—encompassing training, development, and practical application for customers. The focus is on planning, designing, and implementing the entire DC network. In this way, Weidmüller aims to provide users and customers well-grounded guidance on DC applications.

Beyond the technological advantages of a DC Microgrid, such as increased energy efficiency and network quality, the primary goal has been to create a space that fosters the exchange of ideas, collaborative development of new technologies, and practical implementation of solutions. By integrating both existing and future Weidmüller technologies, synergies are created, and innovation processes are accelerated, benefiting employees and customers alike. Weidmüller sees itself as a technological driver in the field of DC Microgrids and aims to establish these as the primary energy grids of the future. The company places particular emphasis on a holistic approach that puts applications, products, and innovations directly into practice.



The design of the DC network at the Weidmüller Academy began with a comprehensive energy analysis of the existing AC infrastructure.



We want to bring the knowledge we accumulate here through training, maintenance, and development directly to our customers as solutions.

Olaf Grünberg, DC Project Manager at Weidmüller

The scope of Weidmüller's DC Microgrid at the Detmold site is impressive: "We are capable of supplying a DC grid with 150 kW here," explains Grünberg, adding, "We identified the peak load of the machines on site by putting all our equipment into operation. We identified the peak load of the machines on site by putting all our equipment into operation. This resulted in a demand of 130 kW—equivalent to that of a well-utilised medium-sized company." Over the next three years, the DC Microgrid will be expanded incrementally, with continuous focus on infrastructure and the integration of energy consumers as well as sources such as photovoltaic systems and energy storage.

### Precise Planning as the Foundation for a Safe and Efficient DC Network

The foundation of DC technology is the so-called System Description, developed in close collaboration with industry partners and application-based research. This description serves as a specific guideline for the operation of DC Microgrids and is intended to become a standard in the future. Given the unique aspects of DC technology, particularly concerning personnel and equipment safety, security plays a central role in planning and implementation.

The design of the DC Microgrid at the Weidmüller Academy began with a comprehensive energy analysis of the existing AC infrastructure, based on current operations and potential scenarios. Based on these insights, Weidmüller's DC experts conducted a machine analysis and developed a conversion plan to ensure that the Academy's current machinery is suitable for the transition to DC. In close coordination with the local energy supplier, a specification was created and tenders prepared. Simultaneously, the sector planning was developed, and the cabinet builder and installation partner was deeply involved through technical onboarding.



E



**Reliable Integration: Detailed Installation of the DC Infrastructure**

The new infrastructure was installed in close coordination, with technical onboarding provided by the cabinet builder and the installation partner. Weidmüller partnered with AGW Elektrotechnik from Georgsmarienhütte as a reliable integration partner to ensure smooth execution. The focus of the work was on installing the boxes and infrastructure in the field and translating sector planning into practical infrastructure. Both the line distribution and the junction boxes were successfully implemented.

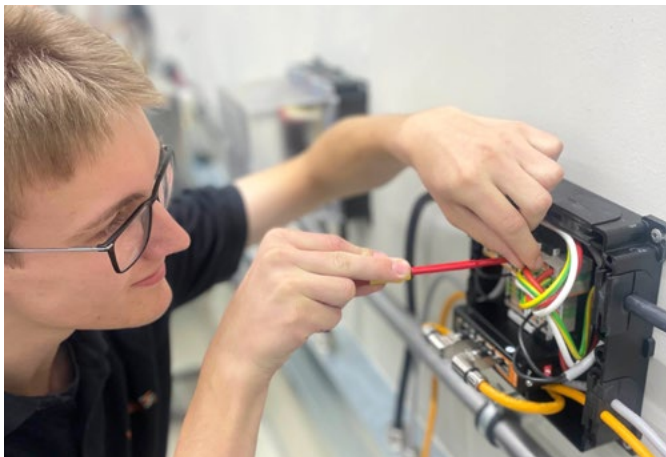

Installing infrastructure (junction boxes) in the field

A central element was the direct integration of high-powered devices such as photovoltaic systems, storage systems, and electric vehicles into the DC bus. For this integration, two special cabinets were installed: one for AC input and AC/DC rectification. This cabinet filters and rectifies the incoming alternating current from the energy supplier to provide clean direct current and handle application currents (common mode). The second cabinet is responsible for power distribution within the system.

Weidmüller was able to rely on its comprehensive portfolio of standard components and specific DC solutions that are “DC ready” and meet VDE standards and the quasi-standard of the DC System Description. These components were carefully selected and tested to meet the safety and reliability requirements of DC Microgrids.

Protection, distribution, and power supply, together with precharging, measurement technology, and precise power flow control, were essential steps to ensure smooth operation. Following a successful electrical inspection and approval, the new infrastructure was commissioned at the Weidmüller Academy on schedule.

**IDC Microgrid 1.0: The Future of Energy Supply at Weidmüller**

The first phase of the DC Microgrid, now implemented as a fully operational direct current grid, is in place at the Weidmüller Academy. Nine DC sectors, each with a capacity of 13 kW, now power the machines in the training workshop facility. In the coming years, the entire workshop will be converted to DC technology to integrate all relevant machines into the grid. These developments feed directly into the training and educational programmes of the Detmold-based family business.

However, the DC Innovation Hub represents more than just technological progress; it also provides customers and users with the opportunity to experience the potential uses and applications of DC technology—including pilot projects and testing for their own applications. With this future-focused initiative, Weidmüller strengthens its role as a pioneer in energy supply, actively involves customers and partners, and bolsters the skills of its employees to tackle the challenges of tomorrow.



# Energy management

<b>Energy management</b>	ResMa® Resource and energy management	F.2
	ResMa® - Basic and ResMa® Package extensions	F.4
	ResMa® Evaluation Kit	F.6
	Overview - PROCON-Connect	F.8
	PROCON-WEB Embedded Systems	F.10
	PROCON-WEB SCADA	F.14

# ResMa® Software for process and energy optimization

## Optimize your processes with the intelligent energy management that can be combined to Industrial IoT

The use of energy and resources is a cost factor that grows with increasing automation and is having an increasing impact on industrial production. By linking resource and energy management with Industrial IoT, we create the transparency needed to make your processes more sustainable and economical. The resource and energy management software ResMa® combines the analysis of energy and process data with Industrial IoT platform solutions and offers an integrated system to merge and analyse comprehensive data centrally and to use the knowledge for the optimisation of processes or for new services.

The modular and preconfigured system variants for the standard ResMa® use cases enable the flexible and fast implementation of your projects, whether in production, industry or distributed infrastructures. In addition, open interfaces allow simple and cost-effective integration into the existing IT environment. We enable you to make optimal use of your data, uncovering potential and increasing your productivity.



For more information, visit our website:  
[www.weidmueller-gti-software.com](http://www.weidmueller-gti-software.com)

### Your benefits at a glance



#### Recording of production data

The simple collection of data from different machines and systems enables the collection of production data. Thus, complex key figures can be calculated and plausibility can be configured to optimize production processes.



#### Reduction of costs

With our solutions, energy and process data become meaningful key figures. In this way, you not only reduce costs, but also optimize your processes, increase availability and reduce the use of resources.



#### Automatic reporting

For standardized reporting, individual energy reports or production-relevant evaluations can be sent automatically. In addition, the interactive documentation within the system supports the exchange of information between users.



#### Real-time alerting

States, limit or set values are continuously monitored and show abnormalities in order to avoid downtimes and increase OEE. This information can be conveniently forwarded to users.



#### Simple system integration

Flexible integration of different measurement systems, industrial controllers or other data sources through communication drivers (like Modbus or OPC-UA) and open interfaces. Data exchange with ERP/MES systems or other databases is also easy to implement.



#### Certified acc. to ISO 50001

DIN EN ISO 50001 compliant energy management certified by the TÜV-Süd (German Technical Inspectorate) and listed at the BAFA. ResMa® allows for simple documentation of energy saving measures with subsequent monitoring and final analysis.

ResMa® offers comprehensive analysis options to identify energy and process-based potentials, document them and derive measures for optimization. Power and production data are collected and prepared in ResMa®. Display options like Sankey diagrams, comprehensive reports or options to compare time periods provide maximum transparency.

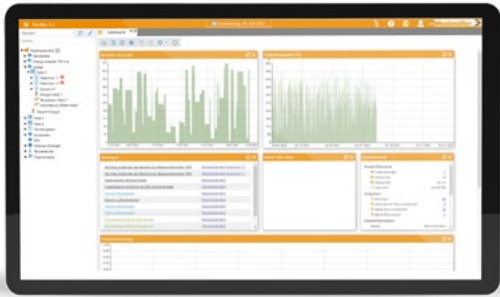

### Transparency of production

Simple acquisition of all measured variables

- Electricity, gas, water, heat, air consumption
- Order-related quantities and material input
- Machine and equipment performance

ResMa® delivers comprehensive values for statistical analysis of all recorded measured variables, such as: Min, Max, Mean, Sum etc.

### Simple and efficient process analysis

Detailed analysis via interactive, adaptable charts for optimal display

- Generation of meaningful key figures including production parameters
- Specific analyses for energy usage and other production parameters



### Less effort, more control

Automated evaluation

- Representation of energy flows via Sankey diagrams
- Use of mobile devices for fast notifications and status queries
- Central monitoring of all production halls or branches for cross-site benchmarking



## ResMa® Basic

### Evaluate data – plan optimizations

Basic package for the preparation, presentation and analysis of data from the production environment

- Identification of weak points and causes with fluctuating process quality
- Documentation of the entire consumption
- Efficient reporting through automated reports
- Simple operability with high functionality at the same time
- Adjustable dashboards for maximum transparency



## F Optionally extend your ResMa® Basic Add-on Packages

Optionally expand your ResMa® Basic. The modular structure allows you to use special and extensive evaluations and analyses. Find the ideal addition to optimise your use case with the ResMa® energy management software and easily gain added value from your data.

### ResMa® Energy Package

DIN EN ISO 50001 certified energy management system



- Continuous monitoring and optimisation of energy usage
- PDCA cycles and documentation functions
- Calculate meaningful energy KPIs and key data
- Automated reporting with custom reporting templates
- Transparent cost calculation with tariff integration

### ResMa® Production Package

For a detailed analysis of machines and systems



- Increase process stability to reduce scrap and increase quality
- Reduce use of resources (material and power) to save costs
- Statistics on the causes of downtime as the basis for a cost analysis
- Increase availability and productivity to maximize profits
- Optimize productivity through cross-location benchmarking on the product level and on an order-specific basis

**ResMa® Regression Analysis Package**

Regression analyses for optimisation and investment decisions

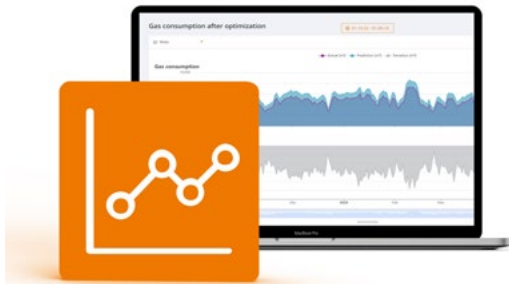

- Find dependencies in data via correlation analyses and thereby boost process understanding and transparency
- Determine the type and strength of dependencies as the basis for optimization and investment decisions
- Create regression models based on dependency findings
- Complete regression analyses based on created models for any time period
- Visualise the effects of optimisation measures on energy and processes

**ResMa® Recipe Management Package**

Documentation, representation and analysis of recipes to improve quality



- Standardisation through the use and exchange of recipes
- Document concrete production processes
- Analyse warning and limit value violations
- Visualise unstable processes early on (connection to LiveValueCache)
- Integrate findings into newly developed recipe versions
- Increase production quality for the long-term

**ResMa® Import Package**

Facilitates imports from third-party systems to evaluate all data in a single system

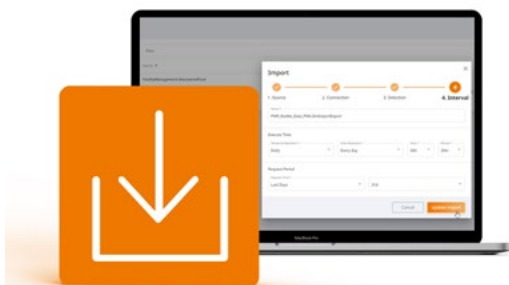

- Browse through external data sources (MS SQL, CSV)
- Map time series data on measurement points
- Configure import jobs
- Automatic cyclical execution
- Automate adoption of time series data from third-party systems

# ResMa® Evaluation Kit

## Test package with comprehensive functions

To get to know the versatile functions of ResMa®, our ResMa® Evaluation Kit provides a cost-effective introduction to recording and evaluating measured values. We would like to make it possible for everyone to use our ResMa® energy management software in the form of a test package in order to make energy management in companies of any size as efficient as possible.



Further information is available on our website:  
<http://wmqr.eu/ResMa-Evaluation-Kit>

F

### Your advantages



**Short delivery times**  
 Hardware and software test package available at short notice



**More efficiency through transparency**  
 Continuous monitoring, analysis and evaluation of your energy data



**Individual introduction**  
 You will receive an introduction to your individual project from our experts



# ResMa<sup>®</sup> Basic & Add-on Packages

## Order overview

The available functions of ResMa<sup>®</sup> are divided into different function packages, allowing you to customise configuration to suit your needs. We will be happy to advise you with the selection and demonstrate the corresponding scope of services of the extension packages.

Type	Number of process variables, max.	Platform for runtime system	Order No.
<b>RESMA</b>			
RESMA-100	100	Windows	3036610000
RESMA-200	200	Windows	3036620000
RESMA-500	500	Windows	3036630000
RESMA-1000	1.000	Windows	3036640000
RESMA-3000	3.000	Windows	3036650000
RESMA-10000	10.000	Windows	3036660000
RESMA-100-ENMS	100	Windows	3036750000
RESMA-200-ENMS	200	Windows	3036760000
RESMA-500-ENMS	500	Windows	3036770000
RESMA-1000-ENMS	1.000	Windows	3036780000
RESMA-3000-ENMS	3.000	Windows	3036790000
RESMA-10000-ENMS	10.000	Windows	3036800000
RESMA-100-PROD	100	Windows	3036670000
RESMA-200-PROD	200	Windows	3036690000
RESMA-500-PROD	500	Windows	3036700000
RESMA-1000-PROD	1000	Windows	3118160000
RESMA-3000-PROD	3.000	Windows	3036720000
RESMA-10000-PROD	10.000	Windows	3036710000
RESMA-100-IMPORT	100	Windows	3029480000
RESMA-200-IMPORT	200	Windows	3029490000
RESMA-500-IMPORT	500	Windows	3029500000
RESMA-1000-IMPORT	1.000	Windows	3029510000
RESMA-3000-IMPORT	3.000	Windows	3029520000
RESMA-10000-IMPORT	10.000	Windows	3029530000
RESMA-100-REZEPTUR	100	Windows	3029540000
RESMA-200-REZEPTUR	200	Windows	3029550000
RESMA-500-REZEPTUR	500	Windows	3029560000
RESMA-1000-REZEPTUR	1000	Windows	3029570000
RESMA-3000-REZEPTUR	3000	Windows	3029580000
RESMA-10000-REZEPTUR	10000	Windows	3118170000
RESMA-100-REGRESSION	100	Windows	3118180000
RESMA-200-REGRESSION	200	Windows	3029610000
RESMA-500-REGRESSION	500	Windows	3029620000
RESMA-1000-REGRESSION	1000	Windows	3029630000
RESMA-3000-REGRESSION	3000	Windows	3029640000
RESMA-10000-REGRESSION	10000	Windows	3029650000
RESMA-MODBUS-CONNECTOR		Windows	2854870000
RESMA-PLC-CONNECTOR		Windows	2854120000
Basic Training			2938790000
Inbetriebnahme [Stunde]			2938840000
Installation Standard			2938810000
Project Coordination			2938820000
SLA Technical Support (PWEB/ResMa)			2938730000
SLA Update (ResMa)			3107540000

# PROCON-Connect

## Simple data acquisition, pre-processing and communication

Our PROCON-Connect enables the acquisition of machine data from a wide variety of controllers. It also allows local pre-processing and the use of machine data in other software systems through connectors and APIs, among other things.

The PROCON-Connect can be used for a wide range of data- and service-oriented Industrial IoT use cases. The connections to controllers, databases and the interfaces to other software solutions are conveniently configured in the browser. In addition to a comprehensive driver portfolio for connecting controllers, the PROCON-Connect uses industry-appropriate standards (such as InfluxDB or MQTT), and makes it possible to use machine data in the Weidmüller solutions ResMa® and easyConnect, among others.

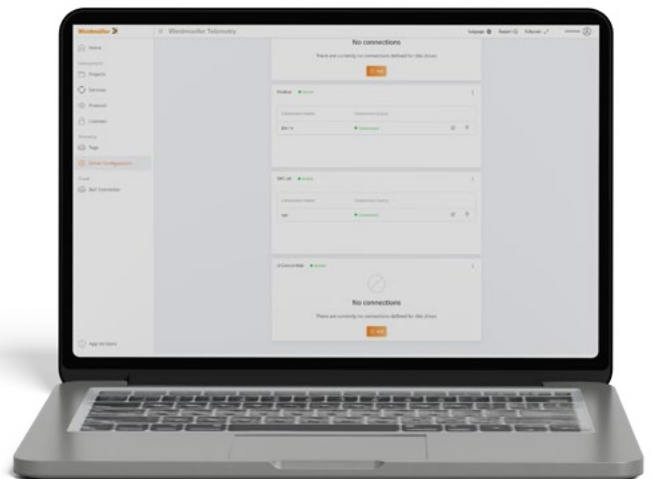

- Drivers with browsing function:  
OPC-UA, ModbusTCP/RTU, CODESYS®, AllenBradley and drivers for u-mation PLC
- Installation of u-OS App Manager or on industrial PCs via Docker container
- Parameterisation of controller connections, databases and cloud connections via browser



For more information, visit our website:  
[www.weidmueller-gti-software.com](http://www.weidmueller-gti-software.com)

### Platform-independent app

Simple installation under u-OS using the App Manager and on any hardware using Docker containers.

### Open standards and interfaces

Communication drivers, database technologies, APIs and cloud interfaces of the PROCON-Connect are based on open standards (e.g. OPC-UA, InfluxDB or MQTT) and, in addition to our APIs, allow seamless integration into the IIoT infrastructure.

### Intuitive web engineering

Our PROCON-Connect can be configured completely in the browser at run-time. It supports engineering with project import and export functionality as well as extensive feedback for the user.

**Ordering data**

Type	Number of process variables, max.	Number of devices	Platform for runtime system	Order No.
P-CON RUN			Windows, Linux, Docker Container	3053900000
P-CON DRV CODESYS			Windows, Linux, Docker Container	3053910000
P-CON DRV ALLENBRADLEY			Windows, Linux, Docker Container	3053920000
P-CON COM 50	50		Windows, Linux, Docker Container	3053930000
P-CON COM 100	100		Windows, Linux, Docker Container	3053940000
P-CON COM 250	250		Windows, Linux, Docker Container	3053950000
P-CON COM 500	500		Windows, Linux, Docker Container	3053960000
P-CON COM 1000	1000		Windows, Linux, Docker Container	3053970000
P-CON COM 2500	2500		Windows, Linux, Docker Container	3053980000
P-CON COM 5000	5000		Windows, Linux, Docker Container	3053990000
P-CON COM 10000	10000		Windows, Linux, Docker Container	3054000000

# Future-proof visualisations for Industrial IoT applications

## PROCON-WEB Embedded Systems – the platform-independent HMI software

In modern Industrial IoT and automation applications, machine data must be available locally and in the cloud for all users. To ensure task-oriented provision and intuitive use, the relevant information needs to be collected and visually prepared.

PROCON-WEB Embedded Systems is a platform-independent visualisation solution ideally suited for use in modern Industrial IoT applications. Thanks to its low system requirements, it can be used on many different devices, and is also available on Weidmüller u-OS family controllers through the App Manager. The HMI is conveniently accessed via HTML5-compatible browsers and can therefore be accessed from a wide variety of end devices.

### Your special advantage:

- Portable and easy-to-parametrise HMI and Industrial IoT solution
- High performance with low resource requirements
- Compatible with devices with OPC-UA server, Modbus interface, CODESYS® and u-OS PLCs
- Dynamic web interface with adaptive design and customisable control elements



For more information, visit our website:  
[www.weidmuller-gti-software.com](http://www.weidmuller-gti-software.com)



**Many visualisation features**

Predefined control elements, user and rights management, multilingualism, data recording, recipe management, alarm and message processing, and many other features make PROCON-WEB Embedded Systems versatile.

**Maximum flexibility**

PROCON-WEB Embedded Systems can be used independently of hardware and operating system. Web-based visualisation, support for mobile devices, and open communication standards increase flexibility.

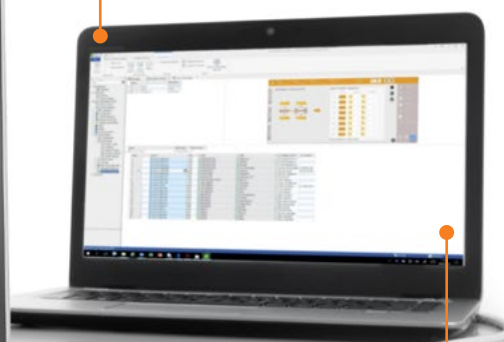
**Efficient project planning**

Project management is accelerated through features like a class-instance concept, structural support and automated project generation. Scripting and customisable control elements increase flexibility for complex requirements.

## PROCON-WEB Embedded Systems – Visualisation solutions for your Industrial IoT applications

### Ordering data

Type	Number of process variables, max.	Number of devices	Platform for runtime system	Order No.
<b>PROCON-WEB Embedded Systems runtime licences</b>				
PWEB-ES-RT-50/2	50	2	Windows, Linux, Docker Container	2992900000
PWEB-ES-RT-50/5	50	5	Windows, Linux, Docker Container	2992910000
PWEB-ES-RT-50/10	50	10	Windows, Linux, Docker Container	2992890000
PWEB-ES-RT-100/2	100	2	Windows, Linux, Docker Container	2992810000
PWEB-ES-RT-100/5	100	5	Windows, Linux, Docker Container	2992820000
PWEB-ES-RT-100/10	100	10	Windows, Linux, Docker Container	2992800000
PWEB-ES-RT-500/2	500	2	Windows, Linux, Docker Container	2992930000
PWEB-ES-RT-500/5	500	5	Windows, Linux, Docker Container	2992940000
PWEB-ES-RT-500/10	500	10	Windows, Linux, Docker Container	2992920000
PWEB-ES-RT-1000/2	1000	2	Windows, Linux, Docker Container	2992840000
PWEB-ES-RT-1000/5	1000	5	Windows, Linux, Docker Container	2992850000
PWEB-ES-RT-1000/10	1000	10	Windows, Linux, Docker Container	2992830000
PWEB-ES-RT-2000/2	2000	2	Windows, Linux, Docker Container	2992870000
PWEB-ES-RT-2000/5	2000	5	Windows, Linux, Docker Container	2992880000
PWEB-ES-RT-2000/10	2000	10	Windows, Linux, Docker Container	2992860000
PWEB-ES-RT-5000/2	5000	2	Windows, Linux, Docker Container	2875320000
PWEB-ES-RT-5000/5	5000	5	Windows, Linux, Docker Container	2875330000
PWEB-ES-RT-5000/10	5000	10	Windows, Linux, Docker Container	2875340000
PWEB-ES-DESIGNER-2000_FREE	2000			3037270000
PWEB-DESIGNER-PRO				2857650000
Basic Training				2938790000
Customer Specific Training				2938800000
SLA Technical Support				2938730000

### Ordering data

Type	Number of process variables, max.	Number of devices	Platform for runtime system	Order No.
<b>PROCON-WEB Embedded Systems runtime licences for u-OS</b>				
U-OS-PWEB-ES-RT-250/1_free	250	1	u-OS	2987740000
U-OS-PWEB-ES-RT-250/2	250	2	u-OS	3038630000
U-OS-PWEB-ES-RT-500/2	500	2	u-OS	2941960000
U-OS-PWEB-ES-RT-500/5	500	5	u-OS	2941970000
U-OS-PWEB-ES-RT-1000/2	1000	2	u-OS	2941980000
U-OS-PWEB-ES-RT-1000/5	1000	5	u-OS	2941990000
U-OS-PWEB-ES-RT-2000/2	2000	2	u-OS	2942000000
U-OS-PWEB-ES-RT-2000/5	2000	5	u-OS	2942010000
U-OS-PWEB-ES-RT-5000/2	5000	2	u-OS	2942020000
U-OS-PWEB-ES-RT-5000/5	5000	5	u-OS	2942030000
U-OS-PWEB-ES-RT-10000/2	10000	2	u-OS	2942040000
U-OS-PWEB-ES-RT-10000/5	10000	5	u-OS	2942050000
PWEB-DESIGNER-PRO				2857650000
PWEB-ES-DESIGNER-2000_FREE				3037270000
Basic Training				2938790000
Customer Specific Training				2938800000
SLA Technical Support				2938730000



# Operate machines and systems via browser interfaces

## PROCON-WEB SCADA – the future-proof visualisation solution

Easily scalable and platform-independent HMI and SCADA solutions can be used flexibly and make relevant machine data available everywhere. They facilitate fault processing as well as data recording and management to support the control of complex processes.

PROCON-WEB SCADA as a Windows application for complex tasks simplifies the project planning of modern multi-touch-capable user interfaces for automation. The integrated web server enables the use of all HTML5-capable browsers without special plug-ins. The comprehensive portfolio of communication drivers facilitates the connection with all common control systems. Standardised open interfaces guarantee problem-free integration into any IT surroundings.

### Your special advantage:

- Easy creation of modern user interfaces without knowledge of web technologies
- Dynamic web interface with adaptive design and customisable control elements
- User and rights management including geographical rights assignment
- Ideal for control technology or complex digitalisation tasks
- Expanded scope of functions for more efficient data processing



For more information, visit our website:  
[www.weidmuller-gti-software.com](http://www.weidmuller-gti-software.com)



**Future-proof solution**

Intuitive user interfaces, the solutions are especially future-proof with the help of an adaptive UX design and the use of state-of-the-art web technologies.

**Efficient project planning**

The class-instance concept and automation objects with structure support accelerate project planning. Scripting and customisable control elements increase flexibility for special requirements.



**Simple scalability**

From simple HMI applications to complex SCADA applications, PROCON-WEB SCADA is scalable and flexible, and can be integrated into your IT environment through open standards and interfaces.



PROCON-WEB SCADA - Visualisation solutions for your Industrial IoT applications

Ordering data

Type	Number of process variables, max.	Number of devices	Platform for runtime system	Order No.
<b>SCADA runtime licences</b>				
PWEB-SCADA-RT-500/2	500	2	Windows	2857420000
PWEB-SCADA-RT-500/5	500	5	Windows	2857430000
PWEB-SCADA-RT-500/10	500	10	Windows	2857470000
PWEB-SCADA-RT-1000/2	1000	2	Windows	2857480000
PWEB-SCADA-RT-1000/5	1000	5	Windows	2857520000
PWEB-SCADA-RT-1000/10	1000	10	Windows	2997580000
PWEB-SCADA-RT-2000/2	2000	2	Windows	2857540000
PWEB-SCADA-RT-2000/5	2000	5	Windows	2857550000
PWEB-SCADA-RT-2000/10	2000	10	Windows	2857560000
PWEB-SCADA-RT-5000/2	5000	2	Windows	2857570000
PWEB-SCADA-RT-5000/5	5000	5	Windows	2857580000
PWEB-SCADA-RT-5000/10	5000	10	Windows	2857600000
PWEB-SCADA-RT-10000/2	10000	2	Windows	2857610000
PWEB-SCADA-RT-10000/5	10000	5	Windows	2857620000
PWEB-SCADA-RT-10000/10	10000	10	Windows	2857630000
PWEB-SCADA-RT-30000/2	30000	2	Windows	2862170000
PWEB-SCADA-RT-30000/5	30000	5	Windows	2862180000
PWEB-SCADA-RT-30000/10	30000	10	Windows	2862190000
PWEB-SCADA-RT-60000/2	60000	2	Windows	2862200000
PWEB-SCADA-RT-60000/5	60000	5	Windows	2862210000
PWEB-SCADA-RT-60000/10	60000	10	Windows	2862220000
PWEB-DESIGNER-PRO			Windows	2857650000
PWEB-ES-DESIGNER-2000_FREE			Windows	3037270000
Basic Training				2938790000
Customer Specific Training				2938800000
SLA Technical Support				2938730000

# Service and support

<b>Service and support</b>	Service connects - worldwide	V.2
	Engineering services and customised products	V.3
	Support Center	V.4
	Additional support services	V.5
	easyConnect - Your Industrial Service Platform	V.6
	Digital Engineering: Digital planning with Weidmüller product data, interfaces and software solutions	V.8
	Connectivity Consulting: A long-term increase in efficiency through partnership-based exchange	V.9
	Weidmüller Configurator: intuitive, uncomplicated & fast digital engineering	V.10
	Your digital ordering options at Weidmüller	V.12

## Our expertise for your requirements

### Service connects – worldwide



Automation technology functions are becoming more complex in a globally-oriented world facing ambitious targets in terms of energy efficiency and smart production. We are your equal partners for the best connections in Industrial Connectivity.

Our personal support answers all questions reliably and expertly. During planning, installation or operation our service and support offer is your best companion.

In short: Weidmüller's global service combines our expertise with your requirements.

V



Your way to our service  
[www.weidmueller.com/service](http://www.weidmueller.com/service)

# Engineering services and customised products

Automation engineering and connectivity consulting belongs to our services as well as assembly of engineered products. We also support the process from the idea to the product with our Weidmüller Configurator and the Configure-to-Order process.



## Consulting and engineering

The challenge for you is reducing costs and increasing efficiency. This requires intelligent, individual solutions. Whether it is modified products, pre-fitted mounting rails or complete small cabinets – our application centres provide a highly qualified custom-made engineering and production service.



## Connectivity Consulting

Increase your competitiveness - supported by our experts. Our drive is to optimise your competitiveness. That's why our team of experts supports you in significantly increasing your efficiency in electrical machine design and control cabinet construction. With proven products and services from the Weidmüller portfolio – and with the experience gained from over 300 projects worldwide.



## Klippon® Assembly Service – Assembled terminal rails and enclosures supplied ready for installation

The Klippon® Assembly Service supplies fully assembled terminal rails and enclosures that can be installed directly in the cabinet or on the machine. It therefore simplifies planning, accelerates production processes, reduces work steps and ensures the reliable delivery of individually assembled products.

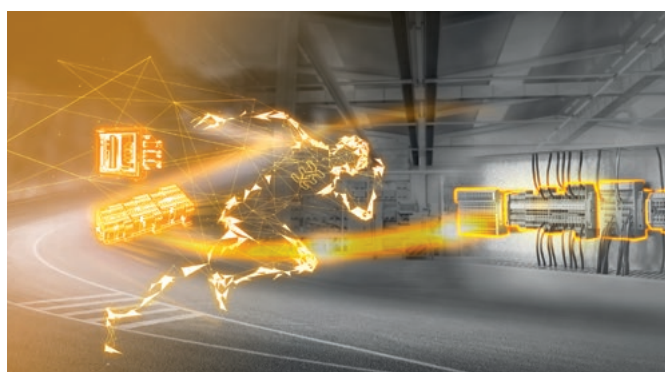

## Fast Delivery Service - Your ideas deserve a quick realisation

Obtain offers 24/7 and within minutes, including directly orderable article numbers with our Fast Delivery Service. The Weidmüller Configurator (WMC) for planning and configuration is key for consistent processes. Dispatch your orders in 5 days. Assemble individual terminal strips and enclosures from batch size 1!

## Expand the possibilities of our products

### Our Support Center - the answer is just a click away



Receive fast and intuitive support to get the most out of our products in your application. In our new Support Center you can search or navigate to the many application notes, product information, video tutorials or software downloads of our products. It is also possible to create a technical Service Request in the Support Center and check the current status at any time. Use our AI chatbot for u-mation and u-software products and get immediate answers to your questions at any time.

- **Support Center** – the answer is just a click away
- **Everything at a glance** – One central support hub, where all relevant information is available
- **Powerful search** – Provides filter functions for various types of information and products
- **Navigation through product hierarchy** – Navigation to specific products through our product hierarchy
- **More than 40,000 downloads** – Application notes, video tutorials, templates and examples, user documentation, engineering data, ...
- **Personal contact** – Direct access to your personal technical contact in your country
- **Quick help via Service Request** – Create a service request to get quick technical help and check the current status and the solution provided



Explore the world of our new Support Center  
[support.weidmueller.com](https://support.weidmueller.com)

## Additional support services

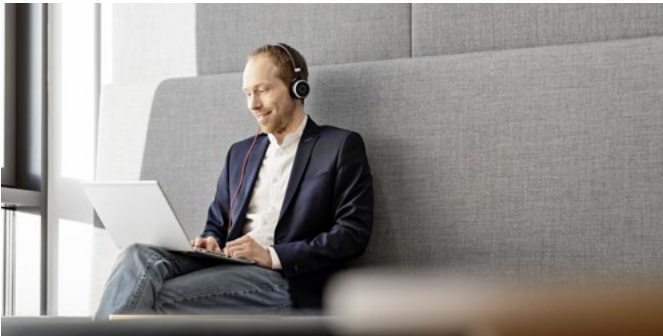

### Training and Webinars

Stay tuned in a world that is accelerating. In our entertaining interactive webinars, we offer you the opportunity to learn about new products and technology topics and to interact with our experts.

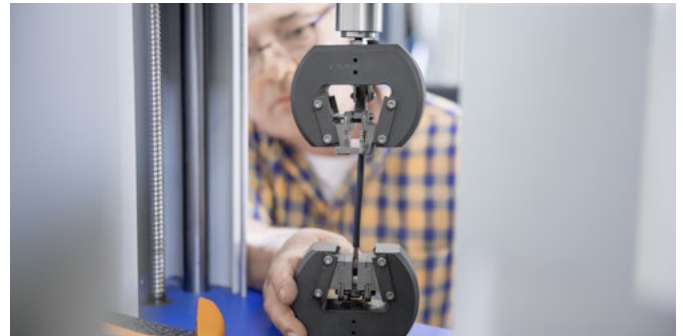

### Repairs and replacement parts

We offer repair and components for our Workplace Solutions as well as assistance for other Weidmüller products. Find out how our experts can help you with your repair request.



### Security advisory board

Our Product Security Incident Response Team (PSIRT) continuously informs you about possible security-related vulnerabilities of our products.

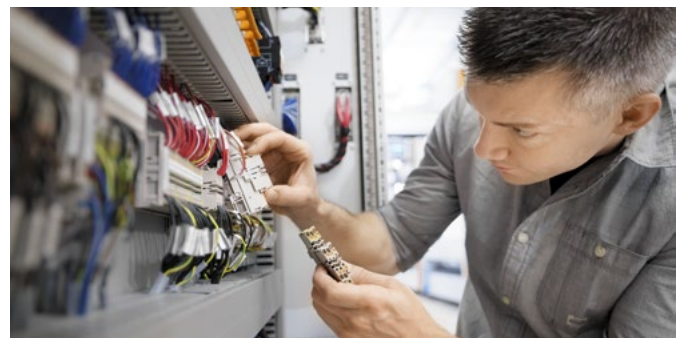

### Product change notifications

Technical modifications of our products always available online.

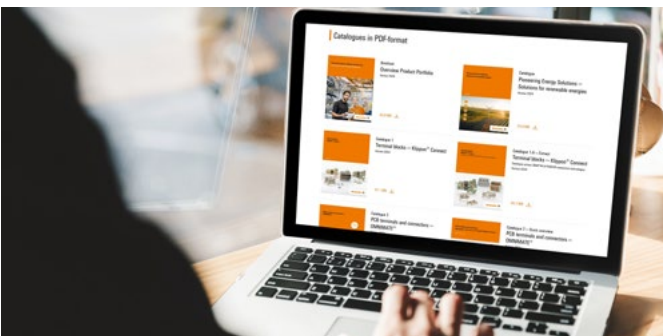

### Technical product catalogues

Technical data for our entire program in Industrial Connectivity for download in PDF-format.

# Your ticket to the world of digital service

## easyConnect – Your Industrial Service Platform



Our cloud-based platform is your ticket to the world of digital services from Weidmüller, and the intuitive and future-proof tool for your way to the Industrial IoT. Realise your use cases easily, consistently and without any relevant prior knowledge, thanks to the perfect interaction of platform, devices and diverse software services.

As an open, modular and perfectly integrable system, the platform is your enabler for a wide range of use cases. Increase your efficiency and unleash your full innovation potential with easyConnect.

V



Interested in using easyConnect?  
Learn how to get started with easyConnect step-by-step.  
[www.weidmueller.com/easyconnect](http://www.weidmueller.com/easyconnect)

## Why should you use easyConnect?

- You want to enter your digital transformation step-by-step?
- You want to make the step into Industrial IOT, but have no or little IT expertise?
- You want to use your digital data for smart & scalable services?
- You want to offer digital services (such as customised dashboard) to your customers?
- You want to improve your service offering and efficiency, e.g. through remote access?
- You feel Weidmüller's digital services are interesting, but you have „your cloud“ already?



Weidmüller comes up with the solution: easyConnect, the new digitalisation platform. It bundles Weidmüller's digital services at one place in the cloud and connects them with various Weidmüller devices.

With easyConnect you start digitalising your application step-by-step without ballast in a secure way.

## The following services are initially available on easyConnect:

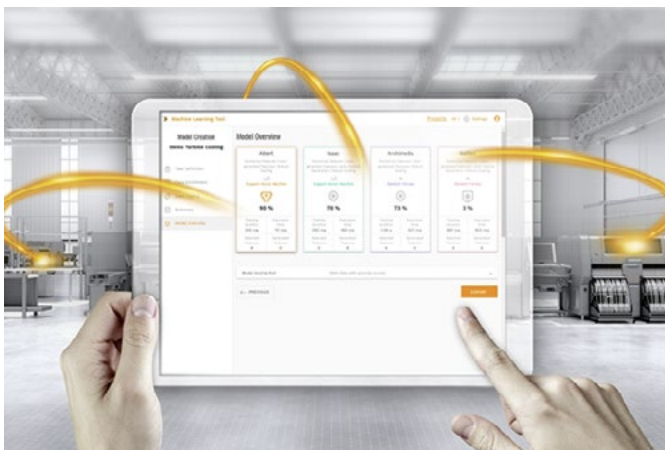

### Device management

Adding and managing cloud-connected devices is typically the first step in any Industrial IoT use case.

### Asset management

The asset management service is a modelling tool that allows users to model their assets and processes and link them to relevant time series data.

### Remote access (u-link)

u-link guarantees a quick and secure access to machines and plants while also allowing for efficient management.

### Data visualisation

easyConnect data visualisation services enable users to view, monitor and display live and historical data.

### AutoML

With Weidmüller Industrial AutoML, you can optimize operations, increase product quality and develop new business models by benefiting from advanced analytics.

# Digital Engineering

## Digital planning with Weidmüller product data, interfaces and software solutions

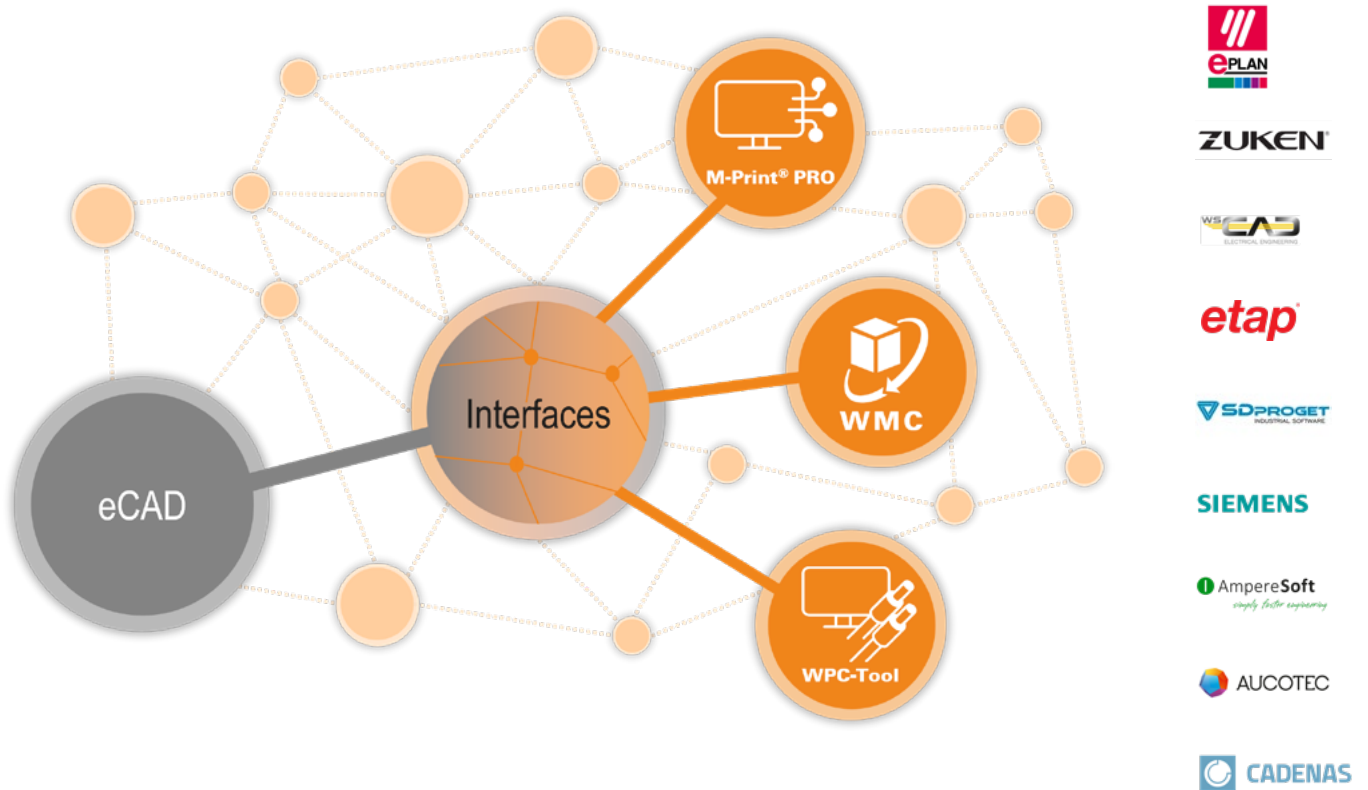

You want to be optimally supported in all steps of the electrical design process, from planning to production? Weidmüller offers you support as best as possible!

### Your advantages:

- **Processes are digitized, time is saved and sources of errors are eliminated** – With Weidmüller software solutions for terminal strip and housing configuration (WMC), component marking (M-Print® PRO) and cable assembly (WPC-Tool), you are perfectly prepared for all project phases in electrical design and control cabinet construction.
- **Potential sources of error are eliminated and your productivity is increased** – High-performance interfaces enable a complete data consistency from the planning to the commissioning process.
- **A simple, safe and fast design process** – Weidmüller provides digital product data for a variety of engineering systems. The data is always compliant with the latest system provider standard.



Find out more about digital engineering  
[www.weidmueller.com/digital\\_engineering](http://www.weidmueller.com/digital_engineering)

# Connectivity Consulting

## Counteracting the shortage of skilled workers with Connectivity Consulting



Are you looking for innovative, sustainable and value-adding solutions for your individual requirements? Weidmüller offers you support with experienced experts for products, solutions and services in the industrial environment of energy, signals and data!

### Your advantages:

- **Increasing efficiency and quality in cabinet building** – Weidmüller offers you customized solutions to make your cabinet building fit for purpose. From design optimization and process automation to digital planning and commissioning. Every single work step offers opportunities for optimization.
- **Benefit from the practical experience of the experts** – Weidmüller's connectivity consulting experts have acquired practical specialist knowledge in many international projects.
- **Support in the implementation process** – From analysis to implementation: Our experts support you with all measures.



Find out more about Connectivity Consulting  
[www.weidmueller.com/connectivity-consulting](http://www.weidmueller.com/connectivity-consulting)

# Boost Your Efficiency from Engineering to Production

## Weidmüller Configurator: intuitive, uncomplicated & fast digital engineering

Digital engineering can be so easy – with the Weidmüller Configurator!

Discover the Weidmüller Configurator (WMC) – your free software solution that guides you through the entire value chain, all the way to production.

With access to nearly 14,000 digital products, the WMC provides an extensive range for configuring terminal strips, processed empty enclosures, and ready-to-connect terminal boxes. This includes over 10,500 products for terminal strip configurations, approximately 2,200 products for terminal box configurations, and around 1,200 products for configuring our heavy-duty connectors.

### Your Benefits with the Well-Known WMC:

- **Seamless Engineering** – Import your circuit diagrams and terminal strips effortlessly with a single click directly from your engineering system into the WMC. Our interfaces enable continuous data flows, saving you valuable time, minimizing errors, and ensuring smooth project execution.
- **Optimized Production** – The WMC supports you on the shop floor, helping you assemble the required configurations yourself. Especially in times of skilled labor shortages, the WMC makes your production more efficient. With its user-friendly interface, 3D and touch functions, it eases the workload for your employees.



All information about the software can be found here:  
[www.weidmueller.com/wmc](http://www.weidmueller.com/wmc)

# New Online Configurator – Experience the Future of Digital Engineering

Configure. Share. Access anywhere.



**Online & Ready to Go:** No installation required – use the Online Configurator directly in your browser. Access it flexibly from any device, whether PC or tablet, in the office or on the go. Your production will have a read-only view mode to ensure the security and consistency of your configurations.

**Intelligent Optimization with a single Click:** Reduce the width of your terminal strip with just one click – no product knowledge needed. Easily switch connection technologies, for example, from screw to PUSH IN or even to our innovative SNAP IN technology. Or take it a step further and transform your configured rail directly for labeling with the Klippon® Automated RailLaser.

**Easy Transition – Seamlessly Integrated:** Thanks to the integrated cloud upload function, you can transfer your existing terminal strip configurations from the WMC with just one click.

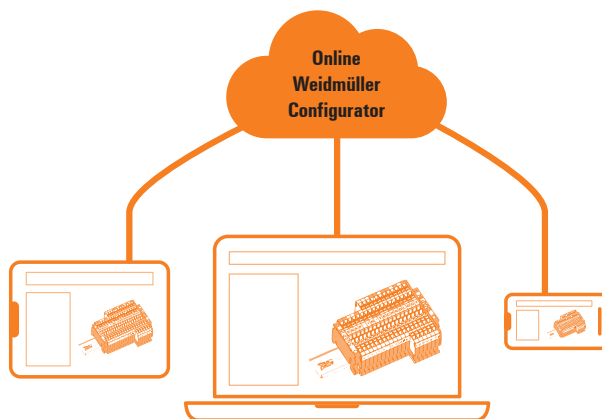
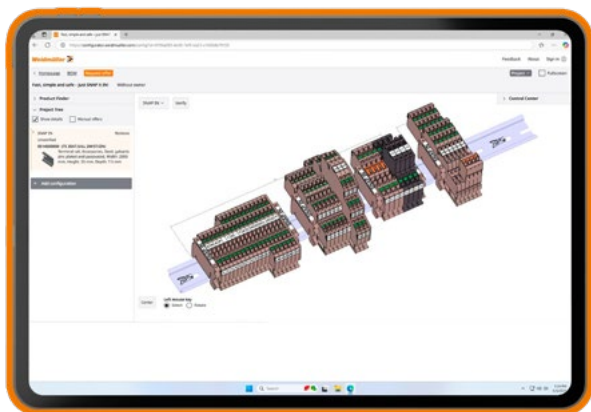

Start online now!  
Configure anywhere, anytime and online.  
[configurator.weidmueller.com](http://configurator.weidmueller.com)



### Fast Delivery with Both Configurators:

Whether you use the WMC or the Online Configurator – individually configured mounting rails (and enclosures in the WMC) can be directly transferred to the “Fast Delivery Service.” You will receive ready-to-install solutions in the shortest possible time. This combines maximum customization with minimal delivery time, allowing you to benefit from fast and reliable delivery.

# Digital ordering options

## Your digital ordering options at Weidmüller

Find and easily select the products you need, with convenient ordering: as your Partner in Industrial Connectivity, we know what counts in purchasing. That is why we offer you a variety of options for ordering products from us and optimising your purchasing processes to meet your individual requirements and your workflow. The choice is yours.

### Order via the Weidmüller eShop

Our eShop offers you access to the complete Weidmüller product range around the clock – directly from a PC, tablet, or smartphone. The intuitive user guidance supports you as you select from over 50,000 products. Technical data, prices, and availabilities are available at any time. The shopping basket with check out function lets you place an order in seconds. Convenient additional functions like CSV upload, order history, reports, or custom order templates make your ordering processes even more efficient.

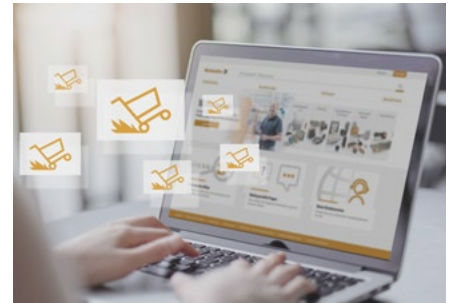

### Order via the OCI interface

The Open Catalogue Interface (OCI) facilitates the exchange of data between your enterprise resource planning system and our eShop. This means that our eShop is integrated into your system via an OCI interface, so you have access to our complete product catalogue from your enterprise resource planning system. You can filter and select products, place them in your shopping basket and place direct orders without changing your software application. The open OCI standard is supported worldwide from a variety of software providers.

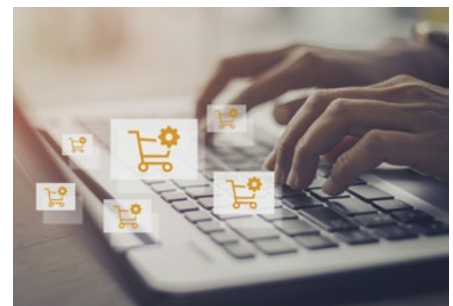

### Order via the EDI interface

Our Electronic Data Interchange (EDI) also offers you the option of ordering our products directly from your enterprise resource planning system. All order data is transmitted automatically to our system and processed immediately. Orders, order confirmations, invoices, and delivery notices are transmitted lightning fast. This helps you make your purchasing processes even more efficient.

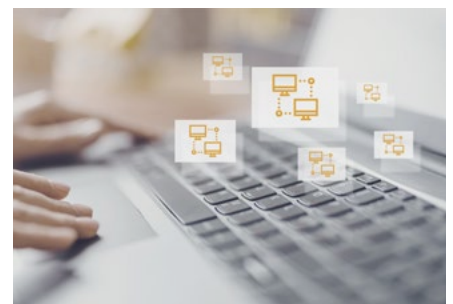

We will be glad to advise you on which solutions are suitable for you and how implementation is possible.  
Get in touch with us  
[www.weidmueller.com/digital-order](http://www.weidmueller.com/digital-order)

# Index

<b>Index</b>	Index Type	X.2
	Index Order No.	X.6



Type	Order No.	Page
<b>A</b>		
A2C 1.5	1552790000	D.20
A2C 150/185	2728700000	E.16
A2C 150/185 BL	2728710000	E.16
A2C 2.5	1521850000	C.34
A2C 2.5	1521850000	C.20
A2C 35	2551510000	C.36
A2C 35	2551510000	E.16
A2C 35 BL	2552090000	C.34
A2C 35 BL	2552090000	E.16
A2C 35 PE	2551520000	C.34
A2C 35 PE	2551520000	E.16
A2C 4	2051180000	C.34
A2C 50/70	2663250000	C.34
A2C 50/70	2663250000	E.16
A2C 50/70 BL	2663260000	C.34
A2C 50/70 BL	2663260000	E.16
A2C 50/70 PE	2663280000	C.34
A2C 50/70 PE	2663280000	E.16
A2C 95/120	2694060000	E.16
A2C 95/120 BL	2694070000	E.16
A2C 95/120 PE	2694090000	E.16
A2T 1.5	2469370000	C.34
A2T 2.5	1547610000	C.34
A2T 2.5 3C	2531290000	C.34
A2T 2.5 DT/DT	2744110000	C.34
A3C 1.5	1552740000	D.20
A3C 10	2490520000	E.16
A3C 16	2494090000	E.16
A3C 2.5	1521740000	C.34
A3C 2.5	1521740000	D.20
A3C 4	2051240000	C.34
A3C 4 PE	2051410000	C.34
A4C 1.5	1552690000	D.20
A4C 2.5	1521690000	C.34
A4C 2.5	1521690000	E.16
A4C 2.5 PE	1521540000	C.34
A4C 4	2051500000	C.34
A4C 4	2051500000	E.16
A4C 6	2881450000	E.16
A4C 35 2X6	2583090000	E.16
A4C 35 2X6 BL	2583170000	E.16
A4C 35 2X6 GN-YL	2583180000	E.16
A4C 50-185 2X10	2663420000	E.16
A4C 50-185 2X10 BL	2663430000	E.16
A4C 50-185 2X10 GN-YL	2663440000	E.16
ACT20C-8AI-MRTU-DC-S	8000110028	D.25
ACT20C-CMT-10-AD-RC-S	1510240000	E.14
ACT20C-CMT-60-AD-RC-S	1510420000	E.14
ACT20C-GTW-100-MTCP-S	1510370000	E.14
ACT20C-LBT-10	1510340000	E.14
ACT20P-CI-CD-P-P	2514620000	D.25
ACT20P-CI-VD-P	2489740000	D.25
ACT20P-CI1-CD-OLP-P	7760054353	D.25
ACT20P-CMT-10-AD-RC-P	1510330000	E.14
ACT20P-CMT-30-AD-RC-P	1510320000	E.14
ACT20P-CMT-60-AD-RC-P	1510290000	E.25
ACT20P-CMT-60-AD-RC-P	1510290000	D.15
ACT20P-CMT-60-AD-RC-P	1510290000	E.14
ACT20P-PRO-FI-AD-QD-P	2447950000	D.25
ACT20P-PRO-RTCI-AD-DO-S	2448100000	D.25
ACT20P-TCI-2AD-P	7760054188	D.25
ACT20P-UI-2RCO-DC-S	7940045760	D.25
ACT20P-VIM-AD-P	7760054360	E.15
ACT20P-VIM-AD-P	7760054360	E.14
ACT20P-VIMR-1PH-H-P	7760054359	D.25
ACT20X-2AI-2SAO-P	2456150000	D.25
ACT20X-2HD1-2SDO-P	2456100000	D.25
ACT20X-2HD1-2SDO-RNO-P	2456080000	D.25
ACT20X-2HT1-2SAO-P	2456190000	D.25
ACT20X-2SAI-2HAD-P	2456170000	D.25
ACT20X-2SDI-2HDO-P	2456130000	D.25
ACT20X-HUI-SAO-P	2456200000	D.25
ADT 2.5 2C	1989800000	C.34
ADT 2.5 4C	1989800000	C.34
ADT 4 2C	2429850000	C.34
AFS 4 2C 100-250V BK	2434390000	C.34
AFS 4 2C BK	2429860000	C.34
AL2C 2.5	2847200000	D.20
ALO 16	2502280000	E.17
ALO 6	1991780000	E.17
AMG AM CO	2082770000	C.45
AMG AM CO	2082770000	D.29
AMG CM	2081900000	C.45
AMG CM	2081900000	D.29
AMG CM EX	2083360000	D.29
AMG DIS	2123050000	C.45
AMG DIS	2123050000	D.29
AMG DIS	2123050000	E.15
AMG DIS EX	2495100000	D.29
AMG ELM-10F	2080650000	A.37
AMG ELM-12	2080410000	A.37
AMG ELM-18	2859800000	C.45
AMG ELM-18	2859800000	D.29
AMG ELM-18 EX	2838520000	D.29
AMG ELM-1F	2080420000	A.37
AMG ELM-2F	2080480000	A.37

Type	Order No.	Page
<b>B</b>		
AMG ELM-4F	2080490000	A.37
AMG ELM-6	2080360000	A.37
AMG ELM-6F	2080500000	A.37
AMG ELM-8F	2080600000	A.37
AMG EP KIT	2500760000	A.37
AMG FIM-O	2081870000	A.37
AMG FIM-C	2081880000	A.37
AMG MD	2122930000	A.37
AMG MD	2122930000	C.45
AMG MD	2122930000	D.29
AMG MD	2122930000	E.15
AMG OD	2122910000	A.37
AMG OD	2122910000	E.15
AMG PD	2122920000	A.37
AMG PD	2122920000	C.45
AMG PD	2122920000	D.29
AMG PD	2122920000	E.15
AMG PP	2123000000	A.37
AMG XMD	2122940000	A.37
APG 80	2853270000	C.24
APG 80	2853270000	C.25
APG 80	2853270000	C.26
APG 80	2853270000	C.28
ATTB 6	2710070000	D.20
ATTB 6 PE	2710080000	D.20
AWPD 35 4X10 BL	2860570000	E.17
AWPD 35 4X10 FE	2924990000	E.17
AWPD 35 4X6/6X2.5	2728620000	E.17
AWPD 35 4X6/6X2.5 BL	2860560000	E.17
AWPD 35 4X6/6X2.5 FC	2924980000	E.17
<b>B</b>		
Basic Training	2938790000	F.7
Basic Training	2938790000	F.12
Basic Training	2938790000	F.16
BG ARGH HQP ALU PT6 CS	1532210000	E.19
BLF 3.50/02/180 SN OR BX	2458950000	C.37
BLF 3.50/03/180 SN OR BX	2459060000	C.37
BLF 3.50/04/180 SN OR BX	2459070000	C.37
BLF 3.50/05/180 SN OR BX	2459080000	C.37
BLF 3.50/06/180 SN OR BX	2459090000	C.37
BLF 3.50/07/180 SN OR BX	2459100000	C.37
BLF 3.50/08/180 SN OR BX	2459110000	C.37
BUZ 10.16IT/02/180MF2 AG BK BX	1156600000	E.24
BVDF 7.62HP/02/180MF2 SN BK BX	2720550000	E.24
BVZ 7.62IT/02/180MF2 SN BK BX	1156710000	E.24
<b>C</b>		
CABTITE BSE LRG GY	2584520000	D.33
CABTITE BSE SML GY	2583500000	D.33
CABTITE FRFT 10/6 SET	2891500000	D.33
CABTITE FRFT 16/8 SET	2891530000	D.33
CABTITE FRFT 24/10 SET	2891560000	D.33
CABTITE FRFT 4-1 SET	2891470000	D.33
CABTITE SE 10-11 SML GY	2584610000	D.33
CABTITE SE 2/5-6 SML GY	2584890000	D.33
CABTITE SE 34-35 LRG GY	2595300000	D.33
CABTITE SE 5-6 SML GY	2583450000	D.33
CABTITE SE 6-7 SML GY	2583460000	D.33
CONDITION MONITORING BOX IO 100EX	8000140773	D.19
CP DC UPS 24V 20A/10A	1370050010	C.45
CP DC UPS 24V 20A/10A	1370050010	D.29
CR20024	3052430000	E.21
CR20024T	3052510000	E.21
CRM40024	3052940000	E.21
CRM40024T	3053010000	E.21
CSI P 2CD	3052570000	E.21
CSI S 2CO	3052590000	E.21
CSI P 4CO	3053140000	E.21
CSM S 4CO	3053160000	E.21
Customer Specific Training	2938800000	F.12
Customer Specific Training	2938800000	F.16
CVM IO 160 HDC	8000140778	D.18
CVM PLC 100 CABTITE PSU 24V	8000142794	D.18
CXI CLIP P	3052710000	E.21
CXM CLIP P	3053240000	E.21
<b>D</b>		
DRH276024LT	1220150000	D.26
DRH424024	7760056322	D.26
DRH424024LTD	7760056340	D.26
DRIKITP 24VDC 2CD LD/PB	2576190000	A.33
DRM570024LT	7760056097	D.26
DRM570220	7760056082	D.26
DRMKITP 24VDC 4CO LD/PB	2576140000	A.33
DURA ECO LA-BAT 24V 12AH	2789920000	C.45
DURA ECO LA-BAT 24V 12AH	2789920000	D.29
DURA ECO LA-BAT 24V 17AH	2789930000	C.45
DURA ECO LA-BAT 24V 17AH	2789930000	D.29
DURA ECO LA-BAT 24V 7AH	2789910000	C.45
DURA ECO LA-BAT 24V 7AH	2789910000	D.29
<b>E</b>		
EMI22-RTU-2P	7760051003	D.37
EM220-RTU-4DI2DO-6W	7760051006	D.37

Type	Order No.	Page
<b>F</b>		
ENERGY ANALYSER 750-24	2534160000	D.37
ENERGY LOGGER D550	2425520000	D.37
ENERGY METER 750-230	2540910000	D.37
EPG 45	1500830000	C.16
EPG 45	1500830000	C.18
EPG 45	1500830000	C.20
EPG 45	1500830000	C.21
ES APG 80 DIN 70	1502890000	C.24
ES APG 80 DIN 70	1502890000	C.25
ES APG 80 DIN 70	1502890000	C.26
ES APG 80 DIN 70	1502890000	C.28
ES EPG 45 DIN 25	1501340000	C.16
ES EPG 45 DIN 25	1501340000	C.18
ES EPG 45 DIN 35	1501350000	C.20
ES EPG 45 DIN 35	1501350000	C.21
<b>F</b>		
FC10 TN/26A S1 B BX	2827090000*	C.37
FFH9 S1/26V F1 B RL	2747370000	C.37
FFH9 S1/50V F1 B RL	2747400000	C.37
FFP D1/50H S1 B TY	2747580000	C.37
FMH3 S1/26V F1 B RL	2747100000	C.37
FMH3 S1/50V F1 B RL	2747130000	C.37
FRS TWC M30 EC 10	2881700000	A.15
FRS TWC M30 EC 10	2881700000	A.17
FRS TWC M30 MC 25	2861190000	A.15
FRS TWC M30 MC 25	2861190000	A.16
FRS TWC M30 SC 10	2881690000	A.15
FRS TWC M30 SC 10	2881690000	A.16
FSKIT 24VDC 2NO2NC FG LD AGSNO AU	2759080000	D.27
FSKIT 24VDC 3NO1NC FG LD AGSNO AU	2759070000	D.27
FSKIT 24VDC 3NO1NC FG LD AGSNO AU	2759100000	D.27
FSKIT 24VDC 4NO2NC FG LD AGSNO AU	2759090000	D.27
FSKIT 24VDC 5NO1NC FG LD AGSNO AU	2860020000	D.27
FUSE 10X38 1A 1000 VDC GVP	2783160000	E.23
FUSE WSFL 10X85 15A 1K5V GVP	4000002597	E.23
FUSE WSFL 2X258 30A 1K5V GVP	2873880000	E.23
FUSEHOLDER WSFH 10X38 1KV	2827940000	E.23
FUSEHOLDER WSFH 10X85 1K5V	4000002613	E.23
FUSEHOLDER WSFH 22X58 1K5V 80A	4000003740	E.23
<b>H</b>		
HDC 04A ALU	1497600000	C.39
HDC 04A ALU	1497600000	C.39
HDC 04A AWLU	1497700000*	D.24
HDC 04A AWLU	1497700000	D.24
HDC 04A TOLU 1M20G	1788820000	C.39
HDC 04A TOLU 1M20G	1788820000	D.24
HDC 06B ALU EXI	3001300000	D.22
HDC 06B TOLU 1M20G EXI	3001360000	D.22
HDC 06B TSLU 1M20G EXI	3001350000	D.22
HDC 10B ABU EXI	3001310000	D.22
HDC 10B T0BU 1M25G EXI	3001390000	D.22
HDC 10B T8BU 1M25G EXI	3001370000	D.22
HDC 16B ABU EXI	3001320000	D.22
HDC 16B T0BU 1M25G EXI	3001440000	D.22
HDC 16B T8BU 1M25G EXI	3001400000	D.22
HDC 24B ABU EXI	3001330000	D.22
HDC 24B ADLU	1214300000	C.39
HDC 24B ADLU	1214300000	D.23
HDC 24B ADLU	1214300000	D.24
HDC 24B HP550 MPL2 TYP1	1103710000*	C.41
HDC 24B HP550 MPL2 TYP1	1103710000	D.23
HDC 24B HP550 MPL2 TYP2	1103770000*	C.41
HDC 24B HP550 MPL2 TYP2	1103770000	D.23
HDC 24B HP550 MPL3 TYP1	1103720000	E.18
HDC 24B HP550 MPL3 TYP2	1103780000	E.18
HDC 24B T0BU 1M25G EXI	3001520000	D.22
HDC 24B T8BU 1M25G EXI	3001460000	D.22
HDC 24B TSLU 1M32G	1787790000	

Type	Order No.	Page
IE-SW-AL12M-8GT-4GESFP	2682340000	D.34
IE-SW-AL14M-12GT-2GESFP	2682360000	A.49
IE-SW-AL16M-16TX	2682310000	A.49
IE-SW-AL18M-16TX-2GC	2682330000	A.49
IE-SW-AL24M-16GT-8GESFP	2682370000	A.49
IE-SW-AL24M-24TX	2682320000	A.49
IE-SW-BLB-10-8GT-2GESFP	2908190000	D.34
IE-SW-EL05-5TX	2682130000	C.46
IE-SW-EL08-8POE	2682380000	C.46
IE-SW-EL08-8POE	2682380000	C.46
IE-SW-EL10-8GT-2GESFP	2682240000	D.34
IE-SW-ELB-05-5TX	2828540000	D.34
IE-SW-SL20M-8GT-12GESFP-HV	2778970000	C.46
IE-SW-SL26M-24TX-2GC-LV	2779000000	D.34
IE-SW-SL28M-HV	2779010000	C.46
IE-TD-RJ45-C	8946920000	C.46
IE-TD-RJ45-C	8946920000	C.46
IE-WLT-BLAP-CLEU	2536650000	A.49
IE-WLT-BLAP-CLEU	2536650000	C.46
IE-WLT-BLAP-CLEU	2536650000	D.34
IE-WLT-VL-AP-BR-CLEU	2536690000	A.49
Inbetriebnahme [Stunde]	2938840000	F.7
Installation Standard	2938810000	F.7
IOT-GW30	2682620000	D.35
IOT-GW30-4G-EU	2682630000	D.35

## K

KTb MH 403015 S4E0	1194900000	D.32
KTb MH 403015 S4E1	1194910000	D.32
KTb MH 403015 S4E2	1194920000	D.32
KTb MH 403015 S4E3	1194930000	D.32
KTb MH 403015 S4E4	1194940000	D.32
KTb MH 403020 S4E0	1194950000	D.32
KTb MH 403020 S4E1	1194960000	D.32
KTb MH 403020 S4E2	1194970000	D.32
KTb MH 403020 S4E3	1194980000	D.32
KTb MH 403020 S4E4	1194990000	D.32
KTb MH 453815 S4E0	1195000000	D.32
KTb MH 453815 S4E1	1195010000	D.32
KTb MH 453815 S4E2	1195020000	D.32
KTb MH 453815 S4E3	1195030000	D.32
KTb MH 453815 S4E4	1195040000	D.32
KTb MH 453820 S4E0	1195050000	D.32
KTb MH 453820 S4E1	1195060000	D.32
KTb MH 453820 S4E2	1195070000	D.32
KTb MH 453820 S4E3	1195080000	D.32
KTb MH 453820 S4E4	1195090000	D.32
KTb QL 403015 S4E0	1200220000	D.32
KTb QL 403015 S4E1	1200230000	D.32
KTb QL 403015 S4E2	1200240000	D.32
KTb QL 403015 S4E3	1200250000	D.32
KTb QL 403015 S4E4	1200260000	D.32
KTb QL 403020 S4E0	1200270000	D.32
KTb QL 403020 S4E1	1200280000	D.32
KTb QL 403020 S4E2	1200290000	D.32
KTb QL 403020 S4E3	1200310000	D.32
KTb QL 403020 S4E4	1200320000	D.32
KTb QL 453815 S4E0	1200330000	D.32
KTb QL 453815 S4E1	1200340000	D.32
KTb QL 453815 S4E2	1200350000	D.32
KTb QL 453815 S4E3	1200360000	D.32
KTb QL 453815 S4E4	1200370000	D.32
KTb QL 453820 S4E0	1200380000	D.32
KTb QL 453820 S4E1	1200390000	D.32
KTb QL 453820 S4E2	1200410000	D.32
KTb QL 453820 S4E3	1200420000	D.32
KTb QL 453820 S4E4	1200430000	D.32

## L

LLF 7.50/01/90 5.0SN BK BX	2471520000	E.24
LLFS 7.50/01/180 5.0SN BK BX	2491110000	E.24
LLFS 7.50/01/90 5.0SN BK BX	2473420000	E.24
LSF-SMT 3.50/02/90 3.5SN BK TU	1824420000	C.37
LSF-SMT 3.50/03/90 3.5SN BK TU	1824430000	C.37
LSF-SMT 3.50/04/90 3.5SN BK TU	1824440000	C.37
LSF-SMT 3.50/05/90 3.5SN BK TU	1824450000	C.37
LSF-SMT 3.50/06/90 3.5SN BK TU	1824460000	C.37
LSF-SMT 3.50/07/90 3.5SN BK TU	1824470000	C.37
LSF-SMT 3.50/08/90 3.5SN BK TU	1824480000	C.37
LUF 10.00/01/90 5.0SN BK BX	1988590000	C.37
LUF 10.00/02/90 5.0SN BK BX	1988600000	C.37
LUF 10.00/03/90 5.0SN BK BX	1988610000	C.37
LUF 10.00/04/90 5.0SN BK BX	1988620000	C.37
LUF 10.00/05/90 5.0SN BK BX	1988630000	C.37
LUF 15.00/02/90V 5.0SN BK BX	2492000000	E.24
LUF 15.00/01/180 5.0SN BK BX	2491810000	E.24
LUF 15.00/01/90 5.0SN BK BX	2500560000	E.24
LUF 15.00/02/180V 5.0SN BK BX	2491820000	E.24
LUF 15.00/02/90V 5.0SN BK BX	2499440000	E.24

## M

MCZ R 48...110VDC 1CU AU TRAK	8790500000	A.33
MCZ R 48...110VDC 1CU TRAK	8713910000	A.33
MHS 5/02 H T3 B T	2741400000	C.36
MHS 5/03 H T3 B T	2741420000	C.36
MHS 5/04 H T3 B T	2741430000	C.36

Type	Order No.	Page
MHS 5/05 H T3 B T	2741440000	C.36
MHS 5/06 H T3 B T	2741450000	C.36
MHS 5/07 H T3 B T	2741460000	C.36
MHS 5/08 H T3 B T	2741470000	C.36
MPS 5/02 S TN B B	2741560000	C.36
MPS 5/03 S TN B B	2741570000	C.36
MPS 5/04 S TN B B	2741580000	C.36
MPS 5/05 S TN B B	2741590000	C.36
MPS 5/06 S TN B B	2741600000	C.36
MPS 5/07 S TN B B	2741610000	C.36
MPS 5/08 S TN B B	2741620000	C.36

## P

P-COM CON 100	3053940000	F.9
P-COM CON 1000	3053970000	F.9
P-COM CON 10000	3054000000	F.9
P-COM CON 250	3053950000	F.9
P-COM CON 2500	3053980000	F.9
P-COM CON 50	3053930000	F.9
P-COM CON 500	3053960000	F.9
P-COM CON 5000	3053990000	F.9
P-COM DRV ALLENBRADLEY	3053920000	F.9
P-COM DRV CODESYS	3053910000	F.9
P-COM RUN	3053900000	F.9
PB-CON 160 S/02/90RFSF AG BK BX	2594720000	E.24
PB-FEED 160 100/02RF AG BK BX	2595180000	E.24
PB-LINK 160 50/02RF AG BK BX	2595540000	E.24
PC RC F	2833850000	A.25
PC RC M	2820090000	A.25
PRO BAS 120W 12V 10A	2838450000	A.37
PRO BAS 120W 24V 5A	2838440000	A.37
PRO BAS 240W 24V 10A	2838460000	A.37
PRO BAS 240W 48V 5A	2838470000	A.37
PRO BAS 30W 12V 2.6A	2838510000	A.37
PRO BAS 30W 24V 1.3A	2838500000	A.37
PRO BAS 30W 5V 6A	2838400000	A.37
PRO BAS 480W 24V 20A	2838480000	A.37
PRO BAS 480W 48V 10A	2838490000	A.37
PRO BAS 60W 12V 5A	2838420000	A.37
PRO BAS 60W 24V 2.5A	2838410000	A.37
PRO BAS 90W 24V 3.8A	2838430000	A.37
PRO COM CAN OPEN	2467320000	A.37
PRO COM CAN OPEN	2467320000	C.45
PRO COM CAN OPEN	2467320000	D.28
PRO COM DISPLAY 7S	2466960000	E.15
PRO COM DISPLAY 7S	2466960000	E.15
PRO COM DISPLAY 7S	2466960000	D.28
PRO COM IO-LINK	2587360000	A.45
PRO COM IO-LINK	2587360000	C.45
PRO COM IO-LINK	2587360000	D.28
PRO COM IO-LINK	2587360000	E.15
PRO MAX 120W 24V 5A	1478110000	A.37
PRO MAX 240W 24V 10A	1478130000	A.37
PRO MAX 240W 24V 10A	1478130000	C.44
PRO MAX 240W 24V 10A	1478130000	D.29
PRO MAX 240W 48V 5A	1478240000	C.44
PRO MAX 480W 24V 20A	1478140000	A.37
PRO MAX 480W 24V 20A	1478140000	C.44
PRO MAX 480W 48V 10A	1478250000	C.44
PRO MAX 70W 5V 14A	1478210000	C.44
PRO MAX 70W 5V 14A	1478210000	D.29
PRO MAX 72W 24V 3A	1478100000	C.44
PRO MAX 72W 24V 3A	1478100000	D.29
PRO MAX 960W 24V 40A	1478150000	C.44
PRO MAX 960W 48V 20A	1478270000	C.44
PRO MAX 960W 48V 20A	1478270000	D.29
PRO MAX3 120W 24V 5A	1478170000	C.44
PRO MAX3 120W 24V 5A	1478170000	D.29
PRO MAX3 240W 24V 10A	1478180000	A.37
PRO MAX3 240W 24V 10A	1478180000	C.44
PRO MAX3 240W 24V 10A	1478180000	D.29
PRO MAX3 240W 24V 10A	1478180000	E.24
PRO MAX3 480W 24V 20A	1478190000	A.37
PRO MAX3 480W 24V 20A	1478190000	C.44
PRO MAX3 480W 24V 20A	1478190000	D.29
PRO MAX3 960W 24V 40A	1478200000	C.44
PRO MAX3 960W 24V 40A	1478200000	D.29
PRO TOP1 120W 24V 5A	2466870000	A.37
PRO TOP1 120W 24V 5A	2466870000	C.44
PRO TOP1 120W 24V 5A	2466870000	D.28
PRO TOP1 120W 24V 5A EX	2466980000	D.28
PRO TOP1 240W 24V 10A	2466880000	A.37
PRO TOP1 240W 24V 10A	2466880000	C.44
PRO TOP1 240W 24V 10A	2466880000	D.28
PRO TOP1 240W 24V 10A	2466880000	E.24
PRO TOP1 240W 24V 10A EX	2466990000	D.28
PRO TOP1 480W 24V 20A	2466890000	A.37
PRO TOP1 480W 24V 20A	2466890000	C.44
PRO TOP1 480W 24V 20A	2466890000	D.28
PRO TOP1 480W 24V 20A EX	2467000000	D.28
PRO TOP1 480W 48V 10A	2467030000	C.44
PRO TOP1 960W 24V 40A	2466900000	C.44
PRO TOP1 960W 24V 40A	2466900000	D.28
PRO TOP1 960W 24V 40A EX	2467010000	D.28
PRO TOP1 960W 48V 20A	2466920000	C.44
PRO TOP3 120W 24V 5A	2467060000	A.37
PRO TOP3 120W 24V 5A CO	2467070000	C.44
PRO TOP3 120W 24V 5A CO	2467070000	D.28
PRO TOP3 240W 24V 10A	2467080000	A.37

Type	Order No.	Page
PRO TOP3 240W 24V 10A CO	2467090000	C.44
PRO TOP3 240W 24V 10A CO	2467090000	D.28
PRO TOP3 480W 24V 20A	2467100000	A.37
PRO TOP3 480W 24V 20A CO	2467110000	C.44
PRO TOP3 480W 24V 20A CO	2467110000	D.28
PRO TOP3 480W 48V 10A	2467150000	C.44
PRO TOP3 960W 24V 40A CO	2467130000	C.44
PRO TOP3 960W 24V 40A CO	2467130000	D.28
PRO TOP3 960W 48V 20A	2467170000	C.44
PRO TOPDC 24V/24V 10A	2627640000*	C.45
PRO TOPDC 24V/24V 10A	2627640000	D.28
PRO TOPDC 24V/24V 20A	2627630000*	C.45
PRO TOPDC 24V/24V 20A	2627630000	D.28
PRO TOPDC 24V/24V 5A	2627650000*	C.45
PRO TOPDC 24V/24V 5A	2627650000	D.28
PRO TOPDC 24V/48V 10A	2627660000*	C.45
Project Coordination	2938820000	F.7
PSSRN K 24VDC 1D K 1000VDC 15A	2986930000	E.21
PV-STICK SET	1422030000	E.23
PV-STICK- VPE50	1303460000	E.23
PV-STICK- VPE50	1303500000	E.23
PVC DC 2I 10 2MPP RD SPD1R EVO 11	8000098970	E.22
PVHXW+M-W-XX06M-11	2814270000	E.23
PVHXW+M-W-XX06M-11	2814260000	E.23
PVHXW+M-W-XX06M-15	2814290000	E.23
PVHXW+M-W-XX06W-15	2814250000	E.23
PVHXW+M-W-XX06W+15	2814280000	E.23
PVHXW+M-W-XX06W+15	2814240000	E.23
PVHYM+XW-XX06M-11	2814210000	E.23
PVHYM+XW-XX06M-11	2814200000	E.23
PVHYW+XW-XX06W+15	2814190000	E.23
PVHYW+XW-XX06W+15	2814220000	E.23
PVHYW+XW-XX06W+15	2814180000	E.23
PVN DC 2I 10 1MPP RD CG 11	2778850000	E.22
PVN DC 2I 10 1MPP RD WM4 11	2778860000	E.22
PVN DC 2I 10 2MPP RD CG 11	2778780000	E.22
PVN DC 2I 10 2MPP RD WM4 11	2778880000	E.22
PVN DC 3IF 30 1MPP SPD1R CG 10	2683030000	E.22
PVN DC 3IF 30 1MPP SPD1R WM4 10	2683070000	E.22
PVN DC 3IF 30 1MPP SW SPD1R CG 10	2683050000	E.22
PVN DC 3IF 30 1MPP SW SPD1R WM4 10	2683090000	E.22
PVN DC 3IF 30 2MPP SPD1R CG 10	2683040000	E.22
PVN DC 3IF 30 2MPP SPD1R WM4 10	2683080000	E.22
PVN DC 3IF 30 2MPP SW SPD1R CG 10	2683060000	E.22
PVN DC 3IF 30 2MPP SW SPD1R WM4 10	2683100000	E.22
PVN1M1H6S0F3V100TXPX10	2737530000	E.22
PVN1M1H6S0F3V101TXPX10	2737480000	E.22
PVN1M1H6SXF3V100TXPX10	2737520000	E.22
PVN1M1H6SXF3V101TXPX10	2737440000	E.22
PWEB-DESIGNER-PRO	2857650000	F.12
PWEB-DESIGNER-PRO	2857650000	F.12
PWEB-ES-DESIGNER-2000_FREE	3037270000	F.12
PWEB-ES-DESIGNER-2000_FREE	3037270000	F.12
PWEB-ES-DESIGNER-2000_FREE	3037270000	F.16
PWEB-ES-RT-100/10	2982800000	F.12
PWEB-ES-RT-100/2	2982810000	F.12
PWEB-ES-RT-100/5	2982820000	F.12
PWEB-ES-RT-100/10	2982830000	F.12
PWEB-ES-RT-100/2	2982840000	F.12
PWEB-ES-RT-100/5	2982850000	F.12
PWEB-ES-RT-2000/10	2982860000	F.12
PWEB-ES-RT-2000/2	2982870000	F.12
PWEB-ES-RT-2000/5	2982880000	F.12
PWEB-ES-RT-50/10	2982890000	F.12
PWEB-ES-RT-50/2	2982900000	F.12

Type	Order No.	Page
SAI-4-M 5P M12 1:1	1806010000	D.21
SAI-4-M-MVV-M12 1:1	2009620000	D.21
SAI-8-M 5P M12 DL2	1816610000	D.21
SAIBP-M-5A-4/8-M12	2681620000	A.15
SAIL-M12BG-4S10T	1283321000	A.15
SAIL-M12G-2-X.XUBL	3107950300	D.21
SAIL-M12G-2SDX.XUBL	3108010300	D.21
SAIL-M12G-4SDX.XUBL	3108030300	D.21
SAIL-M12G-5-X.XUBL	3107980300	D.21
SAIL-M12W-2-X.XUBL	3107960300	D.21
SAIL-M12W-2SDX.XUBL	3108020300	D.21
SAIL-M12W-4SDX.XUBL	3108040300	D.21
SAIL-M12W-5-X.XUBL	3107990500	D.21
SAISP-M-5A-4/8-M12	2681600000	A.15
SCM 2CO P	7760056362	D.26
SCM 4CO P	7760056363	D.26
SCS 24VDC P1SIL3DS M	1303760000	D.27
SCS 24VDC P1SIL3ES LL	2633940000	D.27
SCS 24VDC P1SIL3ES LLT	2634010000	D.27
SCS 24VDC P2SIL3DES	1319270000	D.27
SCS 24VDC P2SIL3ES	1319280000	D.27
SCS 24VDC P2SIL3ES	1319280000	E.21
SDI 1CO P	7760056364	D.26
SDI 2CO P	7760056365	D.26
SL 3.50/02/90 3.2SN OR BX	1597210000	C.37
SL 3.50/03/90 3.2SN OR BX	1597220000	C.37
SL 3.50/04/90 3.2SN OR BX	1597230000	C.37
SL 3.50/05/90 3.2SN OR BX	1597240000	C.37
SL 3.50/06/90 3.2SN OR BX	1597250000	C.37
SL 3.50/07/90 3.2SN OR BX	1597260000	C.37
SL 3.50/08/90 3.2SN OR BX	1597270000	C.37
SL2C 10	3037500000	E.16
SL2C 6	3037380000	E.16
SL3C 6	3037410000	E.16
SL4C 6	3037440000	E.16
SLA Technical Support (PWEB/ResMa)	2938730000	F.7
SLA Technical Support (PWEB/ResMa)	2938730000	F.12
SLA Technical Support (PWEB/ResMa)	2938730000	F.16
SLA Update (ResMa)	3107540000	F.7
SU 10.161T/02/270MF2 3.5AG BK BX SO	1157310000	E.24
SU 10.161T/02/90MF2 3.5AG BK BX SO	1156650000	E.24
SV 7.62HP/02/180MF2 3.5SN BK BX	1048350000	E.24
SV 7.62HP/02/270MF2 3.5SN BK BX	1048370000	E.24
SV 7.62HP/02/90MF2 3.5SN BK BX	1048390000	E.24
SV 7.62IT/02/270MF2 3.5SN BK BX SO	1156490000	E.24
SV 7.62IT/02/90MF2 3.5SN BK BX SO	1156540000	E.24
<b>T</b>		
TGD ELM-12	2624990000	E.15
TGD ELM-4 CL2	2656670000	E.15
TGD ELM-6	2624980000	E.15
TGD FIM-C	2625000000	C.45
TGD FIM-C	2625000000	D.29
TGD FIM-C	2625000000	E.15
TOP 24-230VUC 24VDC2A ED2	2663080000	A.33
TOP 24VDC 230VAC1A	2618420000	A.33
TOP 24VDC 24VDC2A	2618720000	A.33
TRP 24-230VUC 1CO AGSNO ED2 PB	2855910000	C.38
TRP 24-230VUC 1CO ED2	2663010000	A.33
TRP 24-230VUC 1NO HC ED2	2663130000	A.33
TRP 24-230VUC 1NO HCP ED2	2663140000	A.33
TRP 24-230VUC 2CO ED2	2663040000	A.33
TRP 24-230VUC 2CO ED2	2663040000	C.38
TRP 24VDC 1CO	2618000000	A.33
TRP 24VDC 1CO	2618000000	D.26
TRP 24VDC 1CO 16A	2618100000	A.33
TRP 24VDC 1CO 16A	2618100000	D.26
TRP 24VDC 1CO AGSNO AU PB	2855830000	C.38
TRP 24VDC 1CO AGSNO PB	2855800000	C.38
TRP 24VDC 1CO AU	2618110000	A.33
TRP 24VDC 1NO HC	2618090000	A.33
TRP 24VDC 1NO HC	2618090000	C.38
TRP 24VDC 1NO HCP	2617930000	A.33
TRP 24VDC 1NO HCP	2617930000	C.38
TRP 24VDC 2CO	2618400000	A.33
TRP 24VDC 2CO	2618400000	C.38
TRP 24VUC 2CO FG	2706430000	A.33
TRP 24VUC 2CO FG	2706430000	E.21
TRPL 12-60VUC 1CO	2773770000*	C.38
TRPL 24-230VUC 1CO	2773860000*	C.38
TRPL 24VDC 1CO	2773890000	C.38
TRPL 24VDC 1CO	2773890000	D.26
TRS 24VDC 1CO AGSNO AU PB	2855860000	C.38
TRS 24VDC 1CO AGSNO PB	2855870000	C.38
TRS 24VUC 2CO FG	2706290000	E.21
<b>U</b>		
U-LINK-1-CONNECTION-1Y	2870130000	A.49
U-LINK-50-DEVICES-1Y	2870090000	A.49
U-LINK-50-DEVICES-1Y	2870090000	C.46
U-LINK-50-DEVICES-1Y	2870090000	D.34
U-OS-PWEB-ES-RT-1000/2	2941980000	F.12
U-OS-PWEB-ES-RT-1000/5	2941990000	F.12
U-OS-PWEB-ES-RT-1000/2	2942040000	F.12
U-OS-PWEB-ES-RT-1000/5	2942050000	F.12
U-OS-PWEB-ES-RT-2000/2	2942000000	F.12
U-OS-PWEB-ES-RT-2000/5	2942010000	F.12

Type	Order No.	Page
U-OS-PWEB-ES-RT-250/1_FREE	2987740000	F.12
U-OS-PWEB-ES-RT-250/2	3038630000	F.12
U-OS-PWEB-ES-RT-500/2	2941960000	F.12
U-OS-PWEB-ES-RT-500/5	2941970000	F.12
U-OS-PWEB-ES-RT-5000/2	2942020000	F.12
U-OS-PWEB-ES-RT-5000/5	2942030000	F.12
UC20-M3000	2639150000*	C.48
UC20-M3000	2639150000	D.35
UC20-M3000	2639150000	E.13
UC20-M4000	2639160000*	C.48
UC20-M4000	2639160000	D.35
UC20-WL2000-AC	1334950000	C.48
UC20-WL2000-AC	1334950000	D.35
UC20-WL2000-AC-CAN	2928020000*	C.48
UC20-WL2000-AC-CAN	2928020000	D.35
UR20-15AH-U16-DIAG	3039320000	D.36
UR20-16DI-P	1315200000	C.47
UR20-16DI-P	1315200000	D.36
UR20-16DO-P	1315250000	C.47
UR20-16DO-P	1315250000	D.36
UR20-1COM-232-485-422-V2	2826800000*	C.47
UR20-1COM-232-485-422-V2	2826800000	D.36
UR20-24Q-U16	2705630000*	C.47
UR20-24Q-U16	2705630000	D.36
UR20-4AH-HART-16-DIAG	2617520000*	C.47
UR20-4AH-HART-16-DIAG	2617520000	D.36
UR20-4AH-RTD-DIAG	1315700000	C.47
UR20-4AH-RTD-DIAG	1315700000	D.36
UR20-4AH-TC-DIAG	1315710000	C.47
UR20-4AH-TC-DIAG	1315710000	D.36
UR20-4AH-U16	1315620000	C.47
UR20-4AH-U16	1315620000	D.36
UR20-4AH-U16	1315620000	E.13
UR20-4AQ-U16	1315680000	C.47
UR20-4AQ-U16	1315680000	D.36
UR20-4DI-400-PN-FSPS-V2	2464570000	C.47
UR20-4DI-400-PN-FSPS-V2	2464570000	D.36
UR20-4DI-P	1315170000	C.47
UR20-4DI-P	1315170000	D.36
UR20-4DO-P	1315220000	C.47
UR20-4DO-P	1315220000	D.36
UR20-4DO-P-2A	1315230000	C.47
UR20-4DO-P-2A	1315230000	D.36
UR20-8DI-P-2W	1315180000	C.47
UR20-8DI-P-2W	1315180000	D.36
UR20-8DI-P-3W	1394400000	C.47
UR20-8DI-P-3W	1394400000	D.36
UR20-8DI-PN-FSPS-V2	2464590000	C.47
UR20-8DI-PN-FSPS-V2	2464590000	D.36
UR20-8DO-P	1315240000	C.47
UR20-8DO-P	1315240000	D.36
UR20-8BK-ACC	1346610000	E.13
UR20-FBC-CAN	1334890000	C.47
UR20-FBC-CAN	1334890000	D.36
UR20-FBC-CC	2625010000	C.47
UR20-FBC-CC	2625010000	D.36
UR20-FBC-CC-TSN	2680260000	C.47
UR20-FBC-CC-TSN	2680260000	D.36
UR20-FBC-DN	1334900000	C.47
UR20-FBC-DN	1334900000	D.36
UR20-FBC-EC	1334910000	C.47
UR20-FBC-EC	1334910000	D.36
UR20-FBC-EIP	1334920000	C.47
UR20-FBC-EIP	1334920000	D.36
UR20-FBC-IEC61162-450	2661310000	C.47
UR20-FBC-IEC61162-450	2661310000	D.36
UR20-FBC-MOD-TCP-V2	2476450000	C.47
UR20-FBC-MOD-TCP-V2	2476450000	D.36
UR20-FBC-PB-DP-V2	2614380000	C.47
UR20-FBC-PB-DP-V2	2614380000	D.36
UR20-FBC-PL	1334940000	C.47
UR20-FBC-PL	1334940000	D.36
UR20-FBC-PN-IRT-V2	2566380000	C.47
UR20-FBC-PN-IRT-V2	2566380000	D.36
UR20-PF-I	1334710000	C.47
UR20-PF-I	1334710000	D.36
UR20-PF-O	1334740000	C.47
UR20-PF-O	1334740000	D.36
UV20-B-IPC-2001.01	2676370000	D.35
UV20-B-IPC-3000.01	2676390000	D.35
<b>V</b>		
VDATA CAT6	1348590000	A.29
VDATA CAT6	1348590000	C.33
VDATA CAT6	1348590000	D.31
VG 21 HQ MS68 14-18	1016110000	E.19
VG M20 EXI 7-13 CR7J G4	2722250000	D.22
VG M25 EXI 12-17 CR7J G4	2722270000	D.22
VGM32-MS68 15-25 BG	1193610000	E.18
VGM40-MS68 20-32 BG	1193620000*	C.41
VGM40-MS68 20-32 BG	1193620000	D.23
VPU AC1 1+1 R 300/12.5 LH	2983530000	D.30
VPU AC1 3 R 275/25 LCF S	2726750000	D.30
VPU AC1 3 R 300/12.5 LH	2983560000	D.30
VPU AC1 3 R 440/25 LCF	2619170000	D.30
VPU AC1 3+1 R 275/25 LCF S 2PE	2726770000*	C.33
VPU AC1 3+1 R 275/25 LCF S 2PE	2726770000	D.30
VPU AC1 3+1 R 300/12.5 LH	2983590000	D.30

Type	Order No.	Page
VPU AC1 3+1 R 440/25 LCF	2619260000	A.29
VPU AC1 3+1 R 440/25 LCF	2619260000	D.30
VPU AC1 F 1 R 275/25	2859340000	D.30
VPU AC1 I 1+1 300/50	2591060000	C.33
VPU AC1 I 1+1 300/50	2591070000	A.29
VPU AC1 I 1+1 300/50	2591070000	D.30
VPU AC1 I 1+1 R 300/50 Y	2639340000	A.29
VPU AC1 I 2 300/50	2591040000	D.30
VPU AC1 I 2 R 480/50	2591240000	D.30
VPU AC1 I 2 R 75/50	2591630000	D.30
VPU AC1 I 3 R 300/50 Y	2639330000	A.29
VPU AC1 I 3 R 350/50	2591110000	A.29
VPU AC1 I 3 R 750/35	2591320000	A.29
VPU AC1 I 3+1 R 300/50	2591090000	C.33
VPU AC1 I 3+1 R 300/50	2591090000	D.30
VPU AC1 I 4 480/50	2591270000	D.30
VPU DC1 I 3 R 1000/40	1318620000*	E.20
VPU DC1 I 3 R 1500/40	1318630000*	E.20
VPU DC1 I 3 R 500/40	1318610000*	E.20
VPU DC1 I 3 R 1000/40	1318640000*	E.20
VPU II 1 1000V/40KA AC	1473440000	A.29
VPU II 1 R 1000V/40KA AC	2811930000	A.29
VPU III R 230V/6KV AC	1351650000	D.30
VPU III R 24V/4KV AC/DC	1351580000	D.30
VPU PVI-II 3 R 1500	2530590000	C.33
VPU PVI 3 R 1500	2530650000	C.33
VSPC 2CL 24VDC EX	8953720000	D.31
VSPC 2CL HF 24VDC R	8951700000	D.31
VSPC 2SL 24VAC R	8951640000	A.29
VSPC 4SL 24VAC R	8951600000	A.29
VSPC 4SL 24VDC EX	1161190000	D.31
VSPC BASE 2CL FG R	8951720000	D.31
VSPC BASE 2CL FG EX	8951820000	D.31
VSPC BASE 2SL FG R	8951780000	A.29
VSPC BASE 4SL FG EX	8951840000	D.31
VSPC BASE 4SL FG R	8951760000	A.29
VSPC CONTROL UNIT 24VDC	8972270000	D.31
VSPC RS485 2CH R	8951670000	D.31
VSSCA CL FG 24VAC/DC EX	1063810000	D.31
VSSCC RS485	1064980000	D.31
VSSCC RS485 PA EX	1065020000	D.31
VSSCC CL 24VAC/DC 0.5A	1064170000	D.31
VSSCC TR SL FG 24VAC/DC EX	1421440000	D.31
VSSCC TRSL 24VAC/DC 0.5A	1354790000	D.31
VT DIGI PRO	9918870000	E.12
<b>W</b>		
WBC-CH-10RE-BK-95-0032	3072570000	C.30
WBC-CH-60R-BK-25-0023	2938270000	C.30
WBC-P-10BK-70	2991900000	C.26
WBC-P-10BK-95	2991940000	C.26
WBC-P-10RE-70	2991910000	C.28
WBC-P-10RE-95	2991950000	C.28
WBC-P-6BK-16	2905270000	C.16
WBC-P-6BK-25	2905290000	C.16
WBC-P-6OR-16	2905280000	C.18
WBC-P-6OR-25	2905300000	C.18
WBC-P-8BK-35	2905350000	C.20
WBC-P-8BK-50	2905370000	C.20
WBC-P-8BK-70	2995040000	C.24
WBC-P-8OR-35	2905360000	C.21
WBC-P-8OR-50	2905380000	C.21
WBC-P-8OR-70	2995050000	C.25
WBC-S-10BK-M8	2991920000	C.27
WBC-S-10RE-M8	2991930000	C.29
WBC-S-6BK-B	2905330000	C.17
WBC-S-6OR-B	2905340000	C.19
WBC-S-8BK-B	2905310000	C.22
WBC-S-8BK-M6	2918840000	C.22
WBC-S-8OR-B	2905320000	C.23
WBC-S-8OR-M6	2918860000	C.23
WDK 2.5N	1041600000	C.35
WDK 2.5N V	1041610000	C.35
WDK 2.5PE	1036300000	C.35
WDK 4N V	1041910000	C.35
WDU 1.5/ZZ	1031400000	C.35
WDU 10	1020300000	D.20
WDU 16 BL	1020480000	C.35
WDU 16N	1036100000	C.35
WDU 2.5	1020000000	C.35
WDU 2.5	1020000000	D.20
WDU 2.5N	1023700000	C.35
WDU 4	1020100000	C.35
WDU		



Order No.	Type	Page
-----------	------	------

## 1000000000

1002940000	HDC C HX SM6.0AG	E.19
1002980000	HDC C HX BM6.0AG	E.19
1003080000	HDC HQM TOLLU 1PG21	E.19
1003160000	HDC HQ 4/2 FC	E.19
1003170000	HDC HQ 4/2 MC	E.19

## 1010000000

1010100000	WPE 4	C.35
1016110000	VG 21 HQ MS68 14-18	E.19
1016200000	WPE 2.5N	C.35
1018790000	IE-FCM-RJ45-C	C.46
1018790000	IE-FCM-RJ45-C	D.34

## 1020000000

1020000000	WDU 2.5	C.35
1020000000	WDU 2.5	D.20
1020100000	WDU 4	C.35
1020100000	WDU 4	D.20
1020200000	WDU 6	D.20
1020300000	WDU 10	D.20
1020480000	WDU 16 BL	C.35
1023700000	WDU 2.5N	C.35

## 1030000000

1031400000	WDU 1.5/ZZ	C.35
1036100000	WDU 16N	C.35
1036300000	WDK 2.5PE	C.35

## 1040000000

1041600000	WDK 2.5N	C.35
1041610000	WDK 2.5N V	C.35
1041910000	WDK 4N V	C.35
1048350000	SV 7.62HP/02/180MF2 3.5SN BK BX	E.24
1048370000	SV 7.62HP/02/270MF2 3.5SN BK BX	E.24
1048390000	SV 7.62HP/02/90MF2 3.5SN BK BX	E.24

## 1060000000

1063810000	VSSC4 CL FG 24VAC/DC EX	D.31
1064170000	VSSC6 CL 24VAC/DC 0.5A	D.31
1064980000	VSSC6 RS485	D.31
1065020000	VSSC6 RS485 PA EX	D.31

## 1070000000

1079830000	HDC HP 550 F 150	E.18
1079920000	HDC IP68 HP 24B AS S	D.23
1079920000*	HDC IP68 HP 24B AS S	C.41
1079930000	HDC IP68 HP 24B TO	D.23
1079930000	HDC IP68 HP 24B TO	E.18
1079930000*	HDC IP68 HP 24B TO	C.41

## 1100000000

1103710000	HDC 24B HP550 MPL2 TYP1	D.23
1103710000*	HDC 24B HP550 MPL2 TYP1	C.41
1103720000	HDC 24B HP550 MPL3 TYP1	E.18
1103770000	HDC 24B HP550 MPL2 TYP2	D.23
1103770000*	HDC 24B HP550 MPL2 TYP2	C.41
1103780000	HDC 24B HP550 MPL3 TYP2	E.18

## 1110000000

1119110000	HDC HP 550 M 150	E.18
1119980000	HDC IP68 24B MD 3M32	E.18
1119990000	HDC IP68 24B MD 2M40	D.23
1119990000*	HDC IP68 24B MD 2M40	C.41

## 1120000000

1120040000	HDC IP68 HP 24B A	D.23
1120040000	HDC IP68 HP 24B A	E.18
1120040000*	HDC IP68 HP 24B A	C.41
1120590000	HDC HP 550 M 240	D.23
1120590000*	HDC HP 550 M 240	C.41
1120600000	HDC HP 550 F 240	D.23
1120600000*	HDC HP 550 F 240	C.41

## 1130000000

1137780000	WSI 25/1 10X38/LED 1KV	C.35
1137790000	WSI 25/1 10X38 1KV	C.35

## 1150000000

1156490000	SV 7.62IT/02/270MF2 3.5SN BK BX SO	E.24
1156540000	SV 7.62IT/02/90MF2 3.5SN BK BX SO	E.24
1156600000	BUZ 10.16IT/02/180MF2 AG BK BX	E.24
1156650000	SU 10.16IT/02/90MF2 3.5AG BK BX SO	E.24
1156710000	BVZ 7.62IT/02/180MF2 SN BK BX	E.24
1157310000	SU 10.16IT/02/270MF2 3.5AG BK BX SO	E.24

Order No.	Type	Page
-----------	------	------

## 1160000000

1161190000	VSPC 4SL 24VDC EX	D.31
1165940002	IE-C6FP8LD0002M40M40-D	C.46
1165940002	IE-C6FP8LD0002M40M40-D	D.34

## 1190000000

1193610000	VGM32-MS68 15-25 BG	E.18
1193620000	VGM40-MS68 20-32 BG	D.23
1193620000*	VGM40-MS68 20-32 BG	C.41
1194900000	KTB MH 403015 S4E0	D.32
1194910000	KTB MH 403015 S4E1	D.32
1194920000	KTB MH 403015 S4E2	D.32
1194930000	KTB MH 403015 S4E3	D.32
1194940000	KTB MH 403015 S4E4	D.32
1194950000	KTB MH 403020 S4E1	D.32
1194960000	KTB MH 403020 S4E1	D.32
1194970000	KTB MH 403020 S4E2	D.32
1194980000	KTB MH 403020 S4E3	D.32
1194990000	KTB MH 403020 S4E4	D.32
1195000000	KTB MH 453815 S4E0	D.32
1195010000	KTB MH 453815 S4E1	D.32
1195020000	KTB MH 453815 S4E2	D.32
1195030000	KTB MH 453815 S4E3	D.32
1195040000	KTB MH 453815 S4E4	D.32
1195050000	KTB MH 453820 S4E0	D.32
1195060000	KTB MH 453820 S4E1	D.32
1195070000	KTB MH 453820 S4E2	D.32
1195080000	KTB MH 453820 S4E3	D.32
1195090000	KTB MH 453820 S4E4	D.32

## 1200000000

1200220000	KTB QL 403015 S4E0	D.32
1200230000	KTB QL 403015 S4E1	D.32
1200240000	KTB QL 403015 S4E2	D.32
1200250000	KTB QL 403015 S4E3	D.32
1200260000	KTB QL 403015 S4E4	D.32
1200270000	KTB QL 403020 S4E0	D.32
1200280000	KTB QL 403020 S4E1	D.32
1200290000	KTB QL 403020 S4E2	D.32
1200310000	KTB QL 403020 S4E3	D.32
1200320000	KTB QL 403020 S4E4	D.32
1200330000	KTB QL 453815 S4E0	D.32
1200340000	KTB QL 453815 S4E1	D.32
1200350000	KTB QL 453815 S4E2	D.32
1200360000	KTB QL 453815 S4E3	D.32
1200370000	KTB QL 453815 S4E4	D.32
1200380000	KTB QL 453820 S4E0	D.32
1200390000	KTB QL 453820 S4E1	D.32
1200410000	KTB QL 453820 S4E2	D.32
1200420000	KTB QL 453820 S4E3	D.32
1200430000	KTB QL 453820 S4E4	D.32

## 1210000000

1211100000	HDC HE 24 MS	C.39
1211100000	HDC HE 24 MS	D.24
1211300000	HDC HE 24 FS	C.39
1211300000	HDC HE 24 FS	D.24
1211300000	HDC HE 24 FS	C.39
1214300000	HDC 24B ADLU	D.23
1214300000	HDC 24B ADLU	D.24
1218390000	RCIKITZ 24VDC 2C0 LD/LFG	A.33
1219480000	PWR173024L	D.26

## 1220000000

1220150000	DRH276024LT	D.26
------------	-------------	------

## 1280000000

1283321000	SAIL-M12BG-4S10T	A.15
1285830000	IE-CST-2TX-1RS232/485	A.49
1285840000	IE-CST-2TX-2RS232/485	A.49
1286900000	IE-MC-VLT-1TX-1SCS	D.34

## 1300000000

1303460000	PV-STICK-VPE50	E.23
1303500000	PV-STICK-VPE50	E.23
1303760000	SCS 24VDC P2SIL3DS M	D.27

## 1310000000

1315170000	UR20-4DI-P	C.47
1315170000	UR20-4DI-P	D.36
1315180000	UR20-8DI-P-2W	C.47
1315180000	UR20-8DI-P-2W	D.36
1315200000	UR20-16DI-P	C.47
1315200000	UR20-16DI-P	D.36
1315220000	UR20-4DO-P	C.47
1315220000	UR20-4DO-P	D.36
1315230000	UR20-4DO-P-2A	C.47
1315230000	UR20-4DO-P-2A	D.36
1315240000	UR20-8DO-P	C.47
1315240000	UR20-8DO-P	D.36
1315250000	UR20-16DO-P	C.47

Order No.	Type	Page
-----------	------	------

1315250000	UR20-16DO-P	D.36
1315620000	UR20-4AI-UH16	C.47
1315620000	UR20-4AI-UH16	E.16
1315620000	UR20-4AI-UH16	D.36
1315680000	UR20-4AD-UH16	C.47
1315680000	UR20-4AD-UH16	D.36
1315700000	UR20-4AI-RTD-DIAG	C.47
1315700000	UR20-4AI-RTD-DIAG	D.36
1315710000	UR20-4AI-TC-DIAG	C.47
1315710000	UR20-4AI-TC-DIAG	D.36
1319270000	SCS 24VDC P2SIL3DS ES	D.27
1319280000	SCS 24VDC P2SIL3ES	D.27
1319280000	SCS 24VDC P2SIL3ES	E.21

## 1330000000

1334710000	UR20-PF-J	C.47
1334710000	UR20-PF-J	D.36
1334740000	UR20-PF-O	C.47
1334740000	UR20-PF-O	D.36
1334890000	UR20-FBC-CAN	C.47
1334890000	UR20-FBC-CAN	D.36
1334900000	UR20-FBC-DN	C.47
1334900000	UR20-FBC-DN	D.36
1334910000	UR20-FBC-EC	C.47
1334910000	UR20-FBC-EC	D.36
1334920000	UR20-FBC-EIP	C.47
1334920000	UR20-FBC-EIP	D.36
1334940000	UR20-FBC-PL	C.47
1334940000	UR20-FBC-PL	D.36
1334950000	UC20-WL2000-AC	C.48
1334950000	UC20-WL2000-AC	D.35

## 1340000000

1346610000	UR20-EBK-ACC	E.13
1348590000	VDATA CAT6	A.29
1348590000	VDATA CAT6	C.33
1348590000	VDATA CAT6	D.31

## 1350000000

1351580000	VPU III R 24V/4KV AC/DC	D.30
1351650000	VPU III R 230V/8KV AC	D.30
1354790000	VSSC6TRSL24VAC/DC0.5A	D.31
1354950000	HDC HOP ALU CS	E.19

## 1370000000

1370050010	CP DC UPS 24V 20A/10A	C.46
1370050010	CP DC UPS 24V 20A/10A	D.29

## 1390000000

1394400000	UR20-8DI-P-3W	C.47
1394400000	UR20-8DI-P-3W	D.36

## 1420000000

1421440000	VSSC6 TR SL FG 24VAC/DC EX	D.31
1422030000	PV-STICK SET	E.23
1429040000	HDC MDU	D.24
1429050000	HDC MF 24B AF	D.23
1429070000	HDC MF 24B FA	D.23

## 1430000000

1433810000*	RJ45C5 T1V 3.2N4N TY	C.37
1433890000*	RJ45C5 STD 2.7N4N RL	C.37
1433900000*	RJ45C5 STV 2.7N4N RL	C.37

## 1470000000

1473440000	VPU II 1 1000V/40KA AC	A.29
1478100000	PRO MAX 72W 24V 3A	C.44
1478100000	PRO MAX 72W 24V 3A	D.29

Order No.	Type	Page
1824440000	LSF-SMT 3.50/04/90 3.5SN BK TU	C.37
1824450000	LSF-SMT 3.50/05/90 3.5SN BK TU	C.37
1824460000	LSF-SMT 3.50/06/90 3.5SN BK TU	C.37
1824470000	LSF-SMT 3.50/07/90 3.5SN BK TU	C.37
1824480000	LSF-SMT 3.50/08/90 3.5SN BK TU	C.37

## 1850000000

1855610000	WTR 2.5	C.35
------------	---------	------

## 1860000000

1868350000	SAI-04D-VPPP-2A-M120-NAM-EX	D.21
------------	-----------------------------	------

## 1870000000

1873580000	HDC HE 24 FP	C.39
1873580000	HDC HE 24 FP	D.24
1873590000	HDC HE 24 MP	C.39
1873590000	HDC HE 24 MP	D.24

## 1880000000

1880430000	WSI 4/2	E.17
1886580000	WSI 4	C.35

## 1890000000

1894380000	SAI-08D-VPPP-2A-M120-NAM-EX	D.21
------------	-----------------------------	------

## 1900000000

1904440000	HDC 64D SDLU 1M32G	C.39
1904440000	HDC 64D SDLU 1M32G	D.23
1904440000	HDC 64D SDLU 1M32G	D.24

## 1960000000

1963600000	IE-PS-RJ45-FH-BK	C.46
1963600000	IE-PS-RJ45-FH-BK	D.34

## 1980000000

1988590000	LUF 10.00/01/90 5.0SN BK BX	C.37
1988600000	LUF 10.00/02/90 5.0SN BK BX	C.37
1988610000	LUF 10.00/03/90 5.0SN BK BX	C.37
1988620000	LUF 10.00/04/90 5.0SN BK BX	C.37
1988630000	LUF 10.00/05/90 5.0SN BK BX	C.37
1988900000	ADT 2.5 2C	C.34
1988960000	ADT 2.5 4C	C.34

## 1990000000

1991780000	ALO 6	E.17
------------	-------	------

## 2000000000

2009620000	SAI-4-M-MVV-M12 1:1	D.21
------------	---------------------	------

## 2050000000

2051180000	A2C 4	C.34
2051240000	A3C 4	C.34
2051410000	A3C 4 PE	C.34
2051500000	A4C 4	C.34
2051500000	A4C 4	E.16

## 2080000000

2080360000	AMG ELM-6	A.37
2080410000	AMG ELM-12	A.37
2080420000	AMG ELM-1F	A.37
2080480000	AMG ELM-2F	A.37
2080490000	AMG ELM-4F	A.37
2080500000	AMG ELM-6F	A.37
2080600000	AMG ELM-8F	A.37
2080650000	AMG ELM-10F	A.37
2081870000	AMG FIM-0	A.37
2081880000	AMG FIM-C	A.37
2081900000	AMG CM	C.45
2081900000	AMG CM	D.29
2082770000	AMG AM CO	C.45
2082770000	AMG AM CO	D.29
2083360000	AMG CM EX	D.29

## 2120000000

2122910000	AMG OD	A.37
2122910000	AMG OD	E.15
2122920000	AMG PD	A.37
2122920000	AMG PD	C.45
2122920000	AMG PD	D.29
2122920000	AMG PD	E.15
2122930000	AMG MD	A.37
2122930000	AMG MD	C.45
2122930000	AMG MD	D.29
2122930000	AMG MD	E.15
2122940000	AMG XMD	A.37
2123000000	AMG PP	A.37

Order No.	Type	Page
2123050000	AMG DIS	C.45
2123050000	AMG DIS	D.29
2123050000	AMG DIS	E.15

## 2420000000

2425520000	ENERGY LOGGER D550	D.37
2429850000	ADT 4 2C	C.34
2429860000	AFS 4 2C BK	C.34

## 2430000000

2434390000	AFS 4 2C 100-250V BK	C.34
------------	----------------------	------

## 2440000000

2447950000	ACT20P-PRO-FI-AD-DO-P	D.25
2448100000	ACT20P-PRO-RTCI-AD-DO-S	D.25

## 2450000000

2456080000	ACT20X-2HDI-2SD0-RNO-P	D.25
2456100000	ACT20X-2HDI-2SD0-P	D.25
2456130000	ACT20X-2SDI-2HDO-P	D.25
2456150000	ACT20X-2HAI-2SAO-P	D.25
2456170000	ACT20X-2SAI-2HAI-P	D.25
2456190000	ACT20X-2HTI-2SAO-P	D.25
2456200000	ACT20X-HUI-SAO-P	D.25
2458950000	BLF 3.50/02/180 SN OR BX	C.37
2459060000	BLF 3.50/03/180 SN OR BX	C.37
2459070000	BLF 3.50/04/180 SN OR BX	C.37
2459080000	BLF 3.50/05/180 SN OR BX	C.37
2459090000	BLF 3.50/06/180 SN OR BX	C.37
2459100000	BLF 3.50/07/180 SN OR BX	C.37
2459110000	BLF 3.50/08/180 SN OR BX	C.37

## 2460000000

2460640000	IE-FC-SET-IPDEED003-KY-M	D.34
2460640000*	IE-FC-SET-IPDEED003-KY-M	C.46
2464570000	UR20-4DI-4DO-PN-FSPS-V2	C.47
2464570000	UR20-4DI-4DO-PN-FSPS-V2	C.36
2464590000	UR20-8DI-PN-FSPS-V2	C.47
2464590000	UR20-8DI-PN-FSPS-V2	D.36
2466870000	PRO TOP1 120W 24V 5A	A.37
2466870000	PRO TOP1 120W 24V 5A	C.44
2466870000	PRO TOP1 120W 24V 5A	D.28
2466880000	PRO TOP1 240W 24V 10A	A.37
2466880000	PRO TOP1 240W 24V 10A	C.44
2466880000	PRO TOP1 240W 24V 10A	D.28
2466890000	PRO TOP1 480W 24V 20A	A.37
2466890000	PRO TOP1 480W 24V 20A	C.44
2466890000	PRO TOP1 480W 24V 20A	D.28
2466900000	PRO TOP1 960W 24V 40A	C.44
2466900000	PRO TOP1 960W 24V 40A	D.28
2466920000	PRO TOP1 960W 48V 20A	C.44
2466960000	PRO COM DISPLAY 7S	C.45
2466960000	PRO COM DISPLAY 7S	D.28
2466990000	PRO TOP1 240W 24V 5A EX	D.28
2467000000	PRO TOP1 240W 24V 10A EX	D.28
2467000000	PRO TOP1 480W 24V 20A EX	D.28
2467010000	PRO TOP1 960W 24V 40A EX	D.28
2467030000	PRO TOP1 480W 48V 10A	A.37
2467060000	PRO TOP3 120W 24V 5A	C.44
2467070000	PRO TOP3 120W 24V 5A CO	C.44
2467070000	PRO TOP3 120W 24V 5A CO	D.28
2467080000	PRO TOP3 240W 24V 10A	A.37
2467090000	PRO TOP3 240W 24V 10A CO	C.44
2467090000	PRO TOP3 240W 24V 10A CO	D.28
2467100000	PRO TOP3 480W 24V 20A	A.37
2467110000	PRO TOP3 480W 24V 20A CO	C.44
2467110000	PRO TOP3 480W 24V 20A CO	D.28
2467130000	PRO TOP3 960W 24V 40A CO	C.44
2467130000	PRO TOP3 960W 24V 40A CO	D.28
2467150000	PRO TOP3 480W 48V 10A	C.44
2467170000	PRO TOP3 960W 48V 20A	C.44
2467320000	PRO COM CAN OPEN	A.37
2467320000	PRO COM CAN OPEN	C.45
2467320000	PRO COM CAN OPEN	D.28
2467320000	PRO COM CAN OPEN	E.15
24689370000	A2T 1.5	C.34

## 2470000000

2471520000	LLF 7.50/01/90 5.0SN BK BX	E.24
2473420000	LLFS 7.50/01/90 5.0SN BK BX	E.24
2476450000	UR20-FBC-MOD-TCP-V2	C.47
2476450000	UR20-FBC-MOD-TCP-V2	D.36

## 2480000000

2489740000	ACT20P-CI-V0-P	D.25
------------	----------------	------

## 2490000000

2490520000	A3C 10	E.16
2491110000	LLFS 7.50/01/180 5.0SN BK BX	E.24
2491810000	LUF 10.00/01/180 5.0SN BK BX	E.24
2491820000	LUF 15.00/02/180V 5.0SN BK BX	E.24

Order No.	Type	Page
2492000000	LUF 15.00/02/90V 5.0SN BK BX	E.24
2494090000	A3C 16	E.16
2495100000	AMG DIS EX	D.29
2499440000	LUF 15.00/02/90V 5.0SN BK BX	E.24

## 2500000000

2500560000	LUF 10.00/01/90 5.0SN BK BX	E.24
2500760000	AMG EP KIT	A.37
2502280000	ALO 16	E.17
2502530000	WPD 130 1X50/1X50 GY	D.20
2502750000	WPD 132 1X185/1X185 GY	D.20
2502850000	WPD 133 1X300/1X300 GY	D.20
2503090000	WPD 131 1X95/1X95 GY	D.20

## 2510000000

2514620000	ACT20P-CI-CO-P-P	D.25
2518380000*	RJ45C5 RIV 3.2N4G/Y TY	C.37

## 2530000000

2530590000	VPU PV I+II 3 R 1500	C.33
2530650000	VPU PV II 3 R 1500	C.33
2531290000	A2T 2.5 3C	C.34
2534160000	ENERGY ANALYSER 750-24	D.37
2536650000	IE-WLT-BL-AP-CLEU	A.49
2536650000	IE-WLT-BL-AP-CLEU	C.46
2536650000	IE-WLT-BL-AP-CLEU	D.34
2536690000	IE-WLT-VL-AP-BR-CLEU	A.49

## 2540000000

2540910000	ENERGY METER 750-230	D.37
------------	----------------------	------

## 2550000000

2551510000	A2C 35	C.34
2551510000	A2C 35	E.16
2551520000	A2C 35 PE	C.34
2551520000	A2C 35 PE	E.16
2552090000	A2C 35 BL	C.34
2552090000	A2C 35 BL	E.16

## 2560000000

2562140000	RJ45M RIV 1.9N4YG/YG TY	C.37
2562950000*	RJ45C5 RIU 2 8N4G/Y RL	C.37
2563810002	IE-C6FP8L0002M40M40-0	C.37
2563810005	IE-C6FP8L0005M40M40-0	C.37
2563810010	IE-C6FP8L0010M40M40-0	C.37
2563810020	IE-C6FP8L0020M40M40-0	C.37
2566380000	UR20-FBC-PN-IRT-V2	C.47
2566380000	UR20-FBC-PN-IRT-V2	D.36

## 2570000000

2576140000	DRMKITP 24VDC 4CD LD/PB	A.33
2576190000	DRIKITP 24VDC 2CD LD/PB	A.33

## 2580000000

2583090000	AAC 35 2X6	E.16
2583170000	AAC 35 2X6 BL	E.16
2583180000	AAC 35 2X6 GN-YL	E.16
2583350000	CABTITTE BSE SML GY	D.33
2583450000	CABTITTE SE 5-6 SML GY	D.33
2583460000	CABTITTE SE 6-7 SML GY	D.33
2584520000	CABTITTE BSE LRG GY	D.33
2584610000	CABTITTE SE 10-11 SML GY	D.33
2584890000	CABTITTE SE 2/5-6 SML GY	D.33
2587360000	PRO COM IO-LINK	A.37
2587360000	PRO COM IO-LINK	C.45
2587360000	PRO COM IO-LINK	D.28
2587360000	PRO COM IO-LINK	E.15

##

Order No.	Type	Page
2682280000	IE-SW-AL08M-8TX	A.49
2682290000	IE-SW-AL08M-6TX-2GT	A.49
2682310000	IE-SW-AL16M-16TX	A.49
2682320000	IE-SW-AL24M-24TX	A.49
2682330000	IE-SW-AL18M-16TX-2GC	A.49
2682340000	IE-SW-AL12M-8GT-4GESFP	A.49
2682340000	IE-SW-AL12M-8GT-4GESFP	C.46
2682340000	IE-SW-AL12M-8GT-4GESFP	D.34
2682350000	IE-SW-AL08M-8GT	A.49
2682350000	IE-SW-AL08M-8GT	D.34
2682360000	IE-SW-AL14M-12GT-2GESFP	A.49
2682370000	IE-SW-AL24M-16GT-8GESFP	A.49
2682380000	IE-SW-EL08-8POE	C.46
2682380000	IE-SW-EL08-8POE	D.34
2682420000	IE-SW-AL08M-8GTPOE	A.49
2682430000	IE-SW-AL06M-4GTPOE-2GESFP	A.49
2682500000	IE-SFP-1GE-SM-10	C.46
2682500000	IE-SFP-1GE-SM-10	D.34
2682600000	IE-CS-MBGW-2TX-1COM	A.49
2682600000	IE-CS-MBGW-2TX-1COM	C.46
2682600000	IE-CS-MBGW-2TX-1COM	D.34
2682620000	IOT-GW30	D.35
2682630000	IOT-GW30-4AG-EU	D.35
2683030000	PVN DC 3IF 30 1MPP SPD1R CG 10	E.22
2683040000	PVN DC 3IF 30 2MPP SPD1R CG 10	E.22
2683050000	PVN DC 3IF 30 1MPP SW SPD1R CG 10	E.22
2683060000	PVN DC 3IF 30 2MPP SW SPD1R CG 10	E.22
2683070000	PVN DC 3IF 30 1MPP SPD1R WM4 10	E.22
2683080000	PVN DC 3IF 30 2MPP SPD1R WM4 10	E.22
2683090000	PVN DC 3IF 30 1MPP SW SPD1R WM4 10	E.22
2683100000	PVN DC 3IF 30 2MPP SW SPD1R WM4 10	E.22

## 2690000000

2694060000	A2C 95/120	E.16
2694070000	A2C 95/120 BL	E.16
2694090000	A2C 95/120 PE	E.16

## 2700000000

2705630000	UR20-2A0-UI-16	D.36
2705630000*	UR20-2A0-UI-16	C.47
2706290000	TRS 24VUC 2C0 FG	E.21
2706430000	TRP 24VUC 2C0 FG	A.33
2706430000	TRP 24VUC 2C0 FG	E.21

## 2710000000

2710070000	ATTB 6	D.20
2710080000	ATTB 6 PE	D.20
2710090000	WTTB 6	D.20
2710100000	WTTB 6 PE	D.20

## 2720000000

2720550000	BVDF 7.62HP/02/180MF2 SN BK BX	E.24
2722250000	VG M20 EX1 7-13 CRJ7 G4	D.22
2722270000	VG M25 EX1 12-17 CRJ7 G4	D.22
2725850010	IE-S1DS2VE0010T01T01-E	C.36
2725850020	IE-S1DS2VE0020T01T01-E	C.36
2725850030	IE-S1DS2VE0030T01T01-E	C.36
2725850050	IE-S1DS2VE0050T01T01-E	C.36
2726010000	IE-PCB-SPE-P-90V2.1-THR RL	C.36
2726750000	VPU AC I 3 R 275/25 LCF S	D.30
2726770000	VPU AC I 3+1 R 275/25 LCF S 2PE	D.30
2726770000*	VPU AC I 3+1 R 275/25 LCF S 2PE	C.33
2728620000	AWPD 35 4X6/6X2.5	E.17
2728700000	A2C 150/185	E.16
2728710000	A2C 150/185 BL	E.16

## 2730000000

2737440000	PVN1M1H6SX3V101TTPX10	E.22
2737480000	PVN1M1H6SF3V101TTPX10	E.22
2737520000	PVN1M1H6SX3V100TTPX10	E.22
2737530000	PVN1M1H6SF3V100TTPX10	E.22
2739630000	IE-SR-4TX-LTE/4G-USEMEA	A.49

## 2740000000

2740420000	IE-SW-AL10M-8TX-2GC	A.49
2741400000	MHS 5/02 H T3 B T	C.36
2741420000	MHS 5/03 H T3 B T	C.36
2741430000	MHS 5/04 H T3 B T	C.36
2741440000	MHS 5/05 H T3 B T	C.36
2741450000	MHS 5/06 H T3 B T	C.36
2741460000	MHS 5/07 H T3 B T	C.36
2741470000	MHS 5/08 H T3 B T	C.36
2741560000	MPS 5/02 S TN B B	C.36
2741570000	MPS 5/03 S TN B B	C.36
2741580000	MPS 5/04 S TN B B	C.36
2741590000	MPS 5/05 S TN B B	C.36
2741600000	MPS 5/06 S TN B B	C.36
2741610000	MPS 5/07 S TN B B	C.36
2741620000	MPS 5/08 S TN B B	C.36
2744110000	A2T 2.5 DT,DT	C.34
2747100000	FMH3 S1/26V F1 B RL	C.37
2747130000	FMH3 S1/50V F1 B RL	C.37
2747370000	FFH9 S1/26V F1 B RL	C.37

Order No.	Type	Page
2747400000	FFH9 S1/50V F1 B RL	C.37
2747580000	FFP D1/50H S1 B TY	C.37
2748240000	HDC MHP 200 MAS	D.23
2748250000	HDC MHP 200 FAS	D.23
2748280000	HDC MHP 100 MAS	D.23
2748290000	HDC MHP 100 FAS	D.23
2748300000	HDC MHP 70 MAS	D.23
2748310000	HDC MHP 70 FAS	D.23
2748420000	HDC MHE 6 MP	D.24
2748430000	HDC MHE 6 FP	D.24
2748440000	HDC MHE 8 MP	D.24
2748450000	HDC MHE 8 FP	D.24
2748460000	HDC MHD 12 MP	D.24
2748470000	HDC MHD 12 FP	D.24

## 2750000000

2751270000	IE-SR-4TX	A.49
2751280000	IE-SR-4TX-LTE/4G-EU	A.49
2751280000	IE-SR-4TX-LTE/4G-EU	C.46
2759070000	FSKIT 24VDC 3NO1NC FG LD AGSNO AU	D.27
2759080000	FSKIT 24VDC 2NO2NC FG LD AGSNO AU	D.27
2759090000	FSKIT 24VDC 4NO2NC FG LD AGSNO AU	D.27
2759100000	FSKIT 24VDC 3NO3NC FG LD AGSNO AU	D.27

## 2770000000

2772800000	HDC MHX 4P MP	D.23
2772810000	HDC MHX 4P FP	D.23
2773770000*	TRPL 12-60VUC 1C0	C.38
2773860000*	TRPL 24-230VUC 1C0	C.38
2773890000	TRPL 24VDC 1C0	C.38
2773890000	TRPL 24VDC 1C0	D.26
2778850000	PVN DC 2I 10 1MPP RD CG 11	E.22
2778860000	PVN DC 2I 10 1MPP RD WM4 11	E.22
2778870000	PVN DC 2I 10 2MPP RD CG 11	E.22
2778880000	PVN DC 2I 10 2MPP RD WM4 11	E.22
2778970000	IE-SW-SL20M-8GT-12GESFP-HV	C.46
2779000000	IE-SW-SL26M-24TX-2GC-LV	D.34
2779010000	IE-SW-SL28M-HV	C.46

## 2780000000

2783160000	FUSE 10X38 1A 1000 VDC GPV	E.23
2789910000	DURA ECO LA-BAT 24V 7AH	C.45
2789910000	DURA ECO LA-BAT 24V 7AH	D.29
2789920000	DURA ECO LA-BAT 24V 12AH	C.45
2789920000	DURA ECO LA-BAT 24V 12AH	D.29
2789930000	DURA ECO LA-BAT 24V 17AH	C.45
2789930000	DURA ECO LA-BAT 24V 17AH	D.29

## 2790000000

2795120000	IE-PCB-SPE-P-90V2.1-THR-YG/YG RL	C.36
2795170000	IE-PCB-SPE-P-180V2.1-THR RL	C.36

## 2810000000

2811930000	VPU II 1 R 1000V/40KA AC	A.29
2814180000	PVHYW-XXW-XX06W+15	E.23
2814190000	PVHYW-XXW-XX06W+15	E.23
2814200000	PVHYM-XXW-XX06M+11	E.23
2814210000	PVHYM-XXW-XX06M+11	E.23
2814220000	PVHYW-XXW-XX06W+15	E.23
2814240000	PVHXW-W+W-XX06W+15	E.23
2814250000	PVHXW-W+W-XX06W+15	E.23
2814260000	PVHXM-M+W-XX06M+11	E.23
2814270000	PVHXM-M+W-XX06M+11	E.23
2814280000	PVHXW-W+W-XX06W+15	E.23
2814290000	PVHXW-W+W-XX06W+15	E.23
2819550000	RC D/4/4P	A.24

## 2820000000

2820090000	PC RC M	A.25
------------	---------	------

## 2800000000

2826800000	UR20-1COM-232-485-422-V2	D.36
2826800000*	UR20-1COM-232-485-422-V2	C.47

## 2820000000

2827090000*	FC10 TN/26A S1 B BX	C.37
2827940000	FUSEHOLDER WFSH 10X38 1KV	E.23
2828540000	IE-SW-ELB-05-STX	D.34

## 2830000000

2833850000	PC RC F	A.25
2838400000	PRO BAS 30W 5V 6A	A.37
2838410000	PRO BAS 60W 24V 2.5A	A.37
2838420000	PRO BAS 60W 12V 5.8A	A.37
2838430000	PRO BAS 90W 24V 3.8A	A.37
2838440000	PRO BAS 120W 24V 5A	A.37
2838450000	PRO BAS 120W 12V 10A	A.37
2838460000	PRO BAS 240W 24V 10A	A.37
2838470000	PRO BAS 240W 48V 5A	A.37
2838480000	PRO BAS 480W 24V 20A	A.37

Order No.	Type	Page
2838490000	PRO BAS 480W 48V 10A	A.37
2838500000	PRO BAS 30W 24V 1.3A	A.37
2838510000	PRO BAS 30W 12V 2.6A	A.37
2838520000	AMG ELM-18 EX	D.29
2839150000	UC20-M3000	D.35
2839150000	UC20-M3000	E.13
2839150000*	UC20-M3000	C.48
2839160000	UC20-M4000	D.35
2839160000*	UC20-M4000	C.48

## 2840000000

2847200000	AL2C 2.5	D.20
------------	----------	------

## 2850000000

2853270000	APG 80	C.24
2853270000	APG 80	C.25
2853270000	APG 80	C.26
2853270000	APG 80	C.28
2854120000	RESMA-PLC-CONNECTOR	F.7
2854870000	RESMA-MODBUS-CONNECTOR	F.7
2855800000	TRP 24VDC ICO AGSNO PB	C.38
2855830000	TRP 24VDC ICO AGSNO AU PB	C.38
2855860000	TRS 24VDC ICO AGSNO AU PB	C.38
2855870000	TRS 24VDC ICO AGSNO PB	C.38
2855910000	TRP 24-230VUC ICO AGSNO ED2 PB	C.38
2857420000	PWEB-SCADA-RT-500/2	F.16
2857430000	PWEB-SCADA-RT-500/5	F.16
2857470000	PWEB-SCADA-RT-500/10	F.16
2857480000	PWEB-SCADA-RT-1000/2	F.16
2857520000	PWEB-SCADA-RT-1000/5	F.16
2857540000	PWEB-SCADA-RT-2000/2	F.16
2857550000	PWEB-SCADA-RT-2000/5	F.16
2857560000	PWEB-SCADA-RT-2000/10	F.16
2857570000	PWEB-SCADA-RT-5000/2	F.16
2857580000	PWEB-SCADA-RT-5000/5	F.16
2857600000	PWEB-SCADA-RT-5000/10	F.16
2857610000	PWEB-SCADA-RT-10000/2	F.16
2857620000	PWEB-SCADA-RT-10000/5	F.16
2857630000	PWEB-SCADA-RT-10000/10	F.16
2857650000	PWEB-DESIGNER-PRO	F.12
2857650000	PWEB-DESIGNER-PRO	F.16
2859340000	VPU AC I F 1 R 275/25	D.30
2859800000	AMG ELM-18	C.45
2859800000	AMG ELM-18	D.29

## 2860000000

2860020000	FSKIT 24VDC 5NO1NC FG LD AGSNO AU	D.27
2860560000	AWPD 35 4X6/6X2.5 BL	E.17
2860570000	AWPD 35 4X10 BL	E.17
2860640000	RC F P2 M20 SP	A.20
2860650000	RC M P2 M20 SP	A.20
2861190000	FRS TWC M30 MC 25	A.15
2861190000	FRS TWC M30 MC 25	A.16
2862170000	PWEB-SCADA-RT-30000/2	F.16
2862180000	PWEB-SCADA-RT-30000/5	F.16
2862190000	PWEB-SCADA-RT-30000/10	F.16
2862200000	PWEB-SCADA-RT-60000/2	F.16
2862210000	PWEB-SCADA-RT-60000/5	F.16
2862220000	PWEB-SCADA-RT-60000/10	F.16

## 2870000000

2870090000	U-LINK-50-DEVICES-1Y	A.49
2870090000	U-LINK-50-DEVICES-1Y	C.46
2870090000	U-LINK-50-DEVICES-1Y	D.34
2870130000	U-LINK-I-COMNECTION-1Y	A.49
2873880000	FUSE WSFL 2X258 30A 1K5V GPV	E.23
2873910000	IE-SR-4GT	A.49
2873920000	IE-SR-4GT-LTE/4G-EU	A.49
2873930000	IE-SR-4GT-LTE/4G-USEMEA	A.49
2873930000	IE-SR-4GT-LTE/4G-USEMEA	D.34
2874820000	S2C 4	C.34
2874820000	S2C 4	D.20
2874820000	S2C 4	E.16
2874840000	S3C 4	C.34
2874840000	S3C 4	D.20
2874840000	S3C 4	E.16
2874860000	S4C 4	C.34
2874860000	S4C 4	D.20
2874860000	S4C 4	E.16
2874900000	S4C 4 PE	C.34
2875320000	PWEB-ES-RT-5000/2	F.12
2875330000	PWEB-ES-RT-500	

Order No.	Type	Page
2992850000	PWEB-ES-RT-1000/5	F.12
2992860000	PWEB-ES-RT-2000/10	F.12
2992870000	PWEB-ES-RT-2000/2	F.12
2992880000	PWEB-ES-RT-2000/5	F.12
2992890000	PWEB-ES-RT-50/10	F.12
2992900000	PWEB-ES-RT-50/2	F.12
2992910000	PWEB-ES-RT-50/5	F.12
2992920000	PWEB-ES-RT-500/10	F.12
2992930000	PWEB-ES-RT-500/2	F.12
2992940000	PWEB-ES-RT-500/5	F.12
2992960000	RC M P3 C SP	A.21
2992970000	RC F P3 C SP	A.21
2992980000	RC M P3 M20 C SP	A.21
2992990000	RC F P3 M20 C SP	A.21
2995040000	WBC-P-8BK-70	C.24
2995050000	WBC-P-8OR-70	C.25
2997580000	PWEB-SCADA-RT-1000/10	F.16

## 3000000000

3001190000	HDC HE 6 FP EXI	D.22
3001200000	HDC HE 6 MP EXI	D.22
3001220000	HDC HE 10 FP EXI	D.22
3001230000	HDC HE 10 MP EXI	D.22
3001240000	HDC HE 16 FP EXI	D.22
3001250000	HDC HE 16 MP EXI	D.22
3001270000	HDC HE 24 FP EXI	D.22
3001280000	HDC HE 24 MP EXI	D.22
3001300000	HDC 06B ALU EXI	D.22
3001310000	HDC 10B ABU EXI	D.22
3001320000	HDC 16B ABU EXI	D.22
3001330000	HDC 24B ABU EXI	D.22
3001350000	HDC 06B TSLU 1M20G EXI	D.22
3001360000	HDC 06B TOLU 1M20G EXI	D.22
3001370000	HDC 10B TSBU 1M25G EXI	D.22
3001390000	HDC 10B TOBU 1M25G EXI	D.22
3001400000	HDC 16B TSBU 1M25G EXI	D.22
3001440000	HDC 16B TOBU 1M25G EXI	D.22
3001460000	HDC 24B TSBU 1M25G EXI	D.22
3001520000	HDC 24B TOBU 1M25G EXI	D.22

## 3020000000

3029480000	RESMA-100-IMPORT	F.7
3029490000	RESMA-200-IMPORT	F.7
3029500000	RESMA-500-IMPORT	F.7
3029510000	RESMA-1000-IMPORT	F.7
3029520000	RESMA-3000-IMPORT	F.7
3029530000	RESMA-10000-IMPORT	F.7
3029540000	RESMA-100-RECIPE	F.7
3029550000	RESMA-200-RECIPE	F.7
3029560000	RESMA-500-RECIPE	F.7
3029570000	RESMA-1000-RECIPE	F.7
3029580000	RESMA-3000-RECIPE	F.7
3029610000	RESMA-200-REGRESSION	F.7
3029620000	RESMA-500-REGRESSION	F.7
3029630000	RESMA-1000-REGRESSION	F.7
3029640000	RESMA-3000-REGRESSION	F.7
3029650000	RESMA-10000-REGRESSION	F.7

## 3030000000

3036610000	RESMA-100	F.7
3036620000	RESMA-200	F.7
3036630000	RESMA-500	F.7
3036640000	RESMA-1000	F.7
3036650000	RESMA-3000	F.7
3036660000	RESMA-10000	F.7
3036670000	RESMA-100-PRD	F.7
3036690000	RESMA-200-PRD	F.7
3036700000	RESMA-500-PRD	F.7
3036710000	RESMA-1000-PRD	F.7
3036720000	RESMA-3000-PRD	F.7
3036750000	RESMA-100-ENMS	F.7
3036760000	RESMA-200-ENMS	F.7
3036770000	RESMA-500-ENMS	F.7
3036780000	RESMA-1000-ENMS	F.7
3036790000	RESMA-3000-ENMS	F.7
3036800000	RESMA-10000-ENMS	F.7
3036850000	RC F P5 M20 C	A.23
3036860000	RC M P5 M20 C	A.23
3037270000	PWEB-ES-DESIGNER-2000_FREE	F.12
3037270000	PWEB-ES-DESIGNER-2000_FREE	F.16
3037270000	PWEB-ES-DESIGNER-2000_FREE	F.12
3037380000	SL2C 6	E.16
3037410000	SL3C 6	E.16
3037440000	SL4C 6	E.16
3037500000	SL2C 10	E.16
3038630000	U-OS-PWEB-ES-RT-250/2	F.12
3039320000	UR20-15AU-16-DIAG	D.36

## 3050000000

3052430000	CR120024	E.21
3052510000	CR120024T	E.21
3052570000	CSI P 2CD	E.21
3052590000	CSI S 2CD	E.21
3052710000	CXI CLIP P	E.21
3052940000	CRM40024	E.21

Order No.	Type	Page
3053010000	CRM40024T	E.21
3053140000	CSM P 4CD	E.21
3053160000	CSM S 4CD	E.21
3053240000	CXM CLIP P	E.21
3053900000	P-COM RUN	F.9
3053910000	P-COM DRV CODESYS	F.9
3053920000	P-COM DRV ALLENBRADLEY	F.9
3053930000	P-COM COM 50	F.9
3053940000	P-COM COM 100	F.9
3053950000	P-COM COM 250	F.9
3053960000	P-COM COM 500	F.9
3053970000	P-COM COM 1000	F.9
3053980000	P-COM COM 2500	F.9
3053990000	P-COM COM 5000	F.9
3054000000	P-COM COM 10000	F.9

## 3070000000

3072570000	WBC-CH-10RE-BK-95-0032	C.30
------------	------------------------	------

## 3100000000

3103570000	HDC HQ DC-LOCKLEV 3	E.19
3107540000	SLA Update (ResMa)	F.7

## 3110000000

3118160000	RESMA-1000-PRD	F.7
3118170000	RESMA-10000-REZPTUR	F.7
3118180000	RESMA-100-REGRESSION	F.7

## 3130000000

3136610000*	VPU DC II 3 R 500/40	E.20
3136620000*	VPU DC II 3 R 1000/40	E.20
3136630000*	VPU DC II 3 R 1500/40	E.20
3136640000*	VPU DC II EV 3 R 1000/40	E.20
3136910000	RC M P4 M20	A.22
3136920000	RC F P4 M20	A.22
3136930000	RC M P4	A.22
3136940000	RC F P4	A.22

## 4000000000

4000002597	FUSE WSFL 10X85 15A 1K5V GPV	E.23
4000002613	FUSEHOLDER WSFH 10X85 1K5V	E.23
4000003740	FUSEHOLDER WSFH 22X58 1K5V 80A	E.23

## 7760000000

7760051003	EM122-RTU-2P	D.37
7760051006	EM220-RTU-4DI2DO-GW	D.37
7760054188	ACT20P-TCI-2AD-P	D.25
7760054353	ACT20P-CI-1CO-OLP-P	D.25
7760054358	ACT20P-VMR-1PH-H-P	D.25
7760054360	ACT20P-VM-AO-P	D.25
7760054360	ACT20P-VM-AO-P	E.13
7760054360	ACT20P-VM-AO-P	E.14
7760056082	DRM570220	D.26
7760056097	DRM570024LT	D.26
7760056322	DRI424024	D.26
7760056340	DRI424024LTD	D.26
7760056362	SCM 2CO P	D.26
7760056363	SCM 4CO P	D.26
7760056364	SDI 1CO P	D.26
7760056365	SDI 2CO P	D.26

## 7910000000

7910180000	WTR 4	C.35
------------	-------	------

## 7940000000

7940045760	ACT20P-UJ-2RCD-DC-S	D.25
------------	---------------------	------

## 8000000000

8000098970	PVC DC 2I 10 2MPP RD SPD1R EVO 11	E.22
8000110028	ACT20C-8AI-MRTU-DC-S	D.25
8000140763	HDC KABELADAPTION 80.POL	D.19
8000140773	CONDITION MONITORING BDX IO 100EX	D.19
8000140778	CVM IO 160 HDC	D.18
8000142794	CVM PLC 100 CABTITE PSU 24V	D.18

## 8710000000

8713910000	MCZ R 48...110VDC 1CO TRAK	A.33
------------	----------------------------	------

## 8790000000

8790500000	MCZ R 48...110VDC 1CO AU TRAK	A.33
------------	-------------------------------	------

## 8940000000

8946920000	IE-TO-RJ45-C	C.46
8946920000	IE-TO-RJ45-C	D.34

Order No.	Type	Page
<b>8950000000</b>		
8951600000	VSPC 4SL 24VAC R	A.29
8951640000	VSPC 2SL 24VAC R	A.29
8951670000	VSPC RS485 2CH R	D.31
8951700000	VSPC 2CL HF 24VDC R	D.31
8951720000	VSPC BASE 2CL FG R	D.31
8951760000	VSPC BASE 4SL FG R	A.29
8951780000	VSPC BASE 2SL FG R	A.29
8951820000	VSPC BASE 2CL FG EX	D.31
8951840000	VSPC BASE 4SL FG EX	D.31
8953720000	VSPC 2CL 24VDC EX	D.31
<b>8970000000</b>		
8972270000	VSPC CONTROL UNIT 24VDC	D.31

## 9910000000

9918870000	VT DIGI PRO	E.12
------------	-------------	------

## 3100000000

3107950300	SAIL-M12G-2-X.XUBL	D.21
3107960300	SAIL-M12W-2-X.XUBL	D.21
3107980300	SAIL-M12G-5-X.XUBL	D.21
3107990500	SAIL-M12W-5-X.XUBL	D.21
3108010300	SAIL-M12G-2SDX.XUBL	D.21
3108020300	SAIL-M12W-2SDX.XUBL	D.21
3108030300	SAIL-M12G-4SDX.XUBL	D.21
3108040300	SAIL-M12W-4SDX.XUBL	D.21

We cannot guarantee that there are no mistakes in the publications or software provided by us to the customer for the purpose of making orders. We try our best to quickly correct errors in our printed media.

All orders are based on our general terms of delivery, which can be reviewed on the websites of our group companies where you place your order. On demand we can also send the general terms of delivery to you.

---

**Imprint:** Weidmüller Interface GmbH & Co. KG, Klingenbergstraße 26, 32756 Detmold, Tel.: +49 5231 14280, E-Mail: [weidmueller@weidmueller.de](mailto:weidmueller@weidmueller.de), [www.weidmueller.de](http://www.weidmueller.de) | Limited partnership (KG), Registered office: Detmold, Register court Lemgo HRA 2790 | General partner: Weidmüller Führungsgesellschaft mbH, Registered office: Detmold, Register court Lemgo HRB 3924, VAT ID no.: DE124599660 | Corporate Executive Management: Dr. Sebastian Durst, Dr. Timo Berger, André Sombecki, Dr. Christian von Toll



Weidmüller – Your partner in Smart Industrial Connectivity

As experienced experts we support our customers and partners around the world with products, solutions and services in the industrial environment of power, signal and data. We are at home in their industries and markets and know the technological challenges of tomorrow. We are therefore continuously developing innovative, sustainable and useful solutions for their individual needs. Together we set standards in Smart Industrial Connectivity.

**Weidmüller** 