

Milwaukee[®]

Nothing but **HEAVY DUTY.**[™]



2025/26

TO DEVELOP AND PRODUCE **NOTHING BUT HEAVY DUTY™ POWER TOOLS** IS ONLY ONE PART OF THE **MILWAUKEE® PROMISE.**

These tools need to last day in and day out. For this reason, serviceability is incorporated into every tool produced.

All power tools leave the factory with a complete documentation package including instructions for use, listing of customer service centres and safety instructions. MILWAUKEE® has a worldwide service network.

Should a problem arise requiring assistance or support at short notice, you can rely on our service centres/agents worldwide.

The global network ensures that our customers' needs and requirements are shared to influence future product development.

Expertise and competence gained over many years ensures a fast and efficient professional repair service.



MILWAUKEE® strive to meet and surpass all international and European standards and directives for both design and safety. Constant research and development programs aim to anticipate and fulfil future market trends in all regulatory and efficiency requirements. MILWAUKEE® is, amongst others, an active member of EPTA (European Power Tool Association) and so is proudly aligned to all industry measurement standards agreed by the organisation.

EXPERIENCE THE HEAVY DUTY DIFFERENCE

TOOLS BUILT TO DO THE JOB BETTER.

At MILWAUKEE® Heavy Duty is more than just a slogan. It is a promise to offer the best to professional users. Engineers at MILWAUKEE® don't just design tools.

They design tools to get the job done better, faster, reliably and safely.

www.milwaukeetool.eu



ALL YOU HAVE TO DO TO TAKE ADVANTAGE OF OUR EXTRA GUARANTEE OFFER IS TO REGISTER ONLINE. NOTHING BUT HEAVY DUTY™

NOTHING BUT HEAVY DUTY GUARANTEE:



*From 1st of February 2024 the extended guarantee for eligible MILWAUKEE® power tool(s), outdoor power equipment and REDLITHIUM™ batteries will only be granted if the product is new and purchased via an Authorised MILWAUKEE® Distributor. The same applies to the guarantee for MILWAUKEE® hand tool(s) as well. Rights already established before 1st of February 2024 shall remain unaffected.



For full terms and conditions for each of the above mentioned guarantees, please see the link below;
<https://www.milwaukeetool.eu/service/>



MILWAUKEE® power tool(s), outdoor power equipment & batteries come with a standard 1 year guarantee. Guarantee extensions are available by visiting www.milwaukeetool.eu.

MILWAUKEE® power tool(s) and outdoor power equipment guarantee can be extended from 1 year to a maximum of 3 years (1 + 2). With the exception of MX FUEL™ tools for which the guarantee can be extended from 1 year to a maximum of 2 years (1 + 1).

All MILWAUKEE® REDLITHIUM™ batteries including MX FUEL™ batteries come with a standard 1 year guarantee which can be extended to a maximum of 2 years (1 + 1).

All guarantee extensions are subject to registering online within 30 days of the purchase date.

Every MILWAUKEE® is tested according to a comprehensive certified process before leaving the factory and is guaranteed to

be **NOTHING BUT HEAVY DUTY™** qualified. At MILWAUKEE® we take great pride in the products and services we offer to our professional customers.

The guarantee extension is only available in those countries listed on our warranty registration website. The extended guarantee offer excludes products used in the hire industry, battery chargers and accessories supplied.

MILWAUKEE® hand tool lifetime guarantee

Certain MILWAUKEE® hand tools come with a lifetime guarantee which means they can be replaced or repaired free of charge should they break during normal usage due to material or manufacturing fault.*

MILWAUKEE® Levels - 30 year accuracy guarantee

The following MILWAUKEE® levels are sold with a 30 year accuracy guarantee: MILWAUKEE® BACKBONE™; Compact box levels; and the Block Torpedo level.*

MILWAUKEE® Levels - 10 year accuracy guarantee

The following MILWAUKEE® levels are sold with a 10 year accuracy guarantee: MILWAUKEE® Slim box level; REDCAST™ level; Minibox level; Billet Torpedo; and I-Beam level.*

*For full terms and conditions for each of the above mentioned guarantees, please see the link below;
<https://www.milwaukeetool.eu/service/>

ZERO EMISSIONS IN USE.* ZERO COMPROMISE.

ENSURING OUR USERS CAN WORK SAFELY,
SUSTAINABLY, AND PRODUCTIVELY.

THE EU AIMS TO BE CLIMATE-NEUTRAL BY 2050**



**PETROL
EQUIVALENT
PERFORMANCE**



**LOW
NOISE**



**NO PETROL
OR EMISSIONS**



**LESS
DOWNTIME**



**ENHANCED
JOBSITE SAFETY**



**INCREASED
PRODUCTIVITY**

*Zero emissions when product in use

** Information sourced from European commission press release, available: Making the EU climate-neutral by 2050 (europa.eu)



ZERO
EMISSIONS IN USE

MXF PC50 MX FUEL™ PLATE COMPACTOR



ONE KEY
UNLOCKING THE DIGITAL JOBSITE.



- First reversible Plate Compactor of the weight class
- High speed of 26 m/min without sacrificing compaction force
- 2 speed modes deliver ultimate user control and required pace for more efficiency
- Accessible push-button controls on handle
- Easy flip handle for direction changes
- Foldable handle for easy transportation and efficient storage on site

MXF PC50-0

MXF PC50-122

Kit included	No batteries supplied, No charger supplied, No kitbox or bag supplied	2 x MXF HD812 Battery packs, MXF SC Charger, No kitbox or bag supplied
Article Number	4933493267	4933493268
EAN Code	4058546481384	4058546481391

**SEE PAGE 105 OR SCAN
TO VIEW OUR SYSTEM
ATTACHMENTS FOR PLATE
COMPACTOR**



MXF RAM MX FUEL™ RAMMER



ONE KEY
UNLOCKING THE DIGITAL JOBSITE.



- No petrol headaches in trenches
- Petrol-like performance
- Handle integrated controls for increased user safety
- 2 speed modes deliver ultimate user control and required pace for more efficiency
- Accessible push-button controls on handle
- Fuel gauge displays remaining charge

MXF RAM60-0

MXF RAM60-122

Kit included	No batteries supplied, No charger supplied, No kitbox or bag supplied	2 x MXF HD812 Battery packs, MXF SC Charger, No kitbox or bag supplied
Article Number	4933498158	4933498159
EAN Code	4058546513184	4058546513191



MXF CVHF MX FUEL™ HIGH FREQUENCY CONCRETE VIBRATOR



- The MX FUEL™ High Frequency Concrete Vibrator is the ideal solution when working on larger areas, delivering AC like performance without the hassle of laying cables or having the need for an AC socket on the job site
- Consolidates up to 55 m³ of concrete on 1x MXF XC608 battery

	MXF CVHF-0	MXF CVHF-802
Kit included	No batteries supplied, No charger supplied, No kitbox or bag supplied	2 x MXF XC608 Battery packs, MXF SC Charger, No kitbox or bag supplied
Article Number	4933498132	4933498133
EAN Code	4058546512927	4058546512934

MXF CVBC MX FUEL™ BRIEFCASE CONCRETE VIBRATOR



- Compact and slim design for increased mobility suiting stationary as well as mobile applications
- Carrying strap and handle for increased flexibility on site and easy transport
- Equipped with a ring for easy attachment of the vibrator to the scaffolding or the formwork

	MXF CVBC-0	MXF CVBC-602	MXF CVBCKIT-602
Standard equipment	Remote control	Remote control	Remote control, 4 m vibrator shaft, 38 mm vibrator head
Kit included	No batteries supplied, No charger supplied, No kitbox or bag supplied	2 x MXF XC406 Battery packs, MXF C Charger, No kitbox or bag supplied	2 x MXF XC406 Battery packs, MXF C Charger, No kitbox or bag supplied
Article Number	4933479607	4933479608	4933479610
EAN Code	4058546374013	4058546374020	4058546374044

MXF PSC MX FUEL™ SCREED



- The MX FUEL™ Screed is the ideal solution when working on larger areas, delivering petrol like performance without petrol headaches
- Power to pull blades up to 4.9 m
- The push-button start delivers instant power, eliminating the repetitive motions of a pull start and reducing downtime, allowing you to get jobs done faster without sacrificing the power and run time you expect

	MXF PSC-0	MXF PSC-302
Kit included	No batteries supplied, No charger supplied, No kitbox or bag supplied	2 x MXF CP203 Battery packs, MXF C Charger, No kitbox or bag supplied
Article Number	4933479771	4933479772
EAN Code	4058546375652	4058546375669

MXF WBT90 MX FUEL™ 900 MM WALK BEHIND POWER TROWEL



- Provides a smooth, balanced finishing experience with 5 HP performance
- AUTOSTOP™ for improved user protection
- Up to 25 min run time per charge
- Variable blade, max blade speed up to 130 rpm
- Ergonomic throttle for best control
- Handlebar height adjustment for increased comfort
- Fine pitch dial for precise blade pitch adjustment

	MXF WBT90-0	MXF WBT90-122
Standard equipment	1x set of combination blades (4pcs)	1x set of combination blades (4pcs)
Kit included	No batteries supplied, No charger supplied, No kitbox or bag supplied	2 x MXF HD812 Battery packs, MXF SC Charger, No kitbox or bag supplied
Article Number	4933498326	4933493602
EAN Code	4058546521950	4058546484736

MXF CVBP MX FUEL™ BACKPACK CONCRETE VIBRATOR



- The MX FUEL™ Backpack Concrete Vibrator is the ideal solution when working on larger areas, delivering AC like performance without the hassle of laying cables or having the need for an AC socket on the jobsite
- It has the power to push up to Ø63 mm head at over 11,200 VPM for optimal consolidation, even in the stiffest concrete

	MXF CVBP-0	MXF CVBP-602	MXF CVBPKIT-602
Standard equipment	Remote control	Remote control	Remote control, 2 m vibrator shaft, 38 mm vibrator head
Kit included	No batteries supplied, No charger supplied, No kitbox or bag supplied	2 x MXF XC406 Battery packs, MXF C Charger, No kitbox or bag supplied	2 x MXF XC406 Battery packs, MXF C Charger, No kitbox or bag supplied
Article Number	4933479595	4933479591	4933479593
EAN Code	4058546373894	4058546373856	4058546373870

SEE PAGE 104 OR SCAN TO VIEW OUR ACCESSORIES FOR CONCRETE VIBRATORS



MXF WBT60 MX FUEL™ 600 MM WALK BEHIND EDGING TROWEL



- Provides a smooth, balanced finishing experience with 5 HP performance
- AUTOSTOP™ for improved user protection
- Up to 35 min run time per charge
- Variable blade speed from 30 to 160 rpm
- Ergonomic throttle for best control
- Handlebar height adjustment for increased comfort
- Fine pitch dial for precise blade pitch adjustment

	MXF WBT60-0	MXF WBT60-122
Standard equipment	1x set of combination blades (4pcs)	1x set of combination blades (4pcs)
Kit included	No batteries supplied, No charger supplied, No kitbox or bag supplied	2 x MXF HD812 Battery packs, MXF SC Charger, No kitbox or bag supplied
Article Number	4933498325	4933493601
EAN Code	4058546521943	4058546484729

MXF SMP2 MX FUEL™ SUBMERSIBLE PUMP



- 3-mode operation for the perfect flow rate
- Eco-mode for extended run time
- Auto-sensing: On, Off, Automated flow rate
- Up to 18 m pump height
- 320 l/min flow rate for optimised productivity
- User notifications via remote control
- No more generators when using indoors or under ground

	MXF SMP2-0	MXF SMP2-802
Kit included	No batteries supplied, No charger supplied, No kitbox or bag supplied	2 x MXF XC608 Battery packs, MXF FC Charger, No kitbox or bag supplied
Article Number	4933498162	4933498163
EAN Code	4058546513221	4058546513238

MXF COS350G2 MX FUEL™ 350 MM CUT-OFF SAW



ONE KEY
UNLOCKING THE DIGITAL JOBSITE.



- Battery powered, it can be used indoors due to zero fume emissions
- Anti-kickback system prevents users from being injured in case of a kickback
- RAPIDSTOP™/ blade brake: blade stops within < 3 sec
- Petrol equivalent performance with a maximum no load speed of 5370 rpm and a full 125 mm depth of cut

MXF COS350G2-0

MXF COS350G2-802

Standard equipment	HUDD 350mm SPEEDCROSS™ diamond blade (4932471985) & contractor bag	HUDD 350mm SPEEDCROSS™ diamond blade (4932471985) & contractor bag
Kit included	No batteries supplied, No charger supplied, Contractor Bag	2 x MXF XC608 Battery packs, MXF SC Charger, Contractor Bag
Article Number	4933480478	4933480480
EAN Code	4058546407636	4058546407650



MXF COSCG2 MX FUEL™ CUT-OFF SAW CART



- 350 mm cut-off saw cart to maintain straight cuts with full 125 mm depth of cut capacity
- Height-adjustable drive handle and easy to reach depth adjustment handle to facilitate one-handed operation
- Tool-free machine and water tank attachment compatible with the M18™ SWITCH TANK™ interchangeable sprayer and water supply system

MXF COSCG2

Article Number	4933493264
EAN Code	4058546481353

SCAN TO VIEW OUR CUT-OFF SAW DISCS



MXF DCD350 MX FUEL™ 350 MM DIAMOND CORE DRILL



ONE KEY
UNLOCKING THE DIGITAL JOBSITE.



- Rig-mounted diamond coring up to 350 mm diameter. Core with confidence by delivering AC performance
- 4 speed gearing for a wide range of applications, with laser etched speed and capacity markings into the metal body
- Speed 1: 152 - 350 mm/ Speed 2: 76 - 152 mm/ Speed 3: 51 - 76 mm/ Speed 4: up to 51 mm

MXF DCD350 KIT-0

MXF DCD350 KIT-122

Standard equipment	MXF DCD350 DR rig stand	MXF DCD350 DR rig stand
Kit included	No batteries supplied, No charger supplied, No kitbox or bag supplied	2 x MXF HD812 Battery packs, MXF SC Charger, No kitbox or bag supplied
Article Number	4933493142	4933493143
EAN Code	4058546480134	4058546480141

MXF DCD150 MX FUEL™ 150 MM DIAMOND CORE DRILL



ONE KEY
UNLOCKING THE DIGITAL JOBSITE.



- Core with confidence by delivering AC performance with a maximum core diameter capacity of 152 mm wet & dry
- 2 speed gearing for a wide range of applications, with laser etched speed and capacity markings into the metal body
- Speed 1: up to 75 mm diameter wet & dry coring at 1600 rpm
- Speed 2: 76 to 152 mm diameter wet & dry coring 800 rpm

MXF DCD150-0C

MXF DCD150-302C

MXF DCD150-302C KIT

Standard equipment	Trigger lock-on, side handle	Trigger lock-on, side handle	Trigger lock-on, side handle, MXF DR255TV drill stand
Kit included	No batteries supplied, No charger supplied, Kitbox	2 x MXF CP203 Battery packs, MXF C Charger, Kitbox	2 x MXF CP203 Battery packs, MXF C Charger, Kitbox
Article Number	4933478986	4933464887	4933471835
EAN Code	4058546362683	4058546228323	4058546297343

MXF DR255TV PREMIUM DIAMOND DRILLING STAND FOR MX FUEL™ DIAMOND CORE DRILL MXF DCD150



- Height-adjustable insulated drive handle and easy to reach depth adjustment handle to facilitate one-handed operation
- Universal hinged motor clamp with 60 mm collar diameter
- Tool-free machine and watertank attachment compatible with M18™ SWITCH TANK™ 15 l water supply

MXF DR255TV

Article Number	4933472247
EAN Code	4058546338930

SEE PAGE 109 OR SCAN TO VIEW OUR SYSTEM ATTACHMENTS FOR MX FUEL™ DIAMOND CORE DRILLS



MXF DH2528H
MX FUEL™ 25 KG CLASS 28 MM HEX DEMOLITION
HAMMER



- The industry's first cordless 28 mm Hex demolition hammer, delivering the power of petrol, corded and pneumatic
- Heavy Duty hammer provides 64 blow Joules of impact energy for toughest demolition applications
- Floating body anti-vibration technologies allows the user to work all day without reaching dangerous exposure levels

	MXF DH2528H-0	MXF DH2528H-602
Kit included	No batteries supplied, No charger supplied, No kitbox or bag supplied	2 x MXF XC406 Battery packs, MXF C Charger, No kitbox or bag supplied
Article Number	4933478985	4933464877
EAN Code	4058546362676	4058546228224

MXF DHT
BREAKER TROLLEY FOR MX FUEL™ DEMOLITION
HAMMER



- Lightweight demolition hammer cart with large rubber wheels for easy transport across uneven terrain
- Integrated demolition hammer retention strap and full-metal fastening locations
- On-board spring-loaded storage locations for 4 chisels
- Battery & charger storage dock with charger cable hook for transport

	MXF DHT
Article Number	4933464879
EAN Code	4058546228248

MXF PTR2
MX FUEL™ PIPE THREADING MACHINE 2"



- Threading capacity from 1/8" all the way up to 2"
- One stop shop: Cut, Ream and Thread with one tool
- Outstanding performance with 2 speed settings of 39 RPM and 59 RPM matching corded speed
- Maximum mobility thanks to foldable wheel cart with tool free setup
- Integrated auto oil system with oil pump and reservoir

	MXF PTR2-0	MXF PTR2-601
Standard equipment	1/2"-3/4" BSPT HS die set, 1"-2" BSPT HS die set	1/2"-3/4" BSPT HS die set, 1"-2" BSPT HS die set
Kit included	No batteries supplied, No charger supplied, No kitbox or bag supplied	1 x MXF XC406 Battery pack, MXF C Charger, No kitbox or bag supplied
Article Number	4933498324	4933492100
EAN Code	4058546521936	4058546414672

SEE PAGES 106 - 107 OR
SCAN TO VIEW OUR SYSTEM
ATTACHMENTS FOR MX FUEL™
PIPE THREADING MACHINE 2"
WITH ONE-KEY™



MXF LSDP
MX FUEL™ LARGE SEWER DRUM MACHINE WITH
POWERTREDZ™



- The MX FUEL™ large sewer drum machine with integrated POWERTREDZ™, requires one person only to move the sewer machine in and out of the service van, up and down building stairs
- World's first battery powered large drum machine that uses MILWAUKEE® 16 mm and 20 mm inner core spirals in drains from 75 mm up to 200 mm, with the power to clear roots up to 60 m down the line

	MXF LSDP-301
Standard equipment	1 x 20 mm x 15.2 m inner core cable, 1 x 20 mm x 7.6 m inner core cable, 1 x 9 pc head attachment kit
Kit included	1 x MXF CP203 Battery pack, MXF C Charger, No kitbox or bag supplied
Article Number	4933471851
EAN Code	4058546297503

SEE PAGE 110 OR SCAN
TO VIEW OUR SYSTEM
ATTACHMENTS FOR MX FUEL™
LARGE SEWER DRUM
MACHINE WITH POWERTREDZ™



MXF TL
MX FUEL™ TOWER LIGHT



TRUEVIEW™

- TRUEVIEW™ high definition light output with up to 27,000 lumens in AC and up to 20,000 lumens in DC mode for both task and area lighting
- Has the ability to manoeuvre the light heads in multiple orientations, allowing the user to direct light to wherever it's needed

	MXF TL-601
Kit included	1 x MXF XC406 Battery pack, Integrated charger, No kitbox or bag supplied
Article Number	4933471844
EAN Code	4058546297435

MXF TLIC
MX FUEL™ COMPACT SITE LIGHT



TRUEVIEW™



- TRUEVIEW™ high definition light output with up to 15,000 lumens in AC and DC mode for both task and area lighting
- Has the ability to manoeuvre the light head, allowing the user to direct light to wherever it's needed
- Low weight of 17.5 kg without battery allows for easy transportation across wet and uneven job site terrains with minimum effort

	MXF TLIC-0	MXF TLIC-601
Kit included	No batteries supplied, No charger supplied, No kitbox or bag supplied	1 x MXF XC406 Battery pack, MXF C Charger, No kitbox or bag supplied
Article Number	4933498075	4933498072
EAN Code	4058546512354	4058546512323

MXF PS MX FUEL™ POWER SUPPLY



ONE KEY
UNLOCKING THE DIGITAL JOBSITE.



- Building on the strengths of the FUEL™ technology, MX FUEL™ system reaches new levels of cordless performance. Focused on petrol, corded and pneumatic performance, these tools deliver without the hazards associated with emissions, noise, vibration, tripping hazards and the frustrations of complex maintenance

MXF PS-0

MXF PS-602

Kit included	No batteries supplied, Integrated charger, No kitbox or bag supplied	2 x MXF XC406 Battery packs, Integrated charger, No kitbox or bag supplied
Article Number	4933493922	4933479266
EAN Code	4058546510824	4058546370602

MXF PBE MX FUEL™ PORTABLE BATTERY EXTENSION



- Reduces tool weight by up to 45% by adding the battery to the backpack harness
- Leverage XC & HD batteries on handheld equipment without ergonomic trade-off
- Maintains peak performance
- Up to 2X more run time with MX FUEL™ REDLITHIUM™ FORGE™ batteries
- Detachable backpack harness
- Folding handle for easy carrying or hanging
- Fits all MX FUEL™ battery packs

MXF PBE-0

Kit included	No batteries supplied, No charger supplied, No kitbox or bag supplied
Article Number	4933498067
EAN Code	4058546512279

IRPSUOP2500 ROLL-ON 7200/ 3600 W 2.5 KWH POWER SUPPLY

ONE KEY
UNLOCKING THE DIGITAL JOBSITE.



- REDLITHIUM™ 2.5 kWh internal battery with peak power of 7,200 W and continuous power of 3,600 W
- Wheels and telescoping handle providing portable power anywhere and job site ready
- IP54 rating
- Passthrough power for charging and discharging simultaneously
- Zero emissions, quiet operation, efficient power without downtime and no power wasted

IRPSUOP2500

Article Number	4933492133
EAN Code	4058546415006



REDLITHIUM™ FORGE™

MOST POWER | FASTEST CHARGING | LONGEST LIFE*

**UP TO 2X MORE
RUN TIME**

SIMILAR SIZE AND WEIGHT VS. XC406



**COOL-CYCLE™
CAPABLE**

HIGH SPEED COOLING



ACTIVE COOLING SYSTEM

**LONGEST
LIFE**

VS REDLITHIUM™



* Vs other cell technologies

MX FUEL™ BATTERIES



	MXF HD812	MXF XC608	MXF XC406	MXF XC-2406	MXF CP203	MXF CP-2203
System	MX FUEL™	MX FUEL™	MX FUEL™	MX FUEL™	MX FUEL™	MX FUEL™
Battery pack capacity (Ah)	12.0	8.0	6.0	6.0	3.0	3.0
No. of batteries supplied	1	1	1	2	1	2
Charge time MXF C charger	160 min	110 min	90 min	90 min	45 min	45 min
Charge time MXF FC charger	100 min	65 min	45 min	45 min	45 min	45 min
Charge time MXF SC charger	65 min	45 min	45 min	45 min	45 min	45 min
Weight (kg)	5.9	4.5	4.8	4.8	2.7	2.7
Supplied in	No kitbox or bag supplied	No kitbox or bag supplied	No kitbox or bag supplied	No kitbox or bag supplied	No kitbox or bag supplied	No kitbox or bag supplied
Article Number	4932492128	4932492130	4933471837	4933479162	4933471838	4933479161
EAN Code	4058546414955	4058546414979	4058546297367	4058546369569	4058546297374	4058546369552

MX FUEL™ CHARGERS



	MXF SC	MXF FC	MXF C
Charging ports	1 x MX FUEL™	1 x MX FUEL™	1 x MX FUEL™
Charge type	Single	Single	Single
Power source	AC	AC	AC
Carry handle	Yes	Yes	Yes
Wall mountable	No	Yes	Yes
Weight (kg)	8.9	2.33	2.7
Supplied in	No kitbox or bag supplied	No kitbox or bag supplied	No kitbox or bag supplied
Article Number	4932492848	4933498547	4933471839
EAN Code	4058546477196	4058546524166	4058546297381

MX FUEL™ BATTERIES AND CHARGER KITS







	MXF NRG-406	MXF FORGENRG-802	MXF FORGENRG-122
Kit included	2 x MXF XC406 Battery packs, MXF C Charger, No kitbox or bag supplied	2 x MXF XC608 Battery packs, MXF SC Charger, No kitbox or bag supplied	2 x MXF HD812 Battery packs, MXF SC Charger, No kitbox or bag supplied
Article Number	4933479160	4933493548	4933493549
EAN Code	4058546369545	4058546484194	4058546484200



**EQUIPMENT REDEFINED.
TRADE FOCUSED.
SYSTEM WIDE.**













THE MILWAUKEE® MX FUEL™ CORDLESS SYSTEM REVOLUTIONISES THE LIGHT EQUIPMENT MARKET BY DELIVERING THE PERFORMANCE, RUN TIME, AND DURABILITY DEMANDED BY THE TRADES WITHOUT THE HAZARDS ASSOCIATED WITH EMISSIONS, NOISE, VIBRATION, AND THE FRUSTRATIONS OF PETROL MAINTENANCE.

NOW WITH OVER 25 SOLUTIONS, THE MX FUEL™ EQUIPMENT SYSTEM PROVIDES EQUIVALENT PETROL, CORDED AND PNEUMATIC PERFORMANCE WHILE PRODUCING ZERO EMISSIONS IN USE.

		BATTERY	
TOOL	APPLICATION	MXF XC608  	MXF HD812  
MXF COS350G2	Cutting kerbstone	36 cuts*	50 cuts*
MXF DH2528H	Breaking concrete	1.3 tonnes*	4 tonnes*
MXF DCD150	76 mm x 250 mm holes	17 holes*	26 holes*
MXF DCD350	250 mm x 150 mm holes	3 holes*	5 holes*
MXF PS	Grinding with 180 mm corded angle grinder	40 min* [†]	60 min* [†]
MXF CVHF	Pouring concrete	55 m ³ *	82 m ³ *
MXF CVBP	Pouring concrete	53 m ³ *	80 m ³ *
MXF CVBC	Pouring concrete	53 m ³ *	80 m ³ *
MXF PSC	Screeding concrete	5 hours 20 min*	8 hours*
MXF WBT60	Finishing concrete	23 min*	35 min*
MXF WBT90	Finishing concrete	16 min*	25 min*
MXF PC50	Compacting gravel	22 min*	35 min*
MXF RAM	Compacting gravel	17 min*	25 min*
MXF SMP2	Pumping water (High Mode)	28 min*	40 min*
MXF PTR2	Full cycle	200 cycles*	280 cycles*
MXF TL	on High Mode	4 hours*	6 hours*
MXF TLIC	on High Mode	4 hours*	6 hours*

* Run times are based on a fully-charged battery. These given guidelines are indicative only and may not be replicated due to the varying usage conditions. Results can vary depending on the user and the application.



† Using 2 batteries during application.

COMPARE OUR CHARGERS		 MOST POWER FASTEST CHARGING LONGEST LIFE			
		  MXF HD812	  MXF XC608	 MXF XC406	 MXF CP203
 	MXF SC	65 min	45 min	45 min	45 min
 	MXF FC	100 min	65 min	45 min	45 min
 	MXF C	160 min	110 min	90 min	45 min

THE *EASIEST* WAY TO KEEP TRACK OF YOUR INVENTORY



ONE-KEY™
UNLOCKING THE DIGITAL JOBSITE.™

 Bluetooth  LOCATION

TRACK. MANAGE. CUSTOMISE.



With ONE-KEY™ you can add tools and equipment no matter the brand to your inventory and get a full overview of ALL your assets. Add unlimited users for free, assign tools to different employees and see which tools that are currently in use, ready for use or perhaps at the service centre.

Follow a digital trace of when, where and how your tools have been used to optimise efficiency and usage, or use it to track and lock your tools and equipment if it's missing.

Print professional reports and get documentation on the tool status and usage.

All of this and much more **FOR FREE!**



GET STARTED IN 2 MINUTES

STEP 1

**DOWNLOAD THE
MILWAUKEE®
ONE-KEY™ APP
FOR FREE**



STEP 2

**REGISTER
YOUR PROFILE
FAST & EASY**



STEP 3

**DONE!
YOU ARE NOW
READY TO USE
ONE-KEY™**



*The Bluetooth® word mark and logos are registered trademarks owned by Bluetooth SIG, Inc., and any use of such marks by (TTI corporate name) is under license. Other trademarks and trade names are those of their respective owners.



NEXT GENERATION

M18 FUEL™

DRIVEN TO OUTPERFORM.™

LIMITS REDEFINED.

M18 FUEL™ NEXT GENERATION. MORE COMPACT. UNRIVALLED ACCURACY. REDEFINED PERFORMANCE.

M18™ Next Generation FUEL™, packs a mighty punch in a smaller package. More compact, yet more powerful, the range is perfect for those hard to reach areas, and ideal for working at height, due to the reduced size and weight, better balance and easier handling.

Put M18™ Next Generation FUEL™ to the test, and reset your expectations of 18 V tools.



VIEW THE

NEXT GENERATION

1

POWERSTATE™ BRUSHLESS MOTOR



2

REDLINK PLUS™ INTELLIGENCE



3

REDLITHIUM™ BATTERY PACKS



MORE COMPACT.

UNRIVALED ACCURACY.

REDEFINED PERFORMANCE.

NEW

M18

REDLITHIUM™ FORGE™

MOST POWER | FASTEST CHARGING | LONGEST LIFE

WHAT MAKES REDLITHIUM™ FORGE™?

M18 REDLITHIUM FORGE™

NEW LITHIUM CELL TECHNOLOGIES



OLD TAB DESIGN



NEW TABLESS DESIGN

- ▶ Up to 50% higher power
- ▶ Up to 45% less heat generation
- ▶ Up to 6X faster charging
- ▶ Up to 50% lower electrical resistance

NEXT GENERATION ELECTRONICS



- ▶ Maximise full power delivery to tool
- ▶ Accelerate charge speed
- ▶ Full system backwards compatibility

MECHANICAL REDESIGN



- ▶ Advanced thermal management
- ▶ Vibration protection
- ▶ Built to withstand harsh jobsite environments
- ▶ Laser welding

ADVANCED PROTECTION



- ▶ Patented polymer ingress coating: protection against water and debris
- ▶ Resistant housing: protection against common oils, greases and solvents

* Vs other cell technologies



ACTIVE COOLING SYSTEM



WORK DONE WITH 80% CHARGE



Up to 18.5 cuts of 400 mm hard wood with 2x M18 FB12 (M18 F2CHS50)



Up to 553 cuts in 50 x 100 mm soft wood with M18 FB12 (M18 FCS66)

TIME TO COOL & CHARGE A HOT BATTERY

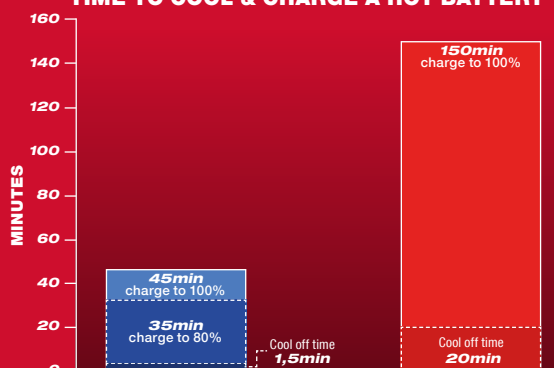

THREE BENEFITS OF COOL-CYCLE™ ACTIVE COOLING SYSTEM

COOL-CYCLE™ CAPABLE PACKS:

1. BEGIN CHARGING RAPIDLY
2. COME OFF THE CHARGER COOLER, RESULTING IN MORE WORK DONE PER DAY
3. HAVE LONGER LIFE



REDLITHIUM FORGE + COOL-CYCLE™



REDLITHIUM HIGH OUTPUT BATTERY PACK + RAPID CHARGER

* vs previous generation

UPGRADE YOUR TOOLS WITH FORGE™

SCAN HERE TO VIEW OUR FULL RANGE OF FORGE BATTERIES



H REDLITHIUM™
HIGH OUTPUT BATTERY TECHNOLOGY

VS

M18 REDLITHIUM™
FORGE™

MOST POWER | FASTEST CHARGING | LONGEST LIFE*



BATTERY RUN TIMES

TOOL DESCRIPTION	APPLICATION	H REDLITHIUM™ HIGH OUTPUT BATTERY TECHNOLOGY		M18 REDLITHIUM™ FORGE™		RESULTS PER BATTERY CHARGE
		M18 HB8	M18 HB12	M18 FB8	M18 FB12	
 M18 FCHS M18 FUEL™ CHAINSAW WITH 40 CM BAR	LOG CUTTING CUTTING OF 30 CM SPRUCE TREE		23 cuts*		36 cuts*	up to 56% increase*
 M18 F2CHS50 M18 FUEL™ 50 CM DUAL BATTERY CHAINSAW	LOG CUTTING CUTTING OF 35 CM SPRUCE TREE	23 cuts*†		32 cuts*†		up to 39% increase*
 M18 FTCHS35 M18 FUEL™ TOP HANDLE CHAINSAW WITH 35 CM BAR	LOG CUTTING CUTTING OF 30 CM SPRUCE TREE	12 cuts*		24 cuts*		up to 100% increase*
 M18 FLAG230XPDB M18 FUEL™ 230 MM LARGE BRAKING GRINDER WITH PADDLE SWITCH	METAL GRINDING MATERIAL REMOVAL FROM STEAM BEAM		147 g debris removal*		234 g debris removal*	up to 59% increase*
 M18 ONEFLAG230XPDB M18 FUEL™ ONE-KEY™ 230 MM BRAKING ANGLE GRINDER WITH PADDLE SWITCH	METAL GRINDING MATERIAL REMOVAL FROM STEAM BEAM		187 g debris removal*		223 g debris removal*	up to 19% increase*
 M18 FHSAG125XPDB M18 FUEL™ HIGH PERFORMANCE 125 MM BRAKING GRINDER WITH PADDLE SWITCH	PIPE CUTTING CUTTING OF 22 MM METAL PIPES		127 cuts*		175 cuts*	up to 38% increase*
 M18 FMCS66 M18 FUEL™ 66 MM METAL CIRCULAR SAW	METAL CUTTING CUTTING OF 3 MM SHEET METAL		22 metre cuts*		25 metre cuts*	up to 15% increase*
 M18 FCS66GR3 M18 FUEL™ GUIDE RAIN COMPATIBLE CIRCULAR SAW	LAMINATED CUTTING RIP CUT THROUGH 42 MM LAMINATED PINE 140 MM CUTS		28 cuts*		34 cuts*	up to 22% increase*
 M18 FCOS230 M18 FUEL™ CUT-OFF SAW	KERBSTONE CUTTING CUTTING OF 250 X 80 MM KERBSTONE		7 cuts*		11 cuts*	up to 46% increase*

*Runtimes are based on a fully-charged battery. These given guidelines are indicative only and may not be replicated due to the varying usage conditions. Results can vary depending on the user and the application. † Using 2 batteries.

GET THE RIGHT HAMMER FOR THE JOB

1 For the more demanding, heavy duty applications. Including dry coring and medium duty chipping in both concrete block and reinforced concrete



2 For heavy duty applications, ideal for plumbing or formwork



3 Excellent performance, ideal for repetitive and fast drilling



4 Balanced performance weight ratio, ideal for light chiseling applications



5 Fixing hammers, ideal for tight spaces and all day use



SDS-MAX

	Platform	Feature	ONE-KEY™	Blow energy (EPTA)(J)	Full load hammer action (bpm)	No load speed (rpm)	Optimised drilling capacity in concrete (mm)	Vibration drilling (m/s²)	Vibration chiseling (m/s²)	Weight with battery pack (EPTA) (kg)	Fits MILWAUKEE® Dust Extractors	
1.	M18 FHM-121C	M18 FUEL™	AUTOSTOP™	ONE-KEY™	11.0	0 - 2900	0 - 380	20 - 40	12.25	12.25	10.2 (M18 FB12)	PHDE72
1.	M18 CHM-121C	M18 FUEL™	-	-	6.1	0 - 3000	0 - 450	Ø 16 - 32	11.03	10.63	7.1 (M18 FB12)	PHDE72

SDS-PLUS

	Platform	Technology	ONE-KEY™	FIXTEC™	Blow energy (EPTA)(J)	Max. percussion rate (bpm)	No load speed (rpm)	Optimised drilling capacity in concrete (mm)	Vibration drilling (m/s²)	Vibration chiseling (m/s²)	Weight with battery pack (EPTA) (kg)	Fits MILWAUKEE® Dust Extractors
2.	M18 ONEFHP-0X	M18 FUEL™	ONE-KEY™	-	5.0	4600	0 - 800	8 - 24	8.46	7.92	5.0 (M18 HB5.5)	M18 FPDDXL
2.	M18 ONEFHPX-552X	M18 FUEL™	ONE-KEY™	✓	5.0	4600	0 - 800	8 - 24	8.46	7.92	5.2 (M18 HB5.5)	M18 FPDDXL
2.	M18 FHACOD32-0C	M18 FUEL™	ONE-KEY™	-	4.9	4600	0 - 800	8 - 24	10.5	9.4	5.9 (M18 HB5.5)	M18 FDDEL32
3.	M18 FH-0X	M18 FUEL™	-	-	2.5	4800	0 - 1330	8 - 24	17	14.2	4.3 (M18 HB5.5)	M18 FCDDXL/ M18 FDDEXL
3.	M18 FHX-552X	M18 FUEL™	-	✓	2.5	4800	0 - 1330	6 - 20	17	14.2	4.4 (M18 HB5.5)	M18 FCDDXL/ M18 FDDEXL
3.	M18 ONEFH-0X	M18 FUEL™	ONE-KEY™	-	2.5	4800	0 - 1330	6 - 20	17	14.2	4.3 (M18 HB5.5)	M18 FCDDXL/ M18 FDDEXL
3.	M18 ONEFHX-552X	M18 FUEL™	ONE-KEY™	✓	2.5	4800	0 - 1330	6 - 20	17	14.2	4.5 (M18 HB5.5)	M18 FCDDXL/ M18 FDDEXL
4.	M18 FHAF0H16-302X	M18 FUEL™	-	-	2.3	4740	0 - 1310	5.5 - 13	12.56	-	3.3 (M18 HB3)	Integrated dust extractor
4.	M18 FHAC16-302X	M18 FUEL™	-	-	1.7	5080	0 - 1400	5.5 - 13	13.6	10.9	2.6 (M18 HB3)	M18 FDDEC
4.	M18 BLH-502X	M18™	Brushless	-	2.3	5100	0 - 1400	6 - 18	14.9	12.7	3.3 (M18 B5)	M18 CDEX
4.	M18 BLHX-502X	M18™	Brushless	✓	2.3	4900	0 - 1400	6 - 18	14.9	12.7	3.5 (M18 B5)	M18 CDEX
4.	M18 BLHACD26-402X	M18™	Brushless	-	2.6	4600	0 - 1270	6 - 18	13.9	13.2	3.1 (M18 B4)	M18 CDEX
4.	M12 FHAC16-502X	M12 FUEL™	-	-	1.15	4410	0 - 1200	5.5 - 13	12.3	10.3	2.3 (M12 HB5)	M12 UDEL
5.	M18 BH-402C	M18™	-	-	1.2	7000	0 - 1300	5.5 - 13	10.91	-	2.5 (M18 B4)	M12 UDEL



SCAN HERE TO VIEW OUR PPE RANGE



SCAN HERE TO VIEW COMPATIBLE DRILL BITS



M18 FHM M18 FUEL

M18 FUEL™ ONE-KEY™ 8 KG SDS-MAX DRILLING AND BREAKING HAMMER



- The M18 FHM is the most productive SDS-Max tool MILWAUKEE® has produced, delivering AC power with the flexibility of the cordless M18™ platform
- The HIGH OUTPUT™ system of tools elevates the M18 FUEL™ technologies to a new level and delivers extended performance and extended run time. These tools are designed to maximise the partnership with HIGH OUTPUT™ and FORGE™ batteries

	M18 FHM-0C	M18 FHM-121C
Kit included	No batteries supplied, No charger supplied, Kitbox	1 x M18 FB12 Battery pack, M12-18 FC Charger, Kitbox
Article Number	4933464893	4933499269
EAN Code	4058546228385	4058546564339

M18 CHM M18 FUEL

M18 FUEL™ 5 KG SDS-MAX DRILLING AND BREAKING HAMMER



- The world's first 18V 5 kg SDS-Max hammer for maximum versatility and portability with equal performance to an AC tool
- Brushless POWERSTATE™ motor provides corded drilling performance
- REDLINK PLUS™ intelligence system delivers an advanced digital overload protection for tool and battery and uniquely enhances the tool performance under load

	M18 CHM-0C	M18 CHM-121C
Kit included	No batteries supplied, No charger supplied, Kitbox	1 x M18 FB12 Battery pack, M12-18 FC Charger, Kitbox
Article Number	4933451362	4933499271
EAN Code	4002395159208	4058546564353

M18 ONEFHPX M18 FUEL

M18 FUEL™ HIGH PERFORMANCE 4-MODE 32 MM SDS-PLUS HAMMER WITH ONE-KEY™ AND FIXTEC™ CHUCK



- Hardest hitting cordless SDS-Plus hammer in its class. Powerful hammer mechanism delivers 5.0 J (EPTA) of impact energy at low 8.46 m/s² vibrations
- Drills up to 10 Ø18 x 100 mm holes on a M18™ HIGH OUTPUT™ 5.5 Ah battery charge
- AUTOSTOP™ shuts down the tool to protect the user of sharp movement in bind up situations

	M18 ONEFHPX-0X	M18 ONEFHPX-552X
Kit included	No batteries supplied, No charger supplied, HD Box	2 x M18 HB5.5 Battery packs, M12-18 FC Charger, HD Box
Article Number	4933478495	4933478496
EAN Code	4058546346881	4058546346898

M18 FPDDEXL M18

DEDICATED DUST EXTRACTION FOR M18 FUEL™ 32 MM SDS-PLUS HAMMERS WITH AUTOPULSE™



- Designed to collect dust efficiently with automatic operation from the tools on/ off trigger switch
- AUTOPULSE™ industry's first on-board automatic filter cleaning mechanism for an on-tool dust extractor, which increases the air flow efficiency as well as the filter life time
- The highly efficient HEPA filter collects 99.97% of airborne particles down to 0.3 microns

	M18 FPDDEXL-0
Article Number	4933478509
EAN Code	4058546347024

M18 ONEFHPXDEL M18 FUEL

M18 FUEL™ HIGH PERFORMANCE SDS-PLUS HAMMER WITH DEDICATED DUST EXTRACTOR



- M18 ONEFHPX - M18 FUEL™ high performance 4-mode 32 mm SDS-Plus hammer with ONE-KEY™ and FIXTEC™ chuck
- M18 FPDDEXL - Dedicated dust extraction for M18 FUEL™ 32 mm SDS-Plus hammers with AUTOPULSE™

	M18 ONEFHPXDEL-552C
Kit included	2 x M18 HB5.5 Battery packs, M12-18 FC Charger, Kitbox
Article Number	4933478498
EAN Code	4058546346911

M18 ONEFHP M18 FUEL

M18 FUEL™ HIGH PERFORMANCE 4-MODE 32 MM SDS-PLUS HAMMER WITH ONE-KEY™



- Hardest hitting cordless SDS-Plus hammer in its class. Powerful hammer mechanism delivers 5.0 J (EPTA) of impact energy at low 8.46 m/s² vibrations
- Drills up to 10 Ø18 x 100 mm holes on a M18™ HIGH OUTPUT™ 5.5 Ah battery charge
- AUTOSTOP™ shuts down the tool to protect the user of sharp movement in bind up situations

	M18 ONEFHP-0X
Kit included	No batteries supplied, No charger supplied, HD Box
Article Number	4933478884
EAN Code	4058546361662

M18 FHACOD32 M18 FUEL

M18 FUEL™ 32 MM SDS-PLUS D-HANDLE HAMMER WITH ONE-KEY™



- D-handle with compact and ergonomic design for increased end user comfort
- Powerful hammer mechanism and the brushless motor design delivers 4.9 J of impact energy
- 4-mode operation: rotary hammer, hammer only, rotation only and variolock for maximum versatility
- Anti-vibration side handle for lower vibration exposure

	M18 FHACOD32-0C	M18 FHACOD32-0
Kit included	No batteries supplied, No charger supplied, Kitbox	No batteries supplied, No charger supplied, No kitbox or bag supplied
Article Number	4933492140	4933492141
EAN Code	4058546415075	4058546415082

M18 FDDEL32 M18

DEDICATED DUST EXTRACTION FOR M18 FUEL™ 32 MM SDS-PLUS D-HANDLE HAMMER WITH AUTOPULSE™



- Designed to collect dust efficiently with automatic operation from the tools on/ off trigger switch
- AUTOPULSE™ industry's first on-board automatic filter cleaning mechanism for an on-tool dust extractor, which increases the air flow efficiency as well as the filter life time
- The highly efficient HEPA filter collects 99.97% of airborne particles down to 0.3 microns

	M18 FDDEL32-0
Article Number	4933492142
EAN Code	4058546415099

M18 ONEFHX **M18 FUEL™ 4-MODE 26 MM SDS-PLUS HAMMER WITH FIXTEC™ CHUCK AND ONE-KEY™**



- The fastest drilling rotary hammer in its class leading to increased productivity
- Powerful hammer mechanism delivers 2.5 J of impact energy
- Drills up to 125 Ø10 x 50 mm holes on a M18™ HIGH OUTPUT™ 5.5 Ah battery charge
- AUTOSTOP™ shuts down the tool to protect the user of sharp movement in bind up situations

	M18 ONEFHX-0X	M18 ONEFHX-552X
Kit included	No batteries supplied, No charger supplied, HD Box	2 x M18 HB5.5 Battery packs, M12-18 FC Charger, HD Box
Article Number	4933478503	4933478504
EAN Code	4058546346966	4058546346973

M18 ONEFH **M18 FUEL™ 4-MODE 26 MM SDS-PLUS HAMMER WITH ONE-KEY™**



- The fastest drilling rotary hammer in its class leading to increased productivity
- Powerful hammer mechanism delivers 2.5 J of impact energy
- Drills up to 125 Ø10 x 50 mm holes on a M18™ HIGH OUTPUT™ 5.5 Ah battery charge
- AUTOSTOP™ shuts down the tool to protect the user of sharp movement in bind up situations

	M18 ONEFH-0X
Kit included	No batteries supplied, No charger supplied, HD Box
Article Number	4933478886
EAN Code	4058546361686

M18 FHX **M18 FUEL™ 4-MODE 26 MM SDS-PLUS HAMMER WITH FIXTEC™**



- The fastest drilling rotary hammer in its class leading to increased productivity
- Powerful hammer mechanism delivers 2.5 J of impact energy
- Drills up to 125 Ø10 x 50 mm holes on a M18™ HIGH OUTPUT™ 5.5 Ah battery charge
- AUTOSTOP™ shuts down the tool to protect the user of sharp movement in bind up situations

	M18 FHX-0X	M18 FHX-552X
Kit included	No batteries supplied, No charger supplied, HD Box	2 x M18 HB5.5 Battery packs, M12-18 FC Charger, HD Box
Article Number	4933478888	4933478889
EAN Code	4058546361709	4058546361716

M18 FH **M18 FUEL™ 4-MODE 26 MM SDS-PLUS HAMMER**



- The fastest drilling rotary hammer in its class leading to increased productivity
- Powerful hammer mechanism delivers 2.5 J of impact energy
- Drills up to 125 Ø10 x 50 mm holes on a M18™ HIGH OUTPUT™ 5.5 Ah battery charge
- AUTOSTOP™ shuts down the tool to protect the user of sharp movement in bind up situations

	M18 FH-0X
Kit included	No batteries supplied, No charger supplied, HD Box
Article Number	4933478500
EAN Code	4058546346935

M18 FDDEXL **DEDICATED DUST EXTRACTION FOR M18 FUEL™ 26 MM SDS-PLUS HAMMERS WITH AUTOPULSE™**



- Designed to collect dust efficiently with automatic operation from the tools on/ off trigger switch
- AUTOPULSE™ industry's first on-board automatic filter cleaning mechanism for an on-tool dust extractor, which increases the air flow efficiency as well as the filter life time
- The highly efficient HEPA filter collects 99.97% of airborne particles down to 0.3 microns

	M18 FDDEXL-0
Article Number	4933478508
EAN Code	4058546347017

M18 FCDDEXL **COMPACT DEDICATED DUST EXTRACTION FOR M18 FUEL™ 26 MM SDS-PLUS HAMMERS**



- Designed to collect dust efficiently with automatic operation from the tools on/ off trigger switch
- The highly efficient HEPA filter collects 99.97% of airborne particles down to 0.3 microns
- Manual filter cleaning mechanism increases the air flow efficiency as well as the filter life time

	M18 FCDDEXL-0
Article Number	4933478507
EAN Code	4058546347000

M18 ONEFHXLDEL **M18 FUEL™ 4-MODE 26 MM SDS-PLUS HAMMER WITH FIXTEC™ CHUCK, ONE-KEY™ AND WITH DEDICATED DUST EXTRACTOR**



- M18 ONEFHX - M18 FUEL™ 4-mode 26 mm SDS-Plus hammer with FIXTEC™ chuck and ONE-KEY™
- M18 FDDEXL - Dedicated dust extraction for M18 FUEL™ 26 mm SDS-Plus hammers with AUTOPULSE™

	M18 ONEFHXLDEL-552X
Kit included	2 x M18 HB5.5 Battery packs, M12-18 FC Charger, Kitbox
Article Number	4933478506
EAN Code	4058546346997

M18 FHAF0H16 **M18 FUEL™ 16 MM SDS-PLUS HAMMER WITH INTEGRATED DUST EXTRACTOR**



- World's first integrated dust extractor drilling hammer
- The highly efficient HEPA filter collects 99.97% of airborne particles down to 0.3 microns
- AUTOSTOP™ shuts down the tool to protect the user of sharp movement in bind up situations
- Optimised for overhead applications

	M18 FHAF0H16-0	M18 FHAF0H16-0X	M18 FHAF0H16-302X
Kit included	No batteries supplied, No charger supplied, No kitbox or bag supplied	No batteries supplied, No charger supplied, HD Box	2 x M18 HB3 Battery packs, M12-18 FC Charger, HD Box
Article Number	4933493531	4933493532	4933493533
EAN Code	4058546484026	4058546484033	4058546484040

M18 FHAC16

M18 FUEL™ HIGH PERFORMANCE 4-MODE 16 MM SDS-PLUS HAMMER

M18 FUEL

AUTOSTOP



- The most compact and fastest drilling rotary hammer in its class leading to increased productivity and comfort
- Powerful hammer mechanism delivers 1.7 J of impact energy
- Drills up to 58 holes Ø10 x 50 mm on a M18™ HIGH OUTPUT™ 3.0 Ah battery charge
- AUTOSTOP™ shuts down the tool to protect the user of sharp movement in bind up situations

	M18 FHAC16-0	M18 FHAC16-0X	M18 FHAC16-302X
Kit included	No batteries supplied, No charger supplied, No kitbox or bag supplied	No batteries supplied, No charger supplied, HD Box	2 x M18 HB3 Battery packs, M12-18 FC Charger, HD Box
Article Number	4933498582	4933498583	4933498584
EAN Code	4058546524517	4058546524524	4058546524531

M18 FDDEC

M18™ DEDICATED DUST EXTRACTOR FOR M18 FUEL™ HIGH PERFORMANCE 4-MODE 16 MM SDS-PLUS HAMMER

M18



- Designed to collect dust effectively with automatic operation from the tools on/off trigger switch
- HEPA Filter: widely regarded as the ultimate filter that traps all sizes of particles with an efficiency rating of 99.75%
- Large dust collection box
- Dust extraction aluminium tube is adjustable according to the size of the drill bit and length 16 mm max and 90 mm depth

	M18 FDDEC-0
Kit included	No batteries supplied, No charger supplied, No kitbox or bag supplied
Article Number	4933498587
EAN Code	4058546524562

M18 FHACDDE

M18 FUEL™ HIGH PERFORMANCE 4-MODE 16 MM SDS-PLUS HAMMER WITH DEDICATED DUST EXTRACTOR

M18 FUEL



- M18 FHAC16 - M18 FUEL™ high performance 4-mode 16 mm SDS-Plus hammer
- M18 FDDEC - M18™ dedicated dust extractor for M18 FUEL™ high performance 4-mode 16 mm SDS-Plus hammer

	M18 FHACDDE-0C
Kit included	No batteries supplied, No charger supplied, Kitbox
Article Number	4933498586
EAN Code	4058546524555

M18 BLHX

M18™ BRUSHLESS 4-MODE 26 MM SDS-PLUS HAMMER WITH FIXTEC™ CHUCK

M18

BRUSHLESS



- Powerful hammer mechanism and the brushless motor design delivers 2.3 J of impact energy
- Compact, ergonomic design for increased end user comfort
- FIXTEC™ system for keyless chuck changing between SDS-Plus and 13 mm metal chuck
- All metal gear case - optimum seating of the gears for enhanced tool life

	M18 BLHX-0X	M18 BLHX-502X
Kit included	No batteries supplied, No charger supplied, HD Box	2 x M18 B5 Battery packs, M12-18 FC Charger, HD Box
Article Number	4933478891	4933478892
EAN Code	4058546361730	4058546361747

M18 BLH

M18™ BRUSHLESS 4-MODE 26 MM SDS-PLUS HAMMER

M18

BRUSHLESS



- Powerful hammer mechanism and the brushless motor design delivers 2.3 J of impact energy
- Compact, ergonomic design for increased end user comfort
- All metal gear case - optimum seating of the gears for enhanced tool life
- 4-mode operation: rotary hammer, hammer only, rotation only and selectable work position of the chisel (variolock) for maximum versatility

	M18 BLH-0	M18 BLH-502X
Kit included	No batteries supplied, No charger supplied, No kitbox or bag supplied	2 x M18 B5 Battery packs, M12-18 FC Charger, HD Box
Article Number	4933479426	4933478894
EAN Code	4058546372200	4058546361761

M18 CDEX

M18 FUEL™ SDS-PLUS DUST EXTRACTOR

M18



- Designed to collect dust effectively with automatic operation from the tools on/off trigger switch
- HEPA Filter: widely regarded as the ultimate filter that traps all sizes of particles with an efficiency rating of 99.75%
- Large dust collection box
- Dust extraction aluminium tube is adjustable according to the size of the drill bit and length 16 mm max and 90 mm depth

	M18 CDEX-0
Article Number	4933447450
EAN Code	4002395006243

M18 BLHACD26

M18™ BRUSHLESS 26 MM SDS-PLUS D-HANDLE HAMMER

M18

BRUSHLESS



- D-handle with lightweight and ergonomic design for increased end user comfort
- Powerful hammer mechanism and the brushless motor design delivers 2.6 J of impact energy
- 4-mode operation: rotary hammer, hammer only, rotation only and variolock for maximum versatility
- Anti-vibration system (AVS) for decreased user fatigue and lower vibration exposure

	M18 BLHACD26-0X	M18 BLHACD26-402X
Kit included	No batteries supplied, No charger supplied, HD Box	2 x M18 B4 Battery packs, M12-18 C Charger, HD Box
Article Number	4933492482	4933492480
EAN Code	4058546418496	4058546418472

M18 BH

M18™ COMPACT 2-MODE SDS-PLUS HAMMER

M18



- Superior power to weight ratio in its class 2.5 kg 1.2 J (EPTA)
- High performance 4-pole motor delivers maximum power whilst maximising the power to weight ratio
- REDLINK™ overload protection electronics in tool and battery pack deliver best in class system durability
- 2-mode operation: choose rotary hammer or rotation only for maximum versatility

	M18 BH-0	M18 BH-402C
Kit included	No batteries supplied, No charger supplied, No kitbox or bag supplied	2 x M18 B4 Battery packs, M12-18 C Charger, Kitbox
Article Number	4933443320	4933443330
EAN Code	4002395003730	4002395003747

M18 FCOS230
M18 FUEL™ CUT-OFF SAW

M18 FUEL



- The world's first 18V 230 mm battery powered cut-off saw, delivers the power to cut reinforced concrete, whilst being 50% lighter than other petrol comparisons
- Starts up instantly, eliminates the need to mix petrol and oil, and avoids petrol engine maintenance
- Can be used indoors due to zero fume emissions

	M18 FCOS230-0	M18 FCOS230-121
Kit included	No batteries supplied, No charger supplied, No kitbox or bag supplied	1 x M18 FB12 Battery pack, M12-18 FC Charger, No kitbox or bag supplied
Article Number	4933471696	4933499175
EAN Code	4058546295950	4058546563394

M18 FCVN
M18 FUEL™ NEEDLE CONCRETE VIBRATOR

M18 FUEL



- M18 FUEL™ Needle Vibrator for consolidation of concrete with a compact design
- 1.2 m whip length execution recommended for footings or small flatwork (M18 FCVN12)
- 2.4 m whip length execution recommended for walls or columns (M18 FCVN24)
- 25 mm² head design and 12,500 VPM for an improved consolidation power
- Variable speed trigger for ideal adaption to each material and formwork size

	M18 FCVN12-0	M18 FCVN12-551	M18 FCVN24-0	M18 FCVN24-551
Kit included	No batteries supplied, No charger supplied, No kitbox or bag supplied	1 x M18 HB5.5 Battery pack, M12-18 FC Charger, No kitbox or bag supplied	No batteries supplied, No charger supplied, No kitbox or bag supplied	1 x M18 HB5.5 Battery pack, M12-18 FC Charger, No kitbox or bag supplied
Article Number	4933479596	4933479597	4933479599	4933479600
EAN Code	4058546373900	4058546373917	4058546373931	4058546373948

M18 ONEPD3
M18 FUEL™ ONE-KEY™ PERCUSSION DRILL

M18 FUEL



- Higher power efficiency under load - outstanding torque of 158 Nm
- Extremely compact design of 175 mm length for access into tight spaces
- Connect via Bluetooth® with the ONE-KEY™ app
- Save up to 3 custom settings to the tools memory for fast selection on the jobsite

	M18 ONEPD3-0X	M18 ONEPD3-502X
Kit included	No batteries supplied, No charger supplied, HD Box	2 x M18 B5 Battery packs, M12-18 FC Charger, HD Box
Article Number	4933492798	4933492801
EAN Code	4058546476694	4058546476724

M18 FPD3
M18 FUEL™ PERCUSSION DRILL

M18 FUEL



- Higher power efficiency under load with outstanding torque of 158 Nm
- Extremely compact design of 175 mm length for access into tight spaces
- AUTOSTOP™ control mode offers enhanced safety for the operator by preventing over-rotation in a bind-up
- 13 mm metal chuck for quick bit changes and bit retention

	M18 FPD3-0X	M18 FPD3-502X
Kit included	No batteries supplied, No charger supplied, HD Box	2 x M18 B5 Battery packs, M12-18 FC Charger, HD Box
Article Number	4933479859	4933479860
EAN Code	4058546376536	4058546376543

M18 FPM
M18 FUEL™ PADDLE MIXER

M18 FUEL



- POWERSTATE™ brushless motor delivers the power to mix heavy compounds, such as concrete and mortar
- Ultimate speed control: 3 different ways of controlling speed for clean and consistent mixes (8-speed setting dial, variable speed trigger and a lock on button)
- 180° adjustable handle with 16 adjustable settings for user to optimise the handle position based on preference and comfort

	M18 FPM-0X
Kit included	No batteries supplied, No charger supplied, HD Box
Article Number	4933459719
EAN Code	4058546028916

M18 BLCHTO
M18™ BRUSHLESS 1 TON CHAIN HOIST WITH ONE-KEY™

M18



- 1 ton lifting capacity to lift a wide variety of materials
- Up to 6 m lift height to cover all applications
- Remote control operated for safe applications from a distance
- Chain stop within 1 second for precise and safe working
- Micro movement & soft-start for precise work
- AUTOSTOP when the load chain is fully retracted or extended

	M18 BLCHTO-121
Kit included	1 x M18 FB12 Battery pack, M12-18 FC Charger,
Article Number	4933500224
EAN Code	4058546615260

M18 ONEDD3
M18 FUEL™ ONE-KEY™ DRILL DRIVER

M18 FUEL



- Higher power efficiency under load - outstanding torque of 158 Nm
- Extremely compact design of 173 mm length for access into tight spaces
- Connect via Bluetooth® with the ONE-KEY™ app
- Save up to 3 custom settings to the tools memory for fast selection on the jobsite

	M18 ONEDD3-0X	M18 ONEDD3-502X
Kit included	No batteries supplied, No charger supplied, HD Box	2 x M18 B5 Battery packs, M12-18 FC Charger, HD Box
Article Number	4933492799	4933492802
EAN Code	4058546476700	4058546476731

M18 FDD3
M18 FUEL™ DRILL DRIVER

M18 FUEL



- Higher power efficiency under load with outstanding torque of 158 Nm
- Extremely compact design of 173 mm length for access into tight spaces
- AUTOSTOP™ control mode offers enhanced safety for the operator by preventing over-rotation in a bind-up
- Fastest drilling and driving applications under load
- Brighter LED workspace illumination

	M18 FDD3-0X	M18 FDD3-502X
Kit included	No batteries supplied, No charger supplied, HD Box	2 x M18 B5 Battery packs, M12-18 FC Charger, HD Box
Article Number	4933479862	4933479863
EAN Code	4058546376567	4058546376574

GET THE RIGHT PERCUSSION DRILL FOR THE JOB

1 FUEL™



2 BRUSHLESS



3 COMPACT BRUSHLESS



	Platform	Technology	ONE-KEY™	Feature	No load speed (rpm)	Max. drilling wood/ steel/ masonry (mm)	Max. percussion rate (bpm)	Max. torque (Nm)	Chuck capacity (mm)	Weight with battery pack (EPTA) (kg)
1.	M18 ONEPD3-502X	M18 FUEL™	ONE-KEY™	-	0 - 500/ 0 - 2100	89/ 16/ 16	0 - 33,000	158	13	2.2 (M18 B5)
1.	M18 FPD3-502X	M18 FUEL™	-	AUTOSTOP™	0 - 500/ 0 - 2100	89/ 16/ 16	0 - 33,000	158	13	2.2 (M18 B5)
1.	M12 FPD2-602X	M12 FUEL™	-	-	0 - 450/ 0 - 1,550	35/ 13/ 13	0 - 22,500	45	13	1.4 (M12 B6)
2.	M18 BLPD2-502X	M18™	Brushless	-	0 - 550/ 0 - 1800	76/ 13/ 16	0 - 28,800	82	13	2.1 (M18 B5)
3.	M18 BLPDRC-502C	M18™	Compact Brushless	-	0-550/ 0-1700	52/ 13/ 16	0 - 25,500	60.5	13	1.5 (M18 B5)



SCAN HERE TO VIEW OUR PPE RANGE



SCAN HERE TO VIEW COMPATIBLE DRILL BITS

REDLITHIUM™

M18 BLPD2
M18™ BRUSHLESS PERCUSSION DRILL

M18

BRUSHLESS



- New brushless motor design delivers 40% more torque than previous model - up to 82 Nm
- Compact design (180 mm in length) provides excellent balance and control, ideal for overhead applications or work in tight spaces
- Advanced 13 mm heavy duty metal chuck for quick bit changes and superior bit retention
- Optimised speed for faster drilling & fastening (0 - 550/ 0 - 1800 rpm)

	M18 BLPD2-0X	M18 BLPD2-402X	M18 BLPD2-502X
Kit included	No batteries supplied, No charger supplied, HD Box	2 x M18 B4 Battery packs, M12-18 FC Charger, HD Box	2 x M18 B5 Battery packs, M12-18 FC Charger, HD Box
Article Number	4933464516	4933464560	4933464517
EAN Code	4058546224615	4058546225056	4058546224622

M18 BLDD2
M18™ BRUSHLESS DRILL DRIVER

M18

BRUSHLESS



- New brushless motor design delivers 40% more torque than previous model - up to 82 Nm
- Compact design (180 mm in length) provides excellent balance and control, ideal for overhead applications or work in tight spaces
- Advanced 13 mm heavy duty metal chuck for quick bit changes and superior bit retention
- Optimised speed for faster drilling & fastening (0 - 550/ 0 - 1800 rpm)

	M18 BLDD2-0X	M18 BLDD2-402X	M18 BLDD2-502X
Kit included	No batteries supplied, No charger supplied, HD Box	2 x M18 B4 Battery packs, M12-18 C Charger, HD Box	2 x M18 B5 Battery packs, M12-18 FC Charger, HD Box
Article Number	4933464514	4933464559	4933464515
EAN Code	4058546224592	4058546225049	4058546224608

M18 BLPDRC
M18™ COMPACT BRUSHLESS PERCUSSION DRILL

M18

COMPACT BRUSHLESS



- Compact brushless percussion drill measuring 145 mm in length for access into tight spaces
- Advanced 13 mm heavy duty metal chuck for quick bit changes and superior bit retention
- 60.5 Nm of torque - best power to size ratio
- All metal reversible belt clip to hang your tool quickly and easily
- On board fuel gauge and LED light

	M18 BLPDRC-0X	M18 BLPDRC-202C	M18 BLPDRC-502C
Kit included	No batteries supplied, No charger supplied, HD Box	2 x M18 B4 Battery packs, M12-18 C Charger, Kitbox	2 x M18 B5 Battery packs, M12-18 C Charger, Kitbox
Article Number	4933492821	4933492822	4933492826
EAN Code	4058546476922	4058546476939	4058546476977

M18 BLDDRC
M18™ COMPACT BRUSHLESS DRILL DRIVER

M18

COMPACT BRUSHLESS



- Compact brushless drill driver measuring 145 mm in length for access into tight spaces
- Advanced 13 mm heavy duty metal chuck for quick bit changes and superior bit retention
- 60.5 Nm of torque - best power to size ratio
- All metal reversible belt clip to hang your tool quickly and easily
- On board fuel gauge and LED light

	M18 BLDDRC-0X	M18 BLDDRC-202C	M18 BLDDRC-502C
Kit included	No batteries supplied, No charger supplied, HD Box	2 x M18 B4 Battery packs, M12-18 C Charger, Kitbox	2 x M18 B5 Battery packs, M12-18 C Charger, Kitbox
Article Number	4933492832	4933492833	4933492835
EAN Code	4058546477035	4058546477042	4058546477066

M18 FRAD2
M18 FUEL™ SUPER HAWG® 2-SPEED RIGHT ANGLE DRILL DRIVER GEN II

M18 FUEL



- Extremely long run time, up to 100 holes with a 65 mm auger bit into wood
- POWERSTATE™ brushless motor provides constant power under load to power through 152 mm holes
- Mechanical clutch protects the tool in the event of a stall
- Compact design allows working in confined spaces
- On board fuel gauge and LED light

	M18 FRAD2-0
Kit included	No batteries supplied, No charger supplied, No kitbox or bag supplied
Article Number	4933471207
EAN Code	4058546288358

M18 CRAD2
M18 FUEL™ RIGHT ANGLE DRILL

M18 FUEL



- Delivers corded power and speed (1500 rpm) in wood drilling applications
- All metal gear case and 13 mm keyed chuck
- Extremely long run time with a 5.5 Ah battery pack drills up to 200 holes with a 22 mm auger bit into 50 x 100 mm wood

	M18 CRAD2-0X
Kit included	No batteries supplied, No charger supplied, HD Box
Article Number	4933471641
EAN Code	4058546295400

C18 RAD
M18™ COMPACT RIGHT ANGLE DRILL

M18



- Optimised performance: 1500 rpm at 20 Nm
- REDLINK™ overload protection electronics in tool and battery pack deliver best in class system durability
- Perfect speed to power ratio for fast application completion
- 10 mm single sleeve ratcheting chuck provides maximum versatility and grip
- 100 mm compact head designed to fit in the tightest work areas

	C18 RAD-0
Kit included	No batteries supplied, No charger supplied, No kitbox or bag supplied
Article Number	4933427189
EAN Code	4002395239085

M18 ONEID3
M18 FUEL™ ONE-KEY™ 1/4" HEX IMPACT DRIVER

M18 FUEL



- Save up to 3 custom settings to the tools memory for fast selection on the jobsite
- Connect via Bluetooth® with the ONE-KEY™ app
- Faster driving speed vs. previous model, up to 3900 rpm and 4400 ipm
- Extremely compact design of 113 mm length for access into tight spaces
- Adjustable trigger control for all applications with ONE-KEY™

	M18 ONEID3-0X	M18 ONEID3-502X
Kit included	No batteries supplied, No charger supplied, HD Box	2 x M18 B5 Battery packs, M12-18 FC Charger, HD Box
Article Number	4933492800	4933492804
EAN Code	4058546476717	4058546476755

GET THE RIGHT IMPACT DRIVER FOR THE JOB

1 FUEL™



2 BRUSHLESS



3 COMPACT BRUSHLESS



4 BRUSHED



	Battery system	Technology	ONE-KEY™	No load speed (rpm)	Impact rate (ipm)	Max. torque (Nm)	Tool reception	Max. bolt diameter	Weight with battery pack (EPTA) (kg)
1.	M18 ONEID3-502X	M18 FUEL™	ONE-KEY™	1750/3000/4000/0-4000	1200/3400/4300/0-4400	119/176/226/0-226	¼" Hex	M16	1.7 (M18 B5)
1.	M18 FID3-502X	M18 FUEL™	-	1750/3000/3900/0-3900	1400/3600/4400/0-4400	226	¼" Hex	M16	1.7 (M18 B5)
1.	M12 FID2-602X	M12 FUEL™	-	1700/2900/3600/3600	1300/3500/4000/0-4000	170	¼" Hex	M14	1.1 (M12 B6)
1.	M18 FQID-502X	M18 FUEL™	SURGE™	900/2100/3000/0-3000	1800/2900/4000/0-4000	50	¼" Hex	M14	1.7 (M18 B5)
1.	M12 FQID-202X	M12 FUEL™	SURGE™	1100/2200/3200/3200	950/2200/3400/3400	50	¼" Hex	M14	1.1 (M12 B2)
2.	M18 BLIDR-502X	M18™	Brushless	1250/2400/3600	2500/4700/4900	190	¼" Hex	M14	1.3 (M18 B5)
3.	M18 BLIDRC-402C	M18™	Compact Brushless	0 - 3600	0 - 4900	190	¼" Hex	M14	1.3 (M18 B4)
4.	M18 BRAID-0	M18™	-	1500/ 2250	2400/3400	41/ 81	¼" Hex	M14	1.8 (M18 B5)
4.	M12 BRAID-0	M12™	-	0 - 2425	0 - 3300	68	¼" Hex	M12	1.2 (M12 B2)



SCAN HERE TO VIEW OUR PPE RANGE



SCAN HERE TO VIEW COMPATIBLE IMPACT BITS

REDLITHIUM™

M18 FID3
M18 FUEL™ 1/4" HEX IMPACT DRIVER

M18 FUEL

AUTO STOP



- Higher power efficiency under load with outstanding torque of 226 Nm
- Faster driving speed vs. previous model, up to 3900 rpm and 4400 ipm
- Extremely compact design, total length of just 113 mm for access into tight spaces
- DRIVE CONTROL allows the user to shift into four different speed and torque settings to maximise application versatility
- Mode 1 for precision work

	M18 FID3-0X	M18 FID3-502X
Kit included	No batteries supplied, No charger supplied, HD Box	2 x M18 B5 Battery packs, M12-18 FC Charger, HD Box
Article Number	4933479864	4933479865
EAN Code	4058546376581	4058546376598

M18 FQID
M18 FUEL™ SURGE™ 1/4" HEX HYDRAULIC IMPACT DRIVER

M18 FUEL

SURGE™
HYDRAULIC DRIVER



- The M18 FUEL™ SURGE™ 1/4" Hex hydraulic driver is MILWAUKEE®'s quietest impact driver
- FLUID-DRIVE™ hydraulic powertrain reduces metal on metal contact within the tool, delivering quieter operation, smoother performance and increased durability over a standard impact
- Delivers same performance in wood fastening as standard brushless impact drivers

	M18 FQID-0X	M18 FQID-502X
Kit included	No batteries supplied, No charger supplied, HD Box	2 x M18 B5 Battery packs, M12-18 FC Charger, HD Box
Article Number	4933459187	4933451790
EAN Code	4002395289226	4002395277636

M18 BLIDR
M18™ BRUSHLESS 1/4" HEX IMPACT DRIVER

M18

BRUSHLESS



- Brushless impact driver measures only 112 mm in length making it ideal for working within confined spaces
- Brushless motor technology delivers 190 Nm of torque, 3600 rpm and 4900 ipm
- 3-Mode DRIVE CONTROL allows the user to shift into three different speed and torque settings to maximise application versatility
- One-handed bit insert with retention lock, for faster, easier changing of bits

	M18 BLIDR-0X	M18 BLIDR-502X
Kit included	No batteries supplied, No charger supplied, HD Box	2 x M18 B5 Battery packs, M12-18 FC Charger, HD Box
Article Number	4933492842	4933492843
EAN Code	4058546477134	4058546477141

M18 BLIDRC
M18™ COMPACT BRUSHLESS 1/4" HEX IMPACT DRIVER

M18

COMPACT BRUSHLESS



- Brushless impact driver measures only 112 mm in length making it ideal for working within confined spaces
- Brushless motor technology delivers 190 Nm of torque, 3600 rpm and 4900 ipm
- One-handed bit insert with retention lock, for faster, easier changing of bits
- Heavy duty full metal gearbox and gears for superior durability and maximum torque
- On board fuel gauge and LED light

	M18 BLIDRC-0	M18 BLIDRC-402C
Kit included	No batteries supplied, No charger supplied, No kitbox or bag supplied	2 x M18 B4 Battery packs, M12-18 C Charger, Kitbox
Article Number	4933492839	4933492840
EAN Code	4058546477103	4058546477110

M18 BRAID
M18™ RIGHT ANGLE IMPACT DRIVER

M18



- Compact right angle impact driver measures 307 mm in length making it ideal for working within confined spaces
- REDLINK™ overload protection electronics in tool and battery pack deliver best in class system durability
- Full metal gearbox and gears for superior durability and maximum torque
- Compact 53 mm head design

	M18 BRAID-0
Kit included	No batteries supplied, No charger supplied, No kitbox or bag supplied
Article Number	4933447891
EAN Code	4002395006663

M18 FSGC
M18 FUEL™ SCREW GUN WITH A COLLATED ATTACHMENT

M18 FUEL



- Fine adjustment nose cone for setting desired countersink levels in single screw applications
- Removable collated attachment allows the user to use the gun as a stand alone screwdriver or a collaged screw gun
- Reinforced collated attachment to protect against dropping of tool

	M18 FSGC-202X
Kit included	2 x M18 B2 Battery packs, M12-18 FC Charger, HD Box
Article Number	4933459199
EAN Code	4002395289943

M18 FSG
M18 FUEL™ SCREW GUN

M18 FUEL



- Fine adjustment nose cone for setting desired countersink levels in single screw applications
- Quick release 1/4" Hex chuck allows for easy bit change
- AUTO-START™ technology: When activated the power only engages when the screw gun is pushed into the material during application, delivering outstanding run time
- On board fuel gauge and LED light

	M18 FSG-0X
Kit included	No batteries supplied, No charger supplied, HD Box
Article Number	4933459201
EAN Code	4002395289967

M18 ONEFMTIW2FC12
M18 FUEL™ ONE-KEY™ TORQUE-SENSE™ 1/2" CONTROLLED SOLAR MID-TORQUE IMPACT WRENCH WITH FRICTION RING

M18 FUEL

ONE-KEY™
UNLOCKING THE ORIGINAL JOBSITE



- TORQUE-SENSE™ torque control delivers greater torque repeatability than blow counting impact wrenches by utilising proprietary sensors and machine learning algorithms to overcome common job site variability. Customisable torque ranges from 67 to 338 Nm

	M18 ONEFMTIW2FC12-0X
Kit included	No batteries supplied, No charger supplied, HD Box
Article Number	4933493413
EAN Code	4058546482848

GET THE RIGHT IMPACT WRENCH FOR THE JOB

1 HIGH TORQUE

For the most demanding applications in railway, (semi) truck, metal construction and utility maintenance



2 MID TORQUE

Most versatile for personal vehicles, commercial plumbing, metal structures, solar and light equipment maintenance



	Platform	Technology	ONE-KEY™	No load speed (rpm)	Impact rate (ipm)
1.	M18 FHIWF1R-122C	M18 FUEL™	-	1000 / 1400 / 1670 / 1670	1750 / 2150 / 2500 / 2500
1.	M18 ONEFHIWF1D-121C	M18 FUEL™	ONE-KEY™	600 / 700 / 900 / 1200	750 / 930 / 1200 / 1440
1.	M18 ONEFHIWF1DS-121C	M18 FUEL™	ONE-KEY™	600 / 700 / 900 / 1200	750 / 930 / 1200 / 1440
1.	M18 ONEFHIWH716-502X	M18 FUEL™	ONE-KEY™	0-900/ 0-1200/ 0-1800/ 0-2300	0-800/ 0-1300/ 0-2600/ 0-2800
1.	M18 ONEFHIWF34-502X	M18 FUEL™	ONE-KEY™	0-800/ 0-1300/ 0-1800/ 0-1800	0-850/ 0-1850/ 0-2400/ 0-2400
1.	M18 ONEFHIWF1-802X	M18 FUEL™	ONE-KEY™	0-950 / 0-1080 / 0-1370 / 0-1670	1350 / 1650 / 2100 / 0-2500
1.	M18 ONEFHIWF12-502X	M18 FUEL™	ONE-KEY™	0-550/ 0-1400/ 0-1750/ 0-1750	0-950/ 0-1750/ 0-2100/ 0-2100
1.	M18 ONEFHIWF12E-0X	M18 FUEL™	ONE-KEY™	0-1200/ 0-1800/ 0-1800/ 0-1800	0-1600/ 0-2400/ 0-2400/ 0-2400
1.	M18 ONEFHIWP12-502X	M18 FUEL™	ONE-KEY™	0-950/ 0-1500/ 0-1800/ 0-1800	0-1150/ 0-2100/ 0-2400/ 0-2400
1.	M18 FHIW2F12-502X	M18 FUEL™	-	0-700/ 0-1300/ 0-2000/ 0-2000	0-1300/ 0-2200/ 0-2400/ 0-2400
1.	M18 FHIW2P12-502X	M18 FUEL™	-	0-700/ 0-1300/ 0-2000/ 0-2000	0-1400/ 0-2500/ 0-2700/ 0-2700
1.	M18 BLHIWF12-0X	M18™	Brushless	0 - 1750	0 - 2000
2.	M18 ONEFMTIW2FC12-0X	M18 FUEL™	ONE-KEY™	0 - 1250 / 0 - 1725 / 0 - 2000 / 0-2400	0 - 1800 / 0 - 2300 / 0 - 2800 / 0 - 3400
2.	M18 FMTIW2F12-502X	M18 FUEL™	-	0-1200/ 0-1950/ 0-2575/ 0-1325	0-900/ 0-2100/ 0-3100
2.	M18 FMTIW2P12-502X	M18 FUEL™	-	0-1250/ 0-1950/ 0-2575/ 0-1325	0-900/ 0-2100/ 0-3100
2.	M18 FMTIW2F38-502X	M18 FUEL™	-	0-1200/ 0-1950/ 0-2575/ 0-1325	0-900/ 0-2100/ 0-3100
3.	M18 ONEFIW2FC12-0X	M18 FUEL™	ONE-KEY™	0 - 1125 / 0 - 1525 / 0 - 1850 / 0 - 2325	0 - 1650 / 0 - 2475 / 0 - 3000 / 0 - 3500
3.	M18 ONEIWF12-502X	M18 FUEL™	ONE-KEY™	900/ 1400/ 1900/ 2500	1300/ 2100/ 2550/ 3200
3.	M18 ONEIWP12-502X	M18 FUEL™	ONE-KEY™	900/ 1400/ 1900/ 2500	1300/ 2100/ 2550/ 3200
3.	M18 FIW2F12-502X	M18 FUEL™	-	0-900/ 0-1650/ 0-2400/ 0-1200	0-1000/ 0-2400/ 0-3500
3.	M18 FIW2P12-502X	M18 FUEL™	-	0-900/ 0-1650/ 0-2400/ 0-1200	0-1000/ 0-2400/ 0-3500
3.	M18 FIW2F38-0X	M18 FUEL™	-	0-800/ 0-1650/ 0-2400/ 0-1000	0-1000/ 0-2400/ 0-3500
3.	M18 FMTIW2F12-502X	M18 FUEL™	-	0-1200/ 0-1950/ 0-2575/ 0-1325	0-900/ 0-2100/ 0-3100
3.	M18 FMTIW2P12-502X	M18 FUEL™	-	0-1250/ 0-1950/ 0-2575/ 0-1325	0-900/ 0-2100/ 0-3100
3.	M18 FMTIW2F38-502X	M18 FUEL™	-	0-1200/ 0-1950/ 0-2575/ 0-1325	0-900/ 0-2100/ 0-3100
3.	M12 FCIWF12G3-502X	M12 FUEL™	-	0-930/ 0-2100/ 0-3000/ 0-1300	0-1500 / 0-3000 / 0-3300 / -
3.	M12 FCIWP12G3-0	M12 FUEL™	-	0-930/ 0-2100/ 0-3000/ 0-1300	0-1500 / 0-3000 / 0-3300 / -
3.	M12 FCIWF38G3-502X	M12 FUEL™	-	0-930/ 0-2100/ 0-3000/ 0-1300	0-1500 / 0-3000 / 0-3300 / -
3.	M12 FIW14-0	M12 FUEL™	-	1300/ 1900/ 3200/ 3200	1300/ 2000/ 4300
3.	M18 BIW12-402C	M18™	-	0 - 2450	0 - 3350
3.	M18 BIW38-0	M18™	-	0 - 2450	0 - 3350
3.	M12 BIW12-202C	M12™	-	0 - 2550	0 - 3400
3.	M12 BIW38-0	M12™	-	0 - 2500	0 - 3300



3 **LOW TORQUE**

More compact, for light applications in tight spaces in personal vehicle maintenance, plumbing, electrical, construction and solar

Tool reception	Max. torque (Nm)	Nut-busting torque (Nm)	Max. bolt diameter	Weight with battery pack (EPTA) (kg)
1" square	730 / 1500 / 2000	2000	M42	7.8 (M18 FB12)
1" square	1180 / 1254 / 1966 / 2576	2711	M42	12.7 (M18 FB12)
1" square	1180 / 1254 / 1966 / 2576	2711	M42	11.1 (M18 FB12)
7/16" Hex	1017	1017	M24	3.3 (M18 B5)
3/4" square	702/ 1138/ 1627/ 1627	2034	M33	3.5 (M18 B5)
1" square	530 / 1020 / 1800 / 2033	2400	M42	5.9 (M18 FB8)
1/2" square	130/ 400/ 1356/ 1356	1898	M33	3.3 (M18 B5)
1/2" square	102/ 203/ 610/ 1017	1500	M33	3.3 (M18 B5)
1/2" square	190/ 400/ 1017/ 1017	1491	M24	3.2 (M18 B5)
1/2" square	881 / 1220 / 1491 / 68	2034	M36	3.4 (M18 B5)
1/2" square	475 / 1017 / 1220 / 68	1491	M36	3.4 (M18 B5)
1/2" square	1085	1627	M36	3.4 (M18 B5)
1/2" square	338	746	M22	2.5 (M18 B5)
1/2" square	475/ 610/ 745/ 47	881	M22	2.3 (M18 B5)
1/2" square	475/ 610/ 745/ 47	881	M22	2.3 (M18 B5)
3/8" square	475/ 610/ 745/ 47	813	M22	2.3 (M18 B5)
1/2" square	203	298	M22	2.0 (M18 B5)
1/2" square	40/ 120/ 220/ 300	300	M16	1.8 (M18 B5)
1/2" square	40/ 120/ 220/ 300	300	M16	1.8 (M18 B5)
1/2" square	102/ 203/ 339/ 34	339	M16	1.8 (M18 B5)
1/2" square	102/ 203/ 339/ 34	339	M16	1.8 (M18 B5)
3/8" square	102/ 203/ 339/ 34	339	M16	1.8 (M18 B5)
1/2" square	475/ 610/ 745/ 47	881	M22	2.3 (M18 B5)
1/2" square	475/ 610/ 745/ 47	881	M22	2.3 (M18 B5)
3/8" square	475/ 610/ 745/ 47	813	M22	2.3 (M18 B5)
1/2" square	271 / 406 / 542 / 20	745	M16	1.5 (M12 HB5)
1/2" square	271 / 406 / 542 / 20	745	M16	1.5 (M12 HB5)
3/8" square	271 / 406 / 542 / 20	745	M16	1.5 (M12 HB5)
1/4" square	136	136	M12	0.90 (M12 B4)
1/2" square	240	240	M14	1.9 (M18 B4)
3/8" square	210	210	M14	1.9 (M18 B4)
1/2" square	138	138	M12	1.0 (M12 B2)
3/8" square	135	135	M12	1.0 (M12 B2)



SCAN HERE TO VIEW OUR PPE RANGE



SCAN HERE TO VIEW COMPATIBLE IMPACT SOCKETS



M18 ONEFIW2FC12 **M18 FUEL** M18 FUEL™ ONE-KEY™ TORQUE-SENSE™ 1/2" CONTROLLED SOLAR COMPACT IMPACT WRENCH WITH FRICTION RING

ONE-KEY
UNLOCKING THE DIGITAL JOBSITE.



- TORQUE-SENSE™ torque control delivers greater torque repeatability than blow counting impact wrenches by utilising proprietary sensors and machine learning algorithms to overcome common job site variability. Customisable torque ranges from 67 to 203 Nm

M18 ONEFIW2FC12-0X

Kit included	No batteries supplied, No charger supplied, HD Box
Article Number	4933493412
EAN Code	4058546482831

M18 FHIWF1R **M18 FUEL** M18 FUEL™ 1" RAILWAY IMPACT WRENCH WITH FRICTION RING



- The M18 FUEL™ 1" railway impact wrench with 2000 Nm of maximum torque has the power to replace petrol solutions
- With a weight of only 6.1 kg it allows fatigue free working even over long periods of time
- Three different speed settings ensure that work can always be done at the optimum speed
- The auto shut-off function integrated in mode 4 prevents over tightening of bolts

M18 FHIWF1R-0C

Kit included	No batteries supplied, No charger supplied, Kitbox
Article Number	4933493140
EAN Code	4058546480110

M18 ONEFHIWF1D **M18 FUEL** M18 FUEL™ ONE-KEY™ 1" HIGH TORQUE D-HANDLE IMPACT WRENCH WITH FRICTION RING AND EXTENDED ANVIL

ONE-KEY
UNLOCKING THE DIGITAL JOBSITE.



- The M18 FUEL™ D-handle high torque impact wrench with a 150 mm extended anvil delivers 2576 Nm of fastening torque replacing AC, petrol or pneumatic solutions
- Delivers up to 2711 Nm of nut-busting torque that enables bolts up to M42 to be unfastened
- The 4 -Mode DRIVE CONTROL allows the user to shift into four different speed and torque settings to maximise application versatility

M18 ONEFHIWF1D-0C

M18 ONEFHIWF1D-121C

Kit included	No batteries supplied, No charger supplied, Kitbox	1 x M18 FB12 Battery pack, M12-18 FC Charger, Kitbox
Article Number	4933471755	4933499251
EAN Code	4058546296544	4058546564155

M18 ONEFHIWF1DS **M18 FUEL** M18 FUEL™ ONE-KEY™ 1" HIGH TORQUE D-HANDLE IMPACT WRENCH WITH FRICTION RING AND SHORT ANVIL

ONE-KEY
UNLOCKING THE DIGITAL JOBSITE.



- The M18 FUEL™ D-handle high torque impact wrench delivers 2576 Nm of fastening torque replacing AC, petrol or pneumatic solutions
- Delivers up to 2711 Nm of nut-busting torque that enables bolts up to M42 to be unfastened
- The 4 -Mode DRIVE CONTROL allows the user to shift into four different speed and torque settings to maximise application versatility

M18 ONEFHIWF1DS-0C

M18 ONEFHIWF1DS-121C

Kit included	No batteries supplied, No charger supplied, Kitbox	1 x M18 FB12 Battery pack, M12-18 FC Charger, Kitbox
Article Number	4933472071	4933499253
EAN Code	4058546324674	4058546564179

M18 ONEFHIWF1 **M18 FUEL** M18 FUEL™ ONE-KEY™ 1" HIGH TORQUE IMPACT WRENCH WITH FRICTION RING

ONE-KEY
UNLOCKING THE DIGITAL JOBSITE.



- The M18 FUEL™ 1" T-handle high torque impact wrench has the power to replace AC, petrol or pneumatic solutions
- Delivering up to 2033 Nm of fastening torque at half the size and weight of AC, petrol or pneumatic solutions
- Packed with 2400 Nm of nut busting torque meaning those rusted stubborn old bolts wont stand a chance

M18 ONEFHIWF1-0X

M18 ONEFHIWF1-802X

Kit included	No batteries supplied, No charger supplied, HD Box	2 x M18 FB8 Battery packs, M12-18 FC Charger, HD Box
Article Number	4933459732	4933459254
EAN Code	4058546029043	4058546564186

M18 ONEFHIWF34 **M18 FUEL** M18 FUEL™ ONE-KEY™ 3/4" HIGH TORQUE IMPACT WRENCH WITH FRICTION RING

ONE-KEY
UNLOCKING THE DIGITAL JOBSITE.



- The M18 FUEL™ high torque impact wrench with ONE-KEY™ technology delivers 1627 Nm of fastening torque in a compact size of 213 mm, which gives more access in tight spaces
- The 4 -Mode DRIVE CONTROL allows the user to shift into four different speed and torque settings to maximise application versatility

M18 ONEFHIWF34-0X

M18 ONEFHIWF34-502X

Kit included	No batteries supplied, No charger supplied, HD Box	2 x M18 B5 Battery packs, M12-18 FC Charger, HD Box
Article Number	4933459729	4933459730
EAN Code	4058546029012	4058546029029

M18 ONEFHIWF12 **M18 FUEL** M18 FUEL™ ONE-KEY™ 1/2" HIGH TORQUE IMPACT WRENCH WITH FRICTION RING

ONE-KEY
UNLOCKING THE DIGITAL JOBSITE.



- The M18 FUEL™ high torque impact wrench with ONE-KEY™ technology delivers 1356 Nm of fastening torque in a compact size of 213 mm, which gives more access in tight spaces
- The 4 -Mode DRIVE CONTROL allows the user to shift into four different speed and torque settings to maximise application versatility

M18 ONEFHIWF12-0X

M18 ONEFHIWF12-502X

Kit included	No batteries supplied, No charger supplied, HD Box	2 x M18 B5 Battery packs, M12-18 FC Charger, HD Box
Article Number	4933459726	4933459727
EAN Code	4058546028985	4058546028992

M18 ONEFHIWF12E **M18 FUEL** M18 FUEL™ ONE-KEY™ 1/2" HIGH TORQUE IMPACT WRENCH WITH FRICTION RING AND EXTENDED ANVIL

ONE-KEY
UNLOCKING THE DIGITAL JOBSITE.



- The M18 FUEL™ extended anvil high torque impact wrench with ONE - KEY™ technology delivering 1017 Nm of fastening torque with a 75 mm extended 1/2" anvil friction ring reception
- The 4 -Mode DRIVE CONTROL allows the user to shift into four different speed and torque settings to maximise application versatility
- The M18 FUEL™ extended anvil high torque impact wrench with ONE - KEY™ technology delivers 1500 Nm of nut busting torque

M18 ONEFHIWF12E-0X

Kit included	No batteries supplied, No charger supplied, HD Box
Article Number	4933478405
EAN Code	4058546345969

M18 ONEFHIWP12 **M18 FUEL™ ONE-KEY™ 1/2" HIGH TORQUE IMPACT WRENCH WITH PIN DETENT**



- The M18 FUEL™ high torque impact wrench with ONE-KEY™ technology delivers 1017 Nm of fastening torque in a compact size of 206 mm, which gives more access in tight spaces
- The 4 -Mode DRIVE CONTROL allows the user to shift into four different speed and torque settings to maximise application versatility

	M18 ONEFHIWP12-0X	M18 ONEFHIWP12-502X
Kit included	No batteries supplied, No charger supplied, HD Box	2 x M18 B5 Battery packs, M12-18 FC Charger, HD Box
Article Number	4933459724	4933459725
EAN Code	4058546028961	4058546028978

M18 ONEFHIWH716 **M18 FUEL™ 7/16" HEX UTILITY HIGH TORQUE IMPACT WRENCH WITH ONE-KEY™**



- Our MILWAUKEE® M18 FUEL™ 7/16" hex utility high torque impact wrench with ONE-KEY™ is the perfect match for our 7/16" accessories range giving you the power when needed in larger wood application
- With up to 1017 Nm max torque, this battery powered impact wrench gives you more power to effortlessly complete your applications or the removal of rusted and corroded hardware

	M18 ONEFHIWH716-0X
Kit included	No batteries supplied, No charger supplied, HD Box
Article Number	4933479152
EAN Code	4058546369460

M18 FHIW2F12 **M18 FUEL™ 1/2" HIGH TORQUE IMPACT WRENCH WITH FRICTION RING**



- Great power density: the M18 FUEL™ high torque impact wrench delivers 1491 Nm fastening torque and 2034 Nm of nut-busting torque in a compact size of 193 mm, which gives more access in tight spaces
- 2000 RPMs of no load speed to perform your task 35% faster than with the previous gen
- Our battery isolation system provides a secure battery connection and controls vibration transmitted to the pack

	M18 FHIW2F12-0X	M18 FHIW2F12-502X
Kit included	No batteries supplied, No charger supplied, HD Box	2 x M18 B5 Battery packs, M12-18 FC Charger, HD Box
Article Number	4933492782	4933492783
EAN Code	4058546476533	4058546476540

M18 FHIW2P12 **M18 FUEL™ 1/2" HIGH TORQUE IMPACT WRENCH WITH PIN DETENT**



- Great power density: the M18 FUEL™ high torque impact wrench delivers 1220 Nm fastening torque and 1491 Nm of nut-busting torque in a compact size of 185 mm, which gives more access in tight spaces
- 2000 RPMs of no load speed to perform your task 35% faster than with the previous gen
- Our battery isolation system provides a secure battery connection and controls vibration transmitted to the pack

	M18 FHIW2P12-0X	M18 FHIW2P12-502X
Kit included	No batteries supplied, No charger supplied, HD Box	2 x M18 B5 Battery packs, M12-18 FC Charger, HD Box
Article Number	4933492785	4933492786
EAN Code	4058546476564	4058546476571

M18 FMTIW2F12 **M18 FUEL™ 1/2" MID-TORQUE IMPACT WRENCH WITH FRICTION RING**



- Most versatile cordless impact wrench in the MILWAUKEE® impressive arsenal with an industry-leading performance at 881 Nm of nut-busting torque and 745 Nm of fastening torque
- Incredibly compact design for this performance level, with only 152 mm overall length ideal for applications in tight spaces

	M18 FMTIW2F12-0X	M18 FMTIW2F12-502X
Kit included	No batteries supplied, No charger supplied, HD Box	2 x M18 B5 Battery packs, M12-18 FC Charger, HD Box
Article Number	4933478449	4933478450
EAN Code	4058546346409	4058546346416

M18 FMTIW2P12 **M18 FUEL™ 1/2" MID-TORQUE IMPACT WRENCH WITH PIN DETENT**



- Most versatile cordless impact wrench in the MILWAUKEE® impressive arsenal with an industry-leading performance at 881 Nm of nut-busting torque and 745 Nm of fastening torque
- Incredibly compact design for this performance level, with only 152 mm overall length ideal for applications in tight spaces

	M18 FMTIW2P12-0X	M18 FMTIW2P12-502X
Kit included	No batteries supplied, No charger supplied, HD Box	2 x M18 B5 Battery packs, M12-18 FC Charger, HD Box
Article Number	4933478452	4933478453
EAN Code	4058546346430	4058546346447

M18 FMTIW2F38 **M18 FUEL™ 3/8" MID TORQUE IMPACT WRENCH WITH FRICTION RING**



- Most versatile cordless impact wrench in the MILWAUKEE® impressive arsenal with an industry-leading performance at 813 Nm of nut-busting torque and 745 Nm of fastening torque
- Incredibly compact design for this performance level, with only 152 mm overall length ideal for applications in tight spaces

	M18 FMTIW2F38-0X
Kit included	No batteries supplied, No charger supplied, HD Box
Article Number	4933479153
EAN Code	4058546369477

M18 ONEIWF12 **M18 FUEL™ ONE-KEY™ 1/2" IMPACT WRENCH WITH FRICTION RING**



- M18 FWF12 but with ONE-KEY™ technology
- Connect via Bluetooth® with the ONE-KEY™ app
- Complete tool customisation via ONE-KEY™ app to tune the tool to your needs
- Control speed, torque, start - end speeds and LED light
- Configure to any application choosing optimum tool settings for repeatable precision
- Program / save profiles for unmatched control

	M18 ONEIWF12-0X	M18 ONEIWF12-502X
Kit included	No batteries supplied, No charger supplied, HD Box	2 x M18 B5 Battery packs, M12-18 FC Charger, HD Box
Article Number	4933459198	4933451374
EAN Code	4002395289936	4002395160525

M18 ONEIWP12

M18 FUEL

M18 FUEL™ ONE-KEY™ 1/2" IMPACT WRENCH WITH PIN DETENT

ONE-KEY
UNLOCKING THE DIGITAL JOBSITE.



- M18 FIWP12 but with ONE-KEY™ technology
- Connect via Bluetooth® with the ONE-KEY™ app
- Complete tool customisation via ONE-KEY™ app to tune the tool to your needs
- Control speed, torque, start and end speeds and LED
- Configure to any application choosing optimum tool settings for repeatable precision
- Program/save profiles for unmatched control

M18 ONEIWP12-0

Kit included	No batteries supplied, No charger supplied, No kitbox or bag supplied
Article Number	4933451152
EAN Code	4002395138210

M18 FIW2F12

M18 FUEL

M18 FUEL™ 1/2" COMPACT IMPACT WRENCH WITH FRICTION RING



- Power efficiency under load - outstanding torque of 339 Nm
- Extremely compact design - total length of just 124 mm for access into tight spaces
- 4-Mode DRIVE CONTROL allows the user to shift into four different speed and torque settings to maximise application versatility
- Bolt removal control delivers full torque output, then decreases RPMs once the bolt is loosened to prevent fastener drops

M18 FIW2F12-0X

M18 FIW2F12-502X

Kit included	No batteries supplied, No charger supplied, HD Box	No batteries supplied, No charger supplied, HD Box
Article Number	4933478443	4933478444
EAN Code	4058546346348	4058546346355

M18 FIW2P12

M18 FUEL

M18 FUEL™ 1/2" COMPACT IMPACT WRENCH WITH PIN DETENT



- Power efficiency under load - outstanding torque of 339 Nm
- Extremely compact design - total length of just 124 mm for access into tight spaces
- 4-Mode DRIVE CONTROL allows the user to shift into four different speed and torque settings to maximise application versatility
- Bolt removal control delivers full torque output, then decreases RPMs once the bolt is loosened to prevent fastener drops

M18 FIW2P12-0X

M18 FIW2P12-502X

Kit included	No batteries supplied, No charger supplied, HD Box	2 x M18 B5 Battery packs, M12-18 FC Charger, HD Box
Article Number	4933478446	4933478447
EAN Code	4058546346379	4058546346386

M18 FIW2F38

M18 FUEL

M18 FUEL™ 3/8" COMPACT IMPACT WRENCH WITH FRICTION RING



- The most compact cordless impact wrench in its class, delivering the most access in tight spaces, with performance at 339 Nm of fastening torque
- Incredibly compact design for this performance level, with only 124 mm overall length ideal for applications in tight spaces
- 4-Mode DRIVE CONTROL allows the user to shift into four different speed and torque settings to maximise application versatility

M18 FIW2F38-0X

Kit included	No batteries supplied, No charger supplied, HD Box
Article Number	4933478650
EAN Code	4058546348434

M18 BLHIWF12

M18

M18™ BRUSHLESS 1/2" HIGH TORQUE IMPACT WRENCH WITH FRICTION RING

BRUSHLESS



- Delivers 1085 Nm of fastening torque and 1627 Nm of nut-busting torque to easily work with most occasional applications
- 222 mm body allows for more access in tight spaces
- Integrated LED light to illuminate the working area
- A speed of 1750 RPM to do your task quickly and efficiently

M18 BLHIWF12-0X

Kit included	No batteries supplied, No charger supplied, HD Box
Article Number	4933492787
EAN Code	4058546476588

M18 BIW12

M18

M18™ 1/2" IMPACT WRENCH



- Compact 1/2" impact wrench measures 155 mm in length making it ideal for working within confined spaces
- High performance 4-pole motor delivers maximum power whilst maximising the power to weight ratio
- REDLINK™ overload protection electronics in tool and battery pack deliver best in class system durability

M18 BIW12-0

M18 BIW12-402C

Kit included	No batteries supplied, No charger supplied, No kitbox or bag supplied	2 x M18 B4 Battery packs, M12-18 C Charger, Kitbox
Article Number	4933443590	4933443607
EAN Code	4002395003266	4002395003280

M18 BIW38

M18

M18™ 3/8" IMPACT WRENCH



- Compact 3/8" impact wrench measures 152 mm in length making it ideal for working within confined spaces
- REDLINK™ overload protection electronics in tool and battery pack deliver best in class system durability
- Heavy duty full metal gearbox and gears for superior durability and maximum torque
- 3/8" square drive for use with universal sockets

M18 BIW38-0

Kit included	No batteries supplied, No charger supplied, No kitbox or bag supplied
Article Number	4933443600
EAN Code	4002395003273

M18 BRAIW

M18

M18™ 3/8" RIGHT ANGLE IMPACT WRENCH



- Compact right angle impact wrench measures 307 mm in length making it ideal for working within confined spaces
- REDLINK™ overload protection electronics in tool and battery pack deliver best in class system durability
- Full metal gearbox and gears for superior durability and maximum torque
- Compact 53 mm head design

M18 BRAIW-0

Kit included	No batteries supplied, No charger supplied, No kitbox or bag supplied
Article Number	4933447899
EAN Code	4002395006670

M18 ONEFLT **M18 FUEL™ LOCKBOLT TOOL WITH ONE-KEY™**



- The M18 FUEL™ lockbolt tool with ONE-KEY™ is an optimised cordless solution that delivers fast, easy installations while maintaining performance, durability, and size
- 20,000 N of pulling force with a stroke length of 30 mm gives you the power to complete the larger applications effortlessly
- Installs up to 1,200 aluminium 6.4 mm lockbolts with one fully charged M18™ 5.0 Ah battery pack

	M18 ONEFLT-0X	M18 ONEFLT-502X
Kit included	No batteries supplied, No charger supplied, HD Box	2 x M18 B5 Battery packs, M12-18 FC Charger, HD Box
Article Number	4933478637	4933478638
EAN Code	4058546348304	4058546348311

M18 ONEFPRT **M18 FUEL™ RIVET TOOL WITH ONE-KEY™**



- The M18 FUEL™ rivet tool with ONE-KEY™ is an optimised cordless solution that delivers fast, easy riveting while maintaining performance, durability, and size
- Pulls up to 900 rivets with a rivet size of 4.8 mm in aluminium or 500 rivets with a size of 6.4 mm in aluminium on a fully charged M18™ 2.0 Ah battery pack

	M18 ONEFPRT-0X	M18 ONEFPRT-202X
Kit included	No batteries supplied, No charger supplied, HD Box	2 x M18 B2 Battery packs, M12-18 FC Charger, HD Box
Article Number	4933478601	4933478602
EAN Code	4058546347949	4058546347956

C18 PCG/600 **M18™ CAULK GUN WITH 600 ML TUBE**



- Up to 4500 N of force. Min 40% higher than previous MILWAUKEE® caulk gun
- REDLINK™ overload protection electronics in tool and battery pack deliver best in class system durability
- Optimised performance with all adhesives and cool temperatures
- Anti-drip feature prevents unwanted dripping when trigger is released

	C18 PCG/600A-201B	C18 PCG/600T-201B
Kit included	1 x M18 B2 Battery pack, M12-18 C Charger, Tool bag	1 x M18 B2 Battery pack, M12-18 C Charger, Tool bag
Article Number	4933441305	4933441808
EAN Code	4002395001422	4002395002375

C18 PCG/400 **M18™ CAULK GUN WITH 400 ML TUBE**



- Up to 4500N of force. Min 40% higher than previous MILWAUKEE® caulk gun
- REDLINK™ overload protection electronics in tool and battery pack deliver best in class system durability
- Optimised performance with all adhesives and cool temperatures
- Anti-drip feature prevents unwanted dripping when trigger is released

	C18 PCG/400T-201B
Kit included	1 x M18 B2 Battery pack, M12-18 C Charger, Tool bag
Article Number	4933441812
EAN Code	4002395002368

C18 PCG/310 **M18™ CAULK GUN WITH 310 ML CANISTER**



- Up to 4500 N of force. Min 40% higher than previous MILWAUKEE® caulk gun
- REDLINK™ overload protection electronics in tool and battery pack deliver best in class system durability
- Optimised performance with all adhesives and cool temperatures
- Anti-drip feature prevents unwanted dripping when trigger is released

	C18 PCG/310C-0B	C18 PCG/310C-201B
Kit included	No batteries supplied, No charger supplied, Tool bag	1 x M18 B2 Battery pack, M12-18 C Charger, Tool bag
Article Number	4933499637	4933441310
EAN Code	4058546028091	4002395001439

M18 GG **M18™ GREASE GUN**



- Powerful 18V motor delivers over 690 bar max. operating pressure
- REDLINK™ overload protection electronics in tool and battery pack deliver best in class system durability
- Extreme long run time - dispenses up to 7 cartridges per charge
- Strong handle balance and ergonomics - only 355 mm long and 3.9 kg

	M18 GG-0	M18 GG-201C
Kit included	No batteries supplied, No charger supplied, No kitbox or bag supplied	1 x M18 B2 Battery pack, M12-18 C Charger, Kitbox
Article Number	4933440493	4933440490
EAN Code	4002395000357	4002395000340

M18 HMP700 **M18™ HYDRAULIC MINI PUMP 700 BAR**



- FORCE LOGIC™ hydraulic mini pump powers commonly available single acting 700 bar head attachments
- Compact size allows usage in confined spaces and allows for easy storage
- The pump is equipped with a connection 3/8" thread to fit most common attachments
- The pump keeps pressure level for reliable use on different applications

	M18 HMP700-0	M18 HMP700-501
Kit included	No batteries supplied, No charger supplied, No kitbox or bag supplied	1 x M18 B5 Battery pack, M12-18 FC Charger, No kitbox or bag supplied
Article Number	4933499928	4933493921
EAN Code	4058546510886	4058546510817

M18 ONEFLAG230XPDB **M18 FUEL™ ONE-KEY™ 230 MM BRAKING ANGLE GRINDER WITH PADDLE SWITCH**



- Delivering corded performance similar to a 2200 W grinder
- ONE-KEY™ tool tracking & security offers a free of charge cloud-based tracking network and inventory management platform for your tools. ONE-KEY™ also features a remote locking functionality
- RAPIDSTOP™ for fastest disc brake in less than 3 seconds and best user protection

	M18 ONEFLAG230XPDB-0C	M18 ONEFLAG230XPDB-122C
Kit included	No batteries supplied, No charger supplied, Kitbox	2 x M18 FB12 Battery packs, M12-18 FC Charger, Kitbox
Article Number	4933478782	4933499242
EAN Code	4058546360641	4058546564063

GET THE RIGHT ANGLE GRINDER FOR THE JOB

1 HIGH OUTPUT™ designed for the heavy applications, from beveling to cleaning up welds



2 Flat gear head design allows working within acute angles down to 42°



3 Variable speed. Maximum control, ideal for working with stainless steel and aluminium, and for rust and paint removal



4 Angle grinders that provide best handling and perfect for surface preparation



	Platform	Technology	Feature	ONE-KEY™	No load speed (rpm)	Disc diameter (mm)	Weight with battery pack (EPTA) (kg)	Switch type	Brake	Anti-kickback protection	FIXTEC™	Line lock out function
1.	M18 ONEFLAG230XPDB-122C	M18 FUEL™	RAPIDSTOP™	ONE-KEY™	6600	230	5.4 (M18 FB12)	Paddle (Deadman) switch	Yes	Yes	Yes	Yes
1.	M18 FLAG230XPDB-121C	M18 FUEL™	-	-	6600	230	5.3 (M18 FB12)	Paddle (Deadman) switch	Yes	Yes	Yes	Yes
1.	M18 FHSAG0180VXPDB2-0X	M18 FUEL™	RAPIDSTOP™	ONE-KEY™	5000 - 8400	180	3.6 (M18 FB8)	Paddle (Deadman) switch	Yes	Yes	Yes	Yes
1.	M18 FHSAG150XPDB2-0X	M18 FUEL™	RAPIDSTOP™	-	9000	150	3.5 (M18 FB8)	Paddle (Deadman) switch	Yes	Yes	Yes	Yes
1.	M18 FHSAG150XB2-0X	M18 FUEL™	RAPIDSTOP™	-	9000	150	3.5 (M18 FB8)	Slide lock-on switch	Yes	Yes	Yes	Yes
1.	M18 FHSAG125XPDB2-802X	M18 FUEL™	RAPIDSTOP™	-	9000	125	3.5 (M18 FB8)	Paddle (Deadman) switch	Yes	Yes	Yes	Yes
1.	M18 FHSAG125XB2-802X	M18 FUEL™	RAPIDSTOP™	-	9000	125	3.5 (M18 FB8)	Slide lock-on switch	Yes	Yes	Yes	Yes
2.	M18 FSAGF125XPDB-0X	M18 FUEL™	RAPIDSTOP™	-	8500	125	2.6 (M18 B5)	Paddle (Deadman) switch	Yes	Yes	Yes	Yes
2.	M18 FSAGF125XB-0X	M18 FUEL™	RAPIDSTOP™	-	8500	125	2.6 (M18 B5)	Slide lock-on switch	Yes	Yes	Yes	Yes
3.	M18 FSAGS0125X-502X	M18 FUEL™	RAPIDSTOP™	ONE-KEY™	3500 - 8500	125	3.0 (M18 B5)	Deadman switch	Yes	Yes	Yes	Yes
3.	M18 FHSAG0125VXPDB2-802X	M18 FUEL™	RAPIDSTOP™	ONE-KEY™	3500 - 9000	125	3.5 (M18 FB8)	Paddle (Deadman) switch	Yes	Yes	Yes	Yes
3.	M18 FSAGV125XPDB-0X	M18 FUEL™	RAPIDSTOP™	-	3500 - 8500	125	2.7 (M18 B5)	Paddle (Deadman) switch	Yes	Yes	Yes	Yes
3.	M18 FSAGV125XB-0X	M18 FUEL™	RAPIDSTOP™	-	3500 - 8500	125	2.7 (M18 B5)	Slide lock-on switch	Yes	Yes	Yes	Yes
4.	M18 ONEFSAG125XPDB-802X	M18 FUEL™	RAPIDSTOP™	ONE-KEY™	8500	125	3.1 (M18 HB8)	Paddle (Deadman) switch	Yes	Yes	Yes	Yes
4.	M18 ONEFSAG125XB-0X	M18 FUEL™	RAPIDSTOP™	ONE-KEY™	8500	125	2.7 (M18 B5)	Slide lock-on switch	Yes	Yes	Yes	Yes
4.	M18 FSAG125X-502X	M18 FUEL™	RAPIDSTOP™	-	8500	125	2.7 (M18 B5)	Slide lock-on switch	Yes	Yes	Yes	Yes
4.	M18 FSAG125X-0X	M18 FUEL™	-	-	8500	125	2.7 (M18 B5)	Slide lock-on switch	No	Yes	Yes	Yes
4.	M18 BLSAG125X-402X	M18™	Brushless	-	11,000	125	2.4 (M18 B4)	Slide lock-on switch	No	Yes	Yes	Yes
4.	M18 BLSAG125XPD-402X	M18™	Brushless	-	11,000	125	2.4 (M18 B4)	Paddle (Deadman) switch	No	Yes	Yes	Yes
4.	M18 BLSAG115XPD-402X	M18™	Brushless	-	11,000	115	2.4 (M18B4)	Paddle (Deadman) switch	No	Yes	Yes	Yes



SCAN HERE TO VIEW OUR PPE RANGE



SCAN HERE TO VIEW COMPATIBLE CUTTING DISCS



M18 FLAG230XPDB **M18 FUEL**
M18 FUEL™ 230 MM LARGE BRAKING GRINDER WITH PADDLE SWITCH



- The world's first single 18V battery operated large angle grinder that delivers the power to grind, lighter than corded tools and makes up to 68 cuts per charge in 42 mm stainless steel pipe

	M18 FLAG230XPDB-0C	M18 FLAG230XPDB-121C
Kit included	No batteries supplied, No charger supplied, Kitbox	1 x M18 FB12 Battery pack, M12-18 FC Charger, Kitbox
Article Number	4933464114	4933499241
EAN Code	4058546220594	4058546564056

M18 FHSAGO180VXPDB2 **M18 FUEL**
M18 FUEL™ HIGH PERFORMANCE 180 MM BRAKING GRINDER WITH VARIABLE SPEED & ONE-KEY™ GEN 2



- M18™ High Performance 180 mm small angle grinder, delivering corded performance similar to a 1800 W grinder
- Maximum control for every application with 4-mode push button, ideal for working with stainless steel and aluminium & for rust and paint removal
- RAPIDSTOP™ for fastest disc brake in less than 3 seconds and best user protection

	M18 FHSAGO180VXPDB2-0X
Kit included	No batteries supplied, No charger supplied, HD Box
Article Number	4933498942
EAN Code	4058546528119

M18 FHSAG150XPDB2 **M18 FUEL**
M18 FUEL™ HIGH PERFORMANCE 150 MM BRAKING GRINDER WITH PADDLE SWITCH



- M18™ High Performance 150 mm small angle grinder, delivering corded performance similar to a 1800 W grinder
- RAPIDSTOP™ for fastest disc brake in less than 2 seconds and best user protection
- Increased performance while reducing the housing around the motor for better balance & ergonomics compared to previous model
- Anti-vibration side handle for lower vibration

	M18 FHSAG150XPDB2-0X
Kit included	No batteries supplied, No charger supplied, HD Box
Article Number	4933493422
EAN Code	4058546482930

M18 FHSAG150XB2 **M18 FUEL**
M18 FUEL™ HIGH PERFORMANCE 150 MM BRAKING GRINDER WITH SLIDE SWITCH



- M18™ High Performance 150 mm small angle grinder, delivering corded performance similar to a 1800 W grinder
- RAPIDSTOP™ for fastest disc brake in less than 2 seconds and best user protection
- Increased performance while reducing the housing around the motor for better balance & ergonomics compared to previous model
- Anti-vibration side handle for lower vibration

	M18 FHSAG150XB2-0X
Kit included	No batteries supplied, No charger supplied, HD Box
Article Number	4933493421
EAN Code	4058546482923

M18 FHSAG125XPDB2 **M18 FUEL**
M18 FUEL™ HIGH PERFORMANCE 125 MM BRAKING GRINDER WITH PADDLE SWITCH



- M18™ High Performance 125 mm small angle grinder, delivering corded performance similar to a 1800 W grinder
- RAPIDSTOP™ for fastest disc brake in less than 2 seconds and best user protection
- Increased performance while reducing the housing around the motor for better balance & ergonomics compared to previous model
- Anti-vibration side handle for lower vibration

	M18 FHSAG125XPDB2-0X	M18 FHSAG125XPDB2-802X
Kit included	No batteries supplied, No charger supplied, HD Box	2 x M18 FB8 Battery packs, M12-18 FC Charger, HD Box
Article Number	4933493417	4933493418
EAN Code	4058546482886	4058546482893

M18 FHSAG125XB2 **M18 FUEL**
M18 FUEL™ HIGH PERFORMANCE 125 MM BRAKING GRINDER WITH SLIDE SWITCH



- M18™ High Performance 125 mm small angle grinder, delivering corded performance similar to a 1800 W grinder
- RAPIDSTOP™ for fastest disc brake in less than 2 seconds and best user protection
- Increased performance while reducing the housing around the motor for better balance & ergonomics compared to previous model
- Anti-vibration side handle for lower vibration

	M18 FHSAG125XB2-0X	M18 FHSAG125XB2-802X
Kit included	No batteries supplied, No charger supplied, HD Box	2 x M18 FB8 Battery packs, M12-18 FC Charger, HD Box
Article Number	4933493415	4933493416
EAN Code	4058546482862	4058546482879

M18 FSAGSV0125X **M18 FUEL**
M18 FUEL™ 125 MM SAFETY GRINDER WITH VARIABLE SPEED AND ONE-KEY™



- Dual trigger activation requires the user to have always both hands on the tool and automatically shuts down the tool whenever one hand is taken off
- RAPIDSTOP™ for fastest disc brake in less than 1 second and best user protection
- AUTOSTOP™ shuts down the tool to protect the user in bind-up situations or any unnatural movement

	M18 FSAGSV0125X-0X	M18 FSAGSV0125X-502X
Kit included	No batteries supplied, No charger supplied, HD Box	2 x M18 B5 Battery packs, M12-18 FC Charger, HD Box
Article Number	4933493552	4933493553
EAN Code	4058546484231	4058546484248

M18 FHSAGO125VXPDB2 **M18 FUEL**
M18 FUEL™ HIGH PERFORMANCE 125 MM BRAKING GRINDER WITH VARIABLE SPEED AND ONE-KEY™



- M18™ High Performance 125 mm small angle grinder, delivering corded performance similar to a 1800 W grinder
- Maximum control for every application with 4 - speed mode push button, ideal for working with stainless steel and aluminium & for rust and paint removal
- RAPIDSTOP™ for fastest disc brake in less than 2 seconds and best user protection

	M18 FHSAGO125VXPDB2-0X	M18 FHSAGO125VXPDB2-802X
Kit included	No batteries supplied, No charger supplied, HD Box	2 x M18 FB8 Battery packs, M12-18 FC Charger, HD Box
Article Number	4933493419	4933493420
EAN Code	4058546482909	4058546482916

M18 ONEFSAG125XPDB **M18 FUEL** M18 FUEL™ ONE-KEY™ 125 MM BRAKING ANGLE GRINDER WITH PADDLE SWITCH



- Delivering corded performance similar to a 1200 W grinder
- ONE-KEY™ tool tracking & security offers a free of charge cloud-based tracking network and inventory management platform for your tools. ONE-KEY™ also features a remote locking functionality
- RAPIDSTOP™ for fastest disc brake in less than 2 seconds and best user protection

M18 ONEFSAG125XPDB-0X **M18 ONEFSAG125XPDB-502X**

Kit included	No batteries supplied, No charger supplied, HD Box	2 x M18 B5 Battery packs, M12-18 FC Charger, HD Box
Article Number	4933478434	4933478435
EAN Code	4058546346256	4058546346263

M18 ONEFSAG125XB **M18 FUEL** M18 FUEL™ ONE-KEY™ 125 MM BRAKING ANGLE GRINDER WITH SLIDE SWITCH



- Delivering corded performance similar to a 1200 W grinder
- ONE-KEY™ tool tracking & security offers a free of charge cloud-based tracking network and inventory management platform for your tools. ONE-KEY™ also features a remote locking functionality
- RAPIDSTOP™ for fastest disc brake in less than 2 seconds and best user protection

M18 ONEFSAG125XB-0X

Kit included	No batteries supplied, No charger supplied, HD Box
Article Number	4933478433
EAN Code	4058546346249

M18 FSAG125XB **M18 FUEL** M18 FUEL™ 125 MM BRAKING ANGLE GRINDER WITH SLIDE SWITCH



- Delivering corded performance similar to a 1200 W grinder
- RAPIDSTOP™ for fastest disc brake in less than 2 seconds and best user protection
- Reduced gearhead size and lower angle of battery slot - for better balance & ergonomics compared to previous model
- Anti-vibration side handle for lower vibration
- Integrated FIXTEC™ system for tool-free wheel change

M18 FSAG125XB-0X **M18 FSAG125XB-502X**

Kit included	No batteries supplied, No charger supplied, HD Box	2 x M18 B5 Battery packs, M12-18 FC Charger, HD Box
Article Number	4933478429	4933478430
EAN Code	4058546346201	4058546346218

M18 FSAG125X **M18 FUEL** M18 FUEL™ 125 MM ANGLE GRINDER WITH SLIDE SWITCH



- Delivering corded performance similar to a 1200 W grinder
- Reduced gearhead size and lower angle of battery slot - for better balance & ergonomics compared to previous model
- Anti-vibration side handle for lower vibration
- Integrated FIXTEC™ system for tool-free wheel change
- Slim handle design

M18 FSAG125X-0X

Kit included	No batteries supplied, No charger supplied, HD Box
Article Number	4933478428
EAN Code	4058546346195

M18 FSAGV125XPDB **M18 FUEL** M18 FUEL™ 125 MM VARIABLE SPEED & BRAKING ANGLE GRINDER WITH PADDLE SWITCH



- Maximum control for every application - 5-step speed dial ideal for working with stainless steel and aluminium & for rust and paint removal
- Delivering corded performance similar to a 1200 W grinder
- RAPIDSTOP™ for fastest disc brake in less than 2 seconds and best user protection
- Non-lockable safety paddle switch with line-lock-out function to prevent automatic start up
- Anti-vibration side handle for lower vibration

M18 FSAGV125XPDB-0X

Kit included	No batteries supplied, No charger supplied, HD Box
Article Number	4933478437
EAN Code	4058546346287

M18 FSAGV125XB **M18 FUEL** M18 FUEL™ 125 MM VARIABLE SPEED & BRAKING ANGLE GRINDER WITH SLIDE SWITCH



- Maximum control for every application - 5-step speed dial ideal for working with stainless steel and aluminium & for rust and paint removal
- Delivering corded performance similar to a 1200 W grinder
- RAPIDSTOP™ for fastest disc brake in less than 2 seconds and best user protection
- Anti-vibration side handle for lower vibration
- Integrated FIXTEC™ system for tool-free wheel change

M18 FSAGV125XB-0X

Kit included	No batteries supplied, No charger supplied, HD Box
Article Number	4933478436
EAN Code	4058546346270

M18 FSAGF125XPDB **M18 FUEL** M18 FUEL™ 125 MM FLATHEAD BRAKING ANGLE GRINDER WITH PADDLE SWITCH



- Flat gear head design - allows user working within acute angles down to 42°
- Delivering corded performance similar to a 1200 W grinder
- RAPIDSTOP™ for fastest disc brake in less than 2 seconds and best user protection
- Non-lockable safety paddle switch with line-lock-out function to prevent automatic start up
- Anti-vibration side handle for lower vibration
- FIXTEC™ nut for tool-free wheel change

M18 FSAGF125XPDB-0X

Kit included	No batteries supplied, No charger supplied, HD Box
Article Number	4933478439
EAN Code	4058546346300

M18 FSAGF125XB **M18 FUEL** M18 FUEL™ 125 MM FLATHEAD BRAKING ANGLE GRINDER WITH SLIDE SWITCH



- Flat gear head design - allows user working within acute angles down to 42°
- Delivering corded performance similar to a 1200 W grinder
- RAPIDSTOP™ for fastest disc brake in less than 2 seconds and best user protection
- Anti-vibration side handle for lower vibration
- FIXTEC™ nut for tool-free wheel change
- Slim handle design

M18 FSAGF125XB-0X

Kit included	No batteries supplied, No charger supplied, HD Box
Article Number	4933478438
EAN Code	4058546346294

M18 BLSAG125X M18 BRUSHLESS 125 MM ANGLE GRINDER WITH SLIDE SWITCH

M18

BRUSHLESS



- 11,000 RPM optimised for cutting applications
- Powerful brushless motor delivering corded performance similar to a 800 W grinder
- Most compact and lightest cordless angle grinder in the the range
- Safety clutch protects user the from kickback injuries
- Integrated FIXTEC™ system for tool-free wheel change

	M18 BLSAG125X-0	M18 BLSAG125X-402X
Kit included	No batteries supplied, No charger supplied, No kitbox or bag supplied	2 x M18 B4 Battery packs, M12-18 C Charger, HD Box
Article Number	4933492643	4933492644
EAN Code	4058546413934	4058546413941

M18 BLSAG125XPD M18 BRUSHLESS 125 MM ANGLE GRINDER WITH PADDLE SWITCH

M18

BRUSHLESS



- 11,000 RPM optimised for cutting applications
- Powerful brushless motor delivering corded performance similar to a 800 W grinder
- Most compact and lightest cordless angle grinder in the the range
- Safety clutch protects user the from kickback injuries
- Integrated FIXTEC™ system for tool-free wheel change

	M18 BLSAG125XPD-0	M18 BLSAG125XPD-402X
Kit included	No batteries supplied, No charger supplied, No kitbox or bag supplied	2 x M18 B4 Battery packs, M12-18 C Charger, HD Box
Article Number	4933492645	4933492646
EAN Code	4058546413958	4058546413965

M18 BLSAG115XPD M18 BRUSHLESS 115 MM ANGLE GRINDER WITH PADDLE SWITCH

M18

BRUSHLESS



- 11,000 RPM optimised for cutting applications
- Powerful brushless motor delivering corded performance similar to a 800 W grinder
- Most compact and lightest cordless angle grinder in the the range
- Safety clutch protects user the from kickback injuries
- Integrated FIXTEC™ system for tool-free wheel change

	M18 BLSAG115XPD-0
Kit included	No batteries supplied, No charger supplied, No kitbox or bag supplied
Article Number	4933492647
EAN Code	4058546413972

M18 FROP21 M18 FUEL™ RANDOM ORBITAL POLISHER WITH 21 MM STROKE

M18 FUEL



- Delivering equal performance as corded random orbital polishers to complete polishing and heavy-correction applications
- 8 position speed dial selection for maximum control and best finishing results
- 21 mm orbital function for fast and efficient polishing with a free hologram finish
- Large ergonomic front grip area with overmold for easy and comfortable handling, especially when working with the tool vertically

	M18 FROP21-0X	M18 FROP21-502X
Standard equipment	150 mm backing pad, dust screen	150 mm backing pad, dust screen
Kit included	No batteries supplied, No charger supplied, HD Box	2 x M18 B5 Battery packs, M12-18 FC Charger, HD Box
Article Number	4933478836	4933478837
EAN Code	4058546361181	4058546361198

M18 FROP15 M18 FUEL™ RANDOM ORBITAL POLISHER WITH 15 MM STROKE

M18 FUEL



- Delivering equal performance as corded random orbital polishers to complete polishing and heavy-correction applications
- 8 position speed dial selection for maximum control and best finishing results
- 15 mm orbital function for fast and efficient polishing with a free hologram finish
- Large ergonomic front grip area with overmold for easy and comfortable handling, especially when working with the tool vertically

	M18 FROP15-0X	M18 FROP15-502X	M18 FROP15-502X KIT
Standard equipment	125 mm backing pad, dust screen	125 mm backing pad, dust screen	125 mm backing pad, dust screen, 140 mm red sponge (hard), 140 mm yellow sponge (medium), red cloth, heavy compound, medium compound
Kit included	No batteries supplied, 2 x M18 B5 Battery packs, M12-18 FC Charger, HD Box	No charger supplied, 2 x M18 B5 Battery packs, M12-18 FC Charger, HD Box	2 x M18 B5 Battery packs, M12-18 FC Charger, HD Box
Article Number	4933478834	4933478835	4933492352
EAN Code	4058546361167	4058546361174	4058546417192

M18 FAP M18 FUEL™ POLISHER

M18 FUEL



- Cordless polisher with 8 position variable speed selection ranging from 360 - 2200 rpm
- Outstanding run time to polish one full size car per battery charge (on moderate to good paint, light scratches)
- Maximum polishing accessory diameter of 180 mm
- Constant speed electronics with soft start for smooth start up

	M18 FAP180-0	M18 FAP180-502X
Standard equipment	Polishing backing pad, dust screen, bale handle, AVS side handle	Polishing backing pad, polishing sponge white, polishing sponge orange, lambswool, dust screen, bale handle, AVS side handle
Kit included	No batteries supplied, No charger supplied, No kitbox or bag supplied	2 x M18 B5 Battery packs, M12-18 FC Charger, HD Box
Article Number	4933451549	4933451550
EAN Code	4002395144518	4002395144525

M18 FMCS66 M18 FUEL™ 66 MM METAL CIRCULAR SAW

M18 FUEL



- First 18V cordless metal circular saw with 66 mm cutting depth and 1800 W corded performance
- Faster cutting speed compared to corded unit
- Shoe designed to connect directly on MILWAUKEE® guide rail (sold separately). This allows the user to make straight and accurate cuts with minimum setup time
- Performance light indicates when the device is pushed to hard

	M18 FMCS66-0C	M18 FMCS66-802C
Kit included	No batteries supplied, No charger supplied, Kitbox	2 x M18 FB8 Battery packs, M12-18 FC Charger, Kitbox
Article Number	4933472110	4933499243
EAN Code	4058546325060	4058546564070

M18 FMCS M18 FUEL™ 57 MM METAL CIRCULAR SAW

M18 FUEL



- Dry-cutting technology provides cold, fast and burr-free metal cutting
- Tool-free depth adjustment, quickly and easily adjusts cutting depth from 0 to 57 mm
- Compact and light weight design for most comfortable use
- Dual-action trigger prevents any accidental start up
- Tool-free cutting depth adjustment and plunge lever for fast and effective plunge cuts

	M18 FMCS-0X	M18 FMCS-502X
Kit included	No batteries supplied, No charger supplied, HD Box	2 x M18 B5 Battery packs, M12-18 FC Charger, HD Box
Article Number	4933459192	4933459193
EAN Code	4002395289271	4002395289288

M18 FBS127

M18 FUEL™ DEEP CUT BAND SAW GEN 2

M18 FUEL



- Fastest cutting band saw in it's class and 30% faster than previous model
- Optimised ergonomics and weight reduced by 1.4 kg compared to previous model
- Maximum control for any material, 4-step speed mode & variable speed trigger; ideal for working with stainless steel and aluminium
- Cut-stop technology, the tool shuts off automatically after the cut for increased user safety

	M18 FBS127-0	M18 FBS127-502C
Kit included	No batteries supplied, No charger supplied, Kitbox/No kitbox or bag supplied	2 x M18 B5 Battery packs, M12-18 FC Charger, Kitbox
Article Number	4933498309	4933498310
EAN Code	4058546521783	4058546521790

M18 FBS85

M18 FUEL™ COMPACT BAND SAW

M18 FUEL



- 20% faster cutting compared to previous model
- Large cutting capacity up to a diameter of 85 mm
- Variable speed trigger for quick & easy speed adjustments
- Band saw cover protects user from injuries by preventing any access to the blade - tool-free installation and removal within seconds

	M18 FBS85-0C	M18 FBS85-202C
Kit included	No batteries supplied, No charger supplied, Kitbox	2 x M18 B2 Battery packs, M12-18 FC Charger, Kitbox
Article Number	4933471496	4933471497
EAN Code	4058546293956	4058546293963

M18 FDGROVB

M18 FUEL™ BRAKING DIE GRINDER WITH ONE-KEY™, VARIABLE SPEED AND SLIDE SWITCH

M18 FUEL



- Maximum control for every application, 5-step speed dial ideal for working with stainless steel, carbide burrs & accessories up to 75 mm
- Delivering corded performance similar to a 1200 W grinder
- ONE-KEY™ tool tracking & security offers a free of charge cloud-based tracking network and inventory management platform for your tools. ONE-KEY™ also features a remote locking functionality

	M18 FDGROVB-0X	M18 FDGROVB-502X
Kit included	No batteries supplied, No charger supplied, HD Box	2 x M18 B5 Battery packs, M12-18 FC Charger, HD Box
Article Number	4933480955	4933480956
EAN Code	4058546412401	4058546412418

M18 FMDP

M18 FUEL™ MAGNETIC DRILLING PRESS WITH PERMANENT MAGNET

M18 FUEL



- FUEL™ technology provides corded drilling performance with strongest magnet holding force on 1/4" steel and 40 x 18 mm holes per battery charge
- AUTOSTOP™ lift-off detection: Detects excess rotation and automatically cuts power to the drill for best user protection

	M18 FMDP-0C	M18 FMDP-502C
Kit included	No batteries supplied, No charger supplied, Kitbox	2 x M18 B5 Battery packs, M12-18 FC Charger, Kitbox
Article Number	4933451636	4933451012
EAN Code	4002395142330	4002395136650

M18 FBS127DO

M18 FUEL™ DUAL-TRIGGER DEEP CUT BAND SAW WITH ONE-KEY™

M18 FUEL



- Dual trigger activation, requires the user to have always both hands on the tool and automatically shuts down the tool whenever one hand is taken off
- Maximum control for any material, 4-step speed mode & variable speed trigger; ideal for working with stainless steel and aluminium

	M18 FBS127DO-0C
Kit included	No batteries supplied, No charger supplied, Kitbox
Article Number	4933498311
EAN Code	4058546521806

M18 FDGROVPDB

M18 FUEL™ BRAKING DIE GRINDER WITH ONE-KEY™, VARIABLE SPEED AND PADDLE SWITCH

M18 FUEL



- Maximum control for every application, 5-step speed dial ideal for working with stainless steel, carbide burrs & accessories up to 75 mm
- Delivering corded performance similar to a 1200 W grinder
- ONE-KEY™ tool tracking & security offers a free of charge cloud-based tracking network and inventory management platform for your tools. ONE-KEY™ also features a remote locking functionality

	M18 FDGROVPDB-0X
Kit included	No batteries supplied, No charger supplied, HD Box
Article Number	4933480957
EAN Code	4058546412425

M18 FDGRB

M18 FUEL™ BRAKING DIE GRINDER WITH SLIDE SWITCH

M18 FUEL



- Delivering corded performance similar to a 1200 W grinder
- Spindle lock - increased productivity by reducing the need of 2 wrenches
- RAPIDSTOP™ stops all accessories in under the 2 seconds
- Lower angle of battery slot for better balance & ergonomics compared to previous model
- Universal reception to fit both, 6 and 8 mm accessories

	M18 FDGRB-0	M18 FDGRB-0X	M18 FDGRB-502X
Kit included	No batteries supplied, No charger supplied, No kitbox or bag supplied	No batteries supplied, No charger supplied, HD Box	2 x M18 B5 Battery packs, M12-18 FC Charger, HD Box
Article Number	4933480952	4933480953	4933480954
EAN Code	4058546412371	4058546412388	4058546412395

M18 BMS12

M18™ METAL SHEAR

M18



- Accurate cuts with maximum cutting depth of 1.2 mm in steel
- Unique 360° tool-free rotating head with 12 locking positions to access tight spaces and increasing user comfort
- REDLINK™ overload protection electronics in tool and battery pack deliver best in class system durability
- Individual battery cell monitoring optimises tool run time and ensures long term pack durability

	M18 BMS12-0
Kit included	No batteries supplied, No charger supplied, No kitbox or bag supplied
Article Number	4933447925
EAN Code	4002395006731

M18 BMS20
M18™ METAL SHEAR

M18



- Accurate cuts with maximum cutting depth of 2.0 mm in steel
- Unique 360° tool-free rotating head with 12 locking positions to access tight spaces and increasing user comfort
- REDLINK™ overload protection electronics in tool and battery pack deliver best in class system durability
- Individual battery cell monitoring optimises tool run time and ensures long term pack durability

M18 BMS20-0

Kit included	No batteries supplied, No charger supplied, No kitbox or bag supplied
Article Number	4933447935
EAN Code	4002395006748

M18 BHG
M18™ HEAT GUN

M18



- High performance heat coil allows the tool to reach 470 °C
- Reaches operational temperature in six seconds allowing the user to quickly complete his application
- REDLINK™ overload protection electronics in tool and battery pack deliver best in class system durability
- Individual battery cell monitoring optimises tool run time and ensures long term pack durability

M18 BHG-0

M18 BHG-502C

Kit included	No batteries supplied, No charger supplied, No kitbox or bag supplied	2 x M18 B5 Battery packs, M12-18 C Charger, Kitbox
Article Number	4933459771	4933459772
EAN Code	4058546029432	4058546029449

M18 FMS305
M18 FUEL™ ONE-KEY™ 305 MM MITRE SAW

M18 FUEL



- Delivers the power to cut at the same rate of an equivalent AC 305 mm saw, with the ability to cut up to 500 pieces of 78 mm pine base board on one 12.0 Ah battery charge
- The HIGH OUTPUT™ system of tools elevates the M18 FUEL™ technologies to a new level and delivers extended performance and extended run time. These tools are designed to maximise the partnership with HIGH OUTPUT™ and FORGE™ batteries

M18 FMS305-0

M18 FMS305-121

Kit included	No batteries supplied, No charger supplied, No kitbox or bag supplied	1 x M18 FB12 Battery pack, M12-18 FC Charger, No kitbox or bag supplied
Article Number	4933471205	4933499181
EAN Code	4058546288334	4058546563455

M18 FMS254
M18 FUEL™ 254 MM MITRE SAW

M18 FUEL



- With a 254 mm blade it delivers large and accurate cut capacities
- Up to 430 cuts in 26 mm x 142 mm decking with a 12.0 Ah battery gives the ability to work a full day without recharging the battery
- Quick release bevel setting with detents allows the simple setting of bevel angles to the left and right

M18 FMS254-0

Kit included	No batteries supplied, No charger supplied, No kitbox or bag supplied
Article Number	4933451729
EAN Code	4002395279418

M18 FMS190
M18 FUEL™ 190 MM MITRE SAW

M18 FUEL



- With a 190 mm blade it delivers accurate cut capacities
- Up to 299 cuts in 38 mm 89 mm soft wood with a 5.0 Ah battery gives the ability to work a full day without recharging the battery
- Quick release bevel setting allows the simple setting of bevel angles to the left and right
- Large sliding fences gives maximum support to the material being cut providing stability and accuracy

M18 FMS190-0

Kit included	No batteries supplied, No charger supplied, No kitbox or bag supplied
Article Number	4933459619
EAN Code	4058546027919

MSL 1000
MITRE SAW STAND EXTENDABLE UP TO 2 M



- Light weight aluminium, easy to transport onto the job site
- 1.08 m total length, will fit into most small vans and cars
- Extendable each side - 2.08 m extended
- Will hold up to 180 kg
- One point leg adjustment for leveling on uneven ground
- Quick release brackets
- Height adjustable length stops

MSL 1000

Article Number	4933428970
EAN Code	4002395241729

MSL 2000
MITRE SAW STAND EXTENDABLE UP TO 2.5 M



- Light weight aluminium, easy to transport onto the job site
- 1.09 m total length, will fit into most small vans and cars
- Extendable each side - 2.54 m extended
- Will hold up to 227 kg
- One point leg adjustment for leveling on uneven ground
- Quick release brackets
- Height adjustable length stops

MSL 2000

Article Number	4933459617
EAN Code	4058546027896

MSL 3000
MITRE SAW STAND EXTENDABLE UP TO 3 M



- Lightweight construction and wheel set - provides portability on the jobsite
- Folds down to 1200 mm - thanks to the collapsible legs and compact design
- Extendable up to 3 m - makes it easy to cut large workpieces to length
- Heavy Duty - carries up to 250 kg
- One point leg adjustment for leveling on uneven ground
- Comfortable working height at 81 cm

MSL 3000

Article Number	4933411565
EAN Code	4002395236213

GET THE RIGHT MITRE SAW FOR THE JOB

1 EXTERNAL

Roofing, fencing, decking

CAPACITY



2 INTERNAL

Second fix, smaller cuts, skirting boards, kitchen fitting, door and window surrounds

PORTABILITY



	Platform	ONE-KEY™	No load speed (rpm)	Blade diameter (mm)	Bevel capacity left (°)	Bevel capacity right (°)	Mitre capacity left (°)	Mitre capacity right (°)	Bore size (mm)	Max. cutting capacity at fence 90° mitre / 90° bevel (mm)	Weight with battery pack (EPTA) (kg)	
1.	M18 FMS305-121	M18 FUEL™	ONE-KEY™	3600	305	48	48	55	60	30	96.5 x 340	22.5 (M18 FB12)
1.	M18 FMS254-0	M18 FUEL™	-	4000	254	48	48	50	60	30	91 x 289	20.0 (M18 B5)
2.	M18 FMS190-0	M18 FUEL™	-	5000	190	48	48	48	48	30	-	12.7 (M18 B5)

MITRE SAW EXTENDABLE LEGSTANDS

	Height (mm)	Base size (mm)	Extendable up to (mm)	Collapsed size (mm)	Bearing force (kg)	Weight (kg)
MSL 1000	850	1065	2125	1065	180	17.0
MSL 2000	860	1093	2542	1093	227	14.0
MSL 3000	810	1100	3000	1200	250	23.0
MSUV 280	850	1160	2800	1320	136	27.0



SCAN HERE TO VIEW OUR PPE RANGE



SCAN HERE TO VIEW COMPATIBLE MITRE SAW BLADES



MSUV 280
MITRE SAW STAND EXTENDABLE UP TO 2.8 M

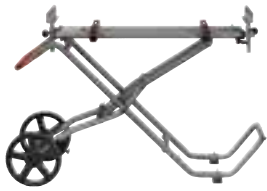

- Upright folding design for easy storage and transportation
- Easy one action foot pedal lock and single lift point allows the stand to be quickly setup with a mitre saw attached
- Universal quick release saw brackets compatible with all MILWAUKEE® mitre saws
- Extra wide work piece support rollers allows larger materials to be more easily handled
- 2.8 m extension width

MSUV 280

Article Number	4933478992
EAN Code	4058546362744

M18 FTS210
M18 FUEL™ ONE-KEY™ TABLE SAW



- The ONE-KEY™ M18 FUEL™ table saw delivers the power to rip cut at the same feed rate of an equivalent AC saw, with the ability to cut 190 m of 19 mm OSB board on one 12.0 Ah battery charge

M18 FTS210-0

M18 FTS210-121B

Kit included	No batteries supplied, No charger supplied, No kitbox or bag supplied	1 x M18 FB12 Battery pack, M12-18 FC Charger, No kitbox or bag supplied
Article Number	4933464722	4933499179
EAN Code	4058546226671	4058546563431

TSS 1000
TABLE SAW STAND



- Light weight of only 6.6 kg - easy to transport onto the job site
- Will hold up to 82 kg
- Quick release bracket to hold the saw firmly in place
- One point leg adjustment for leveling on uneven ground
- Comfortable work height at 559 mm
- To be used with M18 FUEL™ ONE-KEY™ table saw (M18 FTS210)

TSS 1000

Article Number	4933464227
EAN Code	4058546221720

M18 FPS55
M18 FUEL™ 55 MM PLUNGE SAW



- The M18 FUEL™ plunge saw delivers the power to rip cut at the same feed rate of an equivalent AC circular saw - with the ability to cut 45 metres of 18 mm plywood on one 5.5 Ah battery charge
- The depth adjustment has two scales, one for on the rail and one for off the rail, this can easily be adjusted by the press of a button

M18 FPS55-0P

M18 FPS55-552P

Kit included	No batteries supplied, No charger supplied, PACKOUT™ XL tool box	2 x M18 HB5.5 Battery packs, M12-18 FC Charger, PACKOUT™ XL tool box
Article Number	4933478777	4933478778
EAN Code	4058546360597	4058546360603

M18 FCS552
M18 FUEL™ COMPACT CIRCULAR SAW



- The M18 FUEL™ circular saw delivers the power to rip cut at the same feed rate of an equivalent AC circular saw, with the ability to cut 200 pieces of 90 mm x 45 mm pine stud on one 3.0 Ah HIGH OUTPUT™ battery as its optimised for HIGH OUTPUT™ technology
- Magnesium shoe reduces weight and maximises durability
- Durable metal rafter hang hook for work space management and safety

M18 FCS552-0

M18 FCS552-0X

M18 FCS552-302X

Kit included	No batteries supplied, No charger supplied, Gift box	No batteries supplied, No charger supplied, HD Box	2 x M18 HB3 Battery packs, M12-18 FC Charger, HD Box
Article Number	4933493587	4933493588	4933493589
EAN Code	4058546484583	4058546484590	4058546484606

HD18 CS
M18™ 55 MM CIRCULAR SAW FOR WOOD AND PLASTIC



- Powerful 3500 rpm motor easily cuts most timber construction materials
- REDLINK™ overload protection electronics in tool and battery pack deliver best in class system durability
- Large 50° bevel facility
- Magnesium upper guard provide best in class durability for impact resistance
- Excellent visibility of cutting line

HD18 CS-0

HD18 CS-402B

Kit included	No batteries supplied, No charger supplied, No kitbox or bag supplied	2 x M18 B4 Battery packs, M12-18 C Charger, Tool bag
Article Number	4933419134	4933441400
EAN Code	4002395238248	4002395001613

M18 FCSRH662
M18 FUEL™ REAR HANDLE CIRCULAR SAW FOR WOOD GEN 2



- Delivers the power to rip cut at the same feed rate of an equivalent AC circular saw due to the FORGE™ technology built into this saw allows the ability to cross cut up to 700 pieces of 90 mm x 45 mm pine stud on one 12.0 Ah battery
- 190 mm blade which gives a 68 mm depth of cut, enabling the saw to cut 3 stacked OSB boards
- Magnesium shoe reduces weight and maximises durability

M18 FCSRH662-0

Kit included	No batteries supplied, No charger supplied, No kitbox or bag supplied
Article Number	4933498992
EAN Code	4058546528614



GET THE RIGHT SAW FOR THE JOB



1 TABLE, PLUNGE AND CIRCULAR SAWS

	Platform	ONE-KEY™	No load speed (rpm)	Blade diameter (mm)	Bevel capacity (°)	Max. cutting depth 45° (mm)	Max. cutting depth 90° (mm)	Weight with battery pack (EPTA) (kg)
M18 FTS210-121B	M18 FUEL™	ONE-KEY™	6300	210	47	-	63.5	22.3 (M18 FB12)
M18 FPS55-552P	M18 FUEL™	-	2500 - 5600	165	-1 - 48	44	59	4.9 (M18 HB5.5)
M18 FCS552-302X	M18 FUEL™	-	6000	165	50	44	57	3.4 (M18 HB3)
HD18 CS-402B	M18™	-	3500	165	0 - 50	39	55	3.8 (M18 B4)
M18 FCS66GR3-121C	M18 FUEL™	-	6,000	190	50	53	68	5.7 (M18 FB12)
M18 FCSRH662-0	M18 FUEL™	-	6,300	190	57	53	68	5.2 (M18 FB12)
M18 BLCS66-502X	M18™	-	5000	190	0 - 50	48	66	4.0 (M18 B5)
M12 FCS442-502X	M12 FUEL™	-	3850	140	0 - 50	32	46	2.4 (M12 HB5)

2 SAWZALL™, HACKZALL™, JIGSAWS

	Platform	ONE-KEY™	No load stroke rate (spm)	Stroke length (mm)	Weight with battery pack (EPTA) (kg)
M18 FSX-801C	M18 FUEL™	-	0 - 3000	32	5.06 (M18 FB8)
M18 ONEFSZ-502X	M18 FUEL™	ONE-KEY™	0-3000	32	3.8 (M18 B5)
M18 FSZ-502X	M18 FUEL™	-	0-3000	32	3.8 (M18 B5)
M18 BSX-402C	M18™	-	0 - 3000	28.6	4.0 (M18 B4)
M18 FHZ-502X	M18 FUEL™	-	0 - 3000	22	2.6 (M18 B5)
C18 HZ-402B	M18™	-	0 - 3000	20	2.5 (M18 B4)
M18 FBJS-502X	M18 FUEL™	-	800 - 3500	25	2.8 (M18 B5)
M18 FJS-502X	M18 FUEL™	-	0 - 3500	25	2.9 (M18 B5)
M18 BJS-402C	M18™	-	0 - 2800	25	2.5 (M18 B4)
M12 CHZ-602X	M12 FUEL™	-	0 - 3000	15.9	1.6 (M12 B6)
C12 HZ-202C	M12™	-	0 - 3000	13	1.2 (M12 B2)
M12 FJS-422X	M12 FUEL™	-	800 - 3000	22	1.7 (M12 B2)

3 MULTI-TOOLS

	Platform	Oscillation angle left/ right (°)	No load speed (rpm)	Weight with battery pack (EPTA) (kg)
M18 FMT-502X	M18 FUEL™	2.1	10,000 - 20,000	1.9 (M18 B5)
M18 BMT-421C	M18™	1.7	12,000 - 18,000	1.7 (M18 B2)
M12 FMT-422X	M12 FUEL™	1.8	10,000 - 20,000	1.6 (M12 B2)
C12 MT-402B	M12™	1.5	5000 - 20,000	1.2 (M18 B4)



SCAN HERE TO VIEW OUR PPE RANGE



SCAN HERE TO VIEW OUR SAWING AND CUTTING BLADES



M18 FCS66GR3 **M18 FUEL™ GUIDE RAIL COMPATIBLE CIRCULAR SAW**



- The M18 FUEL™ circular saw delivers the power to rip cut and maintain the 6,000 RPM's throughout the cut for a faster cutting experience due to the FORGE™ technology built into this saw - with the ability to cut up to 700 pieces of 90 mm x 45 mm pine stud on one 12.0 Ah battery charge or 64 linear metres in 42 mm thick pine panel

	M18 FCS66GR3-0	M18 FCS66GR3-121C
Kit included	No batteries supplied, No charger supplied, Gift box/No kitbox or bag supplied	1 x M18 HB12 Battery pack, M12-18 FC Charger, Kitbox
Article Number	4933493491	4933493492
EAN Code	4058546483623	4058546483630

M18 BLCS66 **M18™ BRUSHLESS 66 MM CIRCULAR SAW FOR WOOD AND PLASTICS**



BRUSHLESS

- M18™ brushless circular saw with a 190 mm blade giving a 66 mm depth of cut which enables the saw to cut three stacked 19 mm OSB boards
- REDLINK™ overload protection electronics in tool and battery pack deliver best in class system durability

	M18 BLCS66-0X	M18 BLCS66-502X
Kit included	No batteries supplied, No charger supplied, HD Box	2 x M18 B5 Battery packs, M12-18 FC Charger, HD Box
Article Number	4933464589	4933464590
EAN Code	4058546225346	4058546225353

M18 ONEFSZ **M18 FUEL™ ONE-KEY™ SAWZALL™**



- M18 FSZ but with ONE-KEY™ technology
- Connect via Bluetooth® with the ONE-KEY™ app
- ONE-KEY™ tool customisation allows the user to optimise their tool for specific applications
- ONE-KEY™ tool tracking & security offers a free of charge cloud-based tracking network and inventory management platform for your tools. ONE-KEY™ also features a remote locking functionality

	M18 ONEFSZ-0X	M18 ONEFSZ-502X
Kit included	No batteries supplied, No charger supplied, HD Box	2 x M18 B5 Battery packs, M12-18 FC Charger, HD Box
Article Number	4933478296	4933478294
EAN Code	4058546344733	4058546344719

M18 FSZ **M18 FUEL™ SAWZALL™**



- Brushless POWERSTATE™ motor for up to 5x longer motor life and up to 30% faster cutting
- Patented gear protecting clutch - extends gear and motor life by absorbing high impact forces caused by sudden blade lock-ups
- Wear resistant lever actuated FIXTEC™ blade clamp provides fast and easy blade changes
- Metal reinforced battery connection provides improved durability and battery retention over life

	M18 FSZ-0X	M18 FSZ-502X
Kit included	No batteries supplied, No charger supplied, HD Box	2 x M18 B5 Battery packs, M12-18 FC Charger, HD Box
Article Number	4933478293	4933478291
EAN Code	4058546344702	4058546344689

M18 FSX **M18 FUEL™ SUPER SAWZALL™**



- The M18 FUEL™ Super SAWZALL™ delivers the power to cut at the same speed as an equivalent AC reciprocating saw - with the ability to cut 150 pieces of 290 mm x 45 mm pine on one 12.0 Ah battery charge

	M18 FSX-0C	M18 FSX-801C
Kit included	No batteries supplied, No charger supplied, Kitbox	1 x M18 FB8 Battery pack, M12-18 FC Charger, Kitbox
Article Number	4933464724	4933499177
EAN Code	4058546226695	4058546563417

M18 BSX **M18™ SAWZALL™**



- High performance 4-pole motor delivers maximum power whilst maximising the power to weight ratio
- REDLINK™ overload protection electronics in tool and battery pack deliver best in class system durability
- Patented FIXTEC™ clamp for fast and easy keyless blade change
- Counter balance mechanism to reduce vibrations 15.2 m/s² in wooden beams

	M18 BSX-0	M18 BSX-402C
Kit included	No batteries supplied, No charger supplied, No kitbox or bag supplied	2 x M18 B4 Battery packs, M12-18 C Charger, Kitbox
Article Number	4933447275	4933447285
EAN Code	4002395006113	4002395006120

M18 FHZ **M18 FUEL™ HACKZALL™**



- With a 22 mm stroke length for controlled cutting wand a no load stroke rate of 3000 spm
- Patented FIXTEC™ clamp for quick and efficient blade change
- Pivoting shoe allows the user to optimise his cutting position
- Built in LED light improves visibility in low light cutting applications

	M18 FHZ-0X	M18 FHZ-502X
Kit included	No batteries supplied, No charger supplied, HD Box	2 x M18 B5 Battery packs, M12-18 FC Charger, HD Box
Article Number	4933459887	4933459885
EAN Code	-MISSING-	4058546030575

C18 HZ **M18™ HACKZALL™**



- High performance compact one handed use HACKZALL™, measuring only 375mm in length, makes it ideal for working within confined spaces
- REDLINK™ overload protection electronics in tool and battery pack deliver best in class system durability
- Dual gear counter balance reduces vibration and increases tool life

	C18 HZ-0	C18 HZ-402B
Kit included	No batteries supplied, No charger supplied, No kitbox or bag supplied	2 x M18 B4 Battery packs, M12-18 C Charger, Tool bag
Article Number	4933416785	4933441340
EAN Code	4002395237982	4002395001491

M18 FBJS

M18 FUEL™ BODY GRIP JIGSAW

M18 FUEL



- Patented FIXTEC™ blade clamp for fast and easy blade change
- 3500 SPM delivers smooth cuts, minimised chipping and vibration
- 5 stage pendulum action for increased cutting performance
- Brushless POWERSTATE™ motor for fast cutting, long tool life and up to 32 m in 19 mm OSB (on a 5.0 Ah pack)

	M18 FBJS-0X	M18 FBJS-502X
Kit included	No batteries supplied, No charger supplied, HD Box	2 x M18 B5 Battery packs, M12-18 FC Charger, HD Box
Article Number	4933464799	4933464800
EAN Code	4058546227449	4058546227456

M18 FJS

M18 FUEL™ TOP HANDLE JIGSAW

M18 FUEL



- Dust blower keeps the cut line free of wood dust
- Keyless bevel facility on the base plate allows for adjustment between 0 - 45°
- Patented FIXTEC™ blade clamp for fast and easy blade change
- 5 stage pendulum action for increased cutting performance

	M18 FJS-0X	M18 FJS-502X
Kit included	No batteries supplied, No charger supplied, HD Box	2 x M18 B5 Battery packs, M12-18 FC Charger, HD Box
Article Number	4933464726	4933464727
EAN Code	4058546226718	4058546226725

M18 BJS

M18™ TOP HANDLE JIGSAW

M18



- High performance motor delivers 2800 spm for fast cutting
- REDLINK™ overload protection electronics in tool and battery pack deliver best in class system durability
- Patented FIXTEC™ blade clamp for fast and easy blade change
- Keyless bevel facility on the base plate allows for adjustment between 0 - 45°

	M18 BJS-0	M18 BJS-402C
Kit included	No batteries supplied, No charger supplied, No kitbox or bag supplied	2 x M18 B4 Battery packs, M12-18 C Charger, Kitbox
Article Number	4933451391	4933451389
EAN Code	-MISSING-	4002395157976

M18 FMT

M18 FUEL™ MULTI-TOOL

M18 FUEL



- POWERSTATE™ brushless motor pairs with an aggressive oscillation angle of 2.1° (left/ right) and 10,000 - 20,000 OPM to deliver one of the fastest cut speeds in the industry
- Suitable for many demanding applications with ease, such as rip cuts through hardwoods and nail embedded wood
- 10-setting dial with an auto-load feature allows users to adjust the speed to the application

	M18 FMT-0X	M18 FMT-502X
Kit included	No batteries supplied, No charger supplied, HD Box	2 x M18 B5 Battery packs, M12-18 FC Charger, HD Box
Article Number	4933478491	4933478492
EAN Code	4058546346843	4058546346850

M18 BMT

M18™ MULTI-TOOL

M18



- Unique cutting depth stop adaptor to prevent over-cutting in material
- Productivity enhancing FIXTEC™ tool free blade change with universal blade change adaptor included to accept all competitor blades
- 12 variable speed settings from 12,000 - 18,000 orbits per minute and 3.4° oscillation movement allows quick completion of professional applications into materials such as metal, wood and plastic

	M18 BMT-0	M18 BMT-421C
Kit included	No batteries supplied, No charger supplied, No kitbox or bag supplied	1 x M18 B4, 1 x M18 B2 Battery packs, M12-18 C Charger, Kitbox
Article Number	4933446203	4933446210
EAN Code	-MISSING-	4002395004911

M18 BP

M18™ PLANER

M18



- Adjustable depth of cut from 0 to 2 mm with twenty locking positions allows the user to accurately set the amount of material to be removed in one pass
- Up to 10.7 mm of rebate depth
- High performance 4-pole motor delivers 14,000 rpm to achieve optimum surface finish
- Faster material removal with two double edged carbide blades over a planing width of 82 mm

	M18 BP-0	M18 BP-402C
Kit included	No batteries supplied, No charger supplied, No kitbox or bag supplied	2 x M18 B4 Battery packs, M12-18 C Charger, Kitbox
Article Number	4933451113	4933451114
EAN Code	4002395137374	4002395137381

M18 FR12

M18 FUEL™ 12 MM ROUTER

M18 FUEL



- POWERSTATE™ brushless motor in combination with the HIGH OUTPUT™ 5.5 Ah battery pack supplies constant power for faster cuts and reduced heat in high demand applications with the equivalent amount of power as a corded unit
- Variable speed from 12,000 RPM to 25,000 RPM for clean and accurate cutting in a wide range of material

	M18 FR12-0X	M18 FR12KIT-0P
Standard equipment	1/4", 8 mm, 12 mm, 1/2" collets, side fence, sub base, wrench, dust extraction pipe	1/4", 8 mm, 12 mm, 1/2" collets, side fence, sub base, wrench, dust extraction pipe and plunge base
Kit included	No batteries supplied, No charger supplied, HD Box	No batteries supplied, No charger supplied, PACKOUT™ box
Article Number	4933493304	4933493305
EAN Code	4058546481759	4058546481766

M18 FTR8

M18 FUEL™ TRIM ROUTER WITH 8 MM/ 6 MM COLLETS AND BASES

M18 FUEL



- POWERSTATE™ brushless motor delivers the power of AC trim routers, max. 31,000 rpm for powerful, smooth cutting
- Variable speed dial allows users to adjust the speed between 10,000 and 31,000 rpm to choose the best control for the application at hand
- All day run time on a single charge of an M18™ 5.0 Ah battery (up to 115 m)

	M18 FTR8-0X
Kit included	No batteries supplied, No charger supplied, HD Box
Article Number	4933479073
EAN Code	4058546368678

M18 BQSS
M18™ QUARTER SHEET SANDER

M18



- High performance motor delivers 11,000 to 13,000 sanding strokes per minute for faster material removal
- Variable speed wheel with 6 speed settings allows the correct speed to be set for different types of material
- Universal hook and loop sanding pad allows easy changing of sanding sheets
- Paper retention clips for use with standard sheet sand paper

	M18 BQSS-0	M18 BQSS-502B
Kit included	No batteries supplied, No charger supplied, No kitbox or bag supplied	2 x M18 B5 Battery packs, M12-18 C Charger, Tool bag
Article Number	4933479966	4933479967
EAN Code	4058546377601	4058546377618

M18 FBTS75
M18 FUEL™ 75 MM BELT SANDER

M18 FUEL



- Compact design, with a flat front and side edge allows flush sanding capability
- Captures 90% of dust either through the universal dust port or with the multi layered dust bag
- Variable speed adjustable with a belt speed range from 230 to 410 m/s
- Tool-free adjustable pommel allows for adjustment of the front handle letting the user find the optimum sanding position

	M18 FBTS75-0	M18 FBTS75-552X
Kit included	No batteries supplied, No charger supplied, No kitbox or bag supplied	2 x M18 HB5.5 Battery packs, M12-18 FC Charger, HD Box
Article Number	4933479614	4933479615
EAN Code	4058546374082	4058546374099

M18 FROS125
M18 FUEL™ 125 MM RANDOM ORBIT SANDER

M18 FUEL



- The M18 FUEL™ sander has a 2.5 mm orbit with 12,000 RPM's which allows a fast and efficient stock removal rate of 220 g of material per charge of one M18™ 5.0 Ah battery
- Fitted with VacLink technology which allows the tool to turn compatible MILWAUKEE® dust extractors on and off via Bluetooth®

	M18 FROS125-0B	M18 FROS125-502X
Kit included	No batteries supplied, No charger supplied, Tool bag	2 x M18 B5 Battery packs, M12-18 FC Charger, HD Box
Article Number	4933498253	4933498254
EAN Code	4058546521226	4058546521233

M18 BOS125
M18™ 125 MM RANDOM ORBITAL SANDER

M18



- High performance motor delivers 14,000 to 24,000 sanding strokes per minute for faster material removal
- REDLINK™ overload protection electronics in tool and battery pack deliver best in class system durability
- Variable speed wheel with 6 speed settings allows the correct speed to be set for different types of material

	M18 BOS125-0	M18 BOS125-502B
Kit included	No batteries supplied, No charger supplied, No kitbox or bag supplied	2 x M18 B5 Battery packs, M12-18 C Charger, Tool bag
Article Number	4933464228	4933464229
EAN Code	-MISSING-	4058546221744

M18 FAC
M18 FUEL™ AIR COMPRESSOR

M18 FUEL



- POWERSTATE™ brushless motor delivers a maximum air pressure of 9.31 bar and 48 l/m at 2.8 bar which delivers enough performance to run common finish nailers and staplers
- At only 68 dB(A) this is one of the quietest cordless compressors on the market allowing for a more comfortable working environment on the jobsite

	M18 FAC-0
Kit included	No batteries supplied, No charger supplied, No kitbox or bag supplied
Article Number	4933472166
EAN Code	4058546325626

M18 FFN21
M18 FUEL™ 21° FRAMING NAILER 2-MODE

M18 FUEL



- Fires standard framing nails which fits an angled magazine at 20° to 22°
- Ready to Fire Nail Technology eliminates ramp-up time between each nail discharge
- No gas cartridges and no cleaning required, designed to deliver durability and reliability to the most demanding users with very little maintenance
- Two mode selection allows for sequential fire for precision or bump fire for speed

	M18 FFN21-0C
Kit included	No batteries supplied, No charger supplied, Kitbox
Article Number	4933478993
EAN Code	4058546362751

M18 FFN
M18 FUEL™ 34° FRAMING NAILER 2-MODE

M18 FUEL



- Excellent power to consistently seat nails sub-flush to the surface in hardwoods
- Ready to Fire Nail Technology eliminates ramp-up time between each nail discharge
- No gas cartridges and no cleaning required, designed to deliver durability and reliability to the most demanding users with very little maintenance
- Two mode selection allows for sequential fire for precision or bump fire for speed

	M18 FFN-0C	M18 FFN-502C
Kit included	No batteries supplied, No charger supplied, Kitbox	2 x M18 B5 Battery packs, M12-18 FC Charger, Kitbox
Article Number	4933471406	4933471404
EAN Code	4058546290344	4058546290320

M18 FFNS
M18 FUEL™ 34° FRAMING NAILER WITH SINGLE SHOT ONLY

M18 FUEL



- Single shot mode only allows for precision placement of each nail fired
- Fires standard framing nails which fits an angled magazine at 30° or 34°
- No gas cartridges and no cleaning required, designed to deliver durability and reliability to the most demanding users with very little maintenance
- Excellent power to consistently seat nails sub-flush to the surface in hardwoods

	M18 FFNS-502C
Kit included	2 x M18 B5 Battery packs, M12-18 FC Charger, Kitbox
Article Number	4933478302
EAN Code	4058546344795

M18 FDN M18 FUEL™ DUPLEX NAILER

M18 FUEL



- Fires MILWAUKEE® 21° collated duplex nails 3.3 mm x 73 mm and 3.3 mm x 92 mm
- Ready to Fire Nail Technology eliminates ramp-up time between each nail discharge
- No gas cartridges and no cleaning required, designed to deliver durability and reliability to the most demanding users with very little maintenance
- Two mode selection allows for sequential fire for precision or bump fire for speed

M18 FDN-0C

Kit included	No batteries supplied, No charger supplied, Kitbox
Article Number	4933493600
EAN Code	4058546484712



M18 FRCN45 M18 FUEL™ ROOFING COIL NAILER

M18 FUEL



- No gas cartridges and no cleaning required, designed to deliver durability and reliability to the most demanding users with very little maintenance
- Dry-Fire lockout stops the tool being fired when there are no nails left in the coil cage
- Ready to Fire Nail Technology eliminates ramp-up time between each nail discharge

M18 FRCN45-0X

M18 FRCN45-302X

Kit included	No batteries supplied, No charger supplied, HD Box	2 x M18 HB3 Battery packs, M12-18 FC Charger, HD Box
Article Number	4933498168	4933498169
EAN Code	4058546520373	4058546520380

M18 FN16GA M18 FUEL™ 16 GA ANGLED NAIL FINISH NAILER 2-MODE

M18 FUEL



- Fire 16 Gauge nails with a 20° pitch
- Tool-free, quick and easy depth adjustment to assure nails are driven sub-flush
- No gas cartridges and no cleaning required, designed to deliver durability and reliability to the most demanding users with very little maintenance
- Excellent power to consistently seat nails sub-flush to the surface in hardwoods

M18 FN16GA-0X

M18 FN16GA-202X

Kit included	No batteries supplied, No charger supplied, HD Box	2 x M18 B2 Battery packs, M12-18 FC Charger, HD Box
Article Number	4933478094	4933478092
EAN Code	4058546340278	4058546340254

M18 FN15GA M18 FUEL™ 15 GA ANGLED NAIL FINISH NAILER 2-MODE

M18 FUEL



- Fires 15 gauge nails with a 34° pitch
- Fires up to 1200 nails per charge on a REDLITHIUM™ 2.0 Ah battery pack for maximum productivity
- No gas cartridges and no cleaning required, designed to deliver durability and reliability to the most demanding users with very little maintenance
- Ready to Fire Nail Technology eliminates ramp-up time between each nail discharge

M18 FN15GA-0X

Kit included	No batteries supplied, No charger supplied, HD Box
Article Number	4933478091
EAN Code	4058546340247

M18 FN18GS M18 FUEL™ 18 GS FINISH NAILER

M18 FUEL



- Fires 18 gauge straight nails with a 0° pitch
- Different shaped noses stored on board allows the user to get the best finish no matter what the application
- No gas cartridges and no cleaning required, designed to deliver durability and reliability to the most demanding users with very little maintenance
- Smaller nail hole, the exact size of the nail head leaving a neater finish

M18 FN18GS-0X

M18 FN18GS-202X

Kit included	No batteries supplied, No charger supplied, HD Box	2 x M18 B2 Battery packs, M12-18 FC Charger, HD Box
Article Number	4933471409	4933471407
EAN Code	4058546290375	4058546290351

M18 FN16GS M18™ FUEL™ 16 GA STRAIGHT FINISH NAILER

M18 FUEL



- Fire 16 gauge straight nails with a 0° pitch from 25 mm - 64 mm long
- Quick and easy tool free adjustable nail driving depth
- Smaller nail hole, the exact size of the nail head leaving a neater finish
- Small work contact bracket allows the user to fire and sink nails at a more acute angle
- Dry-Fire lockout stops the tool being fired when there are no nails left in the magazine

M18 FN16GS-0X

Kit included	No batteries supplied, No charger supplied, HD Box
Article Number	4933493353
EAN Code	4058546482244

M18 FFUS M18 FUEL™ FENCING UTILITY STAPLER

M18 FUEL



- Power to fire MILWAUKEE® 9 gauge barbed collated staples from 40 mm to 50 mm
- Fires up to 600 staples per charge on a REDLITHIUM™ 3.0 Ah battery pack for maximum productivity
- No gas cartridges and no cleaning required, designed to deliver durability and reliability to the most demanding users with very little maintenance

M18 FFUS-0C

M18 FFUS-302C

Kit included	No batteries supplied, No charger supplied, Kitbox	2 x M18 HB3 Battery packs, M12-18 FC Charger, Kitbox
Article Number	4933479834	4933479832
EAN Code	4058546376284	4058546376260

GET THE RIGHT NAILER/ STAPLER FOR THE JOB

1 FRAMING NAILERS



2 FINISHING NAILERS



3 FENCING UTILITY STAPLER



4 STAPLERS



5 CONCRETE FORMWORK



6 ROOFING COIL NAILER



	Platform	Collation angle (°)	Nail diameter (mm)	Nail type (mm)	Staple strip length (mm)	Staple strip width (mm)	Magazine capacity	Weight with battery pack (EPTA) (kg)
1.	M18 FFN21-0C	M18 FUEL™	20 - 22	2.9 - 3.8	50 - 90	-	51	5.0 (M18 B5)
1.	M18 FFN-502C	M18 FUEL™	30 - 34	2.9 - 3.3	50 - 90	-	51	5.1 (M18 B5)
1.	M18 FFNS-502C	M18 FUEL™	30 - 34	2.9 - 3.3	50 - 90	-	51	5.1 (M18 B5)
2.	M18 FN18GS-202X	M18 FUEL™	0	1.2	16 / 54	-	110	3.1 (M18 B2)
2.	M18 FN16GA-202X	M18 FUEL™	20	1.6	32 - 64	-	110	3.3 (M18 B2)
2.	M18 FN16GS-0X	M18 FUEL™	0	1.6	25 - 64	-	110	3.2 (M18 B2)
2.	M18 FN15GA-0X	M18 FUEL™	34	1.8	32 - 64	-	110	3.3 (M18 B2)
2.	M12 FCN18GS-202X	M12 FUEL™	0	1.2	16 - 38	-	110	2.1 (M12 B2)
3.	M18 FFUS-302C	M18 FUEL™	0	4	-	38 - 51	10.3	45
4.	M18 FNCS18GS-202X	M18 FUEL™	0	-	-	9.5 - 38	5.7 - 6.35	108
4.	M12 BCST-0	M12™	0	-	-	25.4	19	45
4.	M12 BST-202X	M12™	0	-	-	6 - 14	10.6	89
5.	M18 FDN-0C	M18 FUEL™	21°	3.3	73 - 92	-	44	5.1 (M18 B5)
6.	M18 FRCN45-302X	M18 FUEL™	15°	3	19 - 45	-	120	3.8 (M18 HB3)



SCAN HERE TO VIEW
OUR PPE RANGE



SCAN HERE TO VIEW
AVAILABLE NAILS
AND STAPLES



M18 FNCS18GS M18 FUEL

M18 FUEL™ NARROW CROWN STAPLER 2-MODE



- Accepts narrow crown staplers from 9.5 mm to 38 mm
- Ready to fire nail technology eliminates ramp-up time between each staple discharge
- No gas cartridges and no cleaning required, designed to deliver durability and reliability to the most demanding users with very little maintenance

	M18 FNCS18GS-0X	M18 FNCS18GS-202X
Kit included	No batteries supplied, No charger supplied, HD Box	2 x M18 B2 Battery packs, M12-18 FC Charger, HD Box
Article Number	4933471942	4933471940
EAN Code	4058546298418	4058546298395



M18 F2VC23L M18 FUEL

M18 FUEL™ 23L L-CLASS VACUUM



- The M18 FUEL™ 23 litre L class Wet/Dry Vacuum brings outstanding performance, durability, and versatility to jobsite cleanup
- With a maximum air flow of 3086 l/min and 192 mbar this provides excellent performance for both wet and dry clean up applications

	M18 F2VC23L-0
Kit included	No batteries supplied, No charger supplied, No kitbox or bag supplied
Article Number	4933478964
EAN Code	4058546362461

M18 FBPV M18 FUEL

M18 FUEL™ BACKPACK VACUUM



- HEPA filter will collect 99.97% of airborne particles down to 0.3 microns
- Dust class L. Standard MAK-factor > 1 mg/m³
- Low noise of only 76 db (operating sound level)
- DEK 26 compatible allows the vacuum to be easily connected to a power tool
- Cyclonic technology for longer filter life, extended peak performance and bag-less debris collection

	M18 FBPV-0
Kit included	No batteries supplied, No charger supplied, No kitbox or bag supplied
Article Number	4933464483
EAN Code	4058546224288

M18 FPOVCL M18 FUEL

M18 FUEL™ PACKOUT™ WET/ DRY VACUUM

PACKOUT™



- The M18 FUEL™ PACKOUT™ wet/ dry vacuum is fully compatible with the MILWAUKEE® PACKOUT™ Modular Storage System
- Delivers up to 30 minutes of run time on a HIGH OUTPUT™ 8.0 Ah battery pack in high mode and over 50 minutes in low mode
- Extendable hose up to 1.6 m for extended reach and versatility

	M18 FPOVCL-0
Kit included	No batteries supplied, No charger supplied, No kitbox or bag supplied
Article Number	4933478187
EAN Code	4058546341206

PODS-1 M18 FUEL

PACKOUT™ COMPATIBLE DUST SEPERATOR

PACKOUT™



- Separates up to 99.9% of common jobsite debris
- Captures debris before reaching vacuum, resulting in less filter clogs and longer sustained suction
- Keeps debris in cyclone, eliminating user frustration of vacuum maintenance
- Fully compatible with PACKOUT™ Modular Storage System for easy transportation on, off, and around the job site

	PODS-1
Article Number	4932498256
EAN Code	4058546521257

M18 VC2 M18

M18™ WET/ DRY VACUUM



- Powerful 18 V motor with a maximum air flow of 1300 l/min/ 80 bar provides excellent suction power for both wet and dry clean up applications
- HEPA filter will collect 99.97% of airborne particles down to 0.03 microns for fine dust collection
- Up to 30 minutes run time with M18™ HIGH OUTPUT™ 5.5 Ah battery pack

	M18 VC2-0
Kit included	No batteries supplied, No charger supplied, No kitbox or bag supplied
Article Number	4933464029
EAN Code	4058546219741

M18 CV M18

M18™ HAND VAC



- Excellent suction power for wood, metal and common debris
- HEPA filter will collect 99.97% of airborne particles down to 0.3 microns
- Lock on switch reduces fatigue during sustained use
- Versatile accessories for small or large clean up areas
- Secure canister lock guards against unwanted spillage

	M18 CV-0
Kit included	No batteries supplied, No charger supplied, No kitbox or bag supplied
Article Number	4933459204
EAN Code	4002395289988

M18 BBL
M18™ BATTERY BLOWER

M18



- Compact body - clears dirt and debris in tight spaces
- Power control - 3 speed settings with variable speed trigger
- Versatile attachments - nozzle extension (228.6 mm), universal inflator/ deflator attachment
- Removable nozzle for easy, convenient storage
- Lock-on switch

M18 BBL-0

Kit included	No batteries supplied, No charger supplied, No kitbox or bag supplied
Article Number	4933446216
EAN Code	4002395004942

M18 ARFHP
M18™ HIGH PERFORMANCE AIR FAN

M18



- Three speed settings for optimised air flow up to 6 metres per second
- Adjustable head allows the user to utilise the fan in various heights and positions over a range of 360°
- Efficient air circulation circulates the air up to 5.775 m³/h
- Compact design with integrated carry handle to maximise portability

M18 ARFHP-0

Kit included	No batteries supplied, No charger supplied, No kitbox or bag supplied
Article Number	4933492110
EAN Code	4058546414771

M18 AFG2
M18™ AIR FAN

M18



- Variable speed dial and a 180 mm blade diameter for optimised air flow up to 1.444 m³/h
- Adjustable head allows the user to utilise the fan in various heights and positions over a range of 300°
- Compact design with integrated carry handle to maximise portability
- Compatible with the MILWAUKEE® PACKOUT™ system

M18 AFG2-0

Kit included	No batteries supplied, No charger supplied, No kitbox or bag supplied
Article Number	4933493443
EAN Code	4058546483142

M18 BI
M18™ INFLATOR

M18



- Compact lightweight design for fast inflation of car, light truck and compact equipment tyres. Top off 235/65R16 sprinter tyres in under 1 minute
- Anti-vibration stand with all rubber feet for no movement while inflating
- Top off up to 30 tyres on an M18™ 5.0 battery pack
- 10.3 max bar capacity

M18 BI-0

Kit included	No batteries supplied, No charger supplied, No kitbox or bag supplied
Article Number	4933478706
EAN Code	4058546348991

M18 PRCDAB+
M18™ PACKOUT™ RADIO CHARGER

M18



PACKOUT™



- Premium 360° surround sound speakers with a 40 W amplifier producing rich and full sound for large and outdoor spaces
- DAB+ and AM/FM tuner with the digital processor delivers highest reception accuracy, signal clarity and additional information like: song, artist and accurate time
- Digital Bluetooth® receiver: Plays music up to 30 m away from your smartphone, computer or tablet

M18 PRCDAB+-0

Kit included	No batteries supplied, No charger supplied, No kitbox or bag supplied
Article Number	4933472112
EAN Code	4058546325084

M18 RADDAB+G2
M18™ JOBSITE RADIO DAB+

M18



- High performance audio system - DAB+/FM tuner with digital processor delivers high reception accuracy and signal clarity
- Digital Bluetooth® receiver, plays music up to 36 m away from your smartphone, computer or tablet
- Integrated handles and on board storage allow for easy transport and storage for phones
- Dual 8.89 cm woofers provide balanced & clear sound

M18 RADDAB+G2-0

Kit included	No batteries supplied, No charger supplied, No kitbox or bag supplied
Article Number	4933492344
EAN Code	4058546417116

M18 RC
M18™ JOBSITE RADIO CHARGER WITH BLUETOOTH®

M18



- Built in charger function allows for quick, convenient charging of any M18™ battery or electronic devices via USB port
- Digital Bluetooth® receiver: play music up to 30 m away from your smartphone, computer, or tablet
- AC/DC versatility: powered by MILWAUKEE® M18™ batteries, or 230 V mains supply

M18 RC-0

Kit included	No batteries supplied, No charger supplied, No kitbox or bag supplied
Article Number	4933446639
EAN Code	4002395005420

M18 SPEJSG2
M18™ JOBSITE SPEAKER

M18



- Advanced technology Bluetooth® job site speaker
- Bluetooth® 5.3 plays music up to 60 m away from your smartphone, computer or tablet
- Balanced & clear sound at all volumes
- Premium speaker with bass port
- Provides audio for small to medium sized areas
- Audio link connects over 200 MILWAUKEE® speakers

M18 SPEJSG2-0

Kit included	No batteries supplied, No charger supplied, No kitbox or bag supplied
Article Number	4933492330
EAN Code	4058546484019

M12 FUEL™

DRIVEN TO OUTPERFORM.™

M12 PORTABLE PRODUCTIVITY.
TRADE FOCUSED.
SYSTEM WIDE.



M12 FUEL™ is engineered for the most demanding tradesmen in the world. M12 FUEL™ delivers extreme performance in a compact structure and features three MILWAUKEE® exclusive innovations - the POWERSTATE™ brushless motor, REDLITHIUM™ battery pack and REDLINK PLUS™ intelligence hardware and software - that deliver incredible power, run time and durability.

Simply put, M12 FUEL™ offers the best, full circle technology that drives, protects and powers your cordless tools.

1



POWERSTATE™ BRUSHLESS MOTOR

- MILWAUKEE® designed and built brushless motor
- Provides increased efficiency
- Lasts longer and delivers maximum power*

2



REDLINK PLUS™ INTELLIGENCE

- Individual cell monitoring to optimise tool run time and ensure long term pack durability
- Advanced system electronics with unique digital performance enhancement
- Total system communication with overload protection increases tool life

3



REDLITHIUM™ BATTERY PACKS

- Total system communication with overload protection increases tool life
- Fade-free performance to deliver more run time and more work over pack life
- Fuel gauge displays remaining charge
- Operates down to -20°C



MORE CAPABLE.

LIGHTWEIGHT.

MORE COMPACT.

M12 FHAC16 
M12 FUEL™ COMPACT 16 MM SDS-PLUS HAMMER



- Compact and balanced 12 V rotary hammer with 1.15 J of impact energy
- 4-mode operation: rotary hammer, hammer only, rotation only and selectable work position of the chisel (variolock) for maximum versatility
- Anti-vibration system (AVS) for decreased user fatigue and lower vibration exposure. Also, an added anti-vibration side handle for lowering the vibration exposure even further
- Optimised hammer drilling up to 10 mm

	M12 FHAC16-0	M12 FHAC16-0X	M12 FHAC16-502X
Kit included	No batteries supplied, No charger supplied, No kitbox or bag supplied	No batteries supplied, No charger supplied, HD Box	2 x M12 HB5 Battery packs, C12 C Charger, HD Box
Article Number	4933499183	4933499184	4933499185
EAN Code	4058546563479	4058546563486	4058546563493

M12 UDEL 
M12™ UNIVERSAL DUST EXTRACTOR



- Fits all MILWAUKEE® SDS-plus and the majority of competitor's hammers between 41-61 mm neck size with just one adjustable side handle which can be mounted right or left of the hammer
- Delivering more than 40 min run time on a single M12 B2 2.0 Ah battery
- Due to telescopic nozzle capable of operating with up to 210 mm long SDS-plus drill bits

	M12 UDEL-0B	M12 UDEL-201B
Kit included	No batteries supplied, No charger supplied, Tool bag	1 x M12 B2 Battery pack, C12 C Charger, Tool bag
Article Number	4933471460	4933471461
EAN Code	4058546290887	4058546290894

M12 FPD2 
M12 FUEL™ SUB COMPACT PERCUSSION DRILL



- Extremely compact design of 152 mm length for access into tight spaces
- 45 Nm of torque - superior power to size ratio
- 13 mm heavy duty metal chuck for quick bit changes and bit retention
- Mechanical clutch with 13 torque settings, plus 1 for locked clutch drilling and 1 for locked clutch hammer
- On board fuel gauge, metal belt clip and LED light

	M12 FPD2-0	M12 FPD2-202X	M12 FPD2-602X
Kit included	No batteries supplied, No charger supplied, No kitbox or bag supplied	2 x M12 B2 Battery packs, C12 C Charger, HD Box	2 x M12 B6 Battery packs, C12 C Charger, HD Box
Article Number	4933479867	4933479868	4933479870
EAN Code	4058546376611	4058546376628	4058546376642

M12 FDD2 
M12 FUEL™ SUB COMPACT DRILL DRIVER



- Extremely compact design of 151 mm length for access into tight spaces
- 45 Nm of torque - superior power to size ratio
- 13 mm heavy duty metal chuck for quick bit changes and bit retention
- Mechanical clutch with 13 torque settings,
- On board fuel gauge, metal belt clip and LED light

	M12 FDD2-0	M12 FDD2-202X	M12 FDD2-602X
Kit included	No batteries supplied, No charger supplied, No kitbox or bag supplied	2 x M12 B2 Battery packs, C12 C Charger, HD Box	2 x M12 B6 Battery packs, C12 C Charger, HD Box
Article Number	4933479872	4933479873	4933479875
EAN Code	4058546376666	4058546376673	4058546376697

M12 FDDX 
M12 FUEL™ INSTALLATION DRILL/DRIVER WITH INTERCHANGEABLE HEADS



- High performance compact 4-in-1 installation drill for extreme versatility
- Removable chuck system with 4 different heads for multiples of applications
- ¼" hex drive behind chuck fitting, reduces drill length to 130 mm when required
- In-line grip for unrivaled access and control
- Brushless POWERSTATE™ motor delivers up to 34 Nm of torque
- Magnetic holder for easy bit access

	M12 FDDX-0	M12 FDDXKIT-0X	M12 FDDXKIT-202X
Standard equipment	10 mm metal chuck	10 mm metal chuck, right angle attachment, offset attachment and 6mm hex attachment	10 mm metal chuck, right angle attachment, offset attachment and 6mm hex attachment
Kit included	No batteries supplied, No charger supplied, No kitbox or bag supplied	No batteries supplied, No charger supplied, HD Box	2 x M12 B2 Battery packs, C12 C Charger, HD Box
Article Number	4933464978	4933471332	4933464979
EAN Code	4058546229238	4058546289607	4058546229245

M12 FPDX 
M12 FUEL™ SUB COMPACT PERCUSSION DRILL WITH REMOVABLE CHUCK



- High performance compact 6-in-1 percussion drill system for extreme versatility
- Removable chuck system with 3 different heads for multiples of applications
- Brushless POWERSTATE™ motor delivers up to 44 Nm of torque
- REDLINK PLUS™ intelligence system delivers an advanced digital overload protection for tool and battery and uniquely enhances the tool performance under load

	M12 FPDX-0	M12 FPDX-202X	M12 FPDXKIT-202X
Standard equipment	Removable chuck	Removable chuck	Removable chuck, offset attachment, right angle attachment
Kit included	No batteries supplied, No charger supplied, No kitbox or bag supplied	2 x M12 B2 Battery packs, C12 C Charger, HD Box	2 x M12 B2 Battery packs, C12 C Charger, HD Box
Article Number	4933464135	4933464136	4933464138
EAN Code	4058546220808	4058546220815	4058546220839

M12 BDDX 
M12™ SUB COMPACT DRILL DRIVER WITH REMOVABLE CHUCK



- High performance sub compact 5-in-1 drill driver system for extreme versatility
- Removable chuck system with 3 different heads for multiples of applications
- Standard 10 mm keyless chuck, full metal right angle ¼" hex drive head and full metal offset ¼" hex drive head
- ¼" hex drive behind chuck fitting, reduces drill length to 153 mm when required

	M12 BDDXKIT-202C
Standard equipment	Removable FIXTEC™ chuck, offset attachment, right angle drill attachment, belt clip, 25 mm P22 bit
Kit included	2 x M12 B2 Battery packs, C12 C Charger, Kitbox
Article Number	4933447836
EAN Code	4002395006601

C12 RAD 
M12™ SUB COMPACT RIGHT ANGLE DRILL



- Heavy Duty full metal gearbox and gears for superior durability and maximum torque
- REDLINK™ overload protection electronics in tool and battery pack deliver best in class system durability
- Variable speed paddle switch trigger for comfortable working in any situation
- 10 mm chuck for quick bit changes and bit retention

	C12 RAD-0	C12 RAD-202B
Kit included	No batteries supplied, No charger supplied, No kitbox or bag supplied	2 x M12 B2 Battery packs, C12 C Charger, Tool bag
Article Number	4933416900	4933441215
EAN Code	4002395237678	4002395001248

M12 CD M12 FUEL™ SUB COMPACT DRIVER

M12 FUEL



- 1/4" Hex chuck for quick easy one handed bit change
- On board fuel gauge and LED light
- Individual battery cell monitoring optimises tool run time and ensures long term pack durability

M12 CD-0

Kit included	No batteries supplied, No charger supplied, No kitbox or bag supplied
Article Number	4933440450
EAN Code	4002395000968

M12 BD M12™ SUB COMPACT DRIVER

M12



- High performance sub compact screw driver measures 175 mm in length making it ideal for working within confined spaces
- REDLINK™ overload protection electronics in tool and battery pack deliver best in class system durability
- 1/4" Hex chuck for quick easy one handed bit change
- Optimised handle for better control and improved grip

M12 BD-0

M12 BD-202C

Kit included	No batteries supplied, No charger supplied, No kitbox or bag supplied	2 x M12 B2 Battery packs, C12 C Charger, Kitbox
Article Number	4933441910	4933441900
EAN Code	4002395002566	4002395002559

M12 BSD M12™ SUB COMPACT SINGLE SPEED DRIVER

M12



- High performance compact screw driver measures 169 mm in length making it ideal for working within confined spaces
- Metal planetary gears for superior durability and maximum torque up to 20 Nm
- 1/4" Hex chuck for quick easy one handed bit change
- REDLINK™ overload protection electronics in tool and battery pack deliver best in class system durability

M12 BSD-0

Kit included	No batteries supplied, No charger supplied, No kitbox or bag supplied
Article Number	4933447135
EAN Code	4002395006021

M12 FID2 M12 FUEL™ SUB COMPACT 1/4" IMPACT DRIVER

M12 FUEL



- The compact design with a length of only 127 mm is ideal for working in confined spaces
- Outstanding power to size ratio with 170 Nm of torque
- Fast driving speed with up to 3,600 rpm and 4,000 ipm
- Tri-LEDs deliver high definition lighting to increase workspace visibility

M12 FID2-0

M12 FID2-202X

Kit included	No batteries supplied, No charger supplied, No kitbox or bag supplied	2 x M12 B2 Battery packs, C12 C Charger, HD Box
Article Number	4933479876	4933479877
EAN Code	4058546376703	4058546376710

M12 FQID M12 FUEL™ SURGE™ 1/4" HEX HYDRAULIC IMPACT DRIVER

M12 FUEL

SURGE™
HYDRAULIC DRIVER



- The M12 FUEL™ SURGE™ 1/4" Hex hydraulic impact driver is MILWAUKEE®'s quietest 12V impact driver, delivers best in class sound at only 76 dB(A) in wood fastening applications
- FLUID-DRIVE™ hydraulic powertrain reduces metal on metal contact within the tool, delivering quieter operation, smoother performance and increased durability over a standard impact

M12 FQID-0

M12 FQID-202X

Kit included	No batteries supplied, No charger supplied, No kitbox or bag supplied	2 x M12 B2 Battery packs, C12 C Charger, HD Box
Article Number	4933464972	4933464973
EAN Code	4058546229177	4058546229184

M12 BRAID M12™ SUB COMPACT RIGHT ANGLE IMPACT DRIVER

M12



- Compact right angle impact driver measures 287 mm in length making it ideal for working within confined spaces
- REDLINK™ overload protection electronics delivers best in class system durability
- Full metal gearbox and gears for superior durability and maximum torque of 68 Nm
- Compact head design with diameter of 35.6 mm

M12 BRAID-0

Kit included	No batteries supplied, No charger supplied, No kitbox or bag supplied
Article Number	4933451247
EAN Code	4002395167715

M12 FCIWF12G3 M12 FUEL™ 1/2" COMPACT IMPACT WRENCH WITH FRICTION RING

M12 FUEL



- Best in class power: 542 Nm of fastening and 746 Nm of nut-busting torque to tackle mid torque applications
- A mass of 1 kg without battery and a length of 122 mm means better access and less fatigue.
- 3,000 RPMs for exceptional application speed
- 4-Mode DRIVE CONTROL allows the user to shift into four different speed and torque settings to maximise application versatility

M12 FCIWF12G3-0

M12 FCIWF12G3-502X

Kit included	No batteries supplied, No charger supplied, No kitbox or bag supplied	2 x M12 HB5 Battery packs, C12 C Charger, HD Box
Article Number	4933493454	4933493455
EAN Code	4058546483258	4058546483265

M12 FCIWP12G3 M12 FUEL™ 1/2" COMPACT IMPACT WRENCH WITH PIN DETENT

M12 FUEL



- Best in class power: 542 Nm of fastening and 746 Nm of nut-busting torque to tackle mid torque applications
- A mass of 1 kg without battery and a length of 122 mm means better access and less fatigue
- 3,000 RPMs for exceptional application speed
- 4-Mode DRIVE CONTROL allows the user to shift into four different speed and torque settings to maximise application versatility

M12 FCIWP12G3-0

Kit included	No batteries supplied, No charger supplied, No kitbox or bag supplied
Article Number	4933493457
EAN Code	4058546483289

M12 FCIWF38G3 **M12 FUEL**
M12 FUEL™ 3/8" COMPACT IMPACT WRENCH WITH FRICTION RING



- Best in class power: 542 Nm of fastening and 746 Nm of nut-busting torque to tackle mid torque applications
- A mass of 1 kg without battery and a length of 122 mm means better access and less fatigue
- 3,000 RPMs for exceptional application speed
- 4-Mode DRIVE CONTROL allows the user to shift into four different speed and torque settings to maximise application versatility

	M12 FCIWF38G3-0	M12 FCIWF38G3-502X
Kit included	No batteries supplied, No charger supplied, No kitbox or bag supplied	2 x M12 HB5 Battery packs, C12 C Charger, HD Box
Article Number	4933493451	4933493452
EAN Code	4058546483227	4058546483234



M12 FIW14 **M12 FUEL**
M12 FUEL™ SUB COMPACT 1/4" IMPACT WRENCH



- More power, more compact, more control
- Up to 115 Nm of maximum fastening torque
- Up to 136 Nm of maximum nut busting torque
- 1/4" anvil with friction ring for quick and easy socket changes
- Brushless POWERSTATE™ motor delivers more power in a more compact size

	M12 FIW14-0
Kit included	No batteries supplied, No charger supplied, No kitbox or bag supplied
Article Number	4933464611
EAN Code	4058546225568

M12 BIW12 **M12**
M12™ SUB COMPACT 1/2" IMPACT WRENCH



- High performance sub compact impact wrench measures 171 mm in length making it ideal for working within confined spaces
- REDLINK™ overload protection electronics in tool and battery pack deliver best in class system durability
- Heavy duty full metal gearbox and gears for superior durability and maximum torque
- 1/2" square drive with pin detent for use with universal sockets

	M12 BIW12-0	M12 BIW12-202C
Kit included	No batteries supplied, No charger supplied, No kitbox or bag supplied	2 x M12 B2 Battery packs, C12 C Charger, Kitbox
Article Number	4933447134	4933447133
EAN Code	4002395006014	4002395006007

M12 BIW38 **M12**
M12™ SUB COMPACT 3/8" IMPACT WRENCH



- High performance sub compact impact wrench measures 165 mm in length making it ideal for working within confined spaces
- REDLINK™ overload protection electronics in tool and battery pack deliver best in class system durability
- Heavy duty full metal gearbox and gears for superior durability and maximum torque
- 3/8" square drive with friction ring for use with universal sockets

	M12 BIW38-0
Kit included	No batteries supplied, No charger supplied, No kitbox or bag supplied
Article Number	4933441985
EAN Code	4002395002603

M12 BPRT **M12**
M12™ SUB COMPACT RIVET TOOL



- Up to 325 x 4.8 mm stainless steel rivets on a single charge with a 2.0 Ah battery pack
- Suitable for all aluminium, steel, stainless steel and copper rivets up to 4.8 mm
- Rivets in one stroke with a 20.32 mm stroke length
- Retention nose pieces hold rivets in any orientation

	M12 BPRT-0	M12 BPRT-201X
Kit included	No batteries supplied, No charger supplied, No kitbox or bag supplied	1 x M12 B2 Battery pack, C12 C Charger, HD Box
Article Number	4933464404	4933464405
EAN Code	4058546223496	4058546223502

M12 FRAIWF12 **M12 FUEL**
M12 FUEL™ 1/2" RIGHT ANGLE IMPACT WRENCH WITH FRICTION RING



- Delivers up to 270 Nm fastening torque and 300 Nm nut-busting torque
- 4-Mode DRIVE CONTROL includes Auto Shut-Off Mode and Bolt Removal Mode which prevents over-tightening and provides more control after bolt breakaway
- The long body profile allows for more access in hard to reach spaces
- Only 71 mm head with anvil profile design allows for more access in tight spaces

	M12 FRAIWF12-0
Kit included	No batteries supplied, No charger supplied, No kitbox or bag supplied
Article Number	4933471699
EAN Code	4058546295981

M12 FRAIWF38 **M12 FUEL**
M12 FUEL™ 3/8" RIGHT ANGLE IMPACT WRENCH WITH FRICTION RING



- Delivers up to 270 Nm fastening torque and 300 Nm nut-busting torque
- 4-Mode DRIVE CONTROL includes Auto Shut-Off Mode and Bolt Removal Mode which prevents over-tightening and provides more control after bolt breakaway
- The long body profile allows for more access in hard to reach spaces
- Only 71 mm head profile design allows for more access in tight spaces

	M12 FRAIWF38-0
Kit included	No batteries supplied, No charger supplied, No kitbox or bag supplied
Article Number	4933471700
EAN Code	4058546295998

GET THE RIGHT RATCHET FOR THE JOB

1 PRECISION TOOLS

Delivering increased productivity, precise torque accuracy, and user demanded reporting functionality



2 LONG REACH

Slim head profile and an extended reach that gives you the longest reach in tight spaces



3 HIGH SPEED

Faster speed while installing and removing fasteners



4 COMPACT

Perfect mix of size and power to get into those tight areas



	Platform	ONE-KEY™	Tool reception	Max. torque (Nm)	Torque range (Nm)	Accuracy	No load speed (rpm)	Length (mm)	Weight with battery pack (EPTA) (kg)
1.	M12 ONEFTR12-201C	M12 FUEL™	ONE-KEY™	1/2" square	203.4	16.9 - 203.4	CW ±2 %, CCW ±3% 0 - 100	596,9	2.6 (M12 B2)
1.	M12 ONEFTR38-201C	M12 FUEL™	ONE-KEY™	3/8" square	135.6	13.6 - 135.6	CW ±2 %, CCW ±3% 0 - 100	591,8	2.5 (M12 B2)
2.	M12 FPTR-202X	M12 FUEL™	-	14.4 mm Hex	81	-	0 - 350	386	1.2 (M12 B2)
2.	M12 FHIR14LR-0	M12 FUEL™	-	1/4" square	47	-	0 - 450	348	1.1 (M12 B2)
2.	M12 FHIR38LR-0	M12 FUEL™	-	3/8" square	47	-	0 - 450	363	1.1 (M12 B2)
2.	M12 FIR38LR-0	M12 FUEL™	-	3/8" square	75	-	0 - 200	363	1.4 (M12 B2)
3.	M12 FHIR14-0	M12 FUEL™	-	1/4" square	47	-	0 - 450	272	1.0 (M12 B2)
3.	M12 FHIR38-0	M12 FUEL™	-	3/8" square	47	-	0 - 450	272	1.0 (M12 B2)
4.	M12 FIR12-0	M12 FUEL™	-	1/2" square	81	-	0 - 175	290	1.5 (M12 B2)
4.	M12 FIR38-0	M12 FUEL™	-	3/8" square	75	-	0 - 200	281	1.4 (M12 B2)
4.	M12 IR-201B 3/8	M12™	-	3/8" square	47	-	0 - 250	274	0.9 (M12 B2)
4.	M12 IR-201B 1/4	M12™	-	1/4" square	40	-	0 - 250	274	0.90 (M12 B2)
4.	M12 FRAWF12-0	M12 FUEL™	-	1/2" square	270	-	0-1150/ 0-2300/ 0-3000/ 0-3000	-	1.7 (M12 B4)
4.	M12 FRAWF38-0	M12 FUEL™	-	3/8" square	270	-	0-1550/ 0-2300/ 0-3000/ 0-3000	-	1.7 (M12 B4)



SCAN HERE TO VIEW OUR PPE RANGE



SCAN HERE TO VIEW COMPATIBLE IMPACT SOCKETS



M12 ONEFTR12 **M12 FUEL**
M12 FUEL™ ONE-KEY™ 1/2" DIGITAL TORQUE WRENCH



- MILWAUKEE®'s first digital torque wrench, delivers up to 50% faster installation by replacing the hand tool
- Provides 16.9 - 203.4 Nm of torque range and accuracy within ±2% for torque critical fasteners
- Faster, more productive torque reporting with ONE-KEY™ providing torque data and customisable reports for inspectors or owners

	M12 ONEFTR12-0C	M12 ONEFTR12-201C
Kit included	No batteries supplied, No charger supplied, Kitbox	1 x M12 B2 Battery pack, C12 C Charger, Kitbox
Article Number	4933464969	4933464970
EAN Code	4058546229146	4058546229153

M12 ONEFTR38 **M12 FUEL**
M12 FUEL™ ONE-KEY™ 3/8" DIGITAL TORQUE WRENCH



- MILWAUKEE®'s first digital torque wrench, delivers up to 50% faster installation by replacing the hand tool
- Provides 13.6 - 135.6 Nm of torque range and accuracy within ±2% for torque critical fasteners
- Faster, more productive torque reporting with ONE-KEY™ providing torque data and customisable reports for inspectors or owners

	M12 ONEFTR38-0C	M12 ONEFTR38-201C
Kit included	No batteries supplied, No charger supplied, Kitbox	1 x M12 B2 Battery pack, C12 C Charger, Kitbox
Article Number	4933464966	4933464967
EAN Code	4058546229115	4058546229122

M12 FPTR **M12 FUEL**
M12 FUEL™ INSIDER™ PASS-THROUGH RATCHET



- With up to 81 Nm of max torque and 350 rpm's, this tool offers the perfect combination of power and speed
- Features the lowest-profile head for best-in-class access in confined spaces
- The extended neck allows users better access in hard-to-reach places
- Pass-through sockets up to a size of 15 mm allow users to comfortably fasten and unfasten nuts on bolts of any length

	M12 FPTR-0	M12 FPTR-202X
Kit included	No batteries supplied, No charger supplied, No kitbox or bag supplied	2 x M12 B2 Battery packs, C12 C Charger, HD Box
Article Number	4933499413	4933499411
EAN Code	4058546565770	4058546565756

M12 FHIR14LR **M12 FUEL**
M12 FUEL™ 1/4" EXTENDED REACH HIGH SPEED RATCHET



- With up to 47 Nm of max torque and 450 rpm's, this tool delivers faster application speed and increased productivity for the professional user
- 19 mm low profile head design and extended neck allow users better access in tight spaces
- The industry leading FUEL™ technology combined with a reinforced mechanism and investment cast steel yoke housing provides greater durability for the professional user

	M12 FHIR14LR-0
Kit included	No batteries supplied, No charger supplied, No kitbox or bag supplied
Article Number	4933480790
EAN Code	4058546410759

M12 FHIR38LR **M12 FUEL**
M12 FUEL™ 3/8" EXTENDED REACH HIGH SPEED RATCHET



- With up to 47 Nm of max torque and 450 rpm's, this tool delivers faster application speed and increased productivity for the professional user
- 19 mm low profile head design and extended neck allow users better access in tight spaces
- The industry leading FUEL™ technology combined with a reinforced mechanism and investment cast steel yoke housing provides greater durability for the professional user

	M12 FHIR38LR-0
Kit included	No batteries supplied, No charger supplied, No kitbox or bag supplied
Article Number	4933480791
EAN Code	4058546410766

M12 FIR38LR **M12 FUEL**
M12 FUEL™ 3/8" EXTENDED REACH RATCHET



- With up to 75 Nm of max torque and 200 rpm's, this tool is the ideal fastening solution for automotive mechanics, maintenance and repair professionals
- The industry leading FUEL™ technology combined with a reinforced mechanism and investment cast steel yoke housing provides greater durability for the professional user
- Extended reach ratchet adding additional 82 mm of length for access into tight spaces

	M12 FIR38LR-0
Kit included	No batteries supplied, No charger supplied, No kitbox or bag supplied
Article Number	4933471500
EAN Code	4058546293994

M12 FHIR14 **M12 FUEL**
M12 FUEL™ 1/4" HIGH SPEED RATCHET



- With up to 47 Nm of max torque and 450 rpm's, this tool delivers faster application speed and increased productivity for the professional user
- 19 mm low profile head design allows users better access in tight spaces
- Variable speed metal trigger provides ultimate control of the tool

	M12 FHIR14-0
Kit included	No batteries supplied, No charger supplied, No kitbox or bag supplied
Article Number	4933478171
EAN Code	4058546341046

M12 FHIR38 **M12 FUEL**
M12 FUEL™ 3/8" HIGH SPEED RATCHET



- With up to 47 Nm of max torque and 450 rpm's, this tool delivers faster application speed and increased productivity for the professional user
- 19 mm low profile head design allows users better access in tight spaces
- Variable speed metal trigger provides ultimate control of the tool

	M12 FHIR38-0
Kit included	No batteries supplied, No charger supplied, No kitbox or bag supplied
Article Number	4933478172
EAN Code	4058546341053

M12 FIR12

M12 FUEL™ SUB COMPACT 1/2" RATCHET

M12 FUEL



- With up to 81 Nm of max torque and 175 rpm's, this tool is the ideal fastening solution for automotive mechanics, maintenance and repair professionals
- Low profile head design allows users better access in tight spaces
- The industry leading FUEL™ technology combined with a reinforced mechanism and investment cast steel yoke housing provides greater durability for the professional user

M12 FIR12-0

Kit included	No batteries supplied, No charger supplied, No kitbox or bag supplied
Article Number	4933459800
EAN Code	4058546029722

M12 FIR38

M12 FUEL™ SUB COMPACT 3/8" RATCHET

M12 FUEL



- With up to 75 Nm of max torque and 200 rpm's, this tool is the ideal fastening solution for automotive mechanics, maintenance and repair professionals
- Low profile head design allows users better access in tight spaces
- The industry leading FUEL™ technology combined with a reinforced mechanism and investment cast steel yoke housing provides greater durability for the professional user

M12 FIR38-0

M12 FIR38-201B

Kit included	No batteries supplied, No charger supplied, No kitbox or bag supplied	1 x M12 B2 Battery pack, C12 C Charger, Tool bag
Article Number	4933459797	4933459798
EAN Code	4058546029692	4058546029708

M12 IR

M12™ SUB COMPACT RATCHET

M12



- Pneumatic performance with cordless convenience, 47 Nm of torque and no load speed of 250 rpm
- REDLINK™ overload protection electronics in tool and battery pack deliver best in class system durability
- Reinforced housing - provides high durability similar to steel ratchets
- Compact design - ideal for tight spaces and small engine bays

M12 IR-201B 1/4

M12 IR-201B 3/8

Kit included	1 x M12 B2 Battery pack, C12 C Charger, Tool bag	1 x M12 B2 Battery pack, C12 C Charger, Tool bag
Article Number	4933441725	4933441720
EAN Code	4002395002030	4002395002023

M12 GG

M12™ SUB COMPACT GREASE GUN

M12



- Powerful 12 V motor delivers over 562 bar max operating pressure
- REDLINK™ overload protection electronics in tool and battery pack deliver best in class system durability
- Extreme long run time - dispenses up to 7 cartridges per charge
- Strong handle balance and ergonomics - only 355 mm long and 3.2 kg

M12 GG-0

M12 GG-401B

Kit included	No batteries supplied, No charger supplied, No kitbox or bag supplied	1 x M12 B4 Battery pack, C12 C Charger, Tool bag
Article Number	4933440435	4933441675
EAN Code	4002395000951	4002395001903

M12 PCG/600

M12™ SUB COMPACT CAULK GUN WITH 600 ML TUBE

M12



- Up to 1780 N of force
- REDLINK™ overload protection electronics in tool and battery pack deliver best in class system durability
- Optimised performance with all construction adhesives and cool temperatures
- Anti-drip feature prevents unwanted dripping when trigger is released
- Dial control with 6 speed settings allows for maximum bead control

M12 PCG/600A-0

M12 PCG/600A-201B

Kit included	No batteries supplied, No charger supplied, No kitbox or bag supplied	1 x M12 B2 Battery pack, C12 C Charger, Tool bag
Article Number	4933441786	4933441670
EAN Code	4002395002283	4002395001897

M12 PCG/400

M12™ SUB COMPACT CAULK GUN WITH 400 ML TUBE

M12



- Up to 1780 N of force
- REDLINK™ overload protection electronics in tool and battery pack deliver best in class system durability
- Optimised performance with all construction adhesives and cool temperatures
- Anti-drip feature prevents unwanted dripping when trigger is released
- Dial control with 6 speed settings allows for maximum bead control

M12 PCG/400A-0

M12 PCG/400A-201B

Kit included	No batteries supplied, No charger supplied, Tool bag	1 x M12 B2 Battery pack, C12 C Charger, Tool bag
Article Number	4933441780	4933441665
EAN Code	4002395002276	4002395001880

M12 PCG/310

M12™ SUB COMPACT CAULK GUN WITH 310 ML CARTRIDGE HOLDER

M12



- Up to 1780 N of force
- REDLINK™ overload protection electronics in tool and battery pack deliver best in class system durability
- Optimised performance with all construction adhesives and cool temperatures
- Anti-drip feature prevents unwanted dripping when trigger is released
- Dial control with 6 speed settings allows for maximum bead control

M12 PCG/310C-0

M12 PCG/310C-201B

Kit included	No batteries supplied, No charger supplied, No kitbox or bag supplied	1 x M12 B2 Battery pack, C12 C Charger, Tool bag
Article Number	4933441783	4933441655
EAN Code	4002395002269	4002395001866

M12 ATB

M12™ AUTOMOTIVE TECHNICIAN BORESCOPE

M12



- 4.3" LCD screen delivers sharp and clear images and allows users to see objects in greater detail
- 5.0 mm camera head allows great access to tight places like spark plug holes, fuel injector ports and cylinders
- Front and side view camera guarantees to identify hairline cracks and other issues on the engine and other areas of the vehicle

M12 ATB-0C

Kit included	No batteries supplied, No charger supplied, Kitbox
Article Number	4933493136
EAN Code	4058546480073

M12 FROS2.5 **M12 FUEL**
M12 FUEL™ 150 MM RANDOM ORBITAL SANDER WITH 2.5 MM ORBIT



- High performance motor delivers 6,400 to 24,000 sanding strokes per minute for faster material removal
- 2.5 mm orbit function for fine finishing and premium finish results
- Variable speed wheel with 8 speed settings allows the correct speed to be set for different types of material
- Compact and ergonomic design for fatigue-free working

	M12 FROS2.5-0	M12 FROS2.5-502X
Standard equipment	Universal vacuum adaptor, left-hand vacuum port, right-hand vacuum port	Universal vacuum adaptor, left-hand vacuum port, right-hand vacuum port
Kit included	No batteries supplied, No charger supplied, No kitbox or bag supplied	2 x M12 HB5 Battery packs, C12 C Charger, HD Box
Article Number	4933493647	4933493648
EAN Code	4058546485184	4058546485191



M12 FROS5 **M12 FUEL**
M12 FUEL™ 150 MM RANDOM ORBITAL SANDER WITH 5.0 MM ORBIT



- High performance motor delivers 6,400 to 24,000 sanding strokes per minute for faster material removal
- 5.0 mm orbit function for aggressive stock removal and fast sanding of fillers, primers and old paints
- Variable speed wheel with 8 speed settings allows the correct speed to be set for different types of material

	M12 FROS5-0	M12 FROS5-502X
Standard equipment	Universal vacuum adaptor, left-hand vacuum port, right-hand vacuum port	Universal vacuum adaptor, left-hand vacuum port, right-hand vacuum port
Kit included	No batteries supplied, No charger supplied, No kitbox or bag supplied	2 x M12 HB5 Battery packs, C12 C Charger, HD Box
Article Number	4933493650	4933493651
EAN Code	4058546485214	4058546485221



M12 BI **M12**
M12™ SUB COMPACT INFLATOR



- Compact lightweight design for fast inflation of car, light truck and compact equipment tires
- High efficiency motor & pump
- Anti-vibration stand with all rubber feet for no movement while inflating
- Auto shut-off technology inflates to users pre-selected pressure for highly accurate inflation
- Illuminated LCD display with a digital pressure and fuel gauge that displays remaining charge

	M12 BI-0
Kit included	No batteries supplied, No charger supplied, No kitbox or bag supplied
Article Number	4933464124
EAN Code	4058546220693

M12 SI **M12**
M12™ SUB COMPACT SOLDERING IRON



- Quick heat up time: the tool is ready to use in 20 - 30 seconds
- 3 locking head positions to work in multiple orientations - 0°, 45°, 90°
- Tool free replaceable tips
- Dual color LED lights to notify user: flashing green when tool is heating up, solid green when the tool is ready for operation and solid red when the tool is off but the tip is hot to touch until the red LED turns off

	M12 SI-0	M12 SI-201C
Kit included	No batteries supplied, No charger supplied, No kitbox or bag supplied	1 x M12 B2 Battery pack, C12 C Charger, Kitbox
Article Number	4933459760	4933459761
EAN Code	4058546029326	4058546029333

M12 FTB **M12 FUEL**
M12 FUEL™ LOW SPEED TYRE BUFFER



- The M12 FUEL™ low speed tyre buffer has a two-speed mode selector for reaming & buffing applications
- Optimal speed settings of 1200 RPM in first mode and 2500 RPM in second mode help to avoid burning the rubber and damaging the tyre
- Pneumatic performance with cordless convenience for better accessibility and manoeuvrability in tight spaces

	M12 FTB-0
Kit included	No batteries supplied, No charger supplied, No kitbox or bag supplied
Article Number	493347215
EAN Code	4058546326111

M12 BLROT **M12**
M12™ BRUSHLESS ROTARY TOOL

BRUSHLESS



- Compact and balanced in all orientation design allow the user to hold the tool close to the work piece
- Variable speed from 5000 rpm to 27,500 rpm with 12 speed settings allows the user to dial in the correct speed for each application
- 3.2 mm collet included, compatible with most common accessories
- Soft grip and low vibration allows user to work comfortably and for longer periods

	M12 BLROT-0
Kit included	No batteries supplied, No charger supplied, No kitbox or bag supplied
Article Number	4933493591
EAN Code	4058546484620

C12 RT

M12™ SUB COMPACT ROTARY TOOL

M12



- Versatile cordless solution for cutting and removal applications
- REDLINK™ overload protection electronics in tool and battery pack deliver best in class system durability
- Variable speed (5000 - 32,000 rpm)
- 3.2 mm collet fits most current accessories in the market
- Spindle lock mechanism for easy accessory changes

C12 RT-0

Kit included	No batteries supplied, No charger supplied, No kitbox or bag supplied
Article Number	4933427183
EAN Code	4002395239030

M12 FCOT

M12 FUEL™ SUB COMPACT MULTI-MATERIAL CUT-OFF TOOL

M12 FUEL



- Fast accurate cutting with up to 20,000 RPM
- Optimised ergonomic design for easy control and one-handed use. Only 1.1 kg and 226 mm in length
- Multi-material cutting capability with variety of blades available (metal cut-off wheel, carbide abrasive blade and diamond tile blade)
- A very capable problem solving tool for cutting steel, stainless steel, non-ferrous materials, drywall, fibre cement, plastic and ceramics

M12 FCOT-0

M12 FCOT-422X

Kit included	No batteries supplied, No charger supplied, No kitbox or bag supplied	1 x M12 B4, 1 x M12 B2 Battery packs, C12 C Charger, HD Box
Article Number	4933464618	4933464619
EAN Code	4058546225636	4058546225643

M12 FBS64

M12 FUEL™ SUB COMPACT BAND SAW WITH 64 MM CUTTING CAPACITY

M12 FUEL



- First 12V band saw with 64 mm cutting capacity on the market
- Compact light weight design, especially for cutting overhead with one hand in existing installations and in tight spaces
- Variable speed trigger for quick & easy speed adjustments
- Integrated blade cover protects user from injuries by preventing any access to the blade

M12 FBS64-0C

M12 FBS64-402C

Kit included	No batteries supplied, No charger supplied, Kitbox	2 x M12 B4 Battery packs, C12 C Charger, Kitbox
Article Number	4933478440	4933478441
EAN Code	4058546346317	4058546346324

M12 BS

M12™ SUB COMPACT BANDSAW

M12



- Compact light weight design for cutting with one hand overhead in existing installations and in tight spaces
- REDLINK™ overload protection electronics in tool and battery pack deliver best in class system durability
- Cuts a multitude of materials: steel, stainless steel, copper, plastic, aluminium
- Cold cutting - spark and burr free

M12 BS-0

M12 BS-402C

Kit included	No batteries supplied, No charger supplied, No kitbox or bag supplied	2 x M12 B4 Battery packs, C12 C Charger, Kitbox
Article Number	4933431310	4933441805
EAN Code	4002395240292	4002395002344

M12 FNB16

M12 FUEL™ 1.6 MM NIBBLER

M12 FUEL



- First 12V Nibbler with max. cutting capacity in mild Steel: 1.6 mm, in Stainless Steel: 1.2 mm, in Aluminium: 2.1 mm
- With only 1.6 kg (6.0 Ah battery included) it is the lightest cordless Nibbler on the market, while still outperforming 18V brushed competitors
- Maximum control for any material, with a 5-step speed dial it is ideal for working with stainless steel and aluminium

M12 FNB16-0X

M12 FNB16-402X

Kit included	No batteries supplied, No charger supplied, HD Box	2 x M12 B4 Battery packs, C12 C Charger, HD Box
Article Number	4933479618	4933479619
EAN Code	4058546374129	4058546374136

M12 FDGS

M12 FUEL™ STRAIGHT DIE GRINDER

M12 FUEL



- The first cordless in-line die grinder that delivers more power vs. pneumatic models
- Best-in-class size (262 mm long) to help reach in tight places, and offers great mobility and access
- Features a 3-mode speed control and responsive variable speed trigger enabling outstanding control
- To be used with discs up to Ø50 mm
- Supplied with 6 and 8 mm collets

M12 FDGS-0

M12 FDGS-422B

Kit included	No batteries supplied, No charger supplied, No kitbox or bag supplied	1 x M12 B4, 1 x M12 B2 Battery packs, C12 C Charger, Tool bag
Article Number	4933471435	4933471436
EAN Code	4058546290634	4058546290641

M12 FDGA

M12 FUEL™ ANGLED DIE GRINDER

M12 FUEL



- The first cordless right angle die grinder that delivers more power vs. pneumatic models
- Compact size (only 119 mm long) to help fit in tight places, and offers great mobility and access
- Features a 4-mode speed control and responsive variable speed trigger enabling outstanding control
- To be used with discs up to Ø50 mm
- Supplied with 6 and 8 mm collets

M12 FDGA-0

M12 FDGA-422B

Kit included	No batteries supplied, No charger supplied, No kitbox or bag supplied	1 x M12 B4, 1 x M12 B2 Battery packs, C12 C Charger, Tool bag
Article Number	4933471438	4933471439
EAN Code	4058546290665	4058546290672

M12 BPS

M12™ SUB COMPACT POLISHER / SANDER

M12



- Variable 2 speed selection (0-2800 / 0-8300 RPM) for both polishing and sanding applications
- REDLINK™ overload protection electronics in tool and battery pack deliver best in class system durability
- Large capacity of 76 mm polishing sponge and 50 mm sanding pad size for fast job completion

M12 BPS-0

M12 BPS-421X

Kit included	No batteries supplied, No charger supplied, No kitbox or bag supplied	1 x M12 B4, 1 x M12 B2 Battery packs, C12 C Charger, HD Box
Article Number	4933447791	4933447799
EAN Code	4002395006557	4002395006564

M12 FBFL10
M12 FUEL™ BAND FILE 10 MM



- Lightest cordless band file on the market, only 1.0 kg with a 2.0 Ah battery
- Outperforms pneumatic competitor while providing better balance
- 2 speed modes and variable speed trigger provide maximum control from taking down welds to precise work with inox, aluminium and wood

	M12 FBFL10-0	M12 FBFL10-402B
Kit included	No batteries supplied, No charger supplied, No kitbox or bag supplied	2 x M12 B4 Battery packs, C12 C Charger, Tool bag
Article Number	4933480958	4933480959
EAN Code	4058546412432	4058546412449

M12 FBFL13
M12 FUEL™ BAND FILE 13 MM



- Worlds first cordless 12V band file with a capacity of 13mm belt width
- Lightest cordless band file on the market, only 1.1 kg with a 2.0 Ah battery
- Outperforms pneumatic competitor while providing better balance
- 2 speed modes and variable speed trigger provide maximum control from taking down welds to precise work with inox, aluminium and wood

	M12 FBFL13-0	M12 FBFL13-402B
Kit included	2 x M12 B4 Battery packs, C12 C Charger, Tool bag	No batteries supplied, No charger supplied, No kitbox or bag supplied
Article Number	4933480960	4933480961
EAN Code	4058546412456	4058546412463

M12 FSDR75
M12 FUEL™ 75 MM RANDOM ORBIT SANDER



- High performance motor delivers 4,000 to 10,000 sanding strokes per minute with a 2.5 mm orbit allows for faster material removal
- Variable speed trigger with 4 speed settings allows the correct speed to be set for different types of material
- Small, compact and light weight, only 900 g, allows the users to easily work in tight or hard to reach place

	M12 FSDR75-0B	M12 FSDR75-202B
Kit included	No batteries supplied, No charger supplied, Hard case	2 x M12 B2 Battery packs, C12 C, Tool bag
Article Number	4933498232	4933498233
EAN Code	4058546521011	4058546521028



M12 FDSS
M12 FUEL™ SUB COMPACT SPOT SANDER



- Compact detail sander with a penta shaped pad allows uncompromised corner accessibility
- Four speed modes allows the correct speed to be set for different types of material
- Low vibration at only 4.3 m/s²
- Sponge interface pad included optimises the tool for profiles and contours which increases the precision and removal of material

	M12 FDSS-0B	M12 FDSS-422X
Kit included	No batteries supplied, No charger supplied, Tool bag	1 x M12 B4, 1 x M12 B2 Battery packs, C12 C Charger, HD Box
Article Number	4933479680	4933472681
EAN Code	4058546374747	4058546374754

M12 BCST
M12™ SUB COMPACT CABLE STAPLER



- The new battery powered cable stapler is twice as fast than manual staple installation. It eliminates majority of hand stapling of low voltage cable into wood
- Moveable cable guides ensure proper alignment over cable prior to fastening over a variety of cable sizes

	M12 BCST-0
Kit included	No batteries supplied, No charger supplied, No kitbox or bag supplied
Article Number	4933480488
EAN Code	4058546407735

M12 FMT
M12 FUEL™ MULTI-TOOL



- Brushless POWERSTATE™ motor delivers fast cutting speed through common materials without slowing or bogging down in hardwoods
- Adjustable 10,000 to 20,000 opm allow the user to get the perfect cut whatever the material
- Lowest vibration in its class, 4.56 m/s² driving productivity through performance and safety

	M12 FMT-0	M12 FMT-422X
Kit included	No batteries supplied, No charger supplied, No kitbox or bag supplied	1 x M12 B4, 1 x M12 B2 Battery packs, C12 C Charger, HD Box
Article Number	4933472238	4933472239
EAN Code	4058546326340	4058546326357

C12 MT
M12™ SUB COMPACT MULTI-TOOL



- Versatile cordless solution for cutting and removal applications
- REDLINK™ overload protection electronics in tool and battery pack deliver best in class system durability
- Variable speed (5000 - 20,000 rpm) and 1.5° left/right oscillation movement allows quick completion of professional applications into materials such as metal, wood and plastic
- Will accept competitor accessories

	C12 MT-0	C12 MT-202B	C12 MT-402B
Kit included	No batteries supplied, No charger supplied, No kitbox or bag supplied	2 x M12 B2 Battery packs, C12 C Charger, Tool bag	2 x M12 B4 Battery packs, C12 C Charger, Tool bag
Article Number	4933427180	4933441710	4933441705
EAN Code	4002395239276	4002395002009	4002395001989

M12 BLP M12™ BRUSHLESS PLANER

M12

BRUSHLESS



- M12™ Brushless Planer with a 2 mm planning depth and 51 mm planning width allows the tool to perform in the most common user applications
- Compact and light weight, comfortable to use in a variety of orientations and allows for one handed usage
- Dual-sided dust port for improved chip ejection to the left or right

	M12 BLP-0X	M12 BLP-402X
Kit included	No batteries supplied, No charger supplied, HD Box	2 x M12 B4 Battery packs, C12 C Charger, HD Box
Article Number	4933492850	4933492851
EAN Code	4058546477219	4058546477226

M12 FCS442 M12 FUEL™ SUB COMPACT CIRCULAR SAW

M12 FUEL



- Redesigned brushless POWERSTATE™ motor for up to 25% increase in performance when combined with MILWAUKEE® M12™ HIGH OUTPUT™ batteries
- Magnesium shoe reduces weight and maximises durability
- Integrated dust blower keeps cut line clear
- LED light illuminates the cut line for better visibility

	M12 FCS442-0	M12 FCS442-502X
Kit included	No batteries supplied, No charger supplied, No kitbox or bag supplied	2 x M12 HB5 Battery packs, C12 C Charger, HD Box
Article Number	4933493488	4933493489
EAN Code	4058546483593	4058546483609

M12 CHZ M12 FUEL™ SUB COMPACT HACKZALL™

M12 FUEL



- Counter balance mechanism lowers vibration to 6.5 m/s² allowing the operator to work safely for longer periods of time reducing fatigue
- Sealed gearbox prevents water and debris entering the housing
- Patented FIXTEC™ clamp for fast and easy keyless blade change
- LED light illuminates the cutline in low light conditions

	M12 CHZ-0	M12 CHZ-402C	M12 CHZ-602X
Kit included	No batteries supplied, No charger supplied, No kitbox or bag supplied	2 x M12 B4 Battery packs, C12 C Charger, Kitbox	2 x M12 B6 Battery packs, C12 C Charger, HD Box
Article Number	4933446960	4933446950	4933451511
EAN Code	4002395005727	4002395005710	4002395161591

C12 HZ M12™ SUB COMPACT HACKZALL™

M12



- High performance compact one handed use HACKZALL™, measuring only 280 mm in length, making it ideal for working within confined spaces
- REDLINK™ overload protection electronics in tool and battery pack deliver best in class system durability
- Patented FIXTEC™ clamp for fast and easy keyless blade change
- Low vibration at 10.5 m/s²

	C12 HZ-0	C12 HZ-202C
Kit included	No batteries supplied, No charger supplied, No kitbox or bag supplied	2 x M12 B2 Battery packs, C12 C Charger, Kitbox
Article Number	4933411925	4933441195
EAN Code	4002395236367	4002395001200

M12 FJS M12 FUEL™ BODYGRIP JIGSAW

M12 FUEL



- Delivering outstanding power, durability with a run time of up to 24 m in 19 mm OSB (on a 4.0 Ah battery pack)
- Patented FIXTEC™ blade clamp for fast and easy blade change
- 6-speed settings with auto controlled start mode allows the tool to start slow and ramp up to full speed when load is detected for smooth and accurate cut starts

	M12 FJS-0	M12 FJS-422X
Kit included	No batteries supplied, No charger supplied, No kitbox or bag supplied	1 x M12 B4, 1 x M12 B2 Battery packs, C12 C Charger, HD Box
Article Number	4933493347	4933493348
EAN Code	4058546482183	4058546482190

M12 FCN18GS M12 FUEL™ 18 GA STRAIGHT BRAD NAILER

M12 FUEL



- Fires 18 gauge straight nails with a 0° pitch in lengths from 16 mm - 38 mm
- Dry-Fire lockout stops the tool being fired when there are no nails left in the magazine
- Quick access for tool free jam removals
- Small work contact bracket allows the user to fire and sink nails at a more acute angle
- Smaller nail hole, the exact size of the nail head leaving a neater finish

	M12 FCN18GS-0X	M12 FCN18GS-202X
Kit included	No batteries supplied, No charger supplied, HD Box	2 x M12 B2 Battery packs, C12 C Charger, HD Box
Article Number	4933493354	4933493355
EAN Code	4058546482251	4058546482268

M12 BST M12™ SUB COMPACT STAPLER

M12



- Breakthrough performance limits user fatigue by eliminating the repetitive motion of hand tools
- Ready to Fire Technology eliminates ramp-up time between each staple discharge
- Bump fire and sequential fire operation allows the user to fire quickly and accurately
- 2000 staples fired with one 2.0 Ah battery pack
- Fires standard T11 T50 and T140 10.6 mm staples from 6 to 14 mm

	M12 BST-0	M12 BST-202X
Kit included	No batteries supplied, No charger supplied, No kitbox or bag supplied	2 x M12 B2 Battery packs, C12 C Charger, HD Box
Article Number	4933493634	4933493635
EAN Code	4058546028060	4058546028077



C12 PN
M12™ SUB COMPACT PALM NAILER

M12



- Professional power effectively drives 100 mm framing nails in less than 3 seconds
- REDLINK™ overload protection electronics in tool and battery pack deliver best in class system durability
- Superior ergonomics – user-preferred palm style grip provides outstanding comfort and control
- Fits into locations where a hammer cannot be swung

C12 PN-0

Kit included	No batteries supplied, No charger supplied, No kitbox or bag supplied
Article Number	4933427182
EAN Code	4002395239238

M12 AUN
M12™ AIR-TIP™ UTILITY NOZZLE

M12



- The M12™ powered utility nozzle is a great accessory that is designed to clean jobsite debris on short and medium hair carpeted surfaces
- The universal reception fits to all MILWAUKEE® M12™ and M18™ cordless vacs and covers most common hose sizes (Ø 31.8 mm, 47.6 mm and 63.5 mm)

M12 AUN-0

Kit included	No batteries supplied, No charger supplied, No kitbox or bag supplied
Article Number	4932479461
EAN Code	4058546372552

M12 FVCL
M12 FUEL™ WET/ DRY VACUUM

M12 FUEL



- Powerful M12 FUEL™ motor with a maximum air flow of 1275 l/min & 105 mbar provides 18V performance for both wet and dry clean up applications
- With a 6.0 Ah battery the vacuum provides 14 minutes of run time on high and 26 minutes on the low setting, this compact vacuum is ideal for spot and service focused wet/ dry quick clean up needs

M12 FVCL-0

Kit included	No batteries supplied, No charger supplied, No kitbox or bag supplied
Article Number	4933478186
EAN Code	4058546341190

M12 HV
M12™ SUB COMPACT STICK VAC

M12



- Excellent suction power for wood, metal and common debris
- Clear viewing window gives the user the ability to see debris build up
- Lock on switch reduces fatigue during sustained use
- Versatile accessories for small or large clean up areas
- Compact design makes it easy to clean in tight spaces

M12 HV-0

Kit included	No batteries supplied, No charger supplied, No kitbox or bag supplied
Article Number	4933448390
EAN Code	4002395262908

M12 BBL
M12™ BLOWER

M12



- Powerful motor can generate up to 4.81 m³ / min of air volume at 177 km/h for fast cleaning of the jobsite
- Lightweight, compact body clears dirt and debris in tight spaces
- Perfect control of the power with the 2 speed adjustable trigger
- Versatile attachments like the nozzle extension (25.5 cm) and a tip tube for accurate working are included

M12 BBL-0

Kit included	No batteries supplied, No charger supplied, No kitbox or bag supplied
Article Number	4933472214
EAN Code	4058546326104

M12 AF
M12™ AIR FAN

M12



- Three speed settings delivering max air speed of 22.53 km/h
- High efficient 150 mm blade diameter generates a maximum air volume of 680 m³/h
- The 360° head rotation allow an unlimited directional airflow
- Boundless hanging and mounting possibilities with the integrated magnets, key holes, hooks and pass through holes

M12 AF-0

Kit included	No batteries supplied, No charger supplied, No kitbox or bag supplied
Article Number	4933478228
EAN Code	4058546344054

M12 RCDAB+
M12™ RADIO CHARGER DAB+

M12



- Premium speaker and high frequency tweeter provides high sound quality
- DAB+ and AM/FM tuner with the digital processor delivers highest reception accuracy, signal clarity and additional information like: song, artist and accurate time
- Digital Bluetooth® receiver: Plays music up to 30 m away from your smartphone, computer or tablet

M12 RCDAB+-0

Kit included	No batteries supplied, No charger supplied, No kitbox or bag supplied
Article Number	4933472114
EAN Code	4058546325107

M12 SPEJSG2
M12™ JOBSITE SPEAKER

M12



- Advanced technology Bluetooth® job site speaker
- Bluetooth® 5.3 plays music up to 60 m away from your smartphone, computer or tablet
- Balanced & clear sound at all volumes
- Premium speaker with bass port
- Provides audio for small sized areas
- Audio link connects over 200 MILWAUKEE® M18 and M12 speakers

M12 SPEJSG2-0

Kit included	No batteries supplied, No charger supplied, No kitbox or bag supplied
Article Number	4933498433
EAN Code	4058546523022



M12 HJ5 M12™ HEATED JACKET



- Heat on demand - sewn in carbon fibre heating wires, distribute heat to core body areas and to the front pockets
- Superior run time, up to 8 hours of heat on low level with a single battery charge of an M12™ REDLITHIUM™ 3.0 Ah battery pack
- Easy touch heat controller - 3 heat settings: High, Medium, Low
- TOUGHSHELL™ stretch 90% polyester and 10% spandex material to withstand harsh working conditions and deliver up to 5x longer life
- FREE FLEX™ mobility - additional material under the arms increases range of movement for working overhead
- New battery pocket design providing users multiple options for battery placement, allowing adaptability to the situation
- Improved slim fit design with extended back prevents heat loss and keeps the user warm
- M12™ battery controller with 1 A USB port, to charge mobile devices stored in concealed battery pocket
- Water and wind resistant, provides comfort and durability in harsh environments
- Big hand & chest pocket, ideal for storing mobile devices

Black

Size	Name	Kit included	Article Number	EAN Code
S	M12 HJ BL5-0 (S)	No batteries supplied, No charger supplied, No kitbox or bag supplied	4933478967	4058546362492
M	M12 HJ BL5-0 (M)	No batteries supplied, No charger supplied, No kitbox or bag supplied	4933478968	4058546362508
L	M12 HJ BL5-0 (L)	No batteries supplied, No charger supplied, No kitbox or bag supplied	4933478969	4058546362515
XL	M12 HJ BL5-0 (XL)	No batteries supplied, No charger supplied, No kitbox or bag supplied	4933478970	4058546362522
XXL	M12 HJ BL5-0 (XXL)	No batteries supplied, No charger supplied, No kitbox or bag supplied	4933478971	4058546362539
XXXL	M12 HJ BL5-0 (XXXL)	No batteries supplied, No charger supplied, No kitbox or bag supplied	4933479362	4058546371562

Grey

Size	Name	Kit included	Article Number	EAN Code
S	M12 HJ GREY5-0 (S)	No batteries supplied, No charger supplied, No kitbox or bag supplied	4933478972	4058546362546
M	M12 HJ GREY5-0 (M)	No batteries supplied, No charger supplied, No kitbox or bag supplied	4933478973	4058546362553
L	M12 HJ GREY5-0 (L)	No batteries supplied, No charger supplied, No kitbox or bag supplied	4933478974	4058546362560
XL	M12 HJ GREY5-0 (XL)	No batteries supplied, No charger supplied, No kitbox or bag supplied	4933478975	4058546362577
XXL	M12 HJ GREY5-0 (XXL)	No batteries supplied, No charger supplied, No kitbox or bag supplied	4933478976	4058546362584
XXXL	M12 HJ GREY5-0 (XXXL)	No batteries supplied, No charger supplied, No kitbox or bag supplied	4933479363	4058546371579



M12 HJ CAMO6 M12™ HEATED CAMOUFLAGE JACKET



- REALTREE XTRA™ Camo pattern blends perfectly year round in a variety of habitats
- Quiet-shell stretch 100% polyester material to reduce noise during movement
- Heat on demand - 5 sewn in carbon fibre heating zones distribute heat to core body areas and to the front pockets
- Superior run time, up to 8 hours of heat on low level with a single battery charge of an M12™ REDLITHIUM™ 3.0 Ah battery pack
- Easy touch heat controller concealed inside the lapel - 3 heat settings: High, Medium, Low
- FREE FLEX™ mobility - additional material under the arms increases range of movement for working overhead
- Water and wind resistant, provides comfort and durability in harsh environments
- New battery pocket design providing users multiple options for battery placement, allowing adaptability to the situation
- Improved slim fit design with extended back prevents heat loss and keeps the user warm
- M12™ battery controller with 1 A USB port, to charge mobile devices stored in concealed battery pocket

	M12 HJ CAMO6-0 (S)	M12 HJ CAMO6-0 (M)	M12 HJ CAMO6-0 (L)	M12 HJ CAMO6-0 (XL)	M12 HJ CAMO6-0 (XXL)	M12 HJ CAMO6-0 (XXXL)
Kit included	No batteries supplied, No charger supplied, No kitbox or bag supplied	No batteries supplied, No charger supplied, No kitbox or bag supplied	No batteries supplied, No charger supplied, No kitbox or bag supplied	No batteries supplied, No charger supplied, No kitbox or bag supplied	No batteries supplied, No charger supplied, No kitbox or bag supplied	No batteries supplied, No charger supplied, No kitbox or bag supplied
Article Number	4933478977	4933478978	4933478979	4933478980	4933478981	4933479364
EAN Code	4058546362591	4058546362607	4058546362614	4058546362621	4058546362638	4058546371586

M12 HPJBL2

M12™ HEATED PUFFER JACKET - BLACK



- M12™ Heated Jacket powered by an M12™ battery with carbon fibre heating elements creates and distributes heat to chest, back and shoulders
- Superior run time, up to 11 hours of heat on a single battery charge of an M12™ REDLITHIUM™ 3.0 Ah battery pack
- Lightweight and highly durable ripstop polyester provides a slim design that can be worn as an outer-shell or a mid-layer (100% Polyester outer and inner shell)
- Reinforced high-wear zones protect from abrasion and tears
- Provides comfort and durability in harsh, rainy or windy environments
- Optimised hidden battery pocket to place M12™ battery in front or rear for increased comfort
- Multiple heating zones - 5 sewn in carbon fibre heating zones distribute heat to core body areas
- Easy one-touch heat controller - 3 heat settings: High, Medium, Low
- Machine washable and dryable

	M12 HPJBL2-0 (S)	M12 HPJBL2-0 (M)	M12 HPJBL2-0 (L)	M12 HPJBL2-0 (XL)	M12 HPJBL2-0 (XXL)
Kit included	No batteries supplied , No charger supplied , Gift box	No batteries supplied , No charger supplied , Gift box	No batteries supplied , No charger supplied , Gift box	No batteries supplied , No charger supplied , Gift box	No batteries supplied , No charger supplied , Gift box
Article Number	4932480071	4932480072	4932480073	4932480074	4932480075
EAN Code	4058546403560	4058546403577	4058546403584	4058546403591	4058546403607

M12 HPJLBL2

M12™ HEATED PUFFER JACKET LADIES - BLACK



- M12™ Heated Jacket powered by an M12™ battery with carbon fibre heating elements creates and distributes heat to chest, back and shoulders
- Superior run time, up to 11 hours of heat on a single battery charge of an M12™ REDLITHIUM™ 3.0 Ah battery pack
- Lightweight and highly durable ripstop polyester provides a slim design that can be worn as an outer-shell or a mid-layer (100% Polyester outer and inner shell)
- Reinforced high-wear zones protect from abrasion and tears
- Provides comfort and durability in harsh, rainy or windy environments
- Optimised hidden battery pocket to place M12™ battery in front or rear for increased comfort
- Multiple heating zones - 5 sewn in carbon fibre heating zones distribute heat to core body areas
- Easy one-touch heat controller - 3 heat settings: High, Medium, Low
- Machine washable and dryable

	M12 HPJLBL2-0 (S)	M12 HPJLBL2-0 (M)	M12 HPJLBL2-0 (L)	M12 HPJLBL2-0 (XL)	M12 HPJLBL2-0 (XXL)
Kit included	No batteries supplied , No charger supplied , No kitbox or bag supplied	No batteries supplied , No charger supplied , No kitbox or bag supplied	No batteries supplied , No charger supplied , No kitbox or bag supplied	No batteries supplied , No charger supplied , No kitbox or bag supplied	No batteries supplied , No charger supplied , No kitbox or bag supplied
Article Number	4932480085	4932480086	4932480087	4932480088	4932480089
EAN Code	4058546403706	4058546403713	4058546403720	4058546403737	4058546403744

M12 HPVBL2

M12™ HEATED PUFFER VEST



- M12™ Heated Jacket powered by an M12™ battery with carbon fibre heating elements creates and distributes heat to chest, back and shoulders
- Superior run time, up to 11 hours of heat on a single battery charge of an M12™ REDLITHIUM™ 3.0 Ah battery pack
- Lightweight and highly durable ripstop polyester provides a slim design that can be worn as an outer-shell or a mid-layer (100% Polyester outer and inner shell)
- Reinforced high-wear zones protect from abrasion and tears
- Provides comfort and durability in harsh, rainy or windy environments
- Optimised hidden battery pocket to place M12™ battery in front or rear for increased comfort
- Multiple heating zones - 3 sewn in carbon fibre heating zones distribute heat to core body areas
- Easy one-touch heat controller - 3 heat settings: High, Medium, Low
- Machine washable and dryable

	M12 HPVBL2-0 (S)	M12 HPVBL2-0 (M)	M12 HPVBL2-0 (L)	M12 HPVBL2-0 (XL)	M12 HPVBL2-0 (XXL)
Kit included	No batteries supplied, No charger supplied, Gift box	No batteries supplied, No charger supplied, Gift box	No batteries supplied, No charger supplied, Gift box	No batteries supplied, No charger supplied, Gift box	No batteries supplied, No charger supplied, Gift box
Article Number	4932480076	4932480077	4932480078	4932480079	4932480080
EAN Code	4058546403614	4058546403621	4058546403638	4058546403645	4058546403652

M12 HVGREY1

M12™ HEATED VEST - GREY



- M12™ Heated TOUGHSHHELL™ vest powered by an M12™ battery with carbon fibre heating elements creates and distributes heat to chest & back
- Superior run time, up to 11 hours of heat on a single battery charge of an M12™ REDLITHIUM™ 3.0 Ah battery pack
- TOUGHSHHELL™ stretch 90% Polyester and 10% spandex material to withstand harsh working conditions
- Optimised hidden battery pocket to place M12™ battery in front or rear for increased comfort
- Multiple heating zones - 3 sewn in carbon fibre heating zones distribute heat to core body areas
- Easy one-touch heat controller - 3 heat settings: High, Medium, Low
- Machine washable and dryable
- Battery holder included
- Flexible battery system: works with all MILWAUKEE® M12™ batteries

	M12 HVGREY1-0 (S)	M12 HVGREY1-0 (M)	M12 HVGREY1-0 (L)	M12 HVGREY1-0 (XL)	M12 HVGREY1-0 (XXL)	M12 HVGREY1-0 (XXXL)
Kit included	No batteries supplied, No charger supplied, Gift box	No batteries supplied, No charger supplied, Gift box	No batteries supplied, No charger supplied, Gift box	No batteries supplied, No charger supplied, Gift box	No batteries supplied, No charger supplied, Gift box	No batteries supplied, No charger supplied, Gift box
Article Number	4932480100	4932480101	4932480102	4932480103	4932480104	4932480105
EAN Code	4058546403850	4058546403867	4058546403874	4058546403881	4058546403898	4058546403904

M12 HH4 M12™ HEATED HOODIE



- M12™ Heated Hoodie powered by an M12™ battery with carbon fibre heating elements creates and distributes heat to chest and back
- Superior run time, up to 11 hours of heat on a single battery charge of an M12™ REDLITHIUM™ 3.0 Ah battery pack
- Rugged heated hoodie made from durable cotton (53%) exterior with durable reinforced utility pockets and polyester fleece (47%) lining to withstand tough outdoor conditions
- Optimised hidden battery pocket to place M12™ battery in front or rear for increased comfort
- In autumn and spring the hoodie can be worn as a rugged outer layer. In winter, it is best as a base layer that allows to shed bulky undergarments while generating and holding heat close to the body
- Multiple heating zones - 3 sewn in carbon fibre heating zones distribute heat to core body areas
- Easy one-touch heat controller - 3 heat settings: High, Medium, Low
- Integrated cell phone pocket

Black

Size	Name	Kit included	Article Number	EAN Code
S	M12 HHBL4-0 (S)	No batteries supplied, No charger supplied, Gift box	4932480061	4058546403461
M	M12 HHBL4-0 (M)	No batteries supplied, No charger supplied, Gift box	4932480062	4058546403478
L	M12 HHBL4-0 (L)	No batteries supplied, No charger supplied, Gift box	4932480063	4058546403485
XL	M12 HHBL4-0 (XL)	No batteries supplied, No charger supplied, Gift box	4932480064	4058546403492
XXL	M12 HHBL4-0 (XXL)	No batteries supplied, No charger supplied, Gift box	4932480065	4058546403508

Grey

Size	Name	Kit included	Article Number	EAN Code
S	M12 HHGREY4-0 (S)	No batteries supplied, No charger supplied, No kitbox or bag supplied	4932480066	4058546403515
M	M12 HHGREY4-0 (M)	No batteries supplied, No charger supplied, No kitbox or bag supplied	4932480067	4058546403522
L	M12 HHGREY4-0 (L)	No batteries supplied, No charger supplied, No kitbox or bag supplied	4932480068	4058546403539
XL	M12 HHGREY4-0 (XL)	No batteries supplied, No charger supplied, No kitbox or bag supplied	4932480069	4058546403546
XXL	M12 HHGREY4-0 (XXL)	No batteries supplied, No charger supplied, No kitbox or bag supplied	4932480070	4058546403553



M12 HHLBL1 M12™ HEATED LADIES HOODIE - BLACK



- M12™ Heated Hoodie for ladies powered by an M12™ battery with carbon fibre heating elements creates and distributes heat to chest and back
- Superior run time, up to 11 hours of heat on a single battery charge of an M12™ REDLITHIUM™ 3.0 Ah battery pack
- Optimised hidden battery pocket to place M12™ battery in front or rear for increased comfort
- Rugged heated hoodie made from durable cotton (53%) exterior with durable reinforced utility pockets and polyester fleece (47%) lining to withstand tough outdoor conditions
- In autumn and spring the hoodie can be worn as a rugged outer layer. In winter, it is best as a base layer that allows to shed bulky undergarments while generating and holding heat close to the body
- Multiple heating zones - 3 sewn in carbon fibre heating zones distribute heat to core body areas
- Easy one-touch heat controller - 3 heat settings: High, Medium, Low
- Integrated cell phone pocket

	M12 HHLBL1-0 (S)	M12 HHLBL1-0 (M)	M12 HHLBL1-0 (L)	M12 HHLBL1-0 (XL)
Kit included	No batteries supplied, No charger supplied, Gift box	No batteries supplied, No charger supplied, Gift box	No batteries supplied, No charger supplied, Gift box	No batteries supplied, No charger supplied, Gift box
Article Number	4932480090	4932480091	4932480092	4932480093
EAN Code	4058546403751	4058546403768	4058546403775	4058546403782

L4 HBLB USB RECHARGEABLE HEATED WORKSKIN™ BASE LAYER



- Mid-weight construction out of durable, pilling resistant material, keeps body warm and dry
- Fully heats-up in 2.5 min
- Heat is created and distributed to the chest and back
- Powered by L4 USB rechargeable REDLITHIUM™ battery pack
- A one-touch LED controller allows the user to select from 2 heat settings, delivering ideal heat for any environment
- Durable, pilling resistant material with raglan designed sleeves and seamless shoulders for improved mobility and comfort
- Superior run time - Up to 180 min of heat on low level
- L4 battery holder - concealed battery pocket for minimal user interference
- Machine washable

	L4 HBLB-301S	L4 HBLB-301M	L4 HBLB-301L	L4 HBLB-301XL	L4 HBLB-301XXL
Kit included	1 x L4 B3 Battery pack, No charger supplied, No kitbox or bag supplied	1 x L4 B3 Battery pack, No charger supplied, No kitbox or bag supplied	1 x L4 B3 Battery pack, No charger supplied, No kitbox or bag supplied	1 x L4 B3 Battery pack, No charger supplied, No kitbox or bag supplied	1 x L4 B3 Battery pack, No charger supplied, No kitbox or bag supplied
Article Number	4933478081	4933478082	4933478083	4933478084	4933478085
EAN Code	4058546340148	4058546340155	4058546340162	4058546340179	4058546340186

LASERS RANGE

SCAN HERE FOR MORE INFORMATION



M18 RLOHV1200

M18™ 1200 M HORIZONTAL VERTICAL AUTO DUAL GRADE ROTARY LASER WITH ONE-KEY™

M18



- The ultimate tool for grading applications
- Fast, accurate automatic dual grade match up to 12.5 % in X & Y axis, and can adjust slope remotely with a duplicated remote display
- Adjustable masking to prevent laser interference and laser reflection from windows at jobsite
- Designed for harsh jobsite conditions, IP66 rated and withstands up to 1.5 m drops

M18 RLOHV1200-501C

Standard equipment	1x RD1200, detector clamp, 1x remote control
Kit included	1 x M18 B5 Battery pack, M12-18 C Charger, Kitbox
Article Number	4933493204
EAN Code	4058546480752

M18 RLOH600

M18™ 600 M HORIZONTAL ROTARY LASER WITH ONE-KEY™

M18



- The ultimate tool for accurate results when leveling on the jobsite
- Easy to use, one button setup
- Manual masking shutters to prevent laser interference and laser reflection from windows
- Designed for harsh jobsite conditions, IP66 rated and withstands up to 1.5 m drops
- ±5° self levelling range for fast and accurate setup

M18 RLOH600-201C

Standard equipment	1x RD600, detector clamp
Kit included	1 x M18 B2 Battery pack, M12-18 C Charger, Kitbox
Article Number	4933493191
EAN Code	4058546480622

M18 RLOHVG300

M18™ 300 M GREEN HORIZONTAL VERTICAL ROTARY LASER WITH ONE-KEY™

M18



- Designed for interior and exterior jobs, for long distance applications
- Automatic centre find with one press off a button, for long range alignment
- High intensity green laser diode for maximised visibility; up to 4x better visibility vs red lasers
- Adjustable masking to prevent laser interference and laser reflection from windows
- Designed for harsh jobsite conditions, IP66 rated and withstands up to 1.5 m drops

M18 RLOHVG300-501C

Standard equipment	1x RD300G, detector clamp
Kit included	1 x M18 B5 Battery pack, M12-18 C Charger, Kitbox
Article Number	4933493194
EAN Code	4058546480653

M12 CLL4P

M12™ CROSS LINE LASER WITH 4 POINTS

M12



- M12™ green cross line laser with 4 points, provides an all-in-one functionality with horizontal levelling, vertical alignment, plumb point transfer from floor to ceiling and horizontal point transfer
- High intensity green beams provide a working range of 38 m and up to 100 m with a detector
- Provides all-day run time of 9+ hours with an M12 B3 battery pack

M12 CLL4P-0C

M12 CLL4P-301C

Standard equipment	Track clip, HVIST	Track clip, HVIST
Kit included	No batteries supplied, No charger supplied, Kitbox	1 x M12 B3 Battery pack, C12 C Charger, Kitbox
Article Number	4933479202	4933479203
EAN Code	4058546369965	4058546369972

M12 3PL

M12™ GREEN 360° 3 PLANE LASER

M12

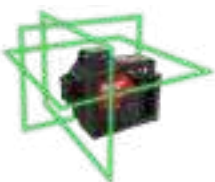

- M12™ green 360° 3 plane laser provides an all-in-one functionality with one horizontal line and two vertical lines for fast and easy alignment, leveling, squaring, and transfers allowing you to easily layout large spaces with one tool
- High intensity green laser diode for maximised visibility; up to 4x better visibility vs red lasers
- High intensity green beams provide a working range of 38 m and up to 100 m with a detector

	M12 3PL-0C	M12 3PL-401C	M12 3PLKIT-401P	M12 3PLSKIT-401P
Standard equipment	Track clip, HVIST	Track clip, HVIST	HVIST, LLD50, LM360, HVIST, TRP120, TRP120, Track Clip	Track Clip
Kit included	No batteries supplied, No charger supplied, Kitbox	1 x M12 B4 Battery pack, C12 C Charger, Kitbox	1 x M12 B4 Battery pack, C12 C Charger, PACKOUT™ box	1 x M12 B4 , C12 C , PACKOUT™ box
Article Number	4933478103	4933478102	4933478960	4933499379
EAN Code	4058546340360	4058546340353	4058546362423	4058546565435



M12 CLLP

M12™ GREEN CROSS LINE LASER WITH PLUMB POINTS



- M12™ green cross line laser with plumb points provides an all-in-one functionality with horizontal levelling, vertical alignment and plumb point transfer from floor to ceiling
- High intensity green laser diode for maximised visibility; up to 4x better visibility vs red lasers
- High intensity green beams provide a working range of 38 m and up to 100 m with a detector
- Provides all-day run time of 15+ hours with an M12 B3 battery pack

M12 CLLP-0C

Standard equipment	Track clip, HIVIST	M12 CLLP-301C	Track clip, HIVIST
Kit included	No batteries supplied, No charger supplied, Kitbox	M12 CLLP-301C	1 x M12 B3 Battery pack, C12 C Charger, Kitbox
Article Number	4933478101	M12 CLLP-301C	4933478100
EAN Code	4058546340346	M12 CLLP-301C	4058546340339

L4 CLLP

USB RECHARGEABLE GREEN CROSS LINE LASER WITH PLUMB POINTS



- REDLITHIUM™ USB rechargeable green cross line laser with plumb points provides an all-in-one functionality with horizontal levelling, vertical alignment and plumb point transfer from floor to ceiling
- High intensity green laser diode for maximised visibility; up to 4x better visibility vs red lasers
- High intensity green beams provide a working range of 30 m and up to 100 m with a detector

L4 CLLP-301C

Standard equipment	Track clip
Kit included	1 x L4 B3 Battery pack, USB cable and wall plug, Kitbox
Article Number	4933478099
EAN Code	4058546340322

L4 CLL

USB RECHARGEABLE GREEN CROSS LINE LASER



- REDLITHIUM™ USB rechargeable green cross line laser provides an all-in-one functionality with horizontal levelling and vertical alignment
- High intensity green laser diode for maximised visibility; up to 4x better visibility vs red lasers
- High intensity green beams provide a working range of 30 m and up to 100 m with a detector
- The rechargeable and removable REDLITHIUM™ USB 3.0 Ah battery provides all day run time of over 8 hours

L4 CLL-301C

Standard equipment	Track clip
Kit included	1 x L4 B3 Battery pack, USB cable and wall plug, Kitbox
Article Number	4933478098
EAN Code	4058546340315

CLL

ALKALINE GREEN CROSS LINE LASER



- Alkaline cross line laser provides an all-in-one functionality with horizontal levelling and vertical alignment
- High intensity green beams provide a working range of 30 m and up to 50 m with a detector
- The 4x AA alkaline batteries provides all day run time of over 8 hours

CLL-C

Standard equipment	Track clip
Kit included	4 x AA Batteries, Kitbox
Article Number	4933478753
EAN Code	4058546360351

RD1200

ROTARY LASER DETECTOR 1200 M



- 1200 m detection range in combination with the M18 RLOHV1200 laser, for long distance applications
- With automatic vertical and horizontal grade match and slope adjustment, the M18 RLOHV1200 laser will automatically align itself to the centre of the detector
- Easy-to-read, mm/in back and front backlit display, making it more visible for any application

RD1200

Kit included	2 x AA Batteries, No kitbox or bag supplied
Article Number	4932493207
EAN Code	4058546480783

RD600

ROTARY LASER DETECTOR 600 M



- 600 m detection range in combination with the M18 RLOH600 laser, for long distance applications
- Easy-to-read, mm/in back and front backlit display for clear visibility
- IP67 rated and withstands up to 2 m drops
- Adjustable accuracy at five steps from 0.5 mm to 10 mm
- LED and audio indication for the most versatile detector read out

RD600

Kit included	2 x AA Batteries, No kitbox or bag supplied
Article Number	4932493197
EAN Code	4058546480684

RD300G

ROTARY LASER DETECTOR 300 M GREEN



- 300 m detection range in combination with the M18 RLOHVG300 laser, for long distance applications
- The RD300G detector with integrated remote control allows the M18 RLOHVG300 laser to be controlled from distance
- Easy-to-read, mm/in back and front backlit display for clear visibility, whether used indoors or outdoors

RD300G

Kit included	2 x AA Batteries, No kitbox or bag supplied
Article Number	4932493198
EAN Code	4058546480691

LRD100

LINE/ ROTARY LASER DETECTOR



- The MILWAUKEE® LRD100 detector extends laser line functionality up to 100 metre in combination with all MILWAUKEE™ cross line and plane lasers and can be universally used with rotary lasers up to 250 metre radius
- The millimetre display on front and back allows easy and accurate detection of the laser beam to improve the set-up process
- Red and green laser diodes detection for most versatile use

LRD100

Kit included	1 x AA Battery, No kitbox or bag supplied
Article Number	493249555
EAN Code	4058546373498

LLD50 LASER LINE DETECTOR



- The MILWAUKEE® LLD50 laser line detector extends laser line functionality up to 50 metres
- The LEDs on front and back allow easy and accurate detection of the laser beam to improve the set-up process
- Rare earth magnets located on two sides of the detector allow it to easily attach to metal surfaces, ideal for suspended ceiling installations

LLD50

Kit included	1 x AA Battery, No kitbox or bag supplied
Article Number	4932478104
EAN Code	4058546340377

LM360 360° LASER MOUNT



- The MILWAUKEE® 360° laser mount is an adaptable laser attachment that provides the fastest laser setup
- Multi-plane rotational adjustment, users can easily attach all MILWAUKEE® lasers to the mount
- A micro vertical adjustment that makes aligning horizontal lines much faster

LM360

Article Number	4932478105
EAN Code	4058546340384

LWM LASER WALL MOUNT



- Vertical micro adjustment for most precise alignment during setup
- Hanghole and material clamp for most versatile setup at walls and ceilings
- Levelling adjustment screw to get laser in self levelling range
- Ruler scale to speed up setup and adjustment process
- Compatible with all MILWAUKEE® rotary lasers and M12™ line lasers in the range

LWM

Article Number	4932493201
EAN Code	4058546480721

HI-VIST HIGH VISIBILITY LASER TARGET PLATE



- The MILWAUKEE® high visibility laser target plate provides fast and visible alignment with a wide magnetic base for floors & ferrous surfaces
- High contrast reflective surface for use with green lasers
- The X design provides responsive centering feedback that guides the line to the centre, making the alignment process faster

HI-VIST

Article Number	4932478108
EAN Code	4058546340414

LMP 3.6 M TELESCOPING LASER POLE



- The MILWAUKEE® telescoping laser pole with 3.6 m extension range is ideal to setting up line lasers even on high ceilings
- The spring loaded swivel head makes setup easy, even at uneven surfaces
- The included quick release clamp opens to 6.3 cm and can be attached to round and square materials

LMP

Article Number	4932479205
EAN Code	4058546369996

WLB WIRELESS LASER ALIGNMENT BASE



- Precision horizontal motorised control with micro and macro alignment feature
- +38 m distance control to cover entire laser working range
- Pivots on point for faster setup when aligning two points
- Quick sliding attachment for fast and easy setup
- Intuitive pairing and control

WLB-C

Kit included	2 x AA Batteries, Kitbox
Article Number	4932479198
EAN Code	4058546369927

TRP300 3.0 METRE LASER TRIPOD



- Up to 2.95 m extension range for easy setup at most common working heights
- Most versatile setup in all environments with spiked feet and rubber feet
- 1.10 m elevation range to fine adjust the laser at height
- Shoulder strap for comfortable and hands-free transport, when carry the laser
- 3/8" standard threading to setup all rotary lasers and all MILWAUKEE® M12™ lasers

TRP300

Article Number	4932493200
EAN Code	4058546480714

TRP180 1.8 METER LASER TRIPOD



- The MILWAUKEE® laser tripod with a 1/4" mounting thread is ideal for setting the height of a horizontal laser line or elevating the laser when needed
- Height can be adjusted easily from 72 cm to 180 cm
- Laser can be mounted to the bottom of the tripod with the 360° mount (not included) for low level applications like socket installation

TRP180

Article Number	4932478106
EAN Code	4058546340391

TRP160 1.6 METRE LASER TRIPOD



- Up to 1.60 m extension range for easy setup at most common working heights
- Aluminium frame and steel feet to use at any jobsite condition
- Reinforced handle design for improved durability
- Shoulder strap for comfortable and hands-free transport, when carry the laser
- 5/8" standard threading to setup all rotary lasers and all MILWAUKEE® M12™ lasers

TRP160

Article Number	4932493199
EAN Code	4058546480707

TRP120 1.2 METER COMPACT LASER TRIPOD



- The MILWAUKEE® compact laser tripod with a 1/4" mounting thread and a flat head design is ideal for setting the height of a horizontal laser line or elevating the laser when needed
- Height can be adjusted easily from 47 cm to 120 cm
- 29 cm elevating range for fine adjusting the height

TRP120

Article Number	4932478959
EAN Code	4058546362416

SR240 240 CM STAFF ROD



- Metric elevation scale up to 2.4 m with integrated detector slider for a fast detector positioning
- Durable aluminium frame to withstand jobsite condition
- Durable endcaps to prevent frame damage
- Adjustable level vial for a more precise setup

SR240

Article Number	4932493202
EAN Code	4058546480738

ROD500 500 CM GRADE ROD



- Metric elevation scale up to 5 m for most common heights on jobsite
- Flat top endcap for a solid detector positioning
- Durable aluminium frame to withstand jobsite condition
- Durable endcaps to prevent frame damage
- Detachable level vial for a more precise setup

ROD500

Article Number	4932493203
EAN Code	4058546480745

LDM 100 100 M LASER DISTANCE METER



- Easy to use one person point and shoot system
- IP54 water & dust protection
- Metric & Imperial units of measurement
- Easy to touch measure buttons on the front and side of the housing to perform single measurements & continuous tracking

LDM 100

Kit included	2 x AAA Batteries, No kitbox or bag supplied
Article Number	4933459278
EAN Code	4058546002442

LDM 50 50 M LASER DISTANCE METER



- Easy to use one person point and shoot system
- Very slim housing design with belt clip for easy transport
- Area/volume/indirect height and patent pending surface measurement
- Min/Max sweep & continuous tracking
- Distance addition & subtraction for layouting
- Indirect height measurements (Pythagoras 2-point, 3-point, partial height)

LDM 50

Kit included	2 x AAA Batteries, No kitbox or bag supplied
Article Number	4933447700
EAN Code	4002395006540

LDM 45 45 M LASER DISTANCE METER



- Easy to use one person point and shoot system
- IP54 water & dust protection
- Metric & Imperial units of measurement
- Easy to touch measure buttons on the front and side of the housing
- Enables user to perform single measurements & continuous tracking

LDM 45

Kit included	2 x AAA Batteries, No kitbox or bag supplied
Article Number	4933459277
EAN Code	4058546002435

LDM 30 30 M LASER DISTANCE METER



- Easy to use one person point and shoot system
- IP54 water & dust protection
- Auto shut off and low power indication
- Metric & Imperial units of measurement
- Very slim housing design with belt clip for easy transport
- Two easy to touch measure buttons on the front and side of the housing

LDM 30

Kit included	2 x AAA Batteries, Blister packaging
Article Number	4933459276
EAN Code	4058546002428

ELECTRICAL

SCAN HERE FOR MORE INFORMATION



M18 HSFC125R M18™ FORCE LOGIC™ HYDRAULIC 125 MM SAFETY CABLE CUTTER

M18



- FORCE LOGIC™ Safety Cutter allows linemen to cut aluminium, copper and armored cables up to Ø125 mm remotely, removing any physical connection to the tool
- Enhanced remote control lets users start, pause and reverse the cutting blade all from a distanced position of complete safety
- Green LED lights on wireless remote gives positive indication that the cable is cut through blade positioning sensors

M18 HSFC125R-802C

Standard equipment	Remote control
Kit included	2 x M18 FB8 Battery packs, M12-18 FC Charger, Kitbox
Article Number	4933499331
EAN Code	4058546564957

M18 HCC125 M18™ FORCE LOGIC™ HYDRAULIC 125 MM CABLE CUTTER

M18



- FORCE LOGIC™ Hydraulic Cutter cuts aluminium, copper and armored cables up to Ø125 mm
- Adjustable side handle, in-line tool design and hang hook enable easiest set-up in trenches and vaults
- Quick Lock latch system allows users to easily open and close the latch without any hassle of alignment

M18 HCC125-801C

Kit included	1 x M18 FB8 Battery pack, M12-18 FC Charger, Kitbox
Article Number	4933499333
EAN Code	4058546564971

M18 HCC75R M18™ FORCE LOGIC™ HYDRAULIC REMOTE UNDERGROUND CABLE CUTTER

M18



- FORCE LOGIC™ hydraulic remote underground cable cutter cuts cables up to Ø75 mm in less than 10 seconds with 77.8 kN of force
- Wireless remote communicates with the tool via a mutually exclusive Bluetooth® connection, removing any physical connection to the tool and allowing Linemen to make remote cuts wirelessly
- Balanced design, handle and hang hook enable easiest set-up in vaults

M18 HCC75R-502C

Standard equipment	Remote control
Kit included	2 x M18 B5 Battery packs, M12-18 FC Charger, Kitbox
Article Number	4933459271
EAN Code	4058546002374

M18 HCC75 M18™ FORCE LOGIC™ HYDRAULIC UNDERGROUND CABLE CUTTER

M18



- FORCE LOGIC™ hydraulic underground cable cutter cuts cables up to Ø75 mm in less than 10 seconds with 77.8 kN of force
- Brushless POWERSTATE™ motor provides more power, more run time and longer life
- Versatile top-handle can also be used as a stand and provides balanced cut alignment
- In-line design delivers easiest access in trenches and a secure stand during cable cuts

M18 HCC75-0C

M18 HCC75-502C

Kit included	No batteries supplied, No charger supplied, Kitbox	2 x M18 B5 Battery packs, M12-18 FC Charger, Kitbox
Article Number	4933459268	4933459269
EAN Code	4058546002343	4058546002350

M18 HCC45 M18™ FORCE LOGIC™ HYDRAULIC 44 MM CABLE CUTTER

M18



- FORCE LOGIC™ hydraulic cable cutter cuts ACSR/ACSS cables up to Ø44 mm in less than 9 seconds with 77.8 kN of force
- Patent pending jaw design enables opening with just two fingers, enhancing alignment while delivering easiest operation with Class 3 gloves

M18 HCC45-0C

M18 HCC45-522C

Kit included	No batteries supplied, No charger supplied, Kitbox	1 x M18 B5, 1 x M18 B2 Battery packs, M12-18 FC Charger, Kitbox
Article Number	4933459265	4933459266
EAN Code	4058546002312	4058546002329

M12 CC M12™ SUB COMPACT CABLE CUTTER

M12



- Professional capacity Ø32 mm - powerful jaws cut effortlessly through large cable
- REDLINK™ overload protection electronics in tool and battery pack deliver best in class system durability
- Extended run time - delivers up to 60 cuts of 4 x 35 mm² copper per charge
- Compact front end - goes straight to the cable in panels or electrical cabinets without long handles looping or ratcheting

M12 CC-0

Kit included	No batteries supplied, No charger supplied, No kitbox or bag supplied
Article Number	4933431600
EAN Code	4002395242832

M18 ONEHCC

M18™ FORCE LOGIC™ HYDRAULIC 35 MM CABLE CUTTER

FORCELOGIC™

ONE KEY™
UNLOCKING THE DIGITAL JOBSITE



- FORCE LOGIC™ hydraulic cable cutter cuts cables in less than 3 seconds with 53 kN of force
- Brushless POWERSTATE™ motor provides more power, more run-time and longer life
- Fully balanced tool provides secure control during one hand operation
- One tool provides cutting solutions for ACSR wire, steel guy wire, fine stranded or standard copper and aluminium cable

SEE PAGE 134 OR SCAN TO VIEW OUR SYSTEM ATTACHMENTS FOR M18 ONEHCC - M18™ FORCE LOGIC™ HYDRAULIC 35 MM CABLE CUTTER



	M18 ONEHCC-0C CU/AL- SET	M18 ONEHCC-201C CU/AL-SET	M18 ONEHCC-0C ACSR SET	M18 ONEHCC-201C ACSR SET	M18 ONEHCC-0C FSW SET	M18 ONEHCC-201C FSW SET	M18 ONEHCC-0C SWA SET
Standard equipment	Cu/AL jaw	Cu/AL jaw	ACSR jaw	ACSR jaw	FSW jaw	FSW jaw	SWA jaw
Kit included	No batteries supplied, No charger supplied, Kitbox	1 x M18 B2 Battery pack, M12-18 C Charger, Kitbox	No batteries supplied, No charger supplied, Kitbox	1 x M18 B2 Battery pack, M12-18 C Charger, Kitbox	No batteries supplied, No charger supplied, Kitbox	1 x M18 B2 Battery pack, M12-18 C Charger, Kitbox	No batteries supplied, No charger supplied, Kitbox
Article Number	4933464300	4933464301	4933464303	4933464304	4933464308	4933464309	4933464306
EAN Code	4058546222451	4058546222468	4058546222482	4058546222499	4058546222536	4058546222543	4058546222512

M18 HKP

M18™ FORCE LOGIC™ HYDRAULIC KNOCKOUT PUNCH

FORCELOGIC™



- FORCE LOGIC™ hydraulic knockout punch is the most compact and lightweight tool on the market with 60 kN of force
- The easiest way to punch - for fast, accurate, round, and burr free holes
- Highest accuracy due to industry's finest exact alignment system for dies
- Best balanced tool and easiest control due to one hand operation

SEE PAGE 136 OR SCAN TO VIEW OUR SYSTEM ATTACHMENTS FOR M18 HKP - M18™ FORCE LOGIC™ HYDRAULIC KNOCKOUT PUNCH



	M18 HKP-201C	M18 HKP-201CA
Standard equipment	11.1mm (7/16") draw stud, 19mm (3/4") draw stud, quick connector, ball pull, adaptor	11.1mm (7/16") draw stud, 19mm (3/4") draw stud, quick connector, ball pull, adaptor, punches and dies: M16, M20, M25, M32, M40
Kit included	1 x M18 B2 Battery pack, M12-18 C Charger, Kitbox	1 x M18 B2 Battery pack, M12-18 C Charger, Kitbox
Article Number	4933451202	4933451204
EAN Code	4002395138906	4002395138920

M18 FPFT

M18 FUEL™ POWERED FISH TAPE



- The M18 FUEL™ Fish Tape is the world's first professional battery powered cable pulling solution
- POWERSTATE™ brushless motor that provides the ability to pull a maximum length of 72 m wire
- AUTO-RUN™ powered feeding and cable pulling is a fast and efficient solution providing higher productivity vs other solutions

SEE PAGE 135 OR SCAN TO VIEW OUR SYSTEM ATTACHMENTS FOR M18 FPFT - M18 FUEL™ POWERED FISH TAPE



	M18 FPFT-0	M18 FPFT-202 36m ST Set	M18 FPFT-202 30m NC Set
Kit included	No batteries supplied, No charger supplied, No kitbox or bag supplied	2 x M18 B2 Battery packs, M12-18 FC, No kitbox or bag supplied	2 x M18 B2 Battery packs, M12-18 FC, No kitbox or bag supplied
Article Number	4933471952	4933471953	4933471954
EAN Code	4058546298517	4058546298524	4058546298531

M18 HUP700

M18™ HYDRAULIC UTILITY PUMP

FORCELOGIC™

ONE KEY™
UNLOCKING THE DIGITAL JOBSITE



- FORCE LOGIC™ hydraulic utility pump powers every single acting 700 bar crimping, cutting or punching head attachment
- Significantly faster work cycles due to a large 1.6 litre total oil reservoir and 2x higher flow rate compared to other pumps
- The pump is equipped with a industry standard CEJN Series 115, G1/4" female quick connection coupler to suit most common attachments

SEE PAGE 136 OR SCAN TO VIEW OUR SYSTEM ATTACHMENTS FOR M18 HUP700 - M18™ HYDRAULIC UTILITY PUMP



	M18 HUP700-121
Kit included	1 x M18 FB12 Battery pack, M12-18 FC Charger, No kitbox or bag supplied
Article Number	4933499335
EAN Code	4058546564995



L4 HSL USB RECHARGEABLE HOT STICK LIGHT



TRUEVIEW™



- Fast and easy fuse cutouts
- Two separate LED lights providing 350 lumens of halo lighting on high
- Adjustable output levels give the ability to light the fuse for up to 10 hours on one full battery charge
- The LED hot stick light is built to survive in the toughest conditions and features a high impact aluminium body and IP54 rating for water and dust resistance

L4 HSL-301

Kit included	1 x L4 B3 Battery pack, USB cable, No kitbox or bag supplied
Article Number	4933493968
EAN Code	4058546511289

M18 HCCT109/42 M18™ FORCE LOGIC™ HYDRAULIC 109 KN CABLE CRIMPER



FORCELOGIC™

ONE KEY™
UNLOCKING THE DIGITAL JOBSITE.



- Lightest, most balanced tool with ergonomic grip design
- Red alignment marks on the tool jaws aid accuracy in crimp placement
- Crimps connectors up to 400 mm² with 109 kN of force
- 42 mm jaw opening and 350° head rotation provides easy positioning and access, even for large connectors

M18 HCCT109/42-522C

Kit included	1 x M18 B5, 1 x M18 B2 Battery packs, M12-18 FC Charger, Kitbox
Article Number	4933459273
EAN Code	4058546002398

M18 ONEHCCT60 M18™ FORCE LOGIC™ HYDRAULIC 60 KN CABLE CRIMPER



FORCELOGIC™

ONE KEY™
UNLOCKING THE DIGITAL JOBSITE.



- FORCE LOGIC™ hydraulic cable crimper crimps connectors up to 300 mm² in less than 5 seconds with 60 kN of force
- Easy die alignment and linear movement ensure most uniform crimp results
- Improved ergonomics and slim handle design provide for a comfortable one-handed operation

M18 ONEHCCT60-0C

M18 ONEHCCT60-202C

Kit included	No batteries supplied, No charger supplied, Kitbox	2 x M18 B2 Battery packs, M12-18 C Charger, Kitbox
Article Number	4933479683	4933479684
EAN Code	4058546374778	4058546374785

M18 HCCT M18™ FORCE LOGIC™ HYDRAULIC 53 KN CABLE CRIMPER



FORCELOGIC™

ONE KEY™
UNLOCKING THE DIGITAL JOBSITE.



- FORCE LOGIC™ hydraulic cable crimper crimps connectors up to 300 mm² in less than 3 seconds with 53 kN of force
- Revolutionary jaw holds connector for best alignment of cable and connector
- 2 in 1 solution: crimping jaw can be exchanged for an CU/AL cable cutting jaw
- Best balanced tool and easiest control due to one hand operation

M18 HCCT-201C

Kit included	1 x M18 B2 Battery pack, M12-18 C Charger, Kitbox
Article Number	4933451194
EAN Code	4002395138821

M18 HDCT M18™ FORCE LOGIC™ HYDRAULIC DIELESS CRIMPER



FORCELOGIC™

ONE KEY™
UNLOCKING THE DIGITAL JOBSITE.



- M18™ FORCE LOGIC™ HDCT crimps connectors on flexible wire from 10 to 300 mm² without changing dies
- Auto distance control continuously measures distance & pressure for uniform crimp appearance across every size of the crimping range
- 180° rotating head and easy access latch deliver easy alignment and free-up second hand to hold material

M18 HDCT-0C

M18 HDCT-202C

Kit included	No batteries supplied, No charger supplied, Kitbox	2 x M18 B2 Battery packs, M12-18 C Charger, Kitbox
Article Number	4933471949	4933471950
EAN Code	4058546298487	4058546298494

M18 BSBT M18™ SHEAR BOLT TOOL



- Huge capacity up to a cable size of 1000 mm² or connector diameter of 78 mm
- Outstanding power with a max torque of 100 Nm
- Universal compatibility with the industry leading shear bolt lug manufacturers
- IEC-Tested, superior electrical connection integrity of lug and cable thanks to smooth tightening of the screws without an impact mechanism

M18 BSBT-0X

M18 BSBT-202X

Standard equipment	9x Impact rated 1/2" sockets (10/17 mm socket, 13/19 mm socket long, 5/6/8 mm Hex socket, 6/8 mm Hex socket long), 2x fork attachment (33-52 mm, 58-69 mm)	9x Impact rated 1/2" sockets (10/17 mm socket, 13/19 mm socket long, 5/6/8 mm Hex socket, 6/8 mm Hex socket long), 2x fork attachment (33-52 mm, 58-69 mm)
Kit included	No batteries supplied, No charger supplied, HD Box	2 x M18 B2 Battery packs, M12-18 FC Charger, HD Box
Article Number	4933493288	4933493289
EAN Code	4058546481599	4058546481605

M18 BLTRC M18™ BRUSHLESS THREADED ROD CUTTER



BRUSHLESS



- M18™ brushless threaded rod cutter delivers a fast and effortless solution for cutting threaded rods
- Integrated brushless motor provides the user the power to cut through M6, M8, M10 and M12 mild steel or M6, M8 and M10 stainless steel threaded rod, with a run time of up to 300 cuts with a 2.0 Ah battery

M18 BLTRC-0X

M18 BLTRC-522X

Standard equipment	M6, M8, M10, M12 cutting dies	M6, M8, M10, M12 cutting dies
Kit included	No batteries supplied, No charger supplied, HD Box	1 x M18 B5, 1 x M18 B2 Battery packs, M12-18 C Charger, HD Box
Article Number	4933471150	4933471151
EAN Code	4058546287788	4058546287795



2205-40 FORK METER FOR ELECTRICIANS



- TRMS always guarantees accurate readings
- High contrast, easy to read display provides clearer readings
- Built-in non-contact voltage detector
- CAT III 1000 V/CAT IV 600 V for increased safety
- Rugged over-moulding for increased durability and grip
- Built-in LED work light – lights the work area
- Side mounted dial for one-handed use

2205-40

Kit included	2 x AA Batteries, Tool bag
Article Number	4933416972
EAN Code	4002395238026

2212-20 AUTO VOLTAGE / CONTINUITY TESTER



- Provides measurements down to decimals and displays them on an easy-to-read backlit LCD
- Automatically determines the need for voltage or continuity tests and display all measurements with proper resolution
- Compatible with accessories for carrying or mounting
- LED worklight for low lit areas
- Dual LED and audible indicators for fast and convenient test results

2212-20

Kit included	2 x AAA Batteries, No kitbox or bag supplied
Article Number	4933447776
EAN Code	4002395006526

2216-40 LIGHT COMMERCIAL MULTIMETER



- TRMS always guarantees accurate readings
- CAT III 600 V for increased safety
- Rugged over-moulding increases durability and user grip
- Side mounted dial for one-handed use
- Feature set tailored to electrician – for intuitive use
- Auto range to mV
- Supplied with electrical test lead set and 2 x AA batteries

2216-40

Kit included	2 x AA Batteries, No kitbox or bag supplied
Article Number	4933427309
EAN Code	4002395240128

2217-40 DIGITAL MULTIMETER



- TRMS always guarantees accurate readings
- High contrast, easy to read display provides clearer readings
- Cat III 600 V for increased safety
- Side mounted dial for one-handed use
- Feature set tailored to electrician – for intuitive use
- Lo-Z. – always guaranteed accurate readings
- Versatile contact temperature measurement
- Slide rail for accessory mount

2217-40

Kit included	2 x AA Batteries, Tool bag
Article Number	4933416976
EAN Code	4002395238064

2235-40 LIGHT COMMERCIAL CLAMP METER



- TRMS always guarantees accurate readings
- CAT III 600 V for increased safety
- Rugged over-moulding increases durability and user grip
- Built-in LED work light – lights the work area
- Side mounted dial for one-handed use
- Thin jaw profile for easier wire measurement in panels or in bundles
- Supplied with electrical test lead set and 2 x AA batteries

2235-40

Kit included	2 x AA Batteries, No kitbox or bag supplied
Article Number	4933427315
EAN Code	4002395240135

2267-40 10:1 INFRARED TEMP-GUN™



- 10:1 distance to spot ratio, a 1 m spot from 10 m away
- Up to -30°C to 400°C temperature range
- Premium LCD display for high readability
- Simplified buttons and setup for faster scanning
- Raised overmolding protects lens and screen from direct impact

2267-40

Kit included	2 x AA Batteries, No kitbox or bag supplied
Article Number	4933451906
EAN Code	4002395282159

2200-40 VOLTAGE DETECTOR



- Wide 50 - 1000 AC voltage range
- CAT IV 1000 V for highest safety rating
- Tip for checking outlets
- Green light indicates tool is on
- Loud beeper indicates voltage
- Blinking red light indicates voltage
- On/Off button
- Pocket clip for easy storage

2200-40

Kit included	2 x AAA Batteries, No kitbox or bag supplied
Article Number	4932352561
EAN Code	4002395372195

2225-20 NON CONTACT VOLTAGE DETECTOR WITH LASER THERMOMETER



- Wide measurement range from 12 -1000V, AC
- CAT IV 1000 V safety rating
- Infrared laser thermometer with -30°C - 250°C range
- Highly visible red indicator LED shows presence of voltage
- Additional audible indicator supports voltage detection through beeping sound
- Green light indicates tool is turned on
- IP 54 rating

2225-20

Kit included	2 x AAA Batteries, No kitbox or bag supplied
Article Number	4932498859
EAN Code	4058546527280

PLUMBING

SCAN HERE FOR MORE INFORMATION



M18 ONEBLHPT M18™ FORCE LOGIC™ BRUSHLESS PRESS TOOL WITH ONE-KEY™



FORCELOGIC™



- Compact brushless motor in FORCE LOGIC™ press tools delivers up to 10 % faster connections and 20 % more run time
- FORCE LOGIC™ press indicator: provides visual confirmation of a quality connection
- One hand operated tool for over head applications and working in narrow spaces
- Tool records & stores every press made. ONE-KEY™ enabled for professional report buildings via ONE-KEY™ app or ONE-KEY™ browser version
- ONE-KEY™ tool tracking & security offers a cloud-based inventory management platform that supports both location tracking and theft prevention
- FORCE LOGIC™ long life reliability: No press cycle limitation within the 3 year maintenance interval
- Allows to press system related up to 108 mm metal pipes and 110 mm composite pipes
- Universal jaw reception to fit most common jaws available on the market
- Auto-Cycle ensures a full press cycle is completed with every press connection



	M18 ONEBLHPT-OC	M18 ONEBLHPT-302C	M18 ONEBLHPT-302C TH-SET	M18 ONEBLHPT-302C V-SET	M18 ONEBLHPT-302C U-SET	M18 ONEBLHPT-302C M-SET	M18 ONEBLHPT-302C Geberit Mapress Set
Standard equipment	-	-	3 x TH-profile jaws (16/20/323 x V-profile jaws (15/22/28 mm)	3 x U-profile jaws (16/20/25 mm)	3 x M-profile jaws (15/22/28 mm)	3 x Geberit Licensed Ma-	3 x Geberit Licensed Ma-
Kit included	No batteries supplied, No charger supplied, Kitbox	2 x M18 HB3 Battery packs, M12-18 FC Charger, Kitbox	2 x M18 HB3 Battery packs, M12-18 FC Charger, Kitbox	2 x M18 HB3 Battery packs, M12-18 FC Charger, Kitbox	2 x M18 HB3 Battery packs, M12-18 FC Charger, Kitbox	2 x M18 HB3 Battery packs, M12-18 FC Charger, Kitbox	2 x M18 HB3 Battery packs, M12-18 FC Charger, Kitbox
Article Number	4933478305	4933478306	4933478307	4933478308	4933478309	4933478310	4933480904
EAN Code	4058546344825	4058546344832	4058546344986	4058546344993	4058546345006	4058546345013	4058546411893

M18 BLHPT M18™ FORCE LOGIC™ BRUSHLESS PRESSTOOL



FORCELOGIC™

- New compact brushless motor in FORCE LOGIC™ press tools delivers up to 10% faster connections and 20% more runtime
- FORCE LOGIC™ press indicator: provides visual confirmation of a quality connection
- One hand operated tool for over head applications and working in narrow spaces
- Most compact in-line design with 13% less weight for easy operation
- Battery-tool communication: press operation doesn't start to prevent incomplete pressing in case of low charged battery. Pre-press battery check ensures enough charge to complete each press
- FORCE LOGIC™ long life reliability: No press cycle limitation within the 3 year maintenance interval
- Allows to press system related up to 108 mm metal pipes and 110 mm composite pipes
- Universal jaw reception to fit most common jaws available on the market
- On board fuel gauge and LED light



	M18 BLHPT-OC	M18 BLHPT-202C	M18 BLHPT-202C M-SET	M18 BLHPT-202C V-SET	M18 BLHPT-202C TH-SET	M18 BLHPT-202C U-SET	M18 BLHPT-202C Geberit Mapress Set
Standard equipment	-	-	3 x M-profile jaws (15/22/28 mm)	3 x V-profile jaws (15/22/28 mm)	3 x TH-profile jaws (16/20/323 x U-profile jaws (16/20/25 mm)	3 x Geberit Licensed Ma-	3 x Geberit Licensed Ma-
Kit included	No batteries supplied, No charger supplied, Kitbox	2 x M18 B2 Battery packs, M12-18 C Charger, Kitbox	2 x M18 B2 Battery packs, M12-18 C Charger, Kitbox	2 x M18 B2 Battery packs, M12-18 C Charger, Kitbox	2 x M18 B2 Battery packs, M12-18 C Charger, Kitbox	2 x M18 B2 Battery packs, M12-18 C Charger, Kitbox	2 x M18 B2 Battery packs, M12-18 C Charger, Kitbox
Article Number	4933478248	4933451132	4933451133	4933451134	4933451135	4933451136	4933480903
EAN Code	4058546344252	4002395138012	4002395138029	4002395138036	4002395138043	4002395138050	4058546411886

M18 BLHPTXL M18™ FORCE LOGIC™ BRUSHLESS XL PRESS TOOL



FORCELOGIC™

- New compact brushless motor in FORCE LOGIC™ press tools delivers up to 10% faster connections and 20% more run time
- FORCE LOGIC™ press indicator: provides visual confirmation of a quality connection
- Extended press range up to 108 mm in copper, C- steel & stainless steel & up to 4" in steel pipe
- One hand operated tool for over head applications and working in narrow spaces
- Adjustable stroke length allows usage of all standard MILWAUKEE® J18 jaws + most common competitive jaws available on the market
- FORCE LOGIC™ long life reliability: No press cycle limitation within the 3 year maintenance interval
- Auto-cycle ensures a full press cycle is completed with every press connection
- Battery-tool communication: press operation doesn't start to prevent incomplete pressing in case of low charged battery. Pre-press battery check ensures enough charge to complete each press
- On board fuel gauge and LED light



	M18 BLHPTXL-OC	M18 BLHPTXL-502C
Kit included	No batteries supplied, No charger supplied, PACKOUT™ box	2 x M18 B5 Battery packs, M12-18 C Charger, PACKOUT™ box
Article Number	4933479440	4933479441
EAN Code	4058546372347	4058546372354

M12 ONEHPT M12™ SUB COMPACT FORCE LOGIC™ HYDRAULIC PRESS TOOL WITH ONE-KEY™

FORCELOGIC™ **ONE-KEY™**
UNLOCKING THE DIGITAL JOBSITE.



- Small, lightweight press tool: weighs only 1.8 kg for greater user comfort
- Tool records & stores every press made. ONE-KEY™ enabled for professional report buildings via ONE-KEY™ app
- 180° rotating head provides maximum flexibility for work in confined spaces
- FORCE LOGIC™ press indicator: provides visual confirmation of a quality connection
- Patented one hand operation allows to work in restricted areas
- Outstanding pressing range up to 35 mm metal and 40 mm composite pipes
- Battery-tool communication: pre-press battery check ensures press operation doesn't start to prevent incomplete pressing in case of low charged battery
- 4-step and precise battery status indicator
- FORCE LOGIC™ long life reliability: No press cycle limitation within the 3 year maintenance interval

	M12 ONEHPT-0C	M12 ONEHPT-202C	M12 ONEHPT-202C M-Set	M12 ONEHPT-202C V-Set	M12 ONEHPT-202C V-Set 2	M12 ONEHPT-202C TH-Set	M12 ONEHPT-202C U-Set	M12 ONEHPT-202C Geberit Mapress Set
Standard equipment	-	-	3 x M-profile press jaws (15, 22, 28 mm)	3 x V-profile press jaws (15, 22, 28 mm)	3 x V-profile press jaws (14, 16, 22 mm)	3 x TH-profile press jaws (16, 20, 26 mm)	3 x U-profile press jaws (16, 20, 25 mm)	3 x Geberit Licensed Mapress jaws (15, 22, 28 mm)
Kit included	No batteries supplied, No charger supplied, Kitbox	2 x M12 B2 Battery packs, C12 C Charger, Kitbox	2 x M12 B2 Battery packs, C12 C Charger, Kitbox	2 x M12 B2 Battery packs, C12 C Charger, Kitbox	2 x M12 B2 Battery packs, C12 C Charger, Kitbox	2 x M12 B2 Battery packs, C12 C Charger, Kitbox	2 x M12 B2 Battery packs, C12 C Charger, Kitbox	2 x M12 B2 Battery packs, C12 C Charger, Kitbox
Article Number	4933481031	4933481032	4933481033	4933481034	4933481035	4933481036	4933481037	4933481038
EAN Code	4058546413163	4058546413170	4058546413187	4058546413194	4058546413200	4058546413217	4058546413224	4058546413231

SEE PAGES 112 - 115 OR SCAN TO VIEW OUR M12™ AND M18™ PRESS JAWS

MXF PTR2 MX FUEL™ PIPE THREADING MACHINE 2" WITH ONE-KEY™

ONE-KEY™
UNLOCKING THE DIGITAL JOBSITE.



- Threading capacity from 1/8" all the way up to 2"
- One stop shop: Cut, Ream and Thread with one tool
- Outstanding performance with 2 speed settings of 39 RPM and 59 RPM matching corded speed
- Maximum mobility thanks to foldable wheel cart with tool free setup
- Integrated auto oil system with oil pump and reservoir

	MXF PTR2-0	MXF PTR2-601
Standard equipment	1/2"-3/4" BSPT HS die set, 1"-2" BSPT HS die set	1/2"-3/4" BSPT HS die set, 1"-2" BSPT HS die set
Kit included	No batteries supplied, No charger supplied, No kitbox or bag supplied	1 x MXF XCA06 Battery pack, MXF C Charger, No kitbox or bag supplied
Article Number	4933498324	4933492100
EAN Code	4058546521936	4058546414672

M18 FPT2 M18 FUEL™ PIPE THREADER 2" WITH ONE-KEY™

ONE-KEY™
UNLOCKING THE DIGITAL JOBSITE.



- World's first 18V 2" pipe threader on the market that is fully universal with competitive die heads. It threads pipes from 1/8" up to 2"
- Unique to MILWAUKEE®, pipe threader with AUTO-STOP™ kickback control, senses binding and shuts tool off to provide the user with more safety

	M18 FPT2-0C	M18 FPT2-121C
Standard equipment	1x support arm	1x support arm
Kit included	No batteries supplied, No charger supplied, Kitbox	1 x M18 FB12 Battery pack, M12-18 FC Charger, Kitbox
Article Number	4933478596	4933499200
EAN Code	4058546347895	4058546563646

SEE PAGE 105 OR SCAN TO VIEW OUR PIPE THREADER DIES

M18 FPT114 M18 FUEL™ PIPE THREADER 1 1/4" WITH ONE-KEY™

ONE-KEY™
UNLOCKING THE DIGITAL JOBSITE.



- Wide threading capacity from 1/8" up to 1 1/4"
- Unique to MILWAUKEE®, pipe threader with AUTOSTOP™ kickback control, senses binding and shuts tool off to provide the user with more safety
- Low weight and compact size allows convenient usage on installed pipes in confined spaces
- Compatible with new MILWAUKEE® FPT114H die heads and Ridgid 11R heads until 1 1/4"

	M18 FPT114-0C	M18 FPT114-802C	M18 FPT114-802CA
Included heads	-	-	4x BSPT alloy heads (1/2" / 3/4" / 1" / 1 1/4")
Standard equipment	1x support arm	1x support arm	1x support arm, 4x BSPT alloy heads (1/2" / 3/4" / 1" / 1 1/4")
Kit included	No batteries supplied, No charger supplied, Kitbox	2 x M18 FB8 Battery packs, M12-18 FC Charger, Kitbox	2 x M18 FB8 Battery packs, M12-18 FC Charger, Kitbox
Article Number	4933480220	4933499198	4933499199
EAN Code	4058546405052	4058546563622	4058546563639

SEE PAGE 106 OR SCAN TO VIEW OUR PIPE THREADER HEADS

MPS
MILWAUKEE® PIPE STAND



- Worlds first pipe stand, that is flat foldable, which allows for easier transportation and more efficient storage
- Able to clamp materials, such as pipe, strut, channel, angled iron and other materials, up to 165 mm or 6"
- The MILWAUKEE® pipe stand can be used with threaders, angle grinders, sawzalls, hackzalls, metal circular saws and various other tools

MPS

Article Number	4933472022
EAN Code	4058546324186

SEE PAGE 140 OR SCAN TO VIEW OUR ACCESSORIES FOR MPS - MILWAUKEE® PIPE STAND



M12 PCSS54
M12™ RAPTORXL™ PIPE CUTTER STAINLESS STEEL



- The MILWAUKEE® RAPTORXL™ is able to cut installed pipe in stainless steel, c-steel and copper
- High performance 330 rpm motor cuts 54 mm stainless steel pipe in less than 30 seconds
- Up to 45 cuts with one M12™ 4.0 Ah battery pack
- Auto locking cut mechanism cuts installed pipe with as little as 43 mm clearance

M12 PCSS54-0

M12 PCSS54-402C

Standard equipment	1x spare blade, 1x retaining clip, 1x oil tube	1x spare blade, 1x retaining clip, 1x oil tube
Kit included	No batteries supplied, No charger supplied, No kitbox or bag supplied	2 x M12 B4 Battery packs, C12 C Charger, Kitbox
Article Number	4933498374	4933498605
EAN Code	4058546522438	4058546524746



M12 PCSS
M12™ RAPTOR™ PIPE CUTTER STAINLESS STEEL



- The MILWAUKEE® RAPTOR™ is the worlds first 12V pipe cutter that is able to cut installed pipe in stainless steel, c-steel and copper
- High performance 380 rpm motor cuts 28 mm stainless steel pipe in less than 13 seconds
- Up to 150 cuts in 15 mm stainless steel with one M12™ 2.0 Ah battery pack
- Auto locking cut mechanism cuts installed pipe with as little as 40 mm clearance

M12 PCSS-0

M12 PCSS-202C

Kit included	No batteries supplied, No charger supplied, No kitbox or bag supplied	2 x M12 B2 Battery packs, C12 C Charger, Kitbox
Article Number	4933479241	4933479242
EAN Code	4058546370350	4058546370367

C12 PPC
M12™ SUB COMPACT PEX CUTTER



- Massive cutting pressure of 175 kg/cm²
- REDLINK™ overload protection electronics in tool and battery pack deliver best in class system durability
- Powerful mechanism cuts up to 50 mm PVC pipe in 3 seconds
- Heavy Duty full metal gearbox and gears for superior durability and maximum torque
- Variable speed trigger for complete cut out control

C12 PPC-0

Kit included	No batteries supplied, No charger supplied, No kitbox or bag supplied
Article Number	4933416550
EAN Code	4002395237203

C12 PC
M12™ SUB COMPACT COPPER PIPE CUTTER



- High performance 500 rpm motor cuts 12 mm copper pipe in less than 3 seconds
- REDLINK™ overload protection electronics in tool and battery pack deliver best in class system durability
- Auto locking cut mechanism cuts installed copper tubing with as little as 40 mm clearance
- Auto adjusting jaws automatically adjust to pipe size

C12 PC-0

Kit included	No batteries supplied, No charger supplied, No kitbox or bag supplied
Article Number	4933411920
EAN Code	4002395236374

SEE PAGE 134 OR SCAN TO VIEW OUR SYSTEM ATTACHMENTS FOR PIPE CUTTERS



M18 STSO

M18™ FORCE LOGIC™ STRUT SHEAR

M18

FORCELOGIC™

ONE KEY™
UNLOCKING THE DIGITAL JOB SITE.



- Cleanest and safest way to cut strut profiles
- Compatible with 41x41 mm, 41x21 mm, 41x22 mm strut
- Compatible with commonly available strut manufacturers in the specified dimensions
- Shears pre- and hot dipped galvanised strut until 3.0 mm wall thickness
- All day run time of over 200 cuts on a single M18™ 5.0 Ah battery
- Cuts 41x41 mm strut in under 5 seconds

M18 STSO-0B

Kit included	No batteries supplied, No charger supplied, Tool bag
Article Number	4933492097
EAN Code	4058546414641



M18 BLSWP

M18™ HYDROPASS™ BRUSHLESS STICK WATER PUMP

M18

BRUSHLESS

- HYDROPASS™ unique filter system prevents blocking of the inlet and allows the user to pump water at all times, regardless of the debris encountered
- Effortlessly pump up to 5,670 litres per hour
- Submersible up to 107 cm allows users to easily pump deep puddles of water with a maximum head height of 5.1 metres
- IPX4 battery compartment protects all M18™ batteries



M18 BLSWP-0

M18 BLSWP-801

Kit included	No batteries supplied, No charger supplied, No kitbox or bag supplied	1 x M18 FB8 Battery, M12-18 FC Charger, No kitbox or bag supplied
Article Number	4933498559	4933498560
EAN Code	4058546524289	4058546524296



2267-40

10:1 INFRARED TEMP-GUN™

M12

- HYDROPASS™ unique filter system, prevents blocking of the inlet and allows the user to pump water at all times, regardless of the debris encountered
- Pumps more than 2000 l/hour and up to 1000 l on 1x M12™ 6.0 Ah battery, perfect for emptying trenches, storm drains, outside meter boxes, rain barrels and various other applications



- 10:1 distance to spot ratio, a 1 m spot from 10 m away
- Up to -30°C to 400°C temperature range
- Premium LCD display for high readability
- Simplified buttons and setup for faster scanning
- Raised overmolding protects lens and screen from direct impact

2267-40

Kit included	2 x AA Batteries, No kitbox or bag supplied
Article Number	4933451906
EAN Code	4002395282159

SEE PAGE 135 OR SCAN TO VIEW
OUR SYSTEM ATTACHMENTS
FOR STRUT SHEAR



M18 BTP

M18™ COMPACT TRANSFER PUMP

M18



- 18V transfer pump with 3.4 kg in weight, it's lighter than other corded transfer pumps with an equal performance
- With a flow rate of 1817 l/h, it can deliver 908 l of transferred water with one M18™ 5.0 Ah battery charge
- REDLINK™ intelligence can recognise when the tool stops moving water and automatically shuts itself off to avoid dry pumping

M18 BTP-0

Kit included	No batteries supplied, No charger supplied, No kitbox or bag supplied
Article Number	4933471494
EAN Code	4058546293932

M12 BSWP

M12™ HYDROPASS™ BRUSHED STICK WATER PUMP

M12

- HYDROPASS™ unique filter system, prevents blocking of the inlet and allows the user to pump water at all times, regardless of the debris encountered
- Pumps more than 2000 l/hour and up to 1000 l on 1x M12™ 6.0 Ah battery, perfect for emptying trenches, storm drains, outside meter boxes, rain barrels and various other applications

	M12 BSWP-0	M12 BSWP-601
Kit included	No batteries supplied, No charger supplied, No kitbox or bag supplied	1 x M12 B6 Battery pack, C12 C Charger, No kitbox or bag supplied
Article Number	4933479639	4933479640
EAN Code	4058546374334	4058546374341

M18 FVP5

M18 FUEL™ VACUUM PUMP 5 CFM

M18 FUEL



- Up to 90 minutes of run time in Manifold Mode and 60 minutes of run time in Default Mode on an M18™ HIGH OUTPUT™ 8.0 Ah battery
- Delivers corded performance
- Instant power allows to vacuum a system without generators or temporary power
- 1/2", 3/8" and 1/4" ports and an additional 3/16" adaptor enables to easily fit different hose sizes
- Check valve protects vacuum when pump is not running

	M18 FVP5-0	M18 FVP5-801
Standard equipment	500 ml oil bottle, 3/16" adaptor	500 ml oil bottle, 5/16" adaptor
Kit included	No batteries supplied, No charger supplied, No kitbox or bag supplied	1 x M18 FB8 Battery pack, M12-18 FC Charger, No kitbox or bag supplied
Article Number	4933492853	4933499248
EAN Code	4058546477240	4058546564124



M18 ONEBLPXPL

M18™ ONE-KEY™ FORCE LOGIC™ UPONOR™ Q&E HYDRAULIC PIPE EXPANDING TOOL

M18

FORCELOGIC™

ONE-KEY™
UNLOCKING THE DIGITAL JOBSITE.



- The ONE-KEY™ FORCE LOGIC™ hydraulic expander is the world's first cordless expander for UPONOR™ Q&E PE-Xa pipe sizes up to DN75
- Brushless POWERSTATE™ motor delivers outstanding run time and quick expansions
- Expands dimensions DN40, DN50, DN63 and DN75 of 6 and 10 bar pipes

	M18 ONEBLPXPL-502C
Kit included	2 x M18 B5 Battery packs, M12-18 C Charger, Kitbox
Article Number	4933464299
EAN Code	4058546222444

M18 FPXP

M18 FUEL™ UPONOR™ Q&E EXPANSION TOOL

M18 FUEL

ONE-KEY™
UNLOCKING THE DIGITAL JOBSITE.



- Auto-rotating heads from 9.9 mm to 50 mm provide the most accurate, one-handed expansions
- Most compact 50 mm battery powered pipe expander
- Compatible with all existing M12™ and M18™ expansion heads up to 50 mm
- Fast solution for 50 mm Q&E installations
- Two speed settings: one for up to 32 mm and one for 40 mm and above

	M18 FPXP-0C	M18 FPXP-H06502C	M18 FPXP-H10502C
Included heads	-	6 bar Heads 32/40/50 mm	10 bar Heads 32/40/50 mm
Kit included	No batteries supplied, No charger supplied, Kitbox	2 x M18 B5 Battery packs, M12-18 FC Charger, Kitbox	2 x M18 B5 Battery packs, M12-18 FC Charger, Kitbox
Article Number	4933479436	4933479438	4933479437
EAN Code	4058546372309	4058546372323	4058546372316

HD18 PXP

M18™ UPONOR™ Q&E EXPANSION TOOL

M18



- Auto rotating head 12 mm to 40 mm (6 bar) and to 32 mm (10 bar) provides accurate, one-handed expansion
- REDLINK™ overload protection electronics in tool and battery pack deliver best in class system durability
- Quick cam mechanism - single pull continuous action installs Q&E up to 4x faster
- Steel gears and integrated magnesium frame

	HD18 PXP-H06202C	HD18 PXP-H10202C
Included heads	16/20/25/32 mm	16/20/25/32 mm
Kit included	2 x M18 B2 Battery packs, M12-18 C Charger, Kitbox	2 x M18 B2 Battery packs, M12-18 C Charger, Kitbox
Article Number	4933441771	4933441774
EAN Code	4002395001835	4002395001842

M12 FPXP

M12 FUEL™ SUB COMPACT UPONOR™ Q&E EXPANSION TOOL

M12 FUEL



- Auto-rotating head 9.9 mm to 32 mm (6 bar) and to 25 mm (10 bar) provides accurate, one-handed expansion
- Quick cam mechanism - single pull, continuous action installs Q&E up to 7 seconds faster
- RAPID SEAL™ heads improve time to seal by 20% or more (depending on the ambient temperatures)
- Dual acting trigger allows expansions from any grip position

	M12 FPXP-0C	M12 FPXP-H10202C	M12 FPXP-I06202C
Included heads	-	10 Bar heads 16 / 20 / 25 mm	6 Bar heads 16 / 20 / 25 mm
Kit included	No batteries supplied, No charger supplied, Kitbox	2 x M12 B2 Battery packs, C12 C Charger, Kitbox	2 x M12 B2 Battery packs, C12 C Charger, Kitbox
Article Number	4933472018	4933472020	4933472021
EAN Code	4058546324148	4058546324162	4058546324179

C12 PXP

M12™ SUB COMPACT UPONOR™ Q&E EXPANSION TOOL

M12



- Auto-rotating head 12 mm to 32 mm (6 bar) and to 25 mm (10 bar) provides accurate, one-handed expansion
- REDLINK™ overload protection electronics in tool and battery pack deliver best in class system durability
- Quick cam mechanism - single pull, continuous action installs Q&E up to 4x faster
- Steel gears and integrated frame

	C12 PXP-I06202C	C12 PXP-H10202C	C12 PXP-N202C
Included heads	16/ 20/ 25 mm	16/ 20/ 25 mm	15/18/22 mm
Kit included	2 x M12 B2 Battery packs, C12 C Charger, Kitbox	2 x M12 B2 Battery packs, C12 C Charger, Kitbox	2 x M12 B2 Battery packs, C12 C Charger, Kitbox
Article Number	4933441715	4933441730	4933441740
EAN Code	4002395002016	4002395002047	4002395002061

SEE PAGE 137 OR SCAN TO VIEW THE FULL RANGE OF EXPANDER HEADS



DRAIN CLEANING AND INSPECTION

SCAN HERE FOR MORE INFORMATION



MXF LSDP MX FUEL™ LARGE SEWER DRUM MACHINE WITH POWERTREDZ™



- The MX FUEL™ large sewer drum machine with integrated POWERTREDZ™, requires one person only to move the sewer machine in and out of the service van, up and down building stairs
- World's first battery powered large drum machine that uses MILWAUKEE® 16 mm and 20 mm inner core spirals in drains from 75 mm up to 200 mm, with the power to clear roots up to 60 m down the line

MXF LSDP-301

Standard equipment	1 x 20 mm x 15.2 m inner core cable, 1 x 20 mm x 7.6 m inner core cable, 1 x 9 pc head attachment kit
Kit included	1 x MXF CP203 Battery pack, MXF C Charger, No kitbox or bag supplied
Article Number	4933471851
EAN Code	4058546297503

M18 FFSDC13 M18 FUEL™ FREE STANDING DRAIN CLEANER 13 MM



- World's first free standing drum machine on a 18V battery, with electronic footpedal and integrated drum brake that electronically slows drum super-fast for more control and safety
- M18 FUEL™ SWITCH PACK™ tool-free sectional drum connection system allows users to quickly interchange between cable sizes, 8 mm, 10 mm, 13 mm inner core and 16 mm open wind spirals, or add a second drum to reach 30 m down the line

M18 FFSDC13-0

Standard equipment	1 x backpack assembly, 2 x drum assembly's, 2 x 13 mm x 15 m cables, 1 x cutter set & removal tool
Kit included	No batteries supplied, No charger supplied, No kitbox or bag supplied
Article Number	4933459708
EAN Code	4058546028800

M18 FFSDC10 M18 FUEL™ FREE STANDING DRAIN CLEANER 10 MM



- World's first free standing drum machine on a 18V battery, with electronic footpedal and integrated drum brake that electronically slows drum super-fast for more control and safety
- M18 FUEL™ SWITCH PACK™ tool-free sectional drum connection system allows users to quickly interchange between cable sizes, 8 mm, 10 mm, 13 mm inner core and 16 mm open wind spirals, or add a second drum to reach 30 m down the line

M18 FFSDC10-0

Standard equipment	1 x backpack assembly, 1 x drum assembly, 1 x 10 mm x 15 m cables, 1 x cutter set & removal tool
Kit included	No batteries supplied, No charger supplied, No kitbox or bag supplied
Article Number	4933459707
EAN Code	4058546028794

M18 FDCPF10 M18 FUEL™ DRAIN CLEANER - POWER FEED 10 MM



- World's first hand held drain cleaner on a 18V battery with automatic feed and retract that can be used with 6 mm, 8 mm and 10 mm spirals from both MILWAUKEE® and other manufacturers, in pipes from 32 mm up to 75 mm, up to 15 m down the line, eliminating all electrocution hazards users encounter today with their corded tools

M18 FDCPF10-0C

M18 FDCPF10-201C

Standard equipment	1 x 10 mm x 10.6 m cable (48532675), retriever bulb, removal pin	1 x 10 mm x 10.6 m cable (48532675), 5 pc cutter set (48532685), removal pin
Kit included	No batteries supplied, No charger supplied, Closed bucket	1 x M18 B2 Battery pack, M12-18 FC Charger, Closed bucket
Article Number	4933459684	4933459685
EAN Code	4058546028565	4058546028572

M18 FFSDC16 M18 FUEL™ FREE STANDING DRAIN CLEANER 16 MM



- World's first free standing drum machine on a 18V battery, with electronic footpedal and integrated drum brake that electronically slows drum super-fast for more control and safety
- M18 FUEL™ SWITCH PACK™ tool-free sectional drum connection system allows users to quickly interchange between cable sizes, 8 mm, 10 mm, 13 mm inner core and 16 mm open wind spirals, or add a second drum to reach 30 m down the line

M18 FFSDC16-0

M18 FFSDC16-502

Standard equipment	1 x backpack assembly, 2 x drum assembly's, 2 x 16 mm x 15 m cables, 1 x cutter set & removal tool	1 x backpack assembly, 2 x drum assembly's, 2 x 16 mm x 15 m cables, 1 x cutter set & removal tool
Kit included	No batteries supplied, No charger supplied, No kitbox or bag supplied	2 x M18 B5 Battery packs, M12-18 FC Charger, No kitbox or bag supplied
Article Number	4933459709	4933459710
EAN Code	4058546028817	4058546028824

SCAN TO VIEW THE AUTO FEED SYSTEM ATTACHMENTS



M18 FDCPF8 **M18 FUEL**
M18 FUEL™ DRAIN CLEANER - POWER FEED 8 MM



- World's first hand held drain cleaner on a 18V battery with automatic feed and retract that can be used with 6 mm, 8 mm and 10 mm spirals from both MILWAUKEE® and other manufacturers, in pipes from 32 mm up to 75 mm, up to 15 m down the line, eliminating all electrocution hazards users encounter today with their corded tools

M18 FDCPF8-0C

Standard equipment	8 mm x 10.6 m cable (48532673)
Kit included	No batteries supplied, No charger supplied, Closed bucket
Article Number	4933459683
EAN Code	4058546028558

M12 BDC8 **M12**
M12™ SUB COMPACT DRAIN CLEANER WITH SPIRAL DIAMETER 8 MM



- Lightest professional drain cleaner on the market
- Versatile design, provides benefits of both handheld and floor based drain cleaners in one machine
- Best user flexibility and manoeuvrability due to the independence of electric power supply

M12 BDC8-0C

M12 BDC8-202C

Standard equipment	8 mm x 7.6 m inner core bulb head	8 mm x 7.6 m inner core bulb head
Kit included	No batteries supplied, No charger supplied, Bucket	2 x M12 B2 Battery packs, C12 C Charger, Bucket
Article Number	4933451632	4933451633
EAN Code	4002395140992	4002395141609

M12 BDC6 **M12**
M12™ SUB COMPACT DRAIN CLEANER WITH SPIRAL DIAMETER 6 MM



- Lightest professional drain cleaner on the market
- Versatile design, provides benefits of both handheld and floor based drain cleaners in one machine
- Best user flexibility and manoeuvrability due to the independence of electric power supply

M12 BDC6-0C

M12 BDC6-202C

Standard equipment	6 mm x 7.6 m inner core bulb head	6 mm x 7.6 m inner core bulb head
Kit included	No batteries supplied, No charger supplied, Bucket	2 x M12 B2 Battery packs, C12 C Charger, Bucket
Article Number	4933451634	4933451635
EAN Code	4002395141616	4002395141623

SEE PAGE 110 OR SCAN TO VIEW OUR SYSTEM ATTACHMENTS FOR DRAIN CLEANERS



M18 FCSSM **M18 FUEL**
M18 FUEL™ COMPACT SECTIONAL SEWER MACHINE



- World's first compact sectional sewer machine on a 18V battery that uses 16 mm and 22 mm sectional spirals from both MILWAUKEE® and other manufacturers, eliminating all electrocution hazards users encounter today with their corded tools
- Extremely light weight, 14 kg including M18™ 12.0 Ah battery, allowing user to comfortably transport the compact sectional up multiple flights of stairs or over longer distances

M18 FCSSM-0

M18 FCSSM-121

Kit included	No batteries supplied, No charger supplied, No kitbox or bag supplied	1 x M18 FB12 Battery pack, M12-18 FC Charger, No kitbox or bag supplied
Article Number	4933478408	4933499308
EAN Code	4058546345990	4058546564728

SEE PAGE 111 OR SCAN TO VIEW OUR SYSTEM ATTACHMENTS FOR SECTIONAL SEWER MACHINE



M18 HSFSM **M18 FUEL**
M18™ HIGH SPEED FLEXIBLE SHAFT MACHINE



- Clears clogs in 32 mm (1 1/4") – 110 mm (4") pipes up to 23 m down the line
- Infinite variable speed from 600 – 2200 RPM for more control in the line and best wall to wall clean
- Integrated mechanical clutch protecting the cable when binding up
- Nylon coated 8 mm cable with universal reception to fit and use with most common attachment heads available on the market

M18 HSFSM-0

M18 HSFSM-122

Kit included	No batteries supplied, No charger supplied, No kitbox or bag supplied	2 x M18 FB12 Battery packs, M12-18 FC Charger, No kitbox or bag supplied
Article Number	4933480721	4933499309
EAN Code	4058546410063	4058546564735



DRAIN CLEANING AND INSPECTION

STEP 1 CHOOSE YOUR DESIRED REEL

M18 SIC60SC HDR

M18

M18™ SEWER INSPECTION CAMERA REEL 60 M, 25 MM CAMERA HEAD



- The modular MILWAUKEE® camera system allows the user to pick the camera reel that suits the most their specific needs on the jobsite
- The new 25 mm HDR (High Dynamic Range) camera guarantees better images in low light conditions
- 60 m long, 10 mm mid stiff push rod for easier reach of longer runs but still flexible enough to run through 50 mm 90 degree bends
- Fully enclosed reels for better mess containment
- Rubber stand for putting reel on back
- Extendable handle for easier transportation

M18 SIC60SC HDR-0

Article Number	4933493955
EAN Code	4058546511159

M18 SIC60 HDR

M18

M18™ SEWER INSPECTION CAMERA REEL 60 M, 60 MM CAMERA HEAD



- The modular MILWAUKEE® camera system allows the user to pick the camera reel that suits the most their specific needs on the jobsite
- The new 34 mm HDR (High Dynamic Range) camera guarantees better images in low light conditions
- 60 m long, 12 mm stiff push rod for easier reach of longer runs but still flexible enough to run through 75 mm 90 degree bends
- Fully enclosed reels for better mess containment
- Built-in sonde for easy locating: 512 Hz, 640 Hz, 33 kHz to be used with all common locators

M18 SIC60 HDR-0

Article Number	4933493954
EAN Code	4058546511142

M18 SIC36 HDR

M18

M18™ SEWER INSPECTION CAMERA REEL 36 M, 25 MM HDR CAMERA HEAD



- The modular MILWAUKEE® camera system allows the user to pick the camera reel that suits the most their specific needs on the jobsite
- The new 25 mm HDR (High Dynamic Range) camera guarantees better images in low light conditions
- 36 m long, 9.5 mm mid stiff push rod for easier reach of longer runs but still flexible enough to run through 50 mm 90 degree bends
- Built-in sonde for easy locating: 512 Hz, 640 Hz, 33 kHz to be used with all common locators
- Built-in line trace for locating the push rod
- Back pack straps for easier transportation

M18 SIC36 HDR-0

Article Number	4933493953
EAN Code	4058546511135

M18 SIC30 HDR

M18

M18™ SEWER INSPECTION CAMERA REEL 30 M, 25 MM HDR CAMERA HEAD



- The modular MILWAUKEE® camera system allows the user to pick the camera reel that suits the most their specific needs on the jobsite
- The new 25 mm HDR (High Dynamic Range) camera guarantees better images in low light conditions
- Pitch sensing camera heads provide pipe pitch reading on-screen indicator
- Built-in sonde for easy locating: 512 Hz, 640 Hz, 33 kHz to be used with all common locators
- Built-in line trace for locating the push rod
- Fully enclosed reels for better mess containment

M18 SIC30 HDR-0

Article Number	4933493952
EAN Code	4058546511128

M12 SICO20

M12

M12™ SEWER INSPECTION CAMERA 20 M WITH ONE-KEY™

ONE-KEY™
UNLOCKING THE DIGITAL JOBSITE.



- The modular MILWAUKEE® camera system allows the user to pick the camera reel that suits the most their specific needs on the job site
- The new 16 mm HD camera guarantees the highest maneuverability in small pipe diameters with best-in-class images
- 20 m long, 7.5 mm ultra flexible push rod to run through several 32 mm 90° bends
- Integrated Smart-Hub With a USBport for data storage
- Wi-Fi functionality enables the sewer inspection camera to transfer data via USB-A, USB-C and over the air

M12 SICO20-0

Kit included	No batteries supplied, No charger supplied, No kitbox or bag supplied
Article Number	4933498231
EAN Code	4058546521004

M12 SICO26

M12

M12™ SEWER INSPECTION CAMERA 26 M WITH ONE-KEY™

ONE-KEY™
UNLOCKING THE DIGITAL JOBSITE.



- The modular MILWAUKEE® camera system allows the user to pick the camera reel that suits the most their specific needs on the job site
- The new 20mmself-leveling HD camera centers itself automatically and guarantees top-class images
- 26 m long, 9.5 mm high flexible push rod to run through several 40 mm 90° bends
- Integrated Smart-Hub with a USBport for data storage
- Wi-Fi functionality enables the sewer inspection camera to transfer data via USB-A, USB-C and over the air

M12 SICO26-0

Kit included	No batteries supplied, No charger supplied, No kitbox or bag supplied
Article Number	4933498230
EAN Code	4058546520991

**SCAN HERE FOR
MORE INFORMATION**



STEP 2 SMART HUB (FOR M18™ REELS ONLY)

M18 SISH M18™ SEWER INSPECTION SMART HUB

M18

ONE-KEY
UNLOCKING THE DIGITAL JOBSITE.



- Easily interchangeable between reels with one push on the button
- Integrated WI-FI for connection with MILWAUKEE® monitor and tablet or smartphone with NEW MILWAUKEE® App
- Share customised reports
- Multiple screen viewing and recording
- ONE-KEY™ tool tracking & security offers a free of charge cloud-based tracking network and inventory management platform for your tools. ONE-KEY™ also features a remote locking functionality
- 500 GB SSD-drive store multiple jobs and extract when needed
- USB 3.0 and USB-C ports

M18 SISH-0

Kit included	No batteries supplied, No charger supplied, No kitbox or bag supplied
Article Number	4933471415
EAN Code	4058546290436



STEP 3 CHOOSE YOUR VIEWING DEVICE

M18 SIM M18™ SEWER INSPECTION MONITOR

M18

ONE-KEY
UNLOCKING THE DIGITAL JOBSITE.



- Wireless 8" high resolution, 800 x 600, LCD screen for optimal viewing
- Sun readable screen for best viewing of inspection
- ONE-KEY™ tool tracking & security offers a free of charge cloud-based tracking network and inventory management platform for your tools. ONE-KEY™ also features a remote locking functionality

M18 SIM-0

Kit included	No batteries supplied, No charger supplied, No kitbox or bag supplied
Article Number	4933471414
EAN Code	4058546290429

M12 SIM M12™ SEWER INSPECTION MONITOR

M12



- The M12™ SIM can be connected to the M12™ and M18™ reels via Wifi or used as an endoscope camera with the camera cable Attachments
- Possibility to transfer files via USB-A, USB-C, microSD card and conveniently over the air
- The 5.5" LCD touchscreen provides sharp and clear images and allows the user to see detailed areas

M12 SIM-0

Kit included	No batteries supplied, No charger supplied, No kitbox or bag supplied
Article Number	4933493592
EAN Code	4058546484637



**M12™ & M18™
SYSTEMS ARE
COMPATIBLE WITH
EACH OTHER**

M12™ & M18™ reels both work with M12™ & M18™ monitors or the MILWAUKEE® Pipeline Inspection App

**VIEW ON YOUR
PHONE WITH THE**



STEP 4 SAVE YOUR RECORDINGS



OR



M12 PL M12™ PLUMBING LOCATOR

M12

ONE KEY
UNLOCKING THE DIGITAL JOBSITE



- Easy to use plumbing locator: 2 omni directional antennas make locating sondes and tracing energised lines easy without any ghost signals
- First locator on the market on a 12V battery with 13 hours run time on a M12™ 2.0 Ah battery, no alkaline batteries that need frequent changing
- 4.3" colour LCD screen with backlit buttons for better visibility

M12 PL-0C

M12 PL-201C

Kit included	No batteries supplied, No charger supplied, Kitbox	1 x M12 B2 Battery pack, C12 C Charger, Kitbox
Article Number	4933471995	4933478615
EAN Code	4058546298944	4058546348083



M12 360IC12 M12™ 360° INSPECTION CAMERA 1.2 M 2ND GEN

M12



- 4.3" LCD screen delivers sharp and clear images and allows users to see objects in greater detail
- 270° rotating screen provides the user fluid image control in every position of use
- 1.2 metre cable balances flexibility and rigidity for both drain line and behind wall inspections
- Included 32 GB micro SD card allows to record and store images and videos

M12 360IC12-0C

M12 360IC12-201C

Standard equipment	4x Accessories	4x Accessories
Kit included	No batteries supplied, No charger supplied, Kitbox	1 x M12 B2 Battery pack, C12 C Charger, Kitbox
Article Number	4933480739	4933480740
EAN Code	4058546410247	4058546410254



M12 360IC32 M12™ 360° INSPECTION CAMERA 3 M 2ND GEN

M12



- 4.3" LCD screen delivers sharp and clear images and allows users to see objects in greater detail
- 270° rotating screen provides the user fluid image control in every position of use
- 3 metre cable balances flexibility and rigidity for both drain line and behind wall inspections
- Included 32 GB micro SD card allows to record and store images and videos

M12 360IC32-0C

Standard equipment	4x Accessories
Kit included	No batteries supplied, No charger supplied, Kitbox
Article Number	4933480741
EAN Code	4058546410261

AIC2 ALKALINE INSPECTION CAMERA 2ND GEN

M12



- 4.3" LCD screen delivers sharp and clear images and allows users to see objects in greater detail
- 1.2 metre cable balances flexibility and rigidity for both drain line and behind wall inspections
- 5 modes of brightness provide best in class illumination without shadow or glare
- 720p camera resolution provides outstanding image quality

AIC2

Standard equipment	4x Accessories
Kit included	4 x AA Batteries, Kitbox
Article Number	4933480738
EAN Code	4058546410230



**SEE PAGE
140 OR SCAN
TO VIEW OUR
SYSTEM
ATTACHMENTS
FOR
INSPECTION
CAMERAS**



OPE

SCAN HERE FOR MORE INFORMATION



M18 F2LM46

M18 FUEL

M18 FUEL™ DUAL BATTERY SELF-PROPELLED LAWN MOWER 46 CM



- 46 cm steel deck and blade design paired with M18 FUEL™ technology deliver best-in-class quality of cut
- Compact deck design for more maneuverability in tight access areas
- 3-in-1 grass management system to mulch, bag, or rear side discharge

	M18 F2LM46-0	M18 F2LM46-802
Kit included	No batteries supplied, No charger supplied, No kitbox or bag supplied	2 x M18 FB8 Battery packs, M18 DBSC Charger, No kitbox or bag supplied
Article Number	4933492010	4933499215
EAN Code	4058546413774	4058546563790

M18 F2LM53

M18 FUEL

M18 FUEL™ DUAL BATTERY SELF-PROPELLED LAWN MOWER 53 CM



- 53 cm steel deck and blade design paired with M18 FUEL™ technology deliver best-in-class quality of cut
- Instant start in tall grass, outstanding peak power and start up torque to complete demanding applications
- 3-in-1 grass management system to mulch, bag, or rear side discharge
- Automatic blade speed adjustment to the required power for more efficiency

	M18 F2LM53-0	M18 F2LM53-122
Kit included	No batteries supplied, No charger supplied, No kitbox or bag supplied	2 x M18 FB12 Battery packs, M18 DBSC Charger, No kitbox or bag supplied
Article Number	4933479584	4933499213
EAN Code	4058546373788	4058546563776

M18 BLLT

M18

M18™ BRUSHLESS GRASS TRIMMER

BRUSHLESS



- The M18™ brushless grass trimmer has the power to clear thick brush and reaches full throttle in under 1 second
- Up to 4600 RPM in first mode and 6200 RPM in second mode
- 2-speed variable trigger allows the user to choose between higher performance or extended run time
- Adjustable cutting swath of 35 cm – 40 cm

	M18 BLLT-0
Kit included	No batteries supplied, No charger supplied, No kitbox or bag supplied
Article Number	4933472218
EAN Code	4058546326142

M18 FBCU

M18 FUEL

M18 FUEL™ BRUSH CUTTER



- Powerful brush cutter designed to clear grass, weeds, thick brush and saplings up to 3 cm diameter
- Full throttle in under 1 second for instantaneous power and ultimate control
- Supplied with a trimmer head for a 35 - 40 cm cutting swath and a 23 cm blade featuring a 4-tooth design to take on more demanding applications

	M18 FBCU-0	M18 FBCU-802
Kit included	No batteries supplied, No charger supplied, No kitbox or bag supplied	2 x M18 FB8 Battery packs, M12-18 FC Charger, No kitbox or bag supplied
Article Number	4933492297	4933499211
EAN Code	4058546416645	4058546563752

M18 F2BCU

M18 FUEL

M18 FUEL™ DUAL BATTERY BRUSH CUTTER

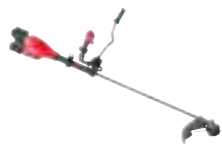

- Powerful and robust brush cutter designed to clear high and dense grass, weeds and thick brush
- M18 FUEL™ Technology allows the tool to maintain speed in the most demanding applications without bogging down
- Instantaneous throttle response for ultimate control and increased productivity

	M18 F2BCU-0	M18 F2BCU-122
Kit included	No batteries supplied, No charger supplied, No kitbox or bag supplied	2 x M18 FB12 Battery packs, M18 DBSC Charger, No kitbox or bag supplied
Article Number	4933480859	4933480860
EAN Code	4058546411442	4058546411459

SEE PAGES 130 - 131 OR SCAN TO VIEW OUR OUTDOOR POWER EQUIPMENT ACCESSORIES RANGE



M18 FEDG M18 FUEL™ EDGER

M18 FUEL



- Delivers the power and torque to tackle demanding applications
- 20 cm blade and easy adjustable wheel allowing the user to select the appropriate height for the application
- Professional open guard design to avoid clogging, with sight line included for easy blade location
- Debris flap protects the user from dirt, rocks and grass

M18 FEDG-0

Kit included	No batteries supplied, No charger supplied, No kitbox or bag supplied
Article Number	4933493556
EAN Code	4058546484279

M18 FHET75G2 M18 FUEL™ HEDGE TRIMMER 75 CM

M18 FUEL



- 75 cm double sharpened & dual actuating blades for clean cuts and removal of thicker material
- 32 mm blade gap with the power to cut up to 25 mm hardwood branches
- 5-position rotating handle provides increased control in different blade orientations
- Clipping sweep kitted with the tool allowing to remove clippings during the application

M18 FHET75G2-0

M18 FHET75G2-802

Kit included	No batteries supplied, No charger supplied, No kitbox or bag supplied	2 x M18 FB8 Battery packs, M12-18 FC Charger, No kitbox or bag supplied
Article Number	4933498387	4933498388
EAN Code	4058546522568	4058546522575

M18 FHET60G2 M18 FUEL™ HEDGE TRIMMER 60 CM

M18 FUEL



- 60 cm double sharpened & dual actuating blades for clean cuts and removal of thicker material
- 32 mm blade gap with the power to cut up to 25 mm hardwood branches
- 5-position rotating handle provides increased control in different blade orientations
- Clipping sweep kitted with the tool allowing to remove clippings during the application

M18 FHET60G2-0

M18 FHET60G2-802

Kit included	No batteries supplied, No charger supplied, No kitbox or bag supplied	2 x M18 FB8 Battery packs, M12-18 FC Charger, No kitbox or bag supplied
Article Number	4933498384	4933498385
EAN Code	4058546522537	4058546522544

M18 FHETE27 M18 FUEL™ EXTENDED POLE HEDGE TRIMMER 267 CM

M18 FUEL



- Overall tool length of 267 cm allowing for long extended reach applications
- 60 cm double sharpened & dual actuating blades for clean cuts
- 25 mm blade gap with the power to cut up to 22 mm branches
- 13 operating positions offer a 270-degree rotating blade set providing increased access in hard-to-reach areas

M18 FHETE27-0

M18 FHETE27-802

Kit included	No batteries supplied, No charger supplied, No kitbox or bag supplied	2 x M18 FB8 Battery packs, M12-18 FC, No kitbox or bag supplied
Article Number	4933492910	4933492911
EAN Code	4058546477813	4058546477820

M18 FHETE22 M18 FUEL™ EXTENDED POLE HEDGE TRIMMER 216 CM

M18 FUEL



- Overall tool length of 216 cm allowing for maneuverable overhead applications
- 60 cm double sharpened & dual actuating blades for clean cuts
- 25 mm blade gap with the power to cut up to 22 mm branches
- 13 operating positions offer a 270-degree rotating blade set providing increased access in hard-to-reach areas

M18 FHETE22-0

M18 FHETE22-802

Kit included	No batteries supplied, No charger supplied, No kitbox or bag supplied	2 x M18 FB8 Battery packs, M12-18 FC Charger, No kitbox or bag supplied
Article Number	4933498515	4933498516
EAN Code	4058546523848	4058546523855

M12 FHT20 M12 FUEL™ HEDGE TRIMMER 20 CM

M12 FUEL



- 20 cm blade ideal for small detail work like trimming overgrowth or topiary of hedges, shrubs and small bushes
- Delivers fast and precise cuts for utmost productivity
- All metal gear case for increased durability
- Slim ergonomic gripping area for outstanding control in tight to reach areas
- Well balanced and low weight for better control and effortless cutting in multiple positions

M12 FHT20-0

M12 FHT20-402

Kit included	No batteries supplied, No charger supplied, No kitbox or bag supplied	2 x M12 B4 Battery packs, C12 C Charger, No kitbox or bag supplied
Article Number	4933479675	4933479676
EAN Code	4058546374693	4058546374709

M18 FCHS M18 FUEL™ CHAINSAW WITH 40 CM BAR

M18 FUEL



- The M18 FUEL™ chainsaw delivers the power to outperform on the most demanding chainsaw applications vs. petrol chainsaws
- FUEL™ technology allows the saw to maintain speed in tough application without bogging down, giving it the ability to outperform petrol chainsaws up to 40cc

M18 FCHS-0

M18 FCHS-122

Kit included	No batteries supplied, No charger supplied, No kitbox or bag supplied	2 x M18 FB12 Battery packs, M12-18 FC Charger, No kitbox or bag supplied
Article Number	4933464723	4933499217
EAN Code	4058546226688	4058546563813

M18 FCHS35 M18 FUEL™ CHAINSAW WITH 35 CM BAR

M18 FUEL



- Delivers the power to outperform on the most demanding applications vs. petrol chainsaws
- Maintains speed in tough applications without bogging down
- The HIGH OUTPUT™ system of tools elevates the M18 FUEL™ technologies to a new level and delivers extended performance and extended run time. These tools are designed to maximise the partnership with HIGH OUTPUT™ and FORGE™ batteries

M18 FCHS35-0

M18 FCHS35-122

Kit included	No batteries supplied, No charger supplied, No kitbox or bag supplied	2 x M18 FB12 Battery packs, M12-18 FC Charger, No kitbox or bag supplied
Article Number	4933479678	4933499223
EAN Code	4058546374723	4058546563875

M18 FCHSC 
M18 FUEL™ CHAINSAW WITH 30 CM BAR



- Delivers the power to outperform on the most demanding chainsaw applications vs. petrol chainsaws
- FUEL™ technology allows the saw to maintain speed in tough application without bogging down, giving it the ability to outperform petrol chainsaws up to 40cc

	M18 FCHSC-0	M18 FCHSC-122
Kit included	No batteries supplied, No charger supplied, No kitbox or bag supplied	2 x M18 FB12 Battery packs, M12-18 FC Charger, No kitbox or bag supplied
Article Number	4933471441	4933499219
EAN Code	4058546290696	4058546563837

M18 F2CHS50 
M18 FUEL™ DUAL BATTERY CHAINSAW 50 CM



- Outstanding speed of cut in hardwood compared to 60 cc petrol chainsaws
- Peak torque levels of 9.5 Nm maintains the chain speed through tough application and prevents bog downs
- 50 cm cutting system and a peak power of 5.8 HP to tackle felling and bucking applications
- High visibility felling sights to ensure precision and accuracy

	M18 F2CHS50-0	M18 F2CHS50-802
Kit included	No batteries supplied, No charger supplied, No kitbox or bag supplied	2 x M18 FB8 Battery packs, M18 DFC Charger, No kitbox or bag supplied
Article Number	4933480120	4933480121
EAN Code	4058546404055	4058546404062

M18 FTHCHS35 
M18 FUEL™ TOP HANDLE CHAINSAW WITH 35 CM BAR



- Outstanding speed of cut in hardwood vs petrol or higher voltage top handle chainsaws
- High torque to complete cuts in demanding materials and maintains speed under heavy loads without bogging down
- FUEL™ technology to reach full throttle in under 1 second
- Up to 150 cuts in 10 x 10 cm cedar on a full M18™ HIGH OUTPUT™ 8.0 Ah battery charge for outstanding productivity

	M18 FTHCHS35-0	M18 FTHCHS35-802
Kit included	No batteries supplied, No charger supplied, No kitbox or bag supplied	2 x M18 FB8 Battery packs, M12-18 FC Charger, No kitbox or bag supplied
Article Number	4933479588	4933499222
EAN Code	4058546373825	4058546563868

M18 FTHCHS30 
M18 FUEL™ TOP HANDLE CHAINSAW WITH 30 CM BAR



- Outstanding speed of cut in hardwood vs petrol or higher voltage top handle chainsaws
- High torque to complete cuts in demanding materials and maintains speed under heavy loads without bogging down
- FUEL™ technology to reach full throttle in under 1 second
- Up to 150 cuts in 10 x 10 cm cedar on a full M18™ HIGH OUTPUT™ 8.0 Ah battery charge for outstanding productivity

	M18 FTHCHS30-0	M18 FTHCHS30-802
Kit included	No batteries supplied, No charger supplied, No kitbox or bag supplied	2 x M18 FB8 Battery packs, M12-18 FC Charger, No kitbox or bag supplied
Article Number	4933479586	4933499221
EAN Code	4058546373801	4058546563851

M18 FHS20 
M18 FUEL™ HATCHET™ PRUNING SAW 20 CM



- M18 FUEL™ HATCHET™ pruning saw delivers outstanding power and torque to cut hardwood without bogging down
- Designed to meet the ergonomic, performance, and durability needs of landscape maintenance professionals
- Compact design for increased control and maneuverability in tight access areas

	M18 FHS20-0	M18 FHS20-552
Kit included	No batteries supplied, No charger supplied, No kitbox or bag supplied	2 x M18 HB5.5 Battery packs, M12-18 FC Charger, No kitbox or bag supplied
Article Number	4933480117	4933480118
EAN Code	4058546404024	4058546404031

M12 FHS 
M12 FUEL™ HATCHET™ PRUNING SAW 15 CM



- M12 FUEL™ HATCHET™ pruning saw delivers outstanding control & access, has the power to cut 75 mm hardwoods, and delivers up to 120 cuts per charge on an M12 B4 battery pack
- Designed to meet the ergonomic, performance, and durability needs of landscape maintenance professionals

	M12 FHS-0	M12 FHS-602X
Kit included	No batteries supplied, No charger supplied, No kitbox or bag supplied	2 x M12 B6 Battery packs, C12 C Charger, HD Box
Article Number	4933472211	4933472212
EAN Code	4058546326074	4058546326081

M12 BLPRS 
M12™ BRUSHLESS PRUNING SHEARS

BRUSHLESS



- Power to cut branches up to 32 mm
- Trigger tracking technology allowing for blade movement to follow the trigger movement for increased control during the application
- No manual effort required, especially convenient for extended applications
- Mode select board provides ability to lock blades into half capacity of 16 mm, allowing for increased cut speed

	M12 BLPRS-0	M12 BLPRS-202
Kit included	No batteries supplied, No charger supplied, No kitbox or bag supplied	2 x M12 B2 Battery packs, C12 C Charger, No kitbox or bag supplied
Article Number	4933480114	4933480115
EAN Code	4058546403997	4058546404000

M18 FBLG3 
M18 FUEL™ BLOWER



- Up to 14.2 m³/min of air volume at 193 km/h to clear debris
- Consistent blowing force of 12.2 N throughout the entire battery discharge
- Reaches full throttle in under 1 second
- Ambidextrous variable speed lock allowing the user to lock on to any speed for precise applications and optimum run time

	M18 FBLG3-0	M18 FBLG3-802
Kit included	No batteries supplied, No charger supplied, No kitbox or bag supplied	2 x M18 FB8 Battery packs, M12-18 FC Charger, No kitbox or bag supplied
Article Number	4933493301	4933499233
EAN Code	4058546481728	4058546563974

M18 F2BPB **M18 FUEL™** DUAL BATTERY BACKPACK BLOWER



- High constant clearing force with a consistent blowing force of 20.5 N over the entire battery discharge
- 2 x 18V dedicated backpack blower with a padded back pad and padded adjustable straps for extreme comfort
- Up to four battery slots for extended run time
- Up to 18.5 m³/min of air volume at 250 km/h to clear leaves, gravel and debris

	M18 F2BPB-0	M18 F2BPB-124
Kit included	No batteries supplied, No charger supplied, No kitbox or bag supplied	4 x M18 FB12 Battery packs, M18 MPC6 Charger, No kitbox or bag supplied
Article Number	4933493212	4933499231
EAN Code	4058546480837	4058546563950

M18 F2BL **M18 FUEL™** DUAL BATTERY BLOWER



- Up to 17 m³/min of air volume at 233 km/h to clear leaves, gravel and debris
- High constant clearing force with a consistent blowing force of 17.7 N over the entire battery discharge
- Best clearing control due to balanced design and ambidextrous variable speed lock allowing the user to lock on to any speed for precise applications

	M18 F2BL-0	M18 F2BL-802
Kit included	No batteries supplied, No charger supplied, No kitbox or bag supplied	2 x M18 FB8 Battery packs, M18 DBSC Charger, No kitbox or bag supplied
Article Number	4933479987	4933499229
EAN Code	4058546377816	4058546563936

M18 FTSP30 **M18 FUEL™** TELESCOPIC POLE SAW 30 CM



- Powerful cutting performance due to a chain speed of 25.4 m/s, high torque and 30 cm cutting length for fast results
- Outperforms petrol pole saws in demanding applications
- Features a telescopic shaft with a square profile and a quick length adjustment collar, allowing for optimal length adjustment of up to 400 cm

	M18 FTSP30-0	M18 FTSP30-121
Kit included	No batteries supplied, No charger supplied, No kitbox or bag supplied	1 x M18 FB12 Battery pack, M12-18 FC Charger, No kitbox or bag supplied
Article Number	4933480868	4933499227
EAN Code	4058546411534	4058546563912

M18 BLTS **M18™** BRUSHLESS TELESCOPIC SHEAR

BRUSHLESS



- Power to cut up to 4.4 cm softwood branches
- Telescopic function with an easy-to-use collar allows to expand from 2.1 up to 3 metres for versatile applications
- Up to 2000 cuts in 2.5 cm softwood branches with an M18 HB5.5 HIGH OUTPUT™ battery pack
- Outer shaft jacket for increased control & optimum grip

	M18 BLTS-0	M18 BLTS-551
Kit included	No batteries supplied, No charger supplied, No kitbox or bag supplied	1 x M18 HB5.5 Battery pack, M12-18 FC Charger, No kitbox or bag supplied
Article Number	4933480865	4933490866
EAN Code	4058546411503	4058546411510

M12 BHCS3L **M12™** HANDHELD CHEMICAL SPRAYER 3.7 L



- Instant, constant and adjustable pressure for best in class control
- Three pressure settings deliver the capability to optimise performance for a wide range of applications like spot, broadcast and distance spraying
- No manual pumping allows faster application speed and reduces user fatigue versus other manual sprayers

	M12 BHCS3L-0	M12 BHCS3L-201
Kit included	No batteries supplied, No charger supplied, No kitbox or bag supplied	1 x M12 B2 Battery pack, C12 C Charger, No kitbox or bag supplied
Article Number	4933480781	4933480782
EAN Code	4058546410667	4058546410674

M18 BBPFP2 **M18™** BACK PACK FLUID PUMP GEN2



- New design for improved user comfort and durability
- The interchangeable tank design isolates the pump, hose and wand, separating wearable components from the M18™ SWITCH TANK™ powered base
- Add on and replace tank assemblies to eliminate cross-chemical contamination and lower cost of ownership

	M18 BBPFP2-0	M18 BBPFP2-301
Kit included	No batteries supplied, No charger supplied, No kitbox or bag supplied	1 x M18 HB3 Battery pack, M12-18 FC Charger, No kitbox or bag supplied
Article Number	4933498961	4933498962
EAN Code	4058546528300	4058546528317

M18 BBPFP2-WST **M18™** SWITCH TANK™ 15L WATER SUPPLY



- Fully compatible with SWITCH TANK™ G2
- Water sprayer tank for efficient water delivery for concrete cutting and coring applications. Also useful for washing up slurry's, areas and equipment
- Semi-transparent tank with measuring scale to know how much liquid is inside the tank
- Carry handle lid with wide mouth makes easy transport and pouring of water into tank

	M18 BBPFP2-WST
Article Number	4933498965
EAN Code	4058546528348

M18 BBPFP2-CST **M18™** SWITCH TANK™ 15L CHEMICAL SPRAYER



- Fully compatible with SWITCH TANK™ G2
- Up to 7.4 m vertical spray distance and adjustable spray pattern - from cone to straight stream for end user preference and application.
- Chemical sprayer tank for pesticides/fertilizers/treatments/herbicides/fungicides/insecticides/de-icing agents and more
- Semi-transparent tank with measuring scale to know how much liquid is inside the tank

	M18 BBPFP2-CST
Article Number	4933498964
EAN Code	4058546528331

M18 FOPH2 **M18 FUEL™ OUTDOOR POWER HEAD WITH QUIK-LOK™**



- 30% increase in power and thermal performance: unlocks unmatched capabilities for superior performance
- 3-speed settings with variable speed trigger best suited for numerous applications
- Versatile outdoor power equipment system, powered by a single power head
- Delivers the capability to swap between multiple attachments to complete a wide range of applications

M18 FOPH2-0

M18 FOPH2-802

Kit included	No batteries supplied, No charger supplied, No kitbox or bag supplied	2 x M18 FB8 Battery packs, M12-18 FC, No kitbox or bag supplied
Article Number	4933492662	4933492664
EAN Code	4058546414122	4058546414146

M18 FOPHLTKIT2 **M18 FUEL™ OUTDOOR POWER HEAD - GRASS TRIMMER KIT**



- 30% increase in power and thermal performance: unlocks unmatched capabilities for superior performance
- 3-speed settings with variable speed trigger best suited for numerous applications
- Versatile outdoor power equipment system, powered by a single power head
- Delivers the capability to swap between multiple attachments to complete a wide range of applications

M18 FOPHLTKIT2-0

Kit included	No batteries supplied, No charger supplied, No kitbox or bag supplied
Article Number	4933492663
EAN Code	4058546414139

M18 FOPH2 ATTACHMENTS



	Name	Description	Article Number	EAN Code
1.	M18 FOPH-LTA	QUIK-LOK™ grass trimmer attachment	4932464955	4058546229009
2.	M18 FOPH-HTA	QUIK-LOK™ hedge trimmer attachment	4932464959	4058546229047
3.	M18 FOPH-CSA	QUIK-LOK™ chainsaw attachment	4932464957	4058546229023
4.	M18 FOPH-EA	QUIK-LOK™ edger attachment	4932464958	4058546229030
5.	M18 FOPH-EXA	QUIK-LOK™ extension attachment	4932464960	4058546229054
6.	M18 FOPH-BCA	QUIK-LOK™ brush cutter attachment	4932479986	4058546377809
7.	M18 FOPH-RBA	QUIK-LOK™ rubber broom attachment	4932479984	4058546377786
8.	M18 FOPH-BBA	QUIK-LOK™ bristle brush attachment	4932479985	4058546377793
9.	M18 FOPH-SHTA	QUIK-LOK™ short hedge trimmer attachment	4932492666	4058546475376
10.	M18 FOPH-CA	QUIK-LOK™ cultivator attachment	4932492667	4058546475383
11.	M18 FOPH-BA	QUIK-LOK™ blower attachment	4932492668	4058546475390
12.	M18 FOPH-RA	QUIK-LOK™ reciprocator attachment	4932492669	4058546475406





RUN TIME DATA

APPLICATION	PRODUCT NAME	BATTERY					
		M18 HB3	M18 B4	M18 B5	M18 HB5.5	M18 HB8	M18 HB12
HEDGE TRIMMERS							
NO LOAD RUN-TIME AT FULL THROTTLE <i>(SIMULATES LIGHT TRIMMING APPLICATION)</i>	M18 FHET60 / M18 FHET45	52 min	56 min	70 min	105 min	140 min	211 min
TRIMMING - HIGH MODE	M18 FOPH-HTA	26 min	35 min	44 min	52 min	70 min	105 min
NO LOAD RUN TIME AT FULL THROTTLE <i>(SIMULATES LIGHT TRIMMING APPLICATION)</i>	M18 FOPH-SHTA	22 min	30 min	37 min	45 min	60 min	90 min
BRUSH CUTTERS							
TRIMMING - HIGH MODE <i>*MEASURED UNDER NO LOAD SPEED, SIMULATES LIGHT GRASS TRIMMING APPLICATION</i>	M18 FBCU	12 min	13 min	16 min	24 min	33 min	49 min
TRIMMING - LOW MODE <i>*MEASURED UNDER NO LOAD SPEED, SIMULATES LIGHT GRASS TRIMMING APPLICATION</i>		22 min	23 min	29 min	44 min	58 min	88 min
TRIMMING - HIGH MODE <i>NO LOAD RUN-TIME WITH THE BLADE AT FULL THROTTLE (SIMULATES LIGHT BRUSH TRIMMING)</i>	M18 FOPH-BCA	23 min	30 min	38 min	46 min	61 min	91 min
GRASS TRIMMERS							
TRIMMING - HIGH MODE <i>*MEASURED UNDER NO LOAD SPEED, SIMULATES LIGHT GRASS TRIMMING APPLICATION</i>	M18 BLLT	13 min	17 min	22 min	26 min	35 min	53 min
	M18 FOPH-LTA	12 min	16 min	20 min	24 min	33 min	50 min
	M18 FOPH-RA	11 min	15 min	18 min	22 min	30 min	45 min
TRIMMING -LOW MODE <i>*MEASURED UNDER NO LOAD SPEED, SIMULATES LIGHT GRASS TRIMMING APPLICATION</i>	M18 BLLT	26 min	35 min	43 min	54 min	70 min	105 min
	M18 FOPH-LTA	22 min	29 min	36 min	44 min	59 min	88 min
	M18 FOPH-EA	40 min	53 min	66 min	79 min	106 min	160 min
BLOWERS							
TOUGH BLOWING - HIGH MODE	M18 F2BPB (WITH 4 X M18 BATTERIES)	OPTIMISED FOR HIGH OUTPUT™			15 min	20 min	30 min
MID BLOWING - MID MODE					22 min	30 min	45 min
LOW BLOWING - LOW MODE					30 min	40 min	60 min
TOUGH BLOWING - HIGH MODE	M18 F2BL (WITH 2 X M18 BATTERIES)	OPTIMISED FOR HIGH OUTPUT™			13 min	18 min	26 min
MID BLOWING - MID MODE					33 min	44 min	66 min
TOUGH BLOWING - HIGH MODE	M18 FBGL3	5 min	6 min	8 min	10 min	13 min	19 min
	M18 FOPH-BA	4 min	6 min	7 min	9 min	12 min	18 min
CHAINSAWS							
LOG CUTTING CUTS IN 10CM CEDAR	M18 FCHSC	38 cuts	50 cuts	63 cuts	75 cuts	100 cuts	150 cuts
	M18 FCHS35	38 cuts	50 cuts	63 cuts	75 cuts	100 cuts	150 cuts
	M18 FCHS	38 cuts	50 cuts	63 cuts	75 cuts	100 cuts	150 cuts
	M18 FTHCHS30	56 cuts	75 cuts	93 cuts	112 cuts	150 cuts	225 cuts
	M18 FTHCHS35	56 cuts	75 cuts	93 cuts	112 cuts	150 cuts	225 cuts
	M18 FHS20	90 cuts	120 cuts	150 cuts	180 cuts	240 cuts	360 cuts
M18 RED LITHIUM FORGE™					M18 FB6	M18 FB8	M18 FB12
LOG CUTTING CUTS IN 40CM HARDWOOD	M18 F2CHS50 (WITH 2 X M18 BATTERIES)	OPTIMISED FOR FORGE™			12 cuts	16 cuts	24 cuts

M18 **M12**

RUN TIME DATA

APPLICATION	PRODUCT NAME	BATTERY						
M18		M18 HB3	M18 B4	M18 B5	M18 HB5.5	M18 HB8	M18 HB12	
POLE SAWS								
LOG CUTTING CUTS IN 15CM CEDAR		M18 FTSP30	17 cuts	23 cuts	29 cuts	35 cuts	46 cuts	70 cuts
PRUNING CUTS IN 7,5CM OAK		M18 FOPH-CSA	62 cuts	82 cuts	103 cuts	123 cuts	166 cuts	247 cuts
BRUSHES								
HIGH MODE <i>*MEASURED UNDER LOAD MOVING WOOD CHIPS AND DIRT AT FULL THROTTLE</i>		M18 FOPH-BBA	11 min	14 min	18 min	22 min	29 min	43 min
		M18 FOPH-RBA	9 min	12 min	15 min	18 min	25 min	37 min
LAWN MOWERS								
GRASS CUTTING <i>*REMOVING 2.5 CM OF GRASS AT 4.8 KM/H</i>		M18 F2LM53 (WITH 2 X M18 BATTERIES)	OPTIMISED FOR HIGH OUTPUT™			1000 m ²	1300 m ²	2000 m ²
		M18 F2LM46 (WITH 2 X M18 BATTERIES)				1200 m ²	1600 m ²	2400 m ²
SHEARS								
BRANCH CUTTING CUTS IN 2.5CM SOFTWOOD		M18 BLTS	1000 cuts	1300 cuts	1650 cuts	2000 cuts	2650 cuts	4000 cuts
SPRAYERS								
SPRAYING <i>*NUMBER OF TANKS ON SPEED ONE WHICH IS EQUIVALENT TO LIGHT SPRAYING</i>		M18 BFPF-CST	9 tanks	12 tanks	15 tanks	18 tanks	24 tanks	36 tanks
CULTIVATORS								
CULTIVATE - HIGH MODE <i>MEASURED UNDER LOAD TO CULTIVATE SOIL</i>		M18 FOPH-CA	5 min	7 min	9 min	11 min	15 min	22 min

APPLICATION	PRODUCT NAME	BATTERY						
M12		M12 B2	M12 B3	M12 B4	M12 B6	M12 HB2.5	M12 HB5	
HATCHET SAWS								
LOG CUTTING CUTS IN 5CM OAK		M12 FHS	60 cuts	90 cuts	120 cuts	180 cuts	86 cuts	172 cuts
HEDGE TRIMMERS								
LIGHT TRIMMING <i>*NO LOAD RUN TIME AT FULL THROTTLE (SIMULATES LIGHT TRIMMING APPLICATION)</i>		M12 FHT	25 min	37 min	50 min	75 min	36 min	72 min
SPRAYERS								
SPRAYING <i>*FIRST MODE - SPOT SPRAYING</i>		M12 BHCS3L	300 litres	450 litres	600 litres	900 litres	431 litres	862 litres
SHEARS								
BRANCH CUTTING CUTS IN 1,25 CM SOFTWOOD		M12 BLPRS	1000 cuts	1500 cuts	2000 cuts	3000 cuts	1400 cuts	2800 cuts

**SCAN TO VIEW OUR
OPE RANGE**



*Charge times are based on a fully-charged battery. These given guidelines are indicative only and may not be replicated due to the varying usage conditions. Results can vary depending on the user and the application.

TRUEVIEW™

1 TRUEST COLOUR ACCURACY



- True representation of colours and details
- Neutral white light for greatest clarity and comfort
- Designed to represent sunlight at 10 am or 2 pm

SCAN HERE FOR MORE INFORMATION

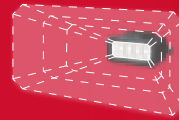

2 BEST-IN-CLASS BEAM PATTERN OPTICS

- Even and consistent beam pattern from edge to edge
- Accurate and efficient work environment, no hot spots or washed-out borders
- Reflectors and diffusers optimised for each light

3 REDLITHIUM™ BATTERY TECHNOLOGY

- Portable solutions
- Long lasting reliability
- System compatibility



MXF TL MX FUEL™ TOWER LIGHT



- TRUEVIEW™ high definition light output with up to 27,000 lumens in AC and up to 20,000 lumens in DC mode for both task and area lighting
- Has the ability to manoeuvre the light heads in multiple orientations, allowing the user to direct light to wherever it's needed

MXF TL-601

Kit included	1 x MXF XC406 Battery pack, Integrated charger, No kitbox or bag supplied
Article Number	4933471844
EAN Code	4058546297435

MXF TLIC MX FUEL™ COMPACT SITE LIGHT



- TRUEVIEW™ high definition light output with up to 15,000 lumens in AC and DC mode for both task and area lighting
- Has the ability to manoeuvre the light head, allowing the user to direct light to wherever it's needed
- Low weight of 17 kg without battery allows for easy transportation across wet and uneven job site terrains with minimum effort

MXF TLIC-0

MXF TLIC-601

Kit included	No batteries supplied, No charger supplied, No kitbox or bag supplied	1 x MXF XC406 Battery pack, MXF FC Charger, No kitbox or bag supplied
Article Number	4933498075	4933498072
EAN Code	4058546512354	4058546512323

M18 ONESLDP M18™ ONE-KEY™ LED COMPACT SITE LIGHT CHARGER



- Optimise brightness and run time by adjusting the light output from 0 - 9000 lumens
- ONE-KEY™ tool customisation allows user to control brightness and set light settings remotely
- ONE-KEY™ tool tracking & security offers a free of charge cloud-based tracking network and inventory management platform for your tools. ONE-KEY™ also features a remote locking functionality

M18 ONESLDP-0

Kit included	No batteries supplied, No charger supplied, No kitbox or bag supplied
Article Number	4933459160
EAN Code	4002395287154

M18 ONESLSP M18™ ONE-KEY™ LED COMPACT SITE LIGHT



- ONE-KEY™ tool customisation allows user to control brightness and set light settings remotely
- ONE-KEY™ tool tracking & security offers a free of charge cloud-based tracking network and inventory management platform for your tools. ONE-KEY™ also features a remote locking functionality
- Optimise brightness and run time by adjusting the light output between 0 - 4400 lumens

M18 ONESLSP-0

Kit included	No batteries supplied, No charger supplied, No kitbox or bag supplied
Article Number	4933459155
EAN Code	4002395287109

M18 TAL
M18™ TRADESMAN AREA LIGHT

M18

TRUEVIEW™



- TRUEVIEW™ high definition lighting with 2,200 lumens of light output in Area mode and 1,000 lumens in Flood mode
- Advanced LED technology provides 360° of area light, while an independent array of LEDs on the side provide 90° of task lighting
- Compact design allowing for one-handed transport on the jobsite, with a built-in carry handle

M18 TAL-0

Kit included	No batteries supplied, No charger supplied, No kitbox or bag supplied
Article Number	4933464134
EAN Code	4058546220792

M18 ONERSAL
M18™ ONE-KEY™ LED REMOTE STAND LIGHT

M18

TRUEVIEW™



- Optimise brightness and run time by adjusting the light output from 0 - 5400 lumens
- ONE-KEY™ tool customisation allows user to control brightness and set light settings remotely
- ONE-KEY™ tool tracking & security offers a free of charge cloud-based tracking network and inventory management platform for your tools. ONE-KEY™ also features a remote locking functionality

M18 ONERSAL-0

Kit included	No batteries supplied, No charger supplied, No kitbox or bag supplied
Article Number	4933459431
EAN Code	4058546010928

M18 HOSALC
M18™ HIGH OUTPUT STAND AREA LIGHT CHARGER

M18

TRUEVIEW™



- 6000 lumens TRUEVIEW™ of High Definition Output
- Up to 10 hours of run time on M18™ REDLITHIUM™ 8.0 Ah battery pack
- 3 impact resistant adjustable heads with highly durable lens can be rotated 180° vertically and pivoted 240° horizontally to have the perfect workplace illumination
- Integrated M18™ charger and 2.1 AMP USB output for USB device charging

M18 HOSALC-0

Kit included	No batteries supplied, No charger supplied, No kitbox or bag supplied
Article Number	4933478116
EAN Code	4058546340490

M18 SAL2
M18™ LED STAND LIGHT

M18

TRUEVIEW™



- TRUEVIEW™ high definition lighting
- Twelve high performance LEDs provides up to 2800 lumens on high light output
- Impact resistant adjustable head with highly durable polycarbonate lens can be rotated 230° vertically and pivoted 240° horizontally
- Protective guard secures the head and lens when the light is collapsed for storage or transport

M18 SAL2-0

M18 SAL2-502B

Kit included	No batteries supplied, No charger supplied, No kitbox or bag supplied	2 x M18 B5 Battery packs, M12-18 C Tool bag
Article Number	4933492486	4933492903
EAN Code	4058546418533	4058546477745

M12 SAL
M12™ STAND LIGHT

M12

TRUEVIEW™



- TRUEVIEW™ high definition lighting
- 12 high performance LEDs provide 1400 lumens on high light output
- Impact resistant adjustable head with highly durable polycarbonate lens to withstand drops up to 3 m
- Head can be rotated 210° vertically and pivoted 270° horizontally to have the best perfect workplace illumination

M12 SAL-0

Kit included	No batteries supplied, No charger supplied, No kitbox or bag supplied
Article Number	4933464823
EAN Code	4058546227685

M18 POALC
M18™ PACKOUT™ AREA LIGHT CHARGER

M18

TRUEVIEW™

PACKOUT™



- Three independent pivoting light heads provide 3000 lumens of TRUEVIEW™ High Definition Output
- All three pivot light heads combined provide up to 12 hours of run time on a M18™ REDLITHIUM™ 5.0 Ah battery pack
- IP54: water and dust resistant

M18 POALC-0

Kit included	No batteries supplied, No charger supplied, No kitbox or bag supplied
Article Number	4933478120
EAN Code	4058546340537

M12 POAL
M12™ PACKOUT™ AREA LIGHT 1400 LUMENS

M12

TRUEVIEW™ **PACKOUT™**



- 1400 Lumens of TRUEVIEW™ high definition output
- IP 54: water and dust resistant
- 3 modes to manage output and run time
- 300° of horizontal rotation and 180° of vertical rotation for complete light head adjustability
- Storage compartment for devices and small items

M12 POAL-0

Kit included	No batteries supplied, No charger supplied, No kitbox or bag supplied
Article Number	4933480473
EAN Code	4058546407582

M18 HOAL
M18™ HIGH OUTPUT AREA LIGHT

M18

TRUEVIEW™



- 4000 lumens TRUEVIEW™ of High Definition Output
- Up to 12 hours of run time on M18™ REDLITHIUM™ 5.0 Ah battery pack
- 120° rotatable light head and integrated key holes for horizontal and vertical hanging
- Impact resistant design and durable roll cage to protect the light from rough jobsite conditions

M18 HOAL-0

Kit included	No batteries supplied, No charger supplied, No kitbox or bag supplied
Article Number	4933478118
EAN Code	4058546340513

M18 AL M18™ LED AREA LIGHT

M18

TRUEVIEW™



- TRUEVIEW™ high definition lighting
- Eight high performance LEDs provide 1500 lumens of light output - up to 30% brighter than 250 W halogen lights
- Compact roll cage design provides superior durability
- Convenient built-in handle - ability to hang vertically or horizontally

M18 AL-0

Kit included	No batteries supplied, No charger supplied, Blister packaging
Article Number	4932430392
EAN Code	4002395380534

M12 AL M12™ LED AREA LIGHT

M12

TRUEVIEW™



- TRUEVIEW™ high definition lighting
- Five high performance LEDs provide 1000 lumens of light output replacing 250 W halogen lights
- Highly durable and impact resistant polycarbonate lens to withstand drops up to 2.7 metres
- Integrated magnets, clamping mechanism, and key hole for screws / nails provide multiple mounting options for different surfaces

M12 AL-0

Kit included	No batteries supplied, No charger supplied, Blister packaging
Article Number	4933451394
EAN Code	4002395158621

M18 PAL2 M18™ PIVOTING AREA LIGHT

M18

TRUEVIEW™



- TRUEVIEW™ high definition lighting with up to 2,000 lumens
- Up to 24 hours of run time on M18™ 5.0 Ah battery pack
- 3 modes to manage output and run time
- Magnetic mounting and up to 7.5 cm clamp opening
- 359° of horizontal rotation and 160° of vertical rotation for complete light head adjustability

M18 PAL2-0

Kit included	No batteries supplied, No charger supplied, No kitbox or bag supplied
Article Number	4933493547
EAN Code	4058546484187

M12 PAL M12™ PIVOT AREA LIGHT

M12

TRUEVIEW™



- TRUEVIEW™ high definition lighting with up to 700 lumens
- Up to 24 hours of run time on M12™ 4.0 Ah battery pack
- With powerful magnets as well as a rotating light head design with 110° rotation in each direction to provide multiple beam options
- Highly durable and impact resistant design to withstand drops up to 3 m

M12 PAL-0

Kit included	No batteries supplied, No charger supplied, Blister packaging
Article Number	4933478226
EAN Code	4058546344030

M18 ABL M18™ AREA BOOM LIGHT

M18

TRUEVIEW™



- TRUEVIEW™ high definition lighting with up to 2,500 lumens
- Up to 12 hours of run time on M18 B5 battery pack
- Designed for the on-the-go needs of maintenance and service trades of large vehicles
- 890° of horizontal rotation and 900° of vertical rotation for complete light head adjustability
- 3 modes to manage output

M18 ABL-0

Kit included	No batteries supplied, No charger supplied, No kitbox or bag supplied
Article Number	4933498147
EAN Code	4058546513078

M18 ALIS M18™ SERVICE AREA LIGHT

M18

TRUEVIEW™



- TRUEVIEW™ high definition lighting with up to 1,000 lumens
- Up to 110 hours of run time on M18™ 5.0 Ah battery pack
- USB-A (15 W) & USB-C (27 W) small device charging
- Integrated rafter hook
- Horizontal and vertical lighting head mobility
- Most compact light on the M18™ platform

M18 ALIS-0

Kit included	No batteries supplied, No charger supplied, No kitbox or bag supplied
Article Number	4933498148
EAN Code	4058546513085

M18 MDTL M18™ MULTI-DIRECTIONAL TASK LIGHT

M18

TRUEVIEW™



- TRUEVIEW™ high definition lighting with up to 4,500 lumens
- 3 individual light heads for task or area lighting
- 9 total output modes to manage output or run time
- Magnetic base, integrated hook, and screw holes for optimal surface mounting
- 270° horizontal rotation and 270° vertical articulation
- Integrated handles for easy carrying

M18 MDTL-0

Kit included	No batteries supplied, No charger supplied, No kitbox or bag supplied
Article Number	4933498149
EAN Code	4058546513092

M18 SLED M18™ LED SEARCH LIGHT

M18

TRUEVIEW™



- TRUEVIEW™ high definition lighting
- Pivoting head provides 1250 lumens with up to 650 m beam distance
- 4 output modes: Spot, Flood, Spot/Flood, Strobe delivering multiple options in workspace illumination
- Spot mode for long range identification: utility pole/ high voltage cable inspection, inspection of long runs of conduit, cast or copper pipe, under ground work, bridge work...

M18 SLED-0

Kit included	No batteries supplied, No charger supplied, No kitbox or bag supplied
Article Number	4933459159
EAN Code	4002395287147

M12 SLED
M12™ LED SPOT LIGHT

M12

TRUEVIEW™



- TRUEVIEW™ high definition lighting
- Up to 35% longer beam distance than competition - 650 m intense and highly focused beam of light with 750 lumens
- Especially useful for long range identification - utility pole/high voltage cable inspection, inspection of long runs of conduit, cast or copper pipe, under ground work, bridge work

M12 SLED-0

Kit included	No batteries supplied, No charger supplied, Blister packaging
Article Number	4933451261
EAN Code	4002395170159

M18 IL
M18™ LED INSPECTION LIGHT

M18

TRUEVIEW™



- TRUEVIEW™ high definition lighting
- Three LED design with 2 light settings provides 300 lumens on High and 130 lumens on Low setting
- Pivoting 45° forward & backward head allows for 180° coverage
- 2 adjustable metal hooks for hanging in vertical and horizontal position
- Thanks to its compact design it operates in locations other lights cannot

M18 IL-0

Kit included	No batteries supplied, No charger supplied, Blister packaging
Article Number	4932430564
EAN Code	4002395382255

M12 SL
M12™ LED STICK LIGHT

M12

TRUEVIEW™



- TRUEVIEW™ high definition lighting
- Powerful three LED design provides 220 lumens
- Adjustable metal hook allows for light to be hung in multiple orientations when being used
- Compact design - operates in locations other lights cannot
- Flexible battery system: works with all MILWAUKEE® M12™ batteries

M12 SL-0

Kit included	No batteries supplied, No charger supplied, Blister packaging
Article Number	4932430178
EAN Code	4002395378395

M12 UCL
M12™ UNDERCARRIAGE LIGHT

M12

TRUEVIEW™



- TRUEVIEW™ high definition lighting with up to 1,200 Lumens
- Up to 15 hours of run time on M12™ 4.0 Ah battery pack
- Designed for the on-the-go needs of automotive maintenance and service trades
- Dual joints swivel 300° horizontally and 180° vertically to ensure full undercarriage illumination coverage

M12 UCL-0

Kit included	No batteries supplied, No charger supplied, No kitbox or bag supplied
Article Number	4932478868
EAN Code	4058546361501

M12 CML
M12™ COLOUR MATCHING LIGHT

M12

TRUEVIEW™



- High definition lighting with up to 1000 lumens
- 98+ colour rendering index for use to identify accurate and reliable colour recognition
- Featuring 5 different colour temperatures, for end users to replicate real sunlight requirements
- Up to 14 hours of run time on M12™ 4.0 Ah battery pack
- IP54 rated for water and dust resistant and 2 m impact resistant

M12 CML-401

Kit included	1 x M12 B4 Battery pack, C12 C Charger, No kitbox or bag supplied
Article Number	4932479366
EAN Code	4058546371609

M12 UHL
M12™ LED UNDERHOOD LIGHT

M12

TRUEVIEW™



- TRUEVIEW™ high definition light output delivers consistent beam, optimised colour temperature and true representation of colours and detail
- Two light output settings with 1350 and 600 lumens to maximise run time and to optimise lighting output
- M12™ 4.0 Ah battery provides 4 hours of run time in high and 8 hours of run time in low setting

M12 UHL-0

Kit included	No batteries supplied, No charger supplied, No kitbox or bag supplied
Article Number	4932459432
EAN Code	4058546010935

M18 LL
M18™ LED LANTERN LIGHT

M18

TRUEVIEW™



- TRUEVIEW™ high definition lighting
- 180° - 360° adjustable beam - versatile design, allows the user to select between area lighting and task lighting
- Best-in-class performance - outstanding light output 700 lumens, designed to illuminate large areas
- High powered USB charger charges tablets, smart phones, MP3 players and other electronic devices

M18 LL-0

Kit included	No batteries supplied, No charger supplied, Blister packaging
Article Number	4932430563
EAN Code	4002395382248

M12 LL
M12™ LED LANTERN LIGHT

M12

TRUEVIEW™



- TRUEVIEW™ high definition lighting
- 180° - 360° adjustable beam - versatile design, allows the user to select between area lighting and task lighting
- Best-in-class performance - outstanding light output 400+ lumens, designed to illuminate large areas
- High powered 2.1A USB charger charges tablets, smart phones, MP3 players and other electronic devices

M12 LL-0

Kit included	No batteries supplied, No charger supplied, Blister packaging
Article Number	4932430562
EAN Code	4002395382231

M18 TLED M18™ LED TORCH

M18

TRUEVIEW™



- The 120 lumen LED light is 2x brighter and whiter than conventional incandescent bulbs
- M18™ LED electronics deliver 2x longer run time on a single charge with less heat than conventional removable light bulbs
- Sealed aluminium head is designed for impact- and weather-resistant durability
- 135° rotating head allows the user to easily direct the light beam at the desired work area
- Integrated hook for hands-free use

M18 TLED-0

Kit included	No batteries supplied, No charger supplied, Blister packaging
Article Number	4932430361
EAN Code	4002395380220

M12 TLED M12™ LED TORCH

M12

TRUEVIEW™



- The 120 lumen LED light is 2x brighter and whiter than conventional incandescent bulbs
- M12™ LED electronics deliver 2x longer run time on a single charge with less heat
- Sealed aluminium head is designed for impact- and weather-resistant durability
- 90° rotating head allows the user to easily direct the light beam at the desired work area
- Magnetic back for hands-free use

M12 TLED-0

Kit included	No batteries supplied, No charger supplied, Blister packaging
Article Number	4932430360
EAN Code	4002395380213

PERSONAL LIGHTS





REDLITHIUM™ USB

REDLITHIUM
USB

		Lumen	Max. run time (h)	IP protection class	Features	Kit included	Article Number	EAN Code
	L4 FL-301	445/ -/ 100/ -	2.5/ -/ 12.5/ -	IP54	Magnet, Clip	1 x L4 B3 Battery pack, USB cable, Blister packaging	4933479763	4058546375577
	L4 PWL-301	400/ -/ 100/ 500	3.5/ -/ 11.75/ 3.5	IP54	Magnet, Clip	1 x L4 B3 Battery pack, USB cable, Blister packaging	4933479765	4058546375591
	L4 FFL-301	550/ 250/ 100/ -	2.5/ 6/ 13.25/ -	IP54	Magnet, Carabiner	1 x L4 B3 Battery pack, USB cable, Blister packaging	4933479766	4058546375607
	L4 HL-VIS-301	600/ 400/ 200/ 25/ 400	2.5/ 4.5/ 8.5/ 22/ 4.5	IP53	Hard hat clips	1 x L4 B3 Battery pack, USB cable, Blister packaging	4933479768	4058546375621
	L4 HLRP-301	600/ 350/ 125/ 25	3/ 7.5/ 13/ 28	IP54	Hard hat clips	1 x L4 B3 Battery pack, USB cable, Blister packaging	4933479767	4058546375614
	L4 TML-301	1100/ 600/ 100/ -	1.5/ 4/ 12/ -	IP67	Clip	1 x L4 B3 Battery pack, USB cable, Blister packaging	4933479769	4058546375638
	L4 FML-301	800/ -/ 100/ -	2.5/ -/ 10/ -	IP67	Clip	1 x L4 B3 Battery pack, USB cable, Blister packaging	4933479770	4058546375645
	L4 SL550-301	550/ 250 ; 250/ 100	2/ 4.5/ 2/ 5	IP52	Magnet, Hook	1 x L4 B3 Battery pack, USB cable, Blister packaging	4933478869	4058546361518
	L4 NL400-301	400/ 250	2.5/ 8	IP50	-	1 x L4 B3 Battery pack, USB cable, Blister packaging	4933479898	4058546376925
	L4 BOLTHL-301	600/ 400/ 150/ 25	4/ 8/ 14/ 32	IP54	-	1 x L4 B3 Battery pack, USB cable, Blister packaging	4933479902	4058546376963
	L4 HL2-301	600/ 100/ 400/ 100/ 400	5/ 20/ 9/ 14/ 9	IP54	Hard hat clips	1 x L4 B3 Battery pack, USB cable, Blister packaging	4933479963	4058546377571
	L4 FL2000-301	2000/ 1300/ 800/ 100	4/ 8/ 24	IP66	Clip	1 x L4 B3 Battery pack, USB cable, Blister packaging	4933479637	4058546374310
	L4 HSL-301	350	2.5/ 10	IP54	-	1 x L4 B3 Battery pack, USB cable, No kitbox or bag supplied	4933493968	4058546511289







INTERNAL RECHARGEABLE

RECHARGEABLE

		Lumen	Max. run time (h)	IP protection class	Features	Kit included	Article Number	EAN Code
	IR FFL	500	4/ 8/ 12	IP54	Carabiner, Magnet	Integrated battery, USB cable, No kitbox or bag supplied	4933493528	4058546483999
	IR HL450	450/ 100/ 250/ 50/ 250	2.5/ 8/ 4/ 14/ 4	IP54	Magnet, Hard hat clips, BOLT™ Low-profile headlamp mount	Integrated battery, USB cable, Blister packaging	4933478587	4058546347802
	IR FL500	500 / 100 / 10/ -	3.5 / 16/ 40/ -	IP67	Clip	Integrated battery, USB cable, Blister packaging	4933478586	4058546347796
	IR PL250	250/ -/ 50/ -	1.5/ - / 8/ -	IP67	Bite zone, Clip	Integrated battery, USB cable, Blister packaging	4933478705	4058546348984

ALKALINE



		Lumen	Max. run time (h)	IP protection class	Features	Kit included	Article Number	EAN Code
	IPL-LED	100	3	IP67	Clip, Bite zone	2 x AAA Batteries, Blister packaging	4933459440	4058546011017
	ML-LED	325/ -/ 25/ -	5/ -/ 18/ -	IP67	Clip	3 x AAA Batteries, Blister packaging	4933464825	4058546227708
	FL-LED	300/ -/ 100/ -	5/ -/ 16/ -	IP54	Magnet, Clip	2 x AA Batteries, Blister packaging	4933464824	4058546227692
	HL-SF	450/ 350/ 150/ 25/ 350	2/ 4/ 10/ 26/ 4	IP52	Hard hat clips, BOLT™ Low-profile headlamp mount	3 x AAA Batteries, Blister packaging	4933471388	4058546290160
	ISHL-LED	310/ 235/ 155/ 25/ 155	4/ 6/ 10/ 40/ 8	IP64	Hard hat clips, BOLT™ Low-profile headlamp mount	3 x AAA Batteries, No kitbox or bag supplied	4933478112	4058546340452
	HL2-LED	350/ 150/ 25/ -	4/ 8.5/ 28/ -	IP52	Hard hat clips, BOLT™ Low-profile headlamp mount	3 x AAA Batteries, Blister packaging	4933471286	4058546289140



BATTERIES



		Description	Charge time M18 PC6/ MPC6 AC charger	Charge time M18 DBSC/ MDBSC AC charger	Charge time M12-18 FC charger	Charge time M12-18 C charger	Charge time M12-18 AC charger	Charge time M1418C6 charger	Charge time M18 DFC charger	Charge time C12 C charger	Charge time M12 TC2 C4 charger	Charge time L4 C charger	Article number	EAN Code
	M18 FB12	M18™ FORGE™ 12.0 Ah battery	130 min	45 min	130 min	250 min	285 min	270 min	130 min	-	-	-	4932492651	4058546414016
	M18 FB8	M18™ FORGE™ 8.0 Ah battery	87 min	45 min	87 min	167 min	190 min	190 min	87 min	-	-	-	4932492131	4058546414986
	M18 FB6	M18™ FORGE™ 6.0 Ah battery	60 min	25 min	60 min	115 min	130 min	125 min	60 min	-	-	-	4932492533	4058546419004
	M18 HB5.5	M18™ HIGH OUTPUT™ 5.5 Ah battery	60 min	35 min	60 min	115 min	130 min	125 min	60 min	-	-	-	4932464712	4058546226572
	M18 HB3	M18™ HIGH OUTPUT™ 3.0 Ah battery	36 min	36 min	36 min	65 min	75 min	70 min	36 min	-	-	-	4932471069	4058546286972
	M18 B5	M18™ 5.0 Ah battery	59 min	59 min	59 min	100 min	100 min	100 min	59 min	-	-	-	4932430483	4002395381449
	M18 B5-CR	M18™ 5.0 Ah battery	59 min	59 min	59 min	100 min	100 min	100 min	59 min	-	-	-	4932479265	4058546370596
	M18 B4	M18™ 4.0 Ah battery	52 min	52 min	52 min	80 min	80 min	80 min	52 min	-	-	-	4932430063	4002395377244
	M18 B2	M18™ 2.0 Ah battery	26 min	26 min	26 min	40 min	40 min	40 min	26 min	-	-	-	4932430062	4002395377237
	M12 HB5	M12™ 5.0 Ah HIGH OUTPUT™ battery pack	-	-	75 min	110 min	110 min	-	-	110 min	300 min	110 min	4932480165	4058546404505
	M12 HB2.5	M12™ 2.5 Ah HIGH OUTPUT™ battery pack	-	-	40 min	55 min	55 min	-	-	55 min	150 min	55 min	4932480164	4058546404499
	M12 B6	M12™ 6.0 Ah battery	-	-	95 min	130 min	165 min	-	-	130 min	347 min	130 min	4932451395	4002395158638
	M12 B4	M12™ 4.0 Ah battery	-	-	52 min	80 min	115 min	-	-	80 min	240 min	80 min	4932430065	4002395377268
	M12 B3	M12™ 3.0 Ah battery	-	-	50 min	70 min	90 min	-	-	70 min	174 min	70 min	4932451388	4002395157969
	M12 B2	M12™ 2.0 Ah battery	-	-	26 min	40 min	55 min	-	-	40 min	120 min	40 min	4932430064	4002395377251
	L4 B3	3.0 Ah REDLITHIUM™ USB battery	-	-	-	-	-	-	-	-	-	120 min	4933478311	4058546345020

CHARGERS



		Description	Charging ports	Charge type	Power source	Carry handle	Wall mountable	Article Number	EAN Code
	M18 MPC6	M18™ mobile PACKOUT™ six bay rapid charger	6 x M18™	Simultaneous	AC	✓	✓	4932498551	4058546524203
	M18 PC6	M18™ PACKOUT™ six bay rapid charger	6 x M18™; 1 x USB	Simultaneous	AC, USB	✓	✓	4932480162	4058546404475
	M18 MDBSC	M18™ mobile dual bay super charger	2 x M18™	Simultaneous	AC	-	✓	4932498557	4058546524265
	M18 DBSC	M18™ dual bay super charger	2 x M18™	Simultaneous	AC	-	✓	4932492531	4058546418984
	M12-18 FC	M12™ - M18™ fast charger	1 x M12™, 1 x M18™	Sequential	AC	-	✓	4932451079	4002395810581
	M12-18 C	M12™ - M18™ charger	1 x M12™, 1 x M18™	Sequential	AC	-	✓	4932352959	4002395376179
	M12-18 AC	M12™-M18™ car charger	1 x M12™, 1 x M18™	Sequential	DC	-	✓	4932459205	4002395287208
	M18 DFC	M18™ dual bay rapid charger	2 x M18™	Simultaneous	AC	-	✓	4932472073	4058546324698
	M1418 C6	M14™ - M18™ multibay charger	6 x M14™ or 6 x M18™	Sequential	AC	✓	✓	4932430086	4002395377473
	C12 C	M12™ charger	1 x M12™	Single	AC	-	✓	4932352000	4002395366606
	M12 TC2-0	M12™ compact charger and power source 2	1 x M12™	Single	AC, USB	-	☒	4932492908	4058546477790
	M12 C4	M12™ 4 bay charger	4 x M12™	Sequential	AC	-	✓	4932430554	4002395382156

CONSTRUCTION

BREAKERS



		Tool reception	Power input (W)	Blow energy (EPTA)(J)	No load speed (rpm)	Full load hammer action (bpm)	Full load speed (soft hammer) (rpm)
1.	K 2628 H	K-Hex	2400	64	-	1200	-
2.	K 1530 H	K-Hex	2100	39	-	1560	-
3.	K 1528 H	K-Hex	2100	39	-	1560	-
4.	K 1000 S	SDS-Max	1750=	26	-	1400 - 1950	-
5.	K 950 S	SDS-Max	1700	20	125 - 250	975 - 1950	125 - 250
6.	K 900 K	K-Hex	1600	20	-	975 - 1950	-
6.	K 900 S	SDS-Max	1600	20	-	975 - 1950	-
7.	HAC0850	SDS-Max	1470	11.0	-	1600 - 2900	210 - 385
8.	K 750 S	SDS-Max	1550	11.9	300	2740	240
9.	K 545 S	SDS-Max	1300	8.5	450	2840	350
10.	K 540 S	SDS-Max	1100	7.5	450	3000	430
11.	K 500 S	SDS-Max	1300	8.5	-	2840	2200
12.	PCE 3/K	SDS-Plus	720	3.6	-	0 - 3650	-

COMBI HAMMERS



		Tool reception	Power input (W)	Blow energy (EPTA)(J)	Full load hammer action (bpm)	Full load speed (rpm)	Max. drilling concrete (mm)
1.	PLH 32 XE	SDS-Plus + Reduced shank 13 mm	900	3.8	0 - 4500	0 - 800	32
2.	PLH 28 E	SDS-Plus	800	4.1	0 - 4000	0 - 1000	28
2.	PLH 28 XE	SDS-Plus + Reduced shank 13 mm	800	4.1	0 - 4000	0 - 1000	28
3.	PH 30 POWER X	SDS-Plus + Reduced shank 13 mm	1030	3.6	0 - 3800	0 - 850	30
4.	PH 28	SDS-Plus	820	3.4	0 - 4000	0 - 900	28
4.	PH 28 X	SDS-Plus + Reduced shank 13 mm	820	3.4	0 - 4000	0 - 900	28
5.	PH 26 T	SDS-Plus	800	2.4	0 - 4500	0 - 1500	26
5.	PH 26 TX	SDS-Plus	800	2.4	0 - 4500	0 - 1500	26
6.	PFH 26 T	SDS-Plus	800	2.4	0 - 4500	0 - 1500	26
7.	PFH 26	SDS-Plus	725	2.4	0 - 4500	0 - 1250	26

**SCAN HERE FOR
MORE INFORMATION**



Max. drilling solid bit (mm)	Max. drilling tunnel bit (mm)	Max. drilling core bit (mm)	Vibration drilling (m/s ²)	Vibration chiseling (m/s ²)	Weight (kg)	Supplied in	Article Number	EAN Code
-	-	-	-	6.2	25.7	No kitbox or bag supplied	4933471685	4058546295844
-	-	-	-	8.4	16.8	Plastic case	4933464117	4058546220624
-	-	-	-	8.8	17.2	Plastic case	4933464118	4058546220631
-	-	-	-	6.7	12.7	Plastic case	4933464120	4058546220655
50	80	150	12.5	11	11.8	Kitbox	4933375710	4002395232031
-	-	-	-	11	11.0	Kitbox	4933375650	4002395231614
-	-	-	-	11	11.0	Kitbox	4933375720	4002395232048
-	65	150	-	11	9.7	Kitbox	4933498603	4058546524722
50	80	150	9.5	9.1	8.2	Kitbox	4933398600	4002395235193
45	65	100	13	9	6.7	Kitbox	4933398200	4002395234073
40	65	105	16.8	16.7	6.3	Kitbox	4933418100	4002395238422
-	-	-	-	11.5	6.3	Kitbox	4933398220	4002395234059
-	-	-	-	11	3.7	Kitbox	4933384300	4002395232215

Max. drilling steel (mm)	Max. drilling wood (mm)	Vibration drilling (m/s ²)	Vibration chiseling (m/s ²)	FIXTEC™	Weight (kg)	Supplied in	Article Number	EAN Code
16	40	22	20	Yes	3.6	Kitbox	4933400069	4002395233342
13	40	10.6	6.8	No	3.4	Kitbox	4933446790	4002395005482
13	40	10.6	6.8	Yes	3.6	Kitbox	4933446800	4002395005499
13	40	22	14	Yes	2.9	Kitbox	4933396420	4002395234967
13	30	22	16	No	2.7	Kitbox	4933396396	4002395234936
13	30	22	16	Yes	2.9	Kitbox	4933396392	4002395234943
13	30	13.6	11.9	No	2.4	Kitbox	4933464580	4058546225254
13	30	13.6	11.9	Yes	2.6	Kitbox	4933464579	4058546225247
13	30	13.6	11.9	No	2.4	Kitbox	4933464581	4058546225261
13	30	13.5	-	No	2.4	Kitbox	4933428230	4002395239832

ROTARY DRILLS AND DRIVERS



		Chuck capacity (mm)	Power input (W)	No load speed (rpm)	Max. drilling concrete (mm)	Max. drilling masonry (mm)
1.	SB 2-35 D	16	1010	0 - 800/ 0 - 1800	35	40
2.	PD2E 24 R	13	1020	0 - 1000/ 0 - 3200	22	24
3.	PD2E 22 R	13	850	0 - 1000/ 0 - 3200	20	22
4.	PD-705	13	705	0 - 3000	15	16
5.	PDE 16 RP	13	630	0 - 950	16	20
6.	PDE 13 RX	13	630	0 - 2900	15	18
7.	HDE 13 ROX	13	950	0 - 850	-	-
8.	HDE 13 ROX KIT	13	950	0 - 850	-	-
9.	DE 13 RP	13	630	0 - 950	-	-

BRT BREAKER TROLLEY



BRT

Article Number 4933459794
EAN Code 4058546029661

IPWE 400 R 1/2" DRIVE IMPACT WRENCH



IPWE 400 R

Article Number 4933451524
EAN Code 4002395143511

IPWE 520 R 3/4" DRIVE IMPACT WRENCH



IPWE 520 R

Article Number 4933451525
EAN Code 4002395143528

DD 2-160 XE 2-SPEED DRY DIAMOND DRILL



DD 2-160 XE

Article Number 4933368690
EAN Code 4002395232505

DD 3-152 3-SPEED COMBI DIAMOND DRILL



DD 3-152

Article Number 4933428000
EAN Code 4002395239801



**SEE PAGE 109
OR SCAN TO
VIEW OUR WET
DIAMOND DRILLING
ACCESSORIES
RANGE**



Max. drilling steel (mm)	Max. drilling wood (mm)	Max. static stalling torque (Nm)	Weight (kg)	Supplied in	Article Number	EAN Code
16	50	57	4.2	No kitbox or bag supplied	4933380507	4002395227280
16	40	60	3.0	Kitbox	4933419595	4002395238651
13	40	56	2.9	Kitbox	4933419570	4002395238613
13	30	15	1.9	No kitbox or bag supplied	4933431955	4002395243914
13	40	59	2.0	Kitbox	4933409206	4002395235339
13	30	21	1.8	Kitbox	4933409200	4002395235322
13	38	94	2.0	No kitbox or bag supplied	030250	4002395229642
13	38	94	2.0	Kitbox	4933428550	4002395241576
13	40	59	2.1	Kitbox	4933409194	4002395235346

AGV 15 DEC
1550 W ANGLE GRINDER WITH
DUST MANAGEMENT (28 MM DOC)



AGV 15-125 XC DEC-SET

Article Number	4933448025
EAN Code	4002395006816

AGV 15 DEG
1550 W ANGLE GRINDER WITH
DUST MANAGEMENT



AGV 15-125 XC
DEG-SET AGV 15-125 XE
DEG-SET

Article Number	4933448035	4933448830
EAN Code	4002395006830	4002395263424

AGV 12 DEG
1200 W ANGLE GRINDER WITH
DUST MANAGEMENT



AGV 12-125 X DEG-SET

Article Number	4933448030
EAN Code	4002395006823

AGV 12 DEC
1200 W ANGLE GRINDER WITH
DUST MANAGEMENT (28 MM DOC)



AGV 12-125 X DEC-SET

Article Number	4933448020
EAN Code	4002395006809

WCS 45
1900 W 150 MM (45 MM DOC)
WALL CHASER



WCS 45

Article Number	4933383350
EAN Code	4002395229086

WCE 30
1500 W 125 MM (30 MM DOC)
WALL CHASER



WCE 30

Article Number	4933383855
EAN Code	4002395228980

METAL WORKING

ANGLE GRINDERS



		Power input (W)	No load speed (rpm)	Disc diameter (mm)	Weight (kg)	Switch type	Brake	Anti-kickback protection
1.	AGVM 26-230 GEX	2600	6600	230	5.8	Trigger lock-on switch	No	Yes
1.	AGVM 26-230 GEX DMS	2600	6600	230	5.8	Deadman switch	No	Yes
2.	AGV 26-230 GE	2600	6600	230	5.5	Trigger lock-on switch	No	No
2.	AGV 26-230 GE DMS	2600	6600	230	5.5	Deadman switch	No	No
3.	AGVM 24-230 GEX	2400	6600	230	5.8	Trigger lock-on switch	No	Yes
3.	AGVM 24-230 GEX DMS	2400	6600	230	5.8	Deadman switch	No	Yes
4.	AGVKB 24-230 EKK	2400	6500	230	5.9	Trigger lock-on switch	Yes	Yes
5.	AGVK 24-230 EK	2400	6600	230	5.4	Trigger lock-on switch	No	Yes
5.	AGVK 24-230 EK DMS	2400	6600	230	5.4	Deadman switch	No	Yes
6.	AGV 24-230 GE	2400	6600	230	5.5	Trigger lock-on switch	No	No
7.	AG 24-230 E	2400	6600	230	5.3	Trigger lock-on switch	No	No
7.	AG 24-230 E DMS	2400	6600	230	5.3	Deadman switch	No	No
8.	AGV 22-180 E	2200	8500	180	5.3	Trigger lock-on switch	No	No
8.	AGV 22-230 E	2200	6600	230	5.4	Trigger lock-on switch	No	No
8.	AGV 22-230 DMS	2200	6600	230	5.4	Deadman switch	No	No
9.	AG 22-180 DMS	2200	8500	180	5.1	Deadman switch	No	No
9.	AG 22-230 DMS	2200	6600	230	5.2	Deadman switch	No	No
10.	AGV 17-125 XE	1750	2600 - 11,000	125	2.8	Trigger lock-on switch	No	Yes
10.	AGV 17-125 XC	1750	11,000	125	2.8	Trigger lock-on switch	No	Yes
10.	AGV 17-125 XC DMS	1750	11,000	125	2.8	Deadman switch	No	Yes
10.	AGV 17-150 XC DMS	1750	9500	150	3.0	Deadman switch	No	Yes
10.	AGV 17-180 XC DMS	1750	7600	180	3.1	Deadman switch	No	Yes
11.	AGV 17-125 INOX	1750	2000 - 7600	125	2.8	Trigger lock-on switch	No	Yes
12.	AGV 15-125 XC	1550	11,000	125	2.6	Slide lock-on switch	No	Yes
12.	AGV 15-125 XE	1550	2800 - 11,000	125	2.6	Slide lock-on switch	No	Yes
12.	AGV 15-150 XC	1550	9000	150	2.6	Slide lock-on switch	No	Yes
13.	AGV 13-125 XE	1250	2,800 - 11,500	125	2.4	Slide lock-on switch	No	Yes
14.	AGV 13-125 XSPDEB	1250	12,000	125	2.5	Paddle (Deadman) switch	Yes	Yes
14.	AGV 13-125 XSPDEB KIT	1250	12,000	125	2.5	Paddle (Deadman) switch	Yes	Yes
15.	AGV 13-125 XSPDE	1250	12,000	125	2.5	Paddle (Deadman) switch	No	Yes
16.	AG 13-125 XSPD	1250	12,000	125	2.3	Paddle (Deadman) switch	No	No
17.	AGV 12-125 X	1200	11,000	125	2.4	Slide lock-on switch	No	Yes
18.	AGV 10-125 EK	1000	11,000	125	2.2	Slide lock-on switch	No	No
19.	AG 10-115 EK	1000	11,000	115	2.1	Slide lock-on switch	No	No
19.	AG 10-125 EK	1000	11,000	125	2.1	Slide lock-on switch	No	No
20.	AG 800-125 EK	800	11,500	125	2.0	Slide lock-on switch	No	No
21.	AG 800-115 E	800	11,500	115	2.0	Slide lock-on switch	No	No
21.	AG 800-125 E	800	11,500	125	2.0	Slide lock-on switch	No	No
21.	AG 800-115 E D-SET800	800	11,500	115	2.0	Slide lock-on switch	No	No

**SCAN HERE FOR
MORE INFORMATION**



FIXTEC™	AVS Anti-Vibration System	AVS side handle	Rotatable main handle	Autobalancer system	Line lock out function	Supplied in	Article Number	EAN Code
Yes	Yes	-	Yes	Yes	Yes	No kitbox or bag supplied	4933402365	4002395234271
Yes	Yes	-	Yes	Yes	No	No kitbox or bag supplied	4933402495	4002395234394
No	Yes	-	Yes	Yes	Yes	No kitbox or bag supplied	4933402360	4002395234257
No	Yes	-	Yes	Yes	No	No kitbox or bag supplied	4933402490	4002395234356
Yes	Yes	-	Yes	Yes	Yes	No kitbox or bag supplied	4933402340	4002395234240
Yes	Yes	-	Yes	Yes	No	No kitbox or bag supplied	4933402475	4002395234370
Yes	Yes	Yes	Yes	No	Yes	No kitbox or bag supplied	4933471464	4058546293635
No	Yes	Yes	No	No	Yes	No kitbox or bag supplied	4933451413	4002395161683
No	Yes	Yes	No	No	Yes	No kitbox or bag supplied	4933451414	4002395161690
No	Yes	-	Yes	Yes	Yes	No kitbox or bag supplied	4933402330	4002395234226
No	No	-	No	No	Yes	No kitbox or bag supplied	4933402325	4002395234219
No	No	-	No	No	No	No kitbox or bag supplied	4933402450	4002395234325
No	Yes	Yes	No	No	Yes	No kitbox or bag supplied	4933431820	4002395243839
No	Yes	Yes	No	No	Yes	No kitbox or bag supplied	4933431850	4002395243860
No	Yes	Yes	No	No	No	No kitbox or bag supplied	4933431860	4002395243877
No	No	No	No	No	No	No kitbox or bag supplied	4933431830	4002395243846
No	No	No	No	No	No	No kitbox or bag supplied	4933433630	4002395244423
Yes	No	Yes	-	No	Yes	No kitbox or bag supplied	4933432230	4002395243983
Yes	No	Yes	-	No	Yes	No kitbox or bag supplied	4933449850	4002395247295
Yes	No	Yes	-	No	Yes	No kitbox or bag supplied	4933455140	4002395247905
Yes	No	Yes	-	No	Yes	No kitbox or bag supplied	4933432250	4002395243990
Yes	No	Yes	-	No	Yes	No kitbox or bag supplied	4933432270	4002395244003
Yes	No	-	-	No	Yes	No kitbox or bag supplied	4933449870	4002395247912
Yes	No	-	-	No	Yes	No kitbox or bag supplied	4933428120	4002395239641
Yes	No	-	-	No	Yes	No kitbox or bag supplied	4933428127	4002395239658
Yes	No	Yes	-	No	Yes	No kitbox or bag supplied	4933433250	4002395244164
Yes	Yes	Yes	-	-	Yes	No kitbox or bag supplied	4933451218	4002395260850
Yes	No	Yes	-	-	Yes	No kitbox or bag supplied	4933464998	4058546229436
Yes	No	Yes	-	-	Yes	Kitbox	4933471194	4058546288228
Yes	No	Yes	-	-	Yes	No kitbox or bag supplied	4933451578	4002395140794
Yes	No	-	-	-	No	No kitbox or bag supplied	4933451577	4002395140787
Yes	No	Yes	-	-	Yes	No kitbox or bag supplied	4933428085	4002395239597
No	No	-	-	-	Yes	No kitbox or bag supplied	4933451222	4002395260898
No	No	-	-	-	Yes	No kitbox or bag supplied	4933451219	4002395260867
No	No	-	-	-	Yes	No kitbox or bag supplied	4933451220	4002395260874
No	No	-	-	-	Yes	No kitbox or bag supplied	4933451213	4002395260805
No	No	-	-	-	Yes	No kitbox or bag supplied	4933451210	4002395260171
No	No	-	-	-	Yes	No kitbox or bag supplied	4933451211	4002395260188
No	No	-	-	-	Yes	Kitbox	4933451281	4002395170777

AGS 15-125 C
1500 W GRINDER/SANDER



AGS 15-125 C

Article Number	4933407480
EAN Code	4002395236015

AS 12 E
1200 W SANDER WITH
ELECTRONIC VARIABLE SPEED



AS 12 E

Article Number	4933383940
EAN Code	4002395229390

AP 14-2 200 E
1450 W POLISHER



AP 14-2 200 E AP 14-2 200 E KIT

Standard equipment	Side handle, flexible backing pad	Side handle, flexible backing pad, soft & hard polishing sponge, lambswool pad, sanding & finishing compound, cloth
Article Number	4933432800	4933493427
EAN Code	4002395001156	4058546482985

AP 12 E
1200 W POLISHER WITH
ELECTRONIC VARIABLE SPEED



AP 12 E

Article Number	4933383925
EAN Code	4002395229406

DGL 34
SINGLE HIGH SPEED 2-HANDED
DIE GRINDER



DGL 34

Article Number	4933385110
EAN Code	4002395230020

DGL 30 E
VARIABLE SPEED 2-HANDED DIE
GRINDER



DGL 30 E

Article Number	4933385120
EAN Code	4002395230037

DG 30 E
VARIABLE SPEED SINGLE HANDED
DIE GRINDER



DG 30 E

Article Number	4933385100
EAN Code	4002395230013

DG 7 E
LOW SPEED DIE GRINDER



DG 7 E

Article Number	4933391200
EAN Code	4002395231928

MCS 66
DRY CUT METAL CIRCULAR SAW



MCS 66

Article Number	4933440615
EAN Code	4002395000432

BS 125
DEEP CUT BAND SAW



BS 125

Article Number	4933448245
EAN Code	4002395262830

CHS 355
2300 W CHOPSAW



CHS 355

Article Number	4933411760
EAN Code	4002395236220

DE 10 RX
630 W SINGLE HIGH SPEED
ROTARY DRILL



DE 10 RX

Article Number	4933409211
EAN Code	4002395235353

MDE 41
MAGNETIC DRILLING PRESS WITH
ELECTRO MAGNET



MDE 41

Article Number	4933451015
EAN Code	4002395136681

MDP 41
MAGNETIC DRILLING PRESS WITH
PERMANENT MAGNET



MDP 41

Article Number	4933451014
EAN Code	4002395136674

**SCAN HERE
FOR MORE
INFORMATION**



WOODWORKING

**SCAN HERE FOR
MORE INFORMATION**



SAWZALL™

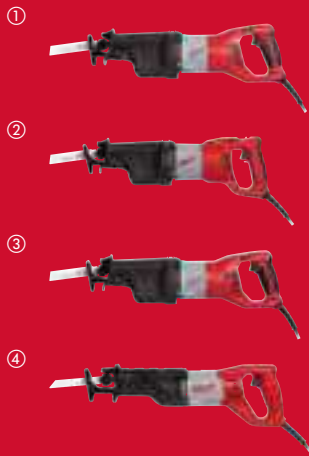

		Power input (W)	No load stroke rate (spm)	Stroke length (mm)	Weight (kg)	Supplied in	Article Number	EAN Code
1.	SSPE 1500 X	1500	0 - 2800	32	4.5	Kitbox	4933428900	4002395241699
2.	SSPE 1300 RX	1300	0 - 3000	32	4.2	Kitbox	4933440590	4002395001095
3.	SSPE 1300 SX	1300	0 - 2800	32	3.9	Kitbox	4933428520	4002395241545
4.	SSD 1100 X	1100	0 - 2900	28	3.2	Kitbox	4933416710	4002395237623

JIGSAWS

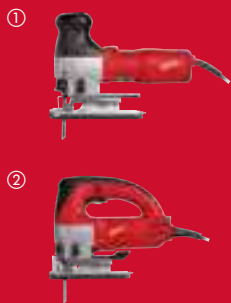

		Power input (W)	No load stroke rate (spm)	Max. cutting capacity wood/ steel/ aluminium (mm)	Mitre capacity (°)	Stroke length (mm)	Weight (kg)	Supplied in	Article Number	EAN Code
1.	FSPE 110 X	710	500 - 3000	120/ 10/ 30	45	26	2.5	Kitbox	4933357990	4002395229185
2.	JSPE 135 TX	750	800 - 3000	135/ 10/ 30	45	26	2.5	Kitbox	4933381230	4002395232529

CIRCULAR SAWS

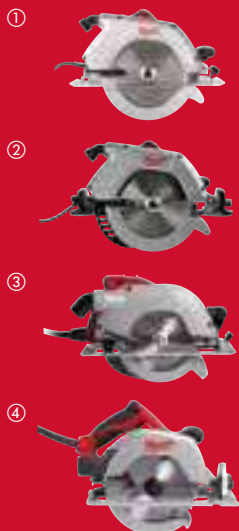

		Power input (W)	No load speed (rpm)	Blade diameter (mm)	Bevel capacity (°)	Max. cutting depth 45° (mm)	Max. cutting depth 90° (mm)	Bore size (mm)	Weight (kg)	Supplied in	Article Number	EAN Code
1.	CS 85 SB	2200	4500	235	50	67	85	30	6.6	No kitbox or bag supplied	4933451117	4002395137411
2.	CS 85 CBE	2200	4500	235	60	67	85	30	7.7	Kitbox	4933451116	4002395137404
3.	SCS 65 Q	1900	5800	190	0 - 45	52	65	30	5.5	Kitbox	638051	4002395229529
4.	CS 60	1600	5800	184	0 - 56	49	61	30	4.8	No kitbox or bag supplied	4933419225	4002395238361

SANDERS

①



		Power input (W)	No load speed (rpm)	Oscillation rate (opm)	Oscillation diameter (mm)	Sanding pad size (mm)	Weight (kg)	Supplied in	Article Number	EAN Code
1.	BS 100 LE	1150	230 - 400	-	-	100 x 160	5.3	No kitbox or bag supplied	4933385150	4002395229222

②



2.	ROS 125 E	300	7000 - 12,000	14,000 - 26,000	2.4	125	1.7	Tool bag	4933433180	4002395244010
----	-----------	-----	---------------	-----------------	-----	-----	-----	----------	------------	---------------

③



3.	SPS 140	260	14,700	28,000	1.6	113 x 105	1.6	No kitbox or bag supplied	4933447015	4002395005826
----	---------	-----	--------	--------	-----	-----------	-----	---------------------------	------------	---------------

DUST EXTRACTORS

①



		Power input (W)	Air volume (l/min)	Filter type	Max. vacuum (mbar)	Capacity (l)	Hose diameter (mm)	Hose length (m)	Weight (kg)	Supplied in	Article Number	EAN Code
1.	AS 42 MAC	1200	4500	PTFE	250	42	38	4	17.5	No kitbox or bag supplied	4933459418	4058546010799

②



2.	AS 30 MAC	1200	4500	PTFE	250	30	38	4	14.5	No kitbox or bag supplied	4933459415	4058546010768
----	-----------	------	------	------	-----	----	----	---	------	---------------------------	------------	---------------

③



3.	AS 30 LAC	1200	4500	PTFE	250	30	36	4	14.5	No kitbox or bag supplied	4933459411	4058546010720
----	-----------	------	------	------	-----	----	----	---	------	---------------------------	------------	---------------

④



4.	AS 2-250 ELCP	1000	3600	PET	210	25	32	3.5	10.4	No kitbox or bag supplied	4933447480	4002395006274
----	---------------	------	------	-----	-----	----	----	-----	------	---------------------------	------------	---------------

⑤



5.	AS 2-250EM	1200	3720	PTFE	245	25	32	4	8.0	No kitbox or bag supplied	4933493593	4058546484644
----	------------	------	------	------	-----	----	----	---	-----	---------------------------	------------	---------------

⑥



6.	AS 2-250EH	1200	3720	PTFE	245	25	32	4	8	No kitbox or bag supplied	4933493595	4058546484668
----	------------	------	------	------	-----	----	----	---	---	---------------------------	------------	---------------

RCS

REMOTE CONTROL SOCKET AND CONTROLLER KIT



RCS

Article number	4932478965
EAN code	4058546362478



RCO

REMOTE SOCKET CONTROLLER



RCO

Article Number	4932479620
EAN Code	4058546374143

MILWAUKEE® IS THE SOLUTIONS PROVIDER

ACCESSORIES



OVER
3000
SOLUTIONS

HAND TOOLS



OVER
1400
SOLUTIONS

STORAGE



OVER
180
SOLUTIONS

PPE



OVER
1000
SOLUTIONS

SYSTEM ATTACHMENTS

SYSTEM ATTACHMENTS - VIBRATORS

SYSTEM ATTACHMENTS - CONCRETE VIBRATOR WHIPS

	Description	Slabs MXF CVBP	Slabs MXF CVBC	Footings MXF CVBP	Footings MXF CVBC	Columns MXF CVBP	Columns MXF CVBC	Walls MXF CVBP	Walls MXF CVBC	Article Number	EAN Code
a.	MXF CVS-2 m Vibrator shaft 2 m	✓✓✓	✓	✓✓✓	✓	x	x	x	x	4932478611	4058546348045
b.	MXF CVS-3 m Vibrator shaft 3 m	✓✓✓	✓	✓✓✓	✓	✓	✓	✓	✓	4932479612	4058546374068
c.	MXF CVS-4 m Vibrator shaft 4 m	✓	✓✓	✓	✓✓	✓✓✓	✓✓✓	✓✓✓	✓✓✓	4932478610	4058546348038
d.	MXF CVS-6.4 m Vibrator shaft 6.4 m	x	✓✓✓	x	✓✓✓	x	✓✓✓	x	✓✓✓	4932479613	4058546374075

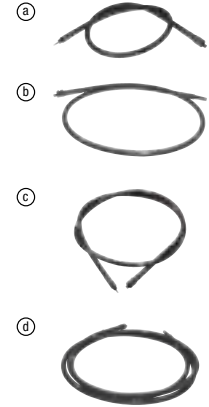

SYSTEM ATTACHMENTS - CONCRETE VIBRATOR HEADS

	Description	Diameter (mm)	Article Number	EAN Code
a.	MXF CVH-25 mm Vibrator head 25 mm	25	4932479839	4058546376338
b.	MXF CVH-38 mm Vibrator head 38 mm	38	4932478612	4058546348052
c.	MXF CVH-50 mm Vibrator head 50 mm	50	4932478613	4058546348069
d.	MXF CVH-63 mm Vibrator head 63 mm	63	4932479840	4058546376345



SYSTEM ATTACHMENTS - HIGH SPEED CONCRETE VIBRATOR

- To choose the perfect head diameter you must consider the needed radius of influence as well as the distance between the rebar
- MILWAUKEE® provides a range of different sizes to give you the perfect solution for every application

	Description	Diameter (mm)	Length (m)	Article Number	EAN Code
a.	MXF CVSHF-2/44 Vibrator shaft 2 m/ 44 mm	44	2	4932498135	4058546512958
b.	MXF CVSHF-5/44 Vibrator shaft 5 m/ 44 mm	44	5	4932498136	4058546512965
c.	MXF CVSHF-10/44 Vibrator shaft 10 m/ 44 mm	44	10	4932498137	4058546512972
d.	MXF CVSHF-2/57 Vibrator shaft 2 m/ 57 mm	57	2	4932498917	4058546527860
e.	MXF CVSHF-5/57 Vibrator shaft 5 m/ 57 mm	57	5	4932498138	4058546512989
f.	MXF CVSHF-10/57 Vibrator shaft 10 m/ 57 mm	57	10	4932498139	4058546512996

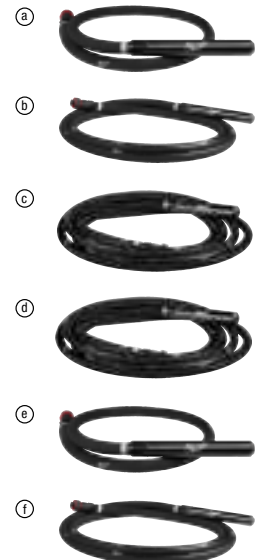

SYSTEM ATTACHMENTS - PLATE COMPACTOR

		Description	Features	Article Number	EAN Code
a.	MXF PC50 PP	Paver pad for MX FUEL™ plate compactor	<ul style="list-style-type: none"> Installation tool mounts directly onto the compactor for quick and easy access Dual direction compaction on bricks, pavers, and patio stones For use with the MX FUEL™ Plate Compactor (MXF PC50) 	4932493273	4058546481445
b.	MXF PC50 WK	Wheel kit for MX FUEL™ plate compactor	<ul style="list-style-type: none"> Wheel kit for easy maneuverability For use with the MX FUEL™ Plate Compactor (MXF PC50) 	4932493274	4058546481452
c.	MXF PC50 WT	Water tank for MX FUEL™ plate compactor	<ul style="list-style-type: none"> 13 litre water tank with quick-release attachment Adjustable flow rate dial for easy control and optimised water flow For use with the MX FUEL™ Plate Compactor (MXF PC50) 	4932498924	4058546527938



SYSTEM ATTACHMENTS - SCREED

- Our screed blades have an extra rigid, double triangle design to transmit consistent vibrations across the length of the bar, with minimal variability
- Constructed from lightweight magnesium to reduce the weight of the screed
- The screed blade utilises a clamp design with no holes through the bar, allowing you to quickly attach the blade at any point on the machine
- Blade lengths from 1.22 m up to 4.87 m
- Compatible with the MX FUEL™ Screed

		Description	Length (m)	Weight (kg)	Article Number	EAN Code
a.	MXF PSB-1.22m	Screed blade for MX FUEL™ screed (MXF PSC) - 1.22 m	1.22	3.6	4932479776	4058546375706
b.	MXF PSB-1.83m	Screed blade for MX FUEL™ screed (MXF PSC) - 1.83 m	1.83	5.5	4932479777	4058546375713
c.	MXF PSB-2.44m	Screed blade for MX FUEL™ screed (MXF PSC) - 2.44 m	2.44	7.3	4932479778	4058546375720
d.	MXF PSB-3.00m	Screed blade for MX FUEL™ screed (MXF PSC) - 3.0 m	3.00	9.1	4932479779	4058546375737
e.	MXF PSB-3.65m	Screed blade for MX FUEL™ screed (MXF PSC) - 3.65 m	3.65	10.9	4932479780	4058546375744
f.	MXF PSB-4.25m	Screed blade for MX FUEL™ screed (MXF PSC) - 4.25 m	4.25	12.8	4932479781	4058546375751
g.	MXF PSB-4.87m	Screed blade for MX FUEL™ screed (MXF PSC) - 4.87 m	4.87	14.6	4932479782	4058546375768
h.	MXF PSCA	MX FUEL™ screed bar adapter to L-shape	-	-	4932499258	4058546564223

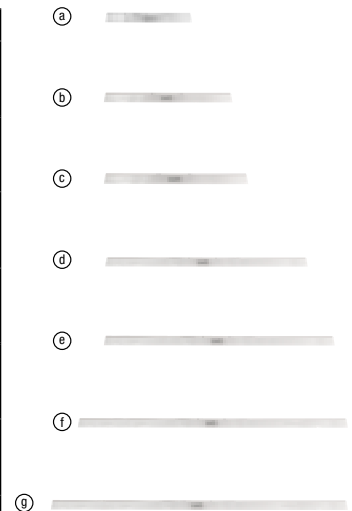

SYSTEM ATTACHMENTS - TROWEL

		Description	Fits Milwaukee trowel	Article Number	EAN Code
a.	MXF WBT60P	Pan for MX FUEL™ 600 mm walk behind edging trowel	MXF WBT60	4932498919	4058546527884
b.	MXF WBT60CB	4 pc blade set for MX FUEL™ 600 mm walk behind edging trowel	MXF WBT60	4932498918	4058546527877
c.	MXF WBT90P	Pan for MX FUEL™ 900 mm walk behind power trowel	MXF WBT90	4932498921	4058546527907
d.	MXF WBT90CB	4pc blade set for MX FUEL™ 900 mm walk behind power trowel	MXF WBT90	4932498920	4058546527891
e.	MXF WBT90FIB	4 pc finish blade set for MX FUEL™ 900 mm walk behind power trowel	MXF WBT90	4932498923	4058546527921
f.	MXF WBT90FLB	4 pc float blades for MX FUEL™ 900 mm walk behind power trowel	MXF WBT90	4932498922	4058546527914



SYSTEM ATTACHMENTS - PIPE THREADER

	Description	Features	Article Number	EAN Code	
a.	Reamer cone for MX FUEL™ pipe threading machine 2" with ONE-KEY™	Reamer cone for MX FUEL™ pipe threading machine 2" with ONE-KEY™	◦ Replacement cone for the MX FUEL™ pipe threading machine 2" with ONE-KEY™ ◦ Durable metal construction ◦ Removes inner pipe burs ◦ Easy replacement process	49165105	045242833634
b.	Pipe cutter wheel for MX FUEL™ pipe threading machine 2" with ONE-KEY™	Pipe cutter wheel for MX FUEL™ pipe threading machine 2" with ONE-KEY™	◦ Black oxide coated ◦ For use in black iron pipe, rigid metal conduit, galvanized steel, and stainless steel ◦ 55Si2Mn steel ◦ One pack contains 4x cutter wheels	48361401	045242745920
c.	Threading jaw inserts for MXF PTR2	Threading jaw inserts for PVC coated pipes	◦ Standard threading jaws for steel pipes ◦ Special threading jaws for PVC coated pipes ◦ Jaw inserts are sold in packages of 6 for replacement of all inserts in the front and backside hammer chuck	49165102	045242771288
d.		Threading jaw inserts for pipes	49165104	045242833627	
e.	Pipe theader adapter kit for Ridgid 11-R	Pipe theader adapter kit for Ridgid	◦ Adapter kit for M18 FPT2, pipe threader ◦ Small adapter for sizes 1/8" up to 1-1/4" ◦ Large adapter for 1-1/2" up to 2"	4932478838	4058546361204
f.	Pipe theader adapter kit for REMS	Pipe theader adapter kit for REMS	◦ Adapter kit for M18 FPT2, pipe threader ◦ Small adapter for sizes 1/8" up to 1-1/4" ◦ Large adapter for 1-1/2" up to 2"	4932478839	4058546361211
g.	Pipe theader adapter kit for Rothenberger	Pipe theader adapter kit for Rothenberger	◦ Adapter kit for M18 FPT2, pipe threader ◦ Small adapter for sizes 1/8" up to 1-1/4" ◦ Large adapter for 1-1/2" up to 2"	4932478840	4058546361228
h.	Pipe threader oil	Mineral threading oil, 5 litre	◦ 5l Canister of threading oil for use with the MX FUEL™ Pipe Threading Machine ◦ Ideal cooling performance ensuring high quality threads ◦ Mineral Based oil not for use on drink water lines	4932493462	4058546483333
i.		Synthetic threading oil, 5 litre	4932493463	4058546483340	

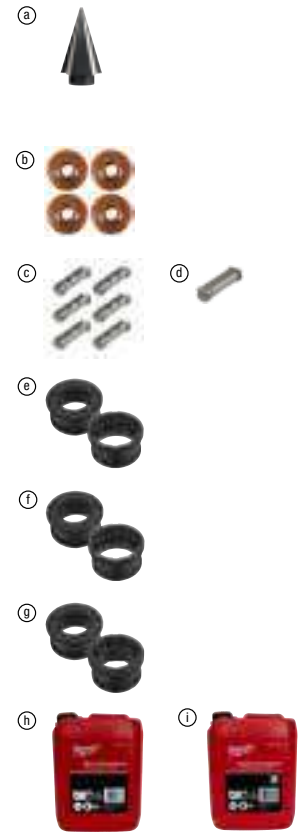

SYSTEM ATTACHMENTS - PIPE THREADER DIES

- High performance threader dies ensure perfect threads and long lasting performance in combination with the MILWAUKEE® threaders
- Dies are available in two types of thread geometries: BSPT (British Standard Pipe Taper) and NPT (National Taper Pipe)
- Dies are available in two different grades: Alloy dies for long lasting performance on black and galvanised pipes and HS dies for best performance on stainless steel pipes
- One set contains 4 single cutting dies that are needed to equip one die head

	Type	Thread size (inch)	Fits Milwaukee pipe threader	Article Number	EAN Code	
a.	FPTD 1/2" NPT HS	NPT HS	1/2	M18 FPT114, M18 FPT2	48361107	045242608713
	FPTD 3/4" NPT HS	NPT HS	3/4	M18 FPT114, M18 FPT2	48361108	045242608720
	FPTD 1" NPT HS	NPT HS	1	M18 FPT114, M18 FPT2	48361109	045242608737
	FPTD 1 1/4" NPT HS	NPT HS	1 - 1/4	M18 FPT114, M18 FPT2	48361110	045242608744
	FPTD 1 1/2" NPT HS	NPT HS	1 - 1/2	M18 FPT114, M18 FPT2	48361111	045242608751
	FPTD 2" NPT HS	NPT HS	2	M18 FPT114, M18 FPT2	48361112	045242608768
b.	FPTD 1/2" BSPT Alloy	BSPT Alloy	1/2	M18 FPT114, M18 FPT2	4932480227	4058546405120
	FPTD 3/4" BSPT Alloy	BSPT Alloy	3/4	M18 FPT114, M18 FPT2	4932480228	4058546405137
	FPTD 1" BSPT Alloy	BSPT Alloy	1	M18 FPT114, M18 FPT2	4932480229	4058546405144
	FPTD 1 1/4" BSPT Alloy	BSPT Alloy	1 - 1/4	M18 FPT114, M18 FPT2	4932480230	4058546405151
	FPTD 1 1/2" BSPT Alloy	BSPT Alloy	1 - 1/2	M18 FPT114, M18 FPT2	4932480231	4058546405168
	FPTD 2" BSPT Alloy	BSPT Alloy	2	M18 FPT114, M18 FPT2	4932480232	4058546405175
c.	FPTD 1/2" BSPT HS	BSPT HS	1/2	M18 FPT114, M18 FPT2	4932480233	4058546405182
	FPTD 3/4" BSPT HS	BSPT HS	3/4	M18 FPT114, M18 FPT2	4932480234	4058546405199
	FPTD 1" BSPT HS	BSPT HS	1	M18 FPT114, M18 FPT2	4932480235	4058546405205
	FPTD 1 1/4" BSPT HS	BSPT HS	1 - 1/4	M18 FPT114, M18 FPT2	4932480236	4058546405212
	FPTD 1 1/2" BSPT HS	BSPT HS	1 - 1/2	M18 FPT114, M18 FPT2	4932480237	4058546405229
	FPTD 2" BSPT HS	BSPT HS	2	M18 FPT114, M18 FPT2	4932480238	4058546405236
d.	PTR2D 1/2" - 3/4" NPT HSS	NPT HSS	1/2 - 3/4	MXF PTR2	48361205	045242745876
	PTR2D 1" - 2" NPT HSS	NPT HSS	1 - 2	MXF PTR2	48361206	045242745906
e.	PTR2D 1/2" - 3/4" BSPT Alloy	BSPT Alloy	1/2 - 3/4	MXF PTR2	4932492924	4058546477950
	PTR2D 1" - 2" BSPT Alloy	BSPT Alloy	1 - 2	MXF PTR2	4932492925	4058546477967
f.	PTR2D 1/2" - 3/4" BSPT HS	BSPT HS	1/2 - 3/4	MXF PTR2	4932492926	4058546477974
	PTR2D 1" - 2" BSPT HS	BSPT HS	1 - 2	MXF PTR2	4932492927	4058546477981
g.	PTR2D 1/2" - 3/4" BSPT HSS	BSPT HSS	1/2 - 3/4	MXF PTR2	4932492928	4058546477998
	PTR2D 1" - 2" BSPT HSS	BSPT HSS	1 - 2	MXF PTR2	4932492929	4058546478001

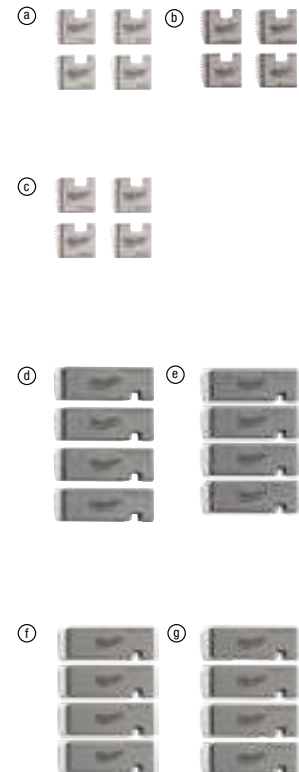

SYSTEM ATTACHMENTS - PIPE THREADER DIE HEADS

- Up to 50% lighter than competitive die heads
- Available sizes from 1/2" up to 2"
- Die heads always include a set of BSPT alloy dies

		Description	Fits Milwaukee pipe threader	Thread size (inch)	Type	Article Number	EAN Code
a.	FPT2H 1/2" BSPT Alloy	FPT2H 1/2" BSPT Alloy	M18 FPT2	1/2	BSPT Alloy	4932480239	4058546405243
	FPT2H 3/4" BSPT Alloy	FPT2H 3/4" BSPT Alloy	M18 FPT2	3/4	BSPT Alloy	4932480240	4058546405250
	FPT2H 1" BSPT Alloy	FPT2H 1" BSPT Alloy	M18 FPT2	1	BSPT Alloy	4932480241	4058546405267
	FPT2H 1-1/4" BSPT Alloy	FPT2H 1 1/4" BSPT Alloy	M18 FPT2	1 1/4	BSPT Alloy	4932480242	4058546405274
	FPT2H 1-1/2" BSPT Alloy	FPT2H 1 1/2" BSPT Alloy	M18 FPT2	1 1/2	BSPT Alloy	4932480243	4058546405281
	FPT2H 2" BSPT Alloy	FPT2H 2" BSPT Alloy	M18 FPT2	2	BSPT Alloy	4932480244	4058546405298
	b.	FPT114H 1/2" BSPT Alloy	FPT2H 1/2" BSPT Alloy	M18 FPT114	1/2	BSPT Alloy	4932480245
FPT114H 3/4" BSPT Alloy		FPT2H 1/2" BSPT Alloy	M18 FPT114	3/4	BSPT Alloy	4932480246	4058546405311
FPT114H 1" BSPT Alloy		FPT2H 1/2" BSPT Alloy	M18 FPT114	1	BSPT Alloy	4932480247	4058546405328
FPT114H 1-1/4" BSPT Alloy		FPT2H 1/2" BSPT Alloy	M18 FPT114	1 1/4	BSPT Alloy	4932480248	4058546405335
c.	FPT2HK BSPT Alloy	FPT2HK BSPT alloy PACKOUT™ head kit (6pc)	M18 FPT2	1/2", 3/4", 1", 1 1/4", 1 1/2", 2"	BSPT Alloy	4932480249	4058546405342
d.	FPT114HK BSPT Alloy	FPT114HK BSPT alloy PACKOUT™ head kit (4pc)	M18 FPT114	1/2", 3/4", 1", 1 1/4"	BSPT Alloy	4932480250	4058546405359
e.	PTR2 DH NPT	NPT die head for MX FUEL™ pipe threading machine 2"	MXF PTR2	1/2"-2"	NPT	49165100	045242771264
	PTR2 DH BSPT	BSPT die head for MX FUEL™ pipe threading machine 2"	MXF PTR2	1/2"-2"	BSPT	49165103	045242810109

Ⓐ



Ⓑ



Ⓓ



Ⓔ



SYSTEM ATTACHMENTS - MAGNETIC DRILL STANDS



4932604226

MDE/P 41 M18™ FMDP-502 C **MD 38** **MDE 42/MBE 1200 Reception 1/2" x 20 UNF** **MDE 4-85 Reception Morse taper 3** **Ejector tool for Morse taper**



49590020

Arbor and chuck



Metal drill bits



1/2" x 20
48662125

Arbor and chuck
13 mm



Metal drill bits



1/2" x 20 UNF
4932267980

Keyed chuck
1.5–13 mm



4932371785

Oil feed ring



1/2" x 20 UNF
19 mm Weldon
4932372781

Cutter arbor
(standard equipment)



4932371782

Oil cup assembly



4932371788

Oil feed arbor

19 mm Weldon



30 mm
Cutters (Short)

49590011

Telescopic ejector pin
(30 mm)



19 mm Weldon
4932343310

Cutter arbor
(standard equipment)

19 mm Weldon



50 mm
Cutters (Long)

49590012

Telescopic ejector pin
(50 mm)



MT 3
19 mm Weldon
4932343310

Cutter arbor
(standard equipment)



MT 3
B 16
4932117042

Chuck adaptor



4932127010

Keyed chuck
3–16 mm



Metal
drill bits

SYSTEM ATTACHMENTS - WET DIAMOND DRILLING













	Description	Fits DD3-152	Fits DCM2-250C & DCM2-350C	Fits MXF DCD150	Fits MXF DCD350	Article Number	EAN Code
a	Fixing kit	✓	✓	✓	✓	4932399731	4002395363827
	1 3/8" open ended spanner. For holding the motor output spindle while removing a core bit		✓			49964705	04524222766
	32 mm ended spanner. For holding the motor output spindle while removing a core bit.	✓				4931428009	4002395844791
	41 mm open ended spanner. For removing the core bit from the motor spindle.	✓	✓		✓	4931428010	4002395844807
b	Fixtec release. Suitable for all diamond motors with 1 1/4" spindle reception. Prevents the core bit from locking itself too tight onto the machine spindle. The core bits can then be released and removed with minimum effort	✓	✓			4932352053	4002395367108
	1 1/4" female to 1/2" female adaptor. To enable the connection of <50 mm diamond core bits on a 1 1/4" machine spindle thread	✓	✓		✓	4932352627	4002395372850
c	1 1/4" female / male extension rod, length 300 mm	✓	✓	✓	✓	4932399724	4002395363759
	1 1/4" female / male extension rod, length 500 mm	✓	✓	✓	✓	4932399725	4002395363766
d	Telescopic extension. Extension pole used to fix drill rig to the ground instead of anchor bolts. Maximum load of 500 kg and adjustable extension height from 1.8-2.9 m	✓	✓	✓		4932399732	4002395363834
e	Vacuum pump VP6	✓	✓	✓	✓	4932352094	4002395367474
f	Vacuum plate. Replacement rubber seal 4931428665	✓				4932352676	4002395373345
g	WT 10 watertank	✓	✓	✓	✓	4932399726	4002395363773
h	Water collection ring: For use with drill rig DR 152 T. For use with max. Ø 152 mm core bits					4932352677	4002395373352
	Replacement rubber ring for DR 152 T					4932352678	4002395373369
i	Water collection ring: max. Ø 180 mm			✓		4932399727	4002395363780
	Replacement rubber ring for DR 250 TV			✓		4932399729	4002395363803
i	Water collection ring: For use with drill rig DR 350 T. For use with max. Ø 300 mm core bits					4932399728	4002395363797
	Replacement rubber ring for DR 350 T					4932399730	4002395363810
j	Spacer block T = 50 mm. Needs to be mouted between drill rig and motor cores > 250 mm and max. 350 mm. Included in drill rig DR 350 T		✓			4932399736	4002395363872
k	Quick connection motor mounting plate. Included in both drill rigs DR 250 TV and DR 350 T		✓			4932399733	4002395363841
	Water collection ring: For universal use with diamond drilling tools. For use with max. Ø 152 mm core bits	✓	✓	✓	✓	4932478073	4058546340063



SYSTEM ATTACHMENTS - DRAIN CLEANERS

	Description	Fits drain cleaners M12BDC6, M12 BDC8	Fits drain cleaners M18 FDCPF8, M18 FDCPF10	Fits drain cleaners M18 FFSDC16, M18 FFSDC13, M18 FFSDC10	Fits drain cleaners MXF LSDP	Article Number	EAN Code	
Open wind spiral SD	16 mm x 15.2 m open wind coupling end			✓		48532775	045242513109	
Tight wind spiral HH	6 mm x 7.6 m inner core bulb head	✓				48532573	045242471270	
	8 mm x 7.6 m inner core drop head	✓				48532572	045242364206	
	6 mm x 7.6 m inner core drop head	✓				48532574	045242471287	
	6 mm x 10.6 m inner core bulb head		✓			48532671	045242482740	
	6 mm x 15.2 m inner core bulb head		✓			48532672	045242482757	
	8 mm x 7.6 m inner core bulb head	✓				48532571	045242364213	
	8 mm x 10.6 m inner core bulb head		✓			48532673	045242482764	
	8 mm x 15.2 m inner core bulb head		✓			48532674	045242482771	
	10 mm x 10.6 m inner core coupling end		✓			48532675	045242482788	
	8 mm x 7.6 m inner core bulb head drum	✓				48532581	045242480586	
	8 mm x 7.6 m inner core drop head drum	✓				48532582	045242480593	
	6 mm x 7.6 m inner core bulb head drum	✓				48532583	045242480609	
	6 mm x 7.6 m inner core drop head drum	✓				48532584	045242480616	
Tight wind spiral SD	8 mm x 23 m inner core bulb head			✓		48532772	045242513079	
	10 mm x 15.2 m inner core coupling end			✓		48532773	045242513086	
	13 mm x 15.2 m inner core coupling end			✓		48532774	045242513093	
	16 mm x 7.6 m inner core coupling end				✓	4932471701	4058546296001	
	16 mm x 15.2 m inner core coupling end				✓	4932471702	4058546296018	
	20 mm x 7.6 m inner core coupling end				✓	4932471703	4058546296025	
	20 mm x 15.2 m inner core coupling end				✓	4932471704	4058546296032	
	16 mm anchor cable coupling end				✓	4932471707	4058546296063	
	16 mm x 60 cm leader cable coupling end				✓	4932471708	4058546296070	
	20 mm x 600 mm leader cable coupling end				✓	4932471709	4058546296087	
Bulb auger HH	Small bulb auger for 10, 13, 16 mm cables		✓	✓		48532681	045242503803	
C-cutter HH	Small C cutter for 10, 13, 16 mm cables		✓	✓		48532684	045242503834	
C-cutter SD	Medium C cutter for 10, 13, 16 mm cables		✓	✓		48532789	045242006137	
Chain knocker SD	75 mm chain knocker for 16, 20 mm cables				✓	48532837	4058546323448	
	100 mm chain knocker for 16, 20 mm cables				✓	48532838	4058546323455	
Drop head HH	Small drop head for 10, 13, 16 mm cables		✓	✓		48532682	045242503810	
Drop head SD	Medium drop head for 10, 13, 16 mm cables		✓	✓		48532787	045242006113	
Funnel auger SD	Funnel auger for 16, 20 mm cables				✓	48532831	4058546323387	
	Medium funnel auger for 10, 13, 16 mm cables		✓	✓		48532786	045242006106	
Head kit HH	Small 5 pc head kit for 10, 13, 16 mm cables		✓	✓		48532685	045242503841	
Head kit SD	Medium 5 pc head kit for 10, 13, 16 mm cables		✓	✓		48532790	045242006144	
	9 pc head kit 16, 20 mm cables				✓	48532840	4058546296131	
Opening tool SD	Small opening tool for 16, 20 mm cables				✓	48532835	4058546323424	
	Medium opening tool for 16, 20 mm cables				✓	48532836	4058546323431	
Root cutter SD	75 mm root cutter for 16, 20 mm cables				✓	48532832	4058546323394	
	100 mm root cutter for 16, 20 mm cables				✓	48532833	4058546323400	
	150 mm root cutter for 16, 20 mm cables				✓	48532834	4058546323417	
Spade bit HH	Small spade bit for 10, 13, 16 mm cables		✓	✓		48532683	045242503827	
Spade bit SD	Medium spade bit for 10, 13, 16 mm cables		✓	✓		48532788	045242006120	
Straight auger SD	Straight auger for 16, 20 mm cables				✓	48532830	4058546323370	
SWITCH PACK™ autofeed	SWITCH PACK™ auto feed for M18 FFSDC series			✓		4932471993	4058546298920	
SWITCH PACK™ guidehose	Guide hose for SWITCH PACK™ auto feed			✓		4932471994	4058546298937	
SWITCH PACK™ base plate autofeed	Base plate for SWITCH PACK™ auto feed			✓		4932478225	4058546344023	
SWITCH PACK™ drum	SWITCH PACK™ drum for M18 FFSDC series			✓		4932464277	4058546222222	
MX drum guide hose	Guide hose for MXFLSDP				✓	4932478110	4058546340421	
Pin key	Pin key for all cables		✓	✓	✓	4932471717	4058546296162	

SYSTEM ATTACHMENTS - SECTIONAL SEWER MACHINES

	Description	Fits sewer machine M18 FCSSM	Fits sewer machine M18 FSSM	Article Number	EAN Code	
Open wind spiral SM	16 mm x 2.3 m open wind coupling end	✓		4932478413	4058546346041	
	16 mm x 2.3 m open wind inner core coupling	✓		4932478414	4058546346058	
	22 mm x 4.5 m open wind inner core coupling end	✓	✓	4932478415	4058546346065	
	22 mm x 4.5 m open wind coupling end	✓	✓	4932471712	4058546296117	
	22 mm x 4.5 m open wind coupling end kit	✓	✓	4932471713	4058546296124	
	32 mm x 4.5 m open wind coupling end		✓	4932471710	4058546296094	
	32 mm x 4.5 m open wind heavy duty coupling end		✓	4932471711	4058546296100	
Drop head SM	Drop head bulb 16 mm cables	✓		48533811	4058546346133	
	Drop head straight 16 mm cables	✓		48533812	4058546346126	
Funnel auger SM	Funnel auger for 16 mm cables	✓		48533813	4058546346140	
	Small funnel auger for 22 mm cables	✓	✓	48533828	4058546346089	
	Medium funnel auger for 22 mm cables	✓	✓	48533831	4058546323479	
	Funnel auger for 32 mm cables		✓	48534831	4058546323561	
Opening tool SM	Extra small opening tool for 16 mm cables	✓		48533814	4058546346157	
	Small opening tool for 16 mm cables	✓		48533815	4058546346164	
	Small opening tool for 22 mm cables	✓	✓	48533827	4058546346096	
	Small opening tool for 22 mm cables	✓	✓	48533835	4058546323516	
	Medium opening tool for 22 mm cables	✓	✓	48533836	4058546323523	
	Small opening tool for 32 mm cables		✓	48534835	4058546323608	
	Medium opening tool for 32 mm cables		✓	48534836	4058546323615	
Spring cleaner SM	Spring cleaner for 16 mm cables	✓		48533816	4058546346171	
	Spring cleaner for 22 mm cables	✓	✓	48533826	4058546346102	
Root cutter SM	50 mm root cutter for 22 mm cables	✓	✓	48533825	4058546346119	
	75 mm root cutter for 22 mm cables	✓	✓	48533832	4058546323486	
	100 mm root cutter for 22 mm cables	✓	✓	48533833	4058546323493	
	150 mm root cutter for 22 mm cables	✓	✓	48533834	4058546323509	
	75mm root cutter for 32 mm cables		✓	48534832	4058546323578	
	100 mm root cutter for 32 mm cables		✓	48534833	4058546323585	
	150 mm root cutter for 32 mm cables		✓	48534834	4058546323592	
Straight auger SM	Small straight auger for 22 mm cables	✓	✓	48533829	4058546346072	
	Medium straight auger for 22 mm cables	✓	✓	48533830	4058546323462	
	Straight auger for 32 mm cables		✓	48534830	4058546323554	
Chain knocker SM	75 mm chain knocker for 22 mm spirals	✓	✓	48533837	4058546323530	
	100 mm chain knocker 22 mm cables	✓	✓	48533838	4058546323547	
	75 mm chain knocker for 32 mm spirals		✓	48534837	4058546323622	
	100 mm chain knocker 32 mm cables		✓	48534838	4058546323639	
Head kit SM	9pc head kit for 22 mm cables	✓	✓	48533840	4058546296148	
	9pc head kit for 32 mm cables		✓	48534839	4058546296155	
Small guide hose	Small guide hose for FCSSM	✓		4932478410	4058546346010	
Medium guide hose	Medium guide hose for FCSSM	✓		4932478409	4058546346003	
Large guide hose	Large guide hose for FSSM		✓	4932471720	4058546296193	
Cable drum	Cable drum for 16mm spirals	✓		4932478412	4058546346034	
	Cable drum for 22mm spirals	✓	✓	4932478411	4058546346027	
	Cable drum for 32mm spirals		✓	4932471719	4058546296186	
Pin key	Pin key for all cables	✓	✓	4932471717	4058546296162	

SYSTEM ATTACHMENTS - PRESS JAWS

	Jaw profile	Fits to following pipe system suppliers	Fits Milwaukee Press tool	Nominal size	Tool suitability	Description	Requires	Article Number	EAN Code
a.			M12 HPT, M12 ONEHPT	12	M12	J12-M12	-	4932430243	4002395379040
			M12 HPT, M12 ONEHPT	15	M12	J12-M15	-	4932430245	4002395379064
			M12 HPT, M12 ONEHPT	18	M12	J12-M18	-	4932430247	4002395379088
			M12 HPT, M12 ONEHPT	22	M12	J12-M22	-	4932430249	4002395379101
			M12 HPT, M12 ONEHPT	28	M12	J12-M28	-	4932430251	4002395379125
b.	M	Geberit: Mapress VSH: X-Press Eurotubi Raccorderie Metallique Rubinetteria Bresciane Sanha: Niroshan Pegler Yorkshire	M12 HPT, M12 ONEHPT	35	M12	J12-M35	-	4932430253	4002395379149
			M18 HPT, M18 BLHPT	12	M18	J18-M12	-	4932430244	4002395379057
			M18 HPT, M18 BLHPT	15	M18	J18-M15	-	4932430246	4002395379071
			M18 HPT, M18 BLHPT	18	M18	J18-M18	-	4932430248	4002395379095
			M18 HPT, M18 BLHPT	22	M18	J18-M22	-	4932430250	4002395379118
			M18 HPT, M18 BLHPT	28	M18	J18-M28	-	4932430252	4002395379132
			M12 HPT	35	M18	J18-M35	-	4932430254	4002395379156
			M18 HPT, M18 BLHPT	42	M18	RJ18-M42	RJA-1	4932430255	4002395379163
			M18 HPT, M18 BLHPT	54	M18	RJ18-M54	RJA-1	4932430256	4002395379170
			M18 HPT, M18 BLHPT	-	-	-	RJA-1	4932430307	4002395379682
c.			M18 BLHPTXL	76.1	M18	RJ18XL-M76.1	RJAXL-1	4932479458	4058546372521
			M18 BLHPTXL	88.9	M18	RJ18XL-M88.9	RJAXL-1	4932479459	4058546372538
			M18 BLHPTXL	108	M18	RJ18XL-M108	RJAXL-1 & RJAXL-2	4932479460	4058546372545
			M18 BLHPTXL	-	M18	RJAXL-1	-	4932479451	4058546372453
			M18 BLHPTXL	-	M18	RJAXL-2	-	4932479452	4058546372460



	Jaw profile	Fits to following pipe system suppliers	Fits Milwaukee Press tool	Nominal size	Tool suitability	Description	Requires	Article Number	EAN Code			
a.			M12 HPT, M12 ONEHPT	12	M12	J12-V12	-	4932430260	4002395379217			
			M12 HPT, M12 ONEHPT	14	M12	J12-V14	-	4932451660	4002395273423			
			M12 HPT, M12 ONEHPT	15	M12	J12-V15	-	4932430262	4002395379231			
			M12 HPT, M12 ONEHPT	16	M12	J12-V16	-	4932451661	4002395273430			
			M12 HPT, M12 ONEHPT	18	M12	J12-V18	-	4932430264	4002395379255			
			M12 HPT, M12 ONEHPT	22	M12	J12-V22	-	4932430266	4002395379279			
			M12 HPT, M12 ONEHPT	28	M12	J12-V28	-	4932430268	4002395379293			
			M12 HPT, M12 ONEHPT	35	M12	J12-V35	-	4932430270	4002395379316			
			b.	V	Viega Comap IBP Sanha: Niroshan	M18 HPT, M18 BLHPT	12	M18	J18-V12	-	4932430261	4002395379224
						M18 HPT, M18 BLHPT	14	M18	J18-V14	-	4932471086	4058546287146
M18 HPT, M18 BLHPT	15	M18				J18-V15	-	4932430263	4002395379248			
M18 HPT, M18 BLHPT	16	M18				J18-V16	-	4932471087	4058546287153			
M18 HPT, M18 BLHPT	18	M18				J18-V18	-	4932430265	4002395379262			
M18 HPT, M18 BLHPT	22	M18				J18-V22	-	4932430267	4002395379286			
M18 HPT, M18 BLHPT	28	M18				J18-V28	-	4932430269	4002395379309			
M18 HPT, M18 BLHPT	35	M18				J18-V35	-	4932430271	4002395379323			
M18 HPT, M18 BLHPT	42	M18				RJ18-V42	RJA-1	4932430272	4002395379330			
M18 HPT, M18 BLHPT	54	M18				RJ18-V54	RJA-1	4932430273	4002395379347			
			M18 HPT, M18 BLHPT	-	M18	RJA-1	-	4932430307	4002395379682			
			M18 BLHPT, M18 ONEBLHPT	76.1	M18	RJ18-V76.1	RJAV-2	4932479455	4058546372491			
			M18 BLHPT, M18 ONEBLHPT	88.9	M18	RJ18-V88.9	RJAV-2	4932479456	4058546372507			
			M18 BLHPT, M18 ONEBLHPT	108	M18	RJ18-V108	RJAV-2	4932479457	4058546372514			
			M18 BLHPT, M18 ONEBLHPT	-	M18	RJAV-2	-	4932479604	4058546373986			



	Jaw profile	Fits to following pipe system suppliers	Fits Milwaukee Press tool	Nominal size	Tool suitability	Description	Requires	Article Number	EAN Code
a.			M12 HPT, M12 ONEHPT	14	M12	J12-U14	-	4932430291	4002395379521
			M12 HPT, M12 ONEHPT	16	M12	J12-U16	-	4932430293	4002395379545
			M12 HPT, M12 ONEHPT	18	M12	J12-U18	-	4932430295	4002395379569
			M12 HPT, M12 ONEHPT	20	M12	J12-U20	-	4932430297	4002395379583
			M12 HPT, M12 ONEHPT	25	M12	J12-U25	-	4932430299	4002395379606
b.	U	ALB Uponor: Unipipe, Airpipe Kan: Kan-therm Wavin: Press-Systeme Frankische: AlpeX F50 Profi DW Verbundrohr Multitubo IBP:>B<Flex KE Kelit: Kelit Kelox Jupiter: Heizsystem	M12 HPT, M12 ONEHPT	32	M12	J12-U32	-	4932430301	4002395379620
			M12 HPT, M12 ONEHPT	40	M12	J12-U40	-	4932430303	4002395379644
			M18 HPT, M18 BLHPT	14	M18	J18-U14	-	4932430292	4002395379538
			M18 HPT, M18 BLHPT	16	M18	J18-U16	-	4932430294	4002395379552
			M18 HPT, M18 BLHPT	18	M18	J18-U18	-	4932430296	4002395379576
			M18 HPT, M18 BLHPT	20	M18	J18-U20	-	4932430298	4002395379590
			M18 HPT, M18 BLHPT	25	M18	J18-U25	-	4932430300	4002395379613
			M18 HPT, M18 BLHPT	32	M18	J18-U32	-	4932430302	4002395379637
			M18 HPT, M18 BLHPT	40	M18	RJ18-U40	RJA-1	4932430304	4002395379651
			M18 HPT, M18 BLHPT	50	M18	RJ18-U50	RJA-1	4932430305	4002395379668
			M18 HPT, M18 BLHPT	63	M18	RJ18-U63	RJA-1	4932430306	4002395379675
			M18 HPT, M18 BLHPT	-	M18	RJA-1	-	4932430307	4002395379682



Jaw profile	Fits to following pipe system suppliers	Fits Milwaukee Press tool	Nominal size	Tool suitability	Description	Requires	Article Number	EAN Code	
a.	G	Geberit: Mepla & Mepla Therm	M12 HPT, M12 ONEHPT	16	M12	J12-G16	-	4932464217	4058546221621
			M12 HPT, M12 ONEHPT	20	M12	J12-G20	-	4932464218	4058546221638
			M12 HPT, M12 ONEHPT	26	M12	J12-G26	-	4932464219	4058546221645
			M12 HPT, M12 ONEHPT	32	M12	J12-G32	-	4932464220	4058546221652
			M12 HPT, M12 ONEHPT	40	M12	J12-G40	-	4932464221	4058546221669
b.			M18 HPT, M18 BLHPT	16	M18	J18-G16	-	4932464544	4058546224899
			M18 HPT, M18 BLHPT	20	M18	J18-G20	-	4932464545	4058546224905
			M18 HPT, M18 BLHPT	26	M18	J18-G26	-	4932464546	4058546224912
			M18 HPT, M18 BLHPT	32	M18	J18-G32	-	4932464547	4058546224929
			M18 HPT, M18 BLHPT	40	M18	J18-G40	-	4932464548	4058546224936
		M18 HPT, M18 BLHPT	50	M18	J18-G50	-	4932464549	4058546224943	



Jaw profile	Fits to following pipe system suppliers	Fits Milwaukee Press tool	Nominal size	Tool suitability	Description	Requires	Article Number	EAN Code		
a.	ALB Comap Frankische Henco (nur TH14 - TH25) IPA Sanha Tiemme		M12 HPT, M12 ONEHPT	14	M12	J12-TH14	-	4932430274	4002395379354	
			M12 HPT, M12 ONEHPT	16	M12	J12-TH16	-	4932430276	4002395379378	
			M12 HPT, M12 ONEHPT	18	M12	J12-TH18	-	4932430278	4002395379392	
			M12 HPT, M12 ONEHPT	20	M12	J12-TH20	-	4932430280	4002395379415	
			M12 HPT, M12 ONEHPT	25	M12	J12-TH25	-	4932430282	4002395379439	
			M12 HPT, M12 ONEHPT	26	M12	J12-TH26	-	4932430283	4002395379446	
			M12 HPT, M12 ONEHPT	32	M12	J12-TH32	-	4932430285	4002395379460	
			M12 HPT, M12 ONEHPT	40	M12	J12-TH40	-	4932430287	4002395379484	
			b.	M18 HPT, M18 BLHPT	14	M18	J18-TH14	-	4932430275	4002395379361
				M18 HPT, M18 BLHPT	16	M18	J18-TH16	-	4932430277	4002395379385
M18 HPT, M18 BLHPT				18	M18	J18-TH18	-	4932430279	4002395379408	
M18 BLHPT, M18 HPT				20	M18	J18-TH20	-	4932430281	4002395379422	
M18 HPT, M18 BLHPT				25	M18	J18-TH25	-	4932430355	4002395380169	
M18 HPT, M18 BLHPT				26	M18	J18-TH26	-	4932430284	4002395379453	
M18 HPT, M18 BLHPT				32	M18	J18-TH32	-	4932430286	4002395379477	
M18 BLHPT, M18 HPT				40	M18	RJ18-TH40	RJA-1	4932430288	4002395379491	
M18 HPT, M18 BLHPT				50	M18	RJ18-TH50	RJA-1	4932430289	4002395379507	
M18 HPT, M18 BLHPT				63	M18	RJ18-TH63	RJA-1	4932430290	4002395379514	
				M18 HPT, M18 BLHPT	-	M18	RJA-1	-	4932430307	4002395379682



Jaw profile	Fits to following pipe system suppliers	Fits Milwaukee Press tool	Nominal size	Tool suitability	Description	Requires	Article Number	EAN Code	
a.	MP	Viega: Mega Press	M18 BLHPT, M18 ONE-BLHPT, M18 BLHPTXL	1/2"	M18	J18-MP1/2"	-	4932479442	4058546372361
			M18 BLHPT, M18 ONE-BLHPT, M18 BLHPTXL	3/4"	M18	J18-MP3/4"	-	4932479443	4058546372378
			M18 BLHPT, M18 ONE-BLHPT, M18 BLHPTXL	1"	M18	J18-MP1"	-	4932479444	4058546372385
			M18 BLHPT, M18 ONE-BLHPT, M18 BLHPTXL	1 1/4"	M18	RJ18-MP1 1/4"	RJA-1	4932479445	4058546372392
			M18 BLHPT, M18 ONE-BLHPT, M18 BLHPTXL	1 1/2"	M18	RJ18-MP1 1/2"	RJA-1	4932479446	4058546372408
			M18 BLHPT, M18 ONE-BLHPT, M18 BLHPTXL	2"	M18	RJ18-MP2"	RJA-1	4932479447	4058546372415
b.			M18 BLHPTXL	2 1/2"	M18	RJ18XL-MP2 1/2"	RJAXL-1	4932479448	4058546372422
			M18 BLHPTXL	3"	M18	RJ18XL-MP3"	RJAXL-1	4932479449	4058546372439
			M18 BLHPTXL	4"	M18	RJ18XL-MP4"	RJAXL-1	4932479450	4058546372446
			M18 BLHPTXL	-	M18	RJAXL-1	-	4932479451	4058546372453



Jaw profile	Fits to following pipe system suppliers	Fits Milwaukee Press tool	Nominal size	Tool suitability	Description	Requires	Article Number	EAN Code	
a.	FF	Geberit FlowFit	M12 HPT, M12 ONEHPT	16-40	M12	J12-FF 16-40 Geberit	-	4932480981	4058546412661
b.			M18 BLHPT, M18 ONEBLHPT	16-40	M18	J18-FF 16-40 Geberit	-	4932480982	4058546412678
			M18 BLHPT, M18 ONEBLHPT	50-75	M18	J18-FF 50-75 Geberit	-	4932480983	4058546412685



SYSTEM ATTACHMENTS - PRESS JAWS

	Jaw profile	Fits to following pipe system suppliers	Fits Milwaukee Press tool	Nominal size	Tool suitability	Description	Requires	Article Number	EAN Code
a.			M12 HPT, M12 ONEHPT	12	M12	J12-M12 Geberit	-	4932480879	4058546411640
			M12 HPT, M12 ONEHPT	15	M12	J12-M15 Geberit	-	4932480880	4058546411657
			M12 HPT, M12 ONEHPT	18	M12	J12-M18 Geberit	-	4932480881	4058546411664
			M12 HPT, M12 ONEHPT	22	M12	J12-M22 Geberit	-	4932480882	4058546411671
			M12 HPT, M12 ONEHPT	28	M12	J12-M28 Geberit	-	4932480883	4058546411688
b.	M	Geberit: Mapress	M18 BLHPT, M18 ONEBLHPT	12	M18	J18-M12 Geberit	-	4932480885	4058546411701
			M18 BLHPT, M18 ONEBLHPT	15	M18	J18-M15 Geberit	-	4932480886	4058546411718
			M18 BLHPT, M18 ONEBLHPT	18	M18	J18-M18 Geberit	-	4932480887	4058546411725
			M18 BLHPT, M18 ONEBLHPT	22	M18	J18-M22 Geberit	-	4932480888	4058546411732
			M18 BLHPT, M18 ONEBLHPT	28	M18	J18-M28 Geberit	-	4932480889	4058546411749
			M18 BLHPT, M18 ONEBLHPT	35	M18	J18-M35 Geberit	-	4932480890	4058546411756



	Jaw profile	Fits to following pipe system suppliers	Fits Milwaukee Press tool	Nominal size	Tool suitability	Description	Requires	Article Number	EAN Code
a.			M12 HPT, M12 ONEHPT	16	M12	J12-G16 Geberit	-	4932480891	4058546411763
			M12 HPT, M12 ONEHPT	20	M12	J12-G20 Geberit	-	4932480892	4058546411770
			M12 HPT, M12 ONEHPT	26	M12	J12-G26 Geberit	-	4932480893	4058546411787
			M12 HPT, M12 ONEHPT	32	M12	J12-G32 Geberit	-	4932480894	4058546411794
			M12 HPT, M12 ONEHPT	40	M12	J12-G40 Geberit	-	4932480895	4058546411800
b.	G	Geberit: Mepla & Mepla Therm	M18 BLHPT, M18 ONEBLHPT	16	M18	J18-G16 Geberit	-	4932480896	4058546411817
			M18 BLHPT, M18 ONEBLHPT	20	M18	J18-G20 Geberit	-	4932480897	4058546411824
			M18 BLHPT, M18 ONEBLHPT	26	M18	J18-G26 Geberit	-	4932480898	4058546411831
			M18 BLHPT, M18 ONEBLHPT	32	M18	J18-G32 Geberit	-	4932480899	4058546411848
			M18 BLHPT, M18 ONEBLHPT	40	M18	J18-G40 Geberit	-	4932480900	4058546411855
			M18 BLHPT, M18 ONEBLHPT	50	M18	J18-G50 Geberit	-	4932480901	4058546411862
			M18 BLHPT, M18 HPT	63	M18	RJ18-G63 Geberit	-	4932480966	4058546412517
			M18 BLHPT, M18 HPT	75	M18	RJ18-G75 Geberit	-	4932480967	4058546412524
			M18 BLHPT, M18 HPT	-	M18	RJA Geberit	-	4932480968	4058546412531



	Jaw profile	Fits to following pipe system suppliers	Fits Milwaukee Press tool	Nominal size	Tool suitability	Description	Requires	Article Number	EAN Code
a.			M12 HPT, M12 ONEHPT	1/4"	M12	J12-BMP 1/4"	-	4932493155	4058546480264
			M12 HPT, M12 ONEHPT	3/8"	M12	J12-BMP 3/8"	-	4932493156	4058546480271
			M12 HPT, M12 ONEHPT	1/2"	M12	J12-BMP 1/2"	-	4932493157	4058546480288
			M12 HPT, M12 ONEHPT	5/8"	M12	J12-BMP 5/8"	-	4932493158	4058546480295
			M12 HPT, M12 ONEHPT	3/4"	M12	J12-BMP 3/4"	-	4932493159	4058546480301
			M12 HPT, M12 ONEHPT	7/8"	M12	J12-BMP 7/8"	-	4932493160	4058546480318
			M12 HPT, M12 ONEHPT	1"	M12	J12-BMP 1"	-	4932493161	4058546480325
b.	BMP	Conex & Bänninger >B< MaxiPro	M18 BLHPT, M18 BLHPTXL, M18 ONEBLHPT	1/4"	M18	J18-BMP 1/4"	-	4932493163	4058546480349
			M18 BLHPT, M18 BLHPTXL, M18 ONEBLHPT	3/8"	M18	J18-BMP 3/8"	-	4932493164	4058546480356
			M18 BLHPTXL, M18 BLHPT, M18 ONEBLHPT	1/2"	M18	J18-BMP 1/2"	-	4932493165	4058546480363
			M18 BLHPT, M18 BLHPTXL, M18 ONEBLHPT	5/8"	M18	J18-BMP 5/8"	-	4932493166	4058546480370
			M18 BLHPT, M18 BLHPTXL, M18 ONEBLHPT	3/4"	M18	J18-BMP 3/4"	-	4932493167	4058546480387
			M18 BLHPT, M18 BLHPTXL, M18 ONEBLHPT	7/8"	M18	J18-BMP 7/8"	-	4932493168	4058546480394
			M18 BLHPT, M18 BLHPTXL, M18 ONEBLHPT	1"	M18	J18-BMP 1"	-	4932493169	4058546480400
			M18 BLHPT, M18 BLHPTXL, M18 ONEBLHPT	1 1/8"	M18	J18-BMP 1 1/8"	-	4932493170	4058546480417



PIVOTING RING JAWS

	Jaw profile	Fits to following pipe system suppliers	Fits Milwaukee Press tool	Nominal size	Tool suitability	Description	Requires	Article Number	EAN Code
a.	M	Geberit: Mapress VSH: X-Press Eurotubi Raccorderie Metallique Rubinetteria Bresciane Sanha: Niroso Pegler Yorkshire	M12 HPT, M12 ONEHPT, M18 BLHPT, M18 ONEBLHPT	15	M12/M18	PRJ12/18-M15	PRJA-M12/ PRJA-M18	4932500083	4058546572471
			M12 HPT, M12 ONEHPT, M18 BLHPT, M18 ONEBLHPT	18	M12/M18	PRJ12/18-M18	PRJA-M12/ PRJA-M18	4932500084	4058546572488
			M12 HPT, M12 ONEHPT, M18 BLHPT, M18 ONEBLHPT	22	M12/M18	PRJ12/18-M22	PRJA-M12/ PRJA-M18	4932500085	4058546572495
			M12 HPT, M12 ONEHPT, M18 BLHPT, M18 ONEBLHPT	28	M12/M18	PRJ12/18-M28	PRJA-M12/ PRJA-M18	4932500086	4058546572501
			M12 ONEHPT, M12 HPT, M18 BLHPT, M18 ONEBLHPT	35	M12/M18	PRJ12/18-M35	PRJA-M12/ PRJA-M18	4932500087	4058546572518
b.	V	Viega Comap IBP Sanha: Niroso	M12 HPT, M12 ONEHPT, M18 BLHPT, M18 ONEBLHPT	15	M12/M18	PRJ12/18-V15	PRJA-M12/ PRJA-M18	4932500088	4058546572525
			M12 HPT, M12 ONEHPT, M18 BLHPT, M18 ONEBLHPT	18	M12/M18	PRJ12/18-V18	PRJA-M12/ PRJA-M18	4932500089	4058546572532
			M12 HPT, M12 ONEHPT, M18 BLHPT, M18 ONEBLHPT	22	M12/M18	PRJ12/18-V22	PRJA-M12/ PRJA-M18	4932500090	4058546572549
			M12 HPT, M12 ONEHPT, M18 BLHPT, M18 ONEBLHPT	28	M12/M18	PRJ12/18-V28	PRJA-M12/ PRJA-M18	4932500091	4058546572556
			M12 HPT, M12 ONEHPT, M18 BLHPT, M18 ONEBLHPT	35	M12/M18	PRJ12/18-V35	PRJA-M12/ PRJA-M18	4932500092	4058546572563



PRESS JAW ACR STREAMLINE

	Jaw profile	Fits to following pipe system suppliers	Fits Milwaukee Press tool	Nominal size	Tool suitability	Description	Requires	Article Number	EAN Code
a.	ACR	Sanha Streamline ACR	M18 BLHPT, M18 BLHPTXL, M18 ONEBLHPT	1/2"	M18	J18-ACR 1/2"	-	4932500103	4058546572679
	ACR		M18 BLHPT, M18 BLHPTXL, M18 ONEBLHPT	1/4"	M18	J18-ACR 1/4"	-	4932500101	4058546572655
	ACR		M18 ONEBLHPT, M18 BLHPTXL, M18 BLHPT	3/4"	M18	J18-ACR 3/4"	-	4932500105	4058546572693
	ACR		M18 BLHPT, M18 BLHPTXL, M18 ONEBLHPT	3/8"	M18	J18-ACR 3/8"	-	4932500102	4058546572662
	ACR		M18 BLHPTXL, M18 BLHPT, M18 ONEBLHPT	5/8"	M18	J18-ACR 5/8"	-	4932500104	4058546572686
	ACR		M18 BLHPTXL, M12 ONEHPT, M18 ONEBLHPT	7/8"	M18	J18-ACR 7/8"	-	4932500106	4058546572709
	ACR		M18 BLHPTXL, M18 BLHPT, M18 ONEBLHPT	1 1/8"	M18	RJ18-ACR 1 1/8"	RJA-1	4932500107	4058546572716
	ACR		M18 BLHPTXL, M18 BLHPT, M18 ONEBLHPT	1 3/8"	M18	RJ18-ACR 1 3/8"	RJA-1	4932500108	4058546572723



EMPTY PACKOUT™ FOAM INSERT

	Description	Article Number	EAN Code
a.	Empty M12 HPT presstool PACKOUT™ foam insert	4932498246	4058546521158
b.	Empty M18 BLHPT/ONEBLHPT presstool PACKOUT™ foam insert	4932498247	4058546521165
c.	Empty 4x ring jaw and RJ adaptor PACKOUT™ foam insert	4932498248	4058546521172
d.	Empty M108 XL presskit PACKOUT™ foam insert	4932498249	4058546521189

SYSTEM ATTACHMENTS - POLISHERS

PREMIUM POLISHING ACCESSORIES - SPONGES

	Description	Diameter (mm)	Thickness (mm)	Pack quantity	Article Number	EAN Code
a.	Sponge Red Coarse 140 / 20 mm	140	20	2	4932492310	4058546416775
	Sponge Red Coarse 140 / 25 mm	140	25	2	4932492319	4058546416867
	Sponge Red Coarse 160 / 20 mm	160	20	2	4932492316	4058546416836
b.	Sponge Yellow Fine 140 / 20 mm	140	20	2	4932492311	4058546416782
	Sponge Yellow Fine 140 / 25 mm	140	25	2	4932492320	4058546416874
	Sponge Yellow Fine 160 / 20 mm	160	20	2	4932492317	4058546416843
c.	Sponge Blue Ultra Fine 140 / 20mm	140	20	2	4932492312	4058546416799
	Sponge Blue Ultra Fine 140 / 25 mm	140	25	2	4932492321	4058546416881
	Sponge Blue Ultra Fine 160 / 20 mm	160	20	2	4932492318	4058546416850



PREMIUM POLISHING ACCESSORIES - CLOTHS

	Description	Features	Length (mm)	Width (mm)	Pack quantity	Article Number	EAN Code
a.	Cloth Red 400 x 400 mm	Cloths: Microfibre polishing cloths. Super-soft premium microfibre polishing cloth for finishing gloss polishing. With good absorption properties perfectly suited for final finishing and removing water spots from sensitive surfaces. Colour coded for use with respective sponges and compounds to avoid contamination. Machine-washable with 30° without softener.	400	400	2	4932492306	4058546416737
b.	Cloth Yellow 400 x 400 mm		400	400	2	4932492307	4058546416744
c.	Cloth Blue 400 x 400 mm		400	400	2	4932492308	4058546416751

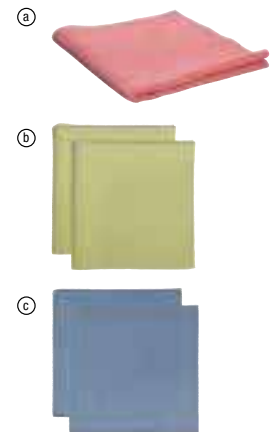

PREMIUM POLISHING ACCESSORIES - COMPOUNDS

	Description	Features	Article Number	EAN Code
a.	Compound Red Coarse 1l	Polish 1500 compound. A coarse 1500 grit polish for removing deep scratches without damaging the lacquer. Suitable for removing dust grains, orange peel texture, lacquer/paints runs and deep scratches. Free of wax, silicone and toxic solvents. Recommended for use with polishing red hard coarse sponge and red cloth.	4932492300	4058546416676
b.	Compound Yellow Fine 1l	Polish 2000 compound. A coarse 2000 grit polish for removing fine scratches without damaging the lacquer. Free of wax, silicone and toxic solvents. Recommended for use with polishing yellow soft fine sponge and yellow cloth.	4932492301	4058546416683
c.	Compound Blue Ultra Fine 1l	Polish compound 3000. A medium fine compound with 3000 grit for removing fine scratches, holograms and swirls. Free of silicone. Recommended for use with polishing super fine blue sponge and blue microfibre polishing cloth.	4932492302	4058546416690



PREMIUM POLISHING ACCESSORIES - HOOK & LOOP Ø 125 MM

	Description	Diameter (mm)	Height (mm)	Article Number	EAN Code
a.	Polishing backing pad with M14 thread. Very flat design with excellent flexibility. Low vibration allows precise work on any flat and curved profiles	125		4932430394	4002395380558
b.	Polisher backing pad for M18 FROPBP125	125		4932479964	4058546377588
c.	Lambswool polishing disc. 100% natural lambswool. Premium quality with extremely high fibre density for longer lifetime. Integrated soft touch layer guarantees perfect adjustment to flat and curved profiles. For finishing old and fresh paint. Extremely good polishing of temperature sensitive clear lacquers thanks to heat resistant fibres, e.g. polishing car bumper	135	25	4932430395	4002395380565
d.	Polishing sponge hard. Hard sponge with coarse foam structure. For maximum removal of the reconditioning lacquer, removing deep scratches and polishing weather-beaten lacquer	145	30	4932430396	4002395380572
e.	Polishing sponge soft. Extremely soft sponge with fine foam structure. For fine polishing with polishing creams / wax compounds to remove very fine scratches and holograms (swirls)	145	30	4932430397	4002395380589
f.	Microfibre polishing cloth. Super-soft premium microfibre polishing cloth for finishing gloss polishing. With good absorption properties perfectly suited for final finishing and removing water spots from sensitive surfaces. Machine-washable with 30° without softener	400 x 400		4932430398	4002395380596
g.	Polish M-Cut 1500 (250 ml). A coarse 1500 grit polish for removing deep scratches without damaging the lacquer. Suitable for removing dust grains, orange peel texture, lacquer/paints runs and deep scratches. Free of wax, silicone and roxic solvents. Recommended for use with polishing sponge hard (4932430396) and lambswool polishing disc (4932430395)			4932430475	4002395381364
h.	Polish M-Wax 6000 (250 ml). Premium high-tech wax with 6000 grit for removing fine scratches and sealing the paintwork in one step. Excellent performance in removing fine scratches / holograms / swirls. Contains the finest Brazilian Carnuba wax for long lasting mirror-like shine. Free of silicone. Recommended for use with polishing sponge soft (4932430397) and microfibre polishing cloth (4932430398)			4932430476	4002395381371



POLISHING ACCESSORIES - HOOK & LOOP Ø 150 MM

	Description	Diameter (mm)	Height (mm)	Article Number	EAN Code
a.	Polishing backing pad. Application: Reception of felt / lambswool polishing discs and sponges. Characteristics: M14 thread, break resistant with integrated soft and flexible foam layer, Hook & Loop fixation	150	25	4932373161	4002395347285
b.	Polisher backing pad for M18 FROPBP150	150		4932479965	4058546377595
c.	Backind pad for M12 FUEL™ 150 mm random orbital sander - Soft and Hook & Loop	150		4932499244	4058546564087
d.	Backind pad for M12 FUEL™ 150 mm random orbital sander - Hard and Hook & Loop	150		4932499245	4058546564094
e.	Backind pad for M12 FUEL™ 150 mm random orbital sander - Soft and PSA	150		4932499246	4058546564100
f.	Backind pad for M12 FUEL™ 150 mm random orbital sander - Hard and PSA	150		4932499247	4058546564117
g.	Felt polishing disc. Application: second polishing / finish of new lacquer work (spray mist and inclusion of dust), non ferrous metals and stainless steel, can also be used with polishing paste. Requires polishing backing	150	25	4932373163	4002395347902
h.	Lambswool polishing disc. Finishing high gloss polishing	150	25	4932373164	4002395347926
i.	Polishing sponge hard. Polish up of weather-beaten lacquer, lacquer re-conditioning	150	50	4932373165	4002395347940
j.	Polishing sponge soft. Second polish of lacquer, lacquer care	150	50	4932373186	4002395347964

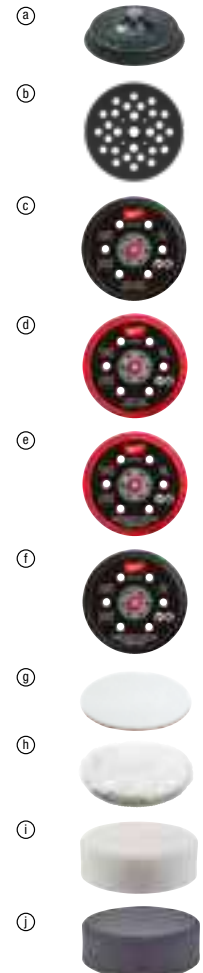

POLISHING ACCESSORIES - SPOT POLISHER

	Description	Diameter (mm)	Height (mm)	Article Number	EAN Code
a	Polishing / Sanding backing pad. Thread: M9 x 0.75. Hook and loop fixation. For use with polishing sponges and abrasive paper	76		4932430488	4002395381494
b	Polishing sponge - Hard (yellow). Hard sponge for use with more aggressive polish for removal of deep scratches. Hook and loop fixation. For use with polishing / sanding backing pad	75	25	4932430489	4002395381500
c	Polishing sponge - Soft (white). Soft sponge for use with light polish for removal of small scratches. Hook and loop fixation. For use with polishing / sanding backing pad	80	25	4932430490	4002395381517
d	Lambswool polishing pad. Hook and loop fixation. For use with polishing / sanding backing pad	80		4932430838	4002395385003
e	Fibre disc backing pad. Thread: M9 x 0.75 to affix to tool. Knurled thread to fix coated abrasives and surface finishing products for coarse sanding applications, such as rust removal. Ideal for sanding small or awkward to reach areas such as pinch welds, door shuts and wheel arches	46		4932430492	4002395381531



SYSTEM ATTACHMENTS - SANDERS

BELT SANDERS

	Description	Fits belt sanders	Article Number	EAN Code
a.	Dust bag (spare)	BS 100 S, BS 100 LE	4932336597	4002395311026
b.	Pair of clamps for MILWAUKEE® belt sander.		4932459653	4058546028251



RANDOM ORBITAL SANDERS

	Description	Diameter (mm)	Fits Milwaukee Random Orbital Sanders	Article Number	EAN Code
a.	Base plate Ø 125 mm, 8 holes. Complete with rubber ring as spare	125	ROS 125 E	4932430091	4002395377527
a.	Base plate Ø 150 mm, 6 holes. Complete with rubber ring as spare	150	TXE 150,ROS 150 E	4932357591	4002395343317
			ROS 150 E-2	4932430145	4002395378067
b.	75 mm sanding base for M12 FSDR75	75	M12 FSDR75	4932499472	4058546566364
c.	125 mm sanding base for M18 FROS125	125	M18 FROS125	4932500123	4058546572877
	Clean Line System. Frame with dust bag	125	ROS 125 E	4931435448	4002395889563
		150	ROS 150	4931435911	4002395874729
	Spare paper bags for 4932345544 (5pc)		TXE 150,TX 125,ROS 150 E	4931442873	4002395247882
	Frame holder for dust bag 4932313096	125/150	ROS 150 E, TXE 150	4931329719	4002395610938
d.	Lambswool polishing disc. Finishing high gloss polishing	150	ROS 150,ROS 150 E, TXE 150	4932373164	4002395347926
e.	Lambswool polishing disc. 100% natural lambswool. Premium quality with extremely high fibre density for longer lifetime. Integrated soft touch layer guarantees perfect adjustment to flat and curved profiles. For finishing old and fresh paint. Extremely good polishing of temperature sensitive clear lacquers thanks to heat resistant fibres, e.g. polishing car bumper	135	TX 125,ROS 125 E	4932430395	4002395380565
f.	Polishing sponge hard. Polish up of weather-beaten lacquer, lacquer re-conditioning	150	TXE 150,ROS 150 E,ROS 150	4932373165	4002395347940



SYSTEM ATTACHMENT - SAWZALL™

	Description	Fits Milwaukee SAWZALL	Article Number	EAN Code	
a.	Conversion kit: to convert FIXTEC™ blade reception models to keyed blade reception to accept 20 mm reception blades	Clamp	42680685	4058546073183	
		Screw	SSE 1000 QX,SSPE 1000 QX,SSH 800 QX Hatchet,PSH 18v hatchet,V18 SX,SSPE 1300 QX,M18 FUEL™ SAWZALL,USE 980 X,V28 SX,SSPE 1500 X	06832976	4058546069193
		Allen key 5/32"	49960070	045242221554	
b.	Conversion kit: to convert FIXTEC™ blade reception models to keyed blade reception to accept 1/2" universal reception blades	Clamp	49225016	045242182060	
		Screw	SSE 1000 QX,SSPE 1000 QX,SSH 800 QX Hatchet,PSH 18v hatchet,V18 SX,SSPE 1300 QX,M18 FUEL™ SAWZALL,USE 980 X,V28 SX,SSPE 1500 X	06832976	4058546069193
		Allen key 5/32"	49960070	045242221554	
c.	Pipe clamp	Fits to the current cordless FUEL™ SAWZALL™s (FSZ, FSX)	4932478816	4058546360986	

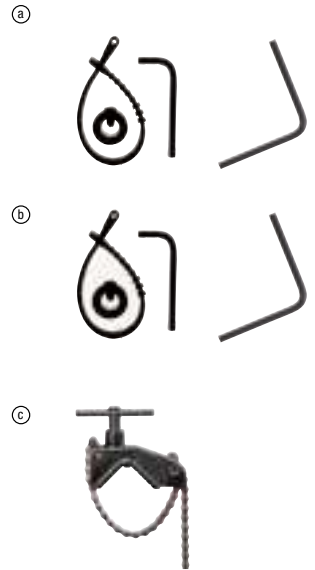

SYSTEM ATTACHMENTS - JIGSAWS

	Description	Article Number	EAN Code	
a.	Gliding shoe for materials with delicate surfaces	For HD18, BST18, JS120, JSPE 135, STEP 1200, JSPE90, FSPE 110, BSPE110, STEP800, ST800, V28 JSB	4932430356	4002395380176
		For STEP 70, STEP 75, ST700, STEP90, STEP 100, FSPE100, BSPE100	4932430834	4002395384969



SYSTEM ATTACHMENT - NAILERS

	Description	Article Number	EAN Code
a.	Extended magazine for M18 FUEL™ framing nailer	4932471605	4058546295042



SYSTEM ATTACHMENTS - DIE GRINDERS

	Description	Fits Milwaukee Die Grinders	Article Number	EAN Code
a.	Ø 3 mm collet	DGL 34,DGL 30 E,DG 30 E,PSG 12,PSG 14.4 PP,HD18 SG	4932308974	4002395309092
	Ø 3 mm collet	M18 FDG	4932471202	4058546288303
	Ø 6 mm collet	PSG 14.4 PP,HD18 SG,PSG 12,DG 30 E,DGL 30 E,DGL 34	4932313192	4002395302833
	Ø 6 mm collet	DG 7 E	4931391453	4002395734818
	Ø 6 mm collet	DG 14-50 Q	48660978	045242155620
	Ø 8 mm collet	DGL 34,DGL 30 E,DG 30 E,PSG 12,PSG 14.4 PP,HD18 SG,V 28 SG	4932313190	4002395302840
	Ø 8 mm collet	DG 7 E	4931391452	4002395734801
	Ø 6.35 mm (1/4") collet	DGL 34,DGL 30 E,DG 30 E,PSG 12,PSG 14.4 PP,HD18 SG	4932313194	4002395302857
b.	Rubber Sleeve for M12 FDGA	M12 FDGA	4932478759	4058546360412



SYSTEM ATTACHMENTS - PLATE SHEARS

	Description	Fits Milwaukee Plate Shears	Article Number	EAN Code
a.	Piston four sided blade	PPS 12	4932308837	4002395311583
b.	Cutting table blade four sided blade	KS 2.5,S 2.5	4932430171	4002395378326
		PPS 12	4932308838	4002395309085
c.	Centre blade	SMC 1.2 Q	48440150	045242140701
d.	Left blade	SMC 1.2 Q	48440160	045242140756
e.	Right blade	SMC 1.2 Q	48440170	045242140800
f.	Socket wrench 5/16"	SMC 1.2 Q	49960070	045242221554
g.	Replacement shear head assembly.	SMC 1.2 Q	48080500	045242089253

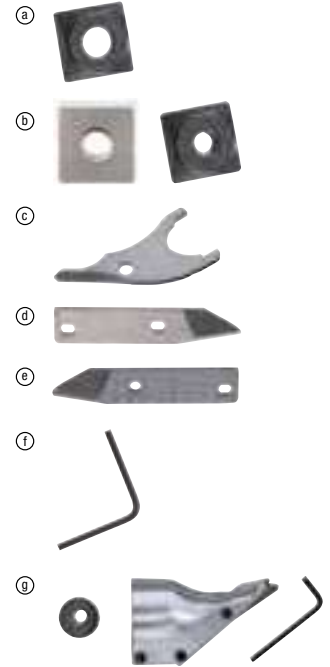

SYSTEM ATTACHMENTS - NIBBLERS

	Description	Fits nibblers	Article Number	EAN Code	
a.	Punch	KN 2	PN 14.4,PN 12,N 2	4932430172	4002395378333
b.	Die	KN 2	PN 14.4,PN 12,N 2	4932279565	4002395308521
c.	Die and punch set for M12 FUEL™ sub compact 1.6 mm nibbler	KN 2	PN 14.4,PN 12,N 2	4932479353	4058546371470
d.	Die holder extension for M12 FUEL™ sub compact 1.6 mm nibbler	KN 2	PN 14.4,PN 12,N 2	4932479354	4058546371487
e.	Special die. Especially designed for cutting corrugated steel. Max. cutting capacity 1.5 mm	KN 2	PN 14.4,PN 12,N 2	4932279498	4002395308514



SYSTEM ATTACHMENTS - WALL CHASERS

- AUDD blade is a perfect solution for 80% of wall chaser applications
- - 30% less loading on the machine compared to the MILWAUKEE® DU blade
- - 40% higher speed of cut compared to the MILWAUKEE® DU blade
- ✓ Maximum performance ♦ Limited suitability - recommended for intermittent use

	a.	b.	c.
	HUDD	AUDD	DSU
Abrasive refractory materials	♦	✓	
Aerated and breeze concrete blocks	♦	✓	♦
Brick medium to soft	✓	✓	✓
Concrete medium	✓	✓	✓
Concrete reinforced with rebar	✓	♦	✓
Concrete with flint and rebar	♦	✓	
Fireclay	✓	✓	✓
General building materials	✓	✓	✓
Granite	✓		✓
Lime and sandstone blocks soft and abrasive	♦	✓	♦
Lime and sandstone blocks medium	✓	✓	
Screed	♦	✓	✓

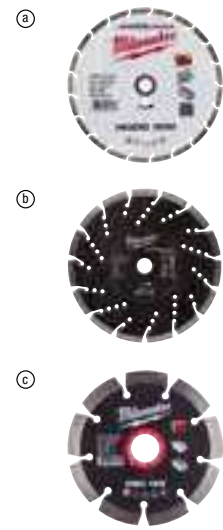

	Description	Fits wall chasers	Article Number	EAN Code
a.	Transport case for wall chasers	WCE 30,WCS 45,DME 30,DME 45	4932383357	4002395357390
b.	Two hole spanner straight	DME 30, DME 45, WCS 45, DME 65, WCE 65,WCE 30	4932367712	4002395338467
c.	T-handle key	WCE 30, WCS 45, WCE 65,DME 30, DME 45,DME 65	4931362928	4002395661879
d.	Dust protection grille against entry of ground particles	WCE 30, WCS 45, DME 30,DME 45	4932329397	4002395303892
e.	Dust protection grille against entry of ground particles	WCE 65, DME 65	4932326525	4002395303311
f.	Adaptor with bayonet fitting for direct connection of hose to machine	WCE 30, WCS 45, WCE 65,DME 30, 'DME 45,DME 65	4932362778	4002395334285
g.	Side handle	WCE 30,WCS 45, DME 30,DME 45	4932409546	4002395370870
h.	Flange nut	DME 1300	4932334667	4002395304448
i.	Clamping flange	DME 1300	4932334706	4002395304455
j.	Spacer set. Contents 6 rings		4931334675	4002395762804



SYSTEM ATTACHMENTS - SCREWDRIVERS

	Description	Fits Milwaukee Corded Screwdrivers	Article Number	EAN Code
a	Drywall sleeve assembly	DWE 4000 Q, DWSE 4000 Q, TKSE 2500 Q, 6790, 6743	49261036	045242185245
b	Self drill sleeve assembly	TKSE 2500 Q, 6790	49261082	045242185375
	1/4" magnetic bit holder 76 mm	DWE 4000 Q, DWSE 4000 Q, 6743	48323065	045242128600
	1/4" magnetic bit holder 76 mm, requires additionally 49261036 sleeve assembly	TKSE 2500 Q, 6790	48323070	045242128655
c	Hex socket driver set (3pc)	TKSE 2500 Q, 6790, TQSE 1200 Q, TQSE 2500 Q, 6580, 6581	49663004	045242207848
	Ø 6 / 8 / 10 mm magnetic sockets			
d	Collated attachment for M18 FSG		4933459202	4002395289974
e	PH2 148 mm drywall screwdriving bit for M18 FSG		4932459393	4058546010546
f	Mag / ring drywall bit holder 75 mm for M18 FSG		4932459394	4058546010553
g	Offset attachment 1/4" hex M12FPDX		4932464481	4058546224264
h	M12 FPDX-RAA Right angle attachment for drilling and screwdriving applications in confined spaces. 90° angle. 12 fixing positions. Direct bit reception.		4932464480	4058546224257
i	13 mm Keyless chuck to suit M12 FPDX sub compact percussion drill		4932464479	4058546224240
j	Rivet tool nose set		48540100	045242504466
k	152mm Nose extension kit- for M12™ rivet tool		48950100	045242504459
l	M12 BDDX-OA offset attachment for screwdriving applications - 12 fixing positions		4932430432	4002395380930
m	M12 BDDX-RAA right angle attachment for drilling and screwdriving applications in confined spaces - 90° angle - 12 fixing positions - direct bit reception		4932430433	4002395380947
n	Retention nose pieces set for M18 FUEL™ rivet tool with ONE-KEY™		4932478961	4058546362430
o	Extension nose piece for M18 FUEL™ rivet tool with ONE-KEY™		4932478962	4058546362447



SIDE HANDLES

	Description	Article Number	EAN Code
a	Side handle with depth gauge for all drills and percussion drills with gear neck diameter 43 mm	4932373725	4002395352647
b	Side handle with depth gauge for all drills and percussion drills with a short gear neck (13 mm) of diameter 43 mm	4932364149	4002395342198



QUIK-LOK™ CABLES

	Article Number	EAN Code		
a.	4	EU	4932373502	4002395351725
	10	EU	4932373503	4002395351732
	4	CH	4932373504	4002395351749
	4	GB	4932373508	4002395351787
	4	GB	4932373510	4002395351800
	6	EU	4932364483 ¹	4002395337620
b.	QUIK-LOK™ cable repair kit		4931380758	4002395714551

¹Heavy duty and acid resistant, non repairable



UNIVERSAL RIGHT ANGLE DRILL ATTACHMENT

- Converts MILWAUKEE® HDE 13 RQD straight drill to angle drill.
- Used extensively for drilling between joists or in tight corners.
- Head and handle swivel 360°.
- Provides two speeds: 1. Low: speed decreases by 30% torque increases by 50% 2. High: speed increases by 50%

	Description	Article Number	EAN Code
a.	Right angle drill attachment	48062871	045242088812

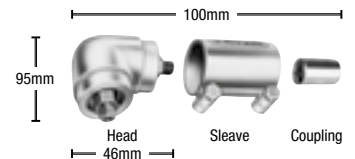

Head and handle swivel 360° and be locked tight in any position.

RUBBER SLEEVES FOR IMPACT WRENCHES

	Description	Article Number	EAN Code
a.	Rubber sleeve for M18 ONEFIW2FC12	4932498145	4058546513054
b.	Rubber sleeve for M18 ONEFMTIW2FC12	4932498144	4058546513047
c.	Rubber sleeve for M18 ONEFHIWF1	4932478760	4058546360429
d.	Rubber sleeve for M18 ONEFHIWF1	4932479975	4058546377694
e.	Rubber sleeve for M18 FHIWF12, M18 ONEFHIWF12 & M18 ONEFHIWF34	49162767	045242506422
f.	Rubber sleeve for M18 FHIWP12 & M18 ONEFHIWP12	49162766	045242506415
g.	Rubber sleeve for M18 FHIW2F12	4932493560	4058546484316
h.	Rubber sleeve for M18 FHIW2P12	4932493581	4058546484521
i.	Rubber sleeve for M18 FIW2F & M18 FIW2P	4932478770	4058546360528
j.	Rubber sleeve for M18 FMTIW2F & M18 FMTIW2P	4932478771	4058546360535
k.	Rubber sleeve for M18 FMTIWP	49162861	045242510146
l.	Rubber sleeve for M18 CHIW and M28 CHIW	49162763	045242324255
m.	Rubber sleeve for M18 CIW	49162754	045242320455
n.	Rubber sleeve for M12 FIWF	4932478758	4058546360405
o.	Rubber sleeve for M12 FIR38	4932479100	4058546368944
p.	Rubber sleeve for M12 FRAIW38 & M12 FRAIW12	4932479098	4058546368920
q.	Rubber sleeve for M12 FID	4932479102	4058546368968
r.	Rubber sleeve for M12 FID2	4932479977	4058546377717
s.	Rubber sleeve for M18 FID2	4932479103	4058546368975
t.	Rubber sleeve for M18 FID3	4932479974	4058546377687



SYSTEM ATTACHMENTS - ROTARY HAMMERS

ROTARY HAMMERS CHUCK ADAPTORS

	Description	Reception	Tool drive	Only suitable for	Article Number	EAN Code
a	FIXTEC - SDS-Plus	SDS-Plus	FIXTEC	-	4932379877	4002395346561
b	FIXTEC - SDS-Plus	SDS-Plus	FIXTEC	BH 26 LXE, PLH 16 QEX, V28 HX, V18 HX, PLH 26 QEX, PH 30 POWER X	4932399152	4002395367628
c	FIXTEC - SDS-Plus	SDS-Plus	FIXTEC	PH 26 X, KH24 XE, KH 26 XE, KH 28 SUPER XE.	4932352299	4002395369584
d	FIXTEC - 1/2" x 20 UNF 1	1/2" x 20 UNF	FIXTEC	PH 26 X, KH 24 XE, KH 24 XE, KH 26 XE, KH 28 Super XE.	4932371807	4002395344710
e	FIXTEC - 1/2" x 20 UNF 2	1/2" x 20 UNF	FIXTEC	PLH 16 QEX, V 28 HX, V 18 HX, PLH 26 QEX, PH 30 Power X, KH 26 XE, KH 24 XE, KH 28 Super XE, BH 26 LXE and PH 26 X.	4932399154	4002395357635
f	SDS-plus - 1/2" x 20 UNF 1. Chuck adaptor with direct bit reception (1/4" Hex) to accept screwdriving bits. Threaded housing enables adapter to be tightened to the chuck resulting in no wobble	1/2" x 20 UNF	SDS-Plus	-	4932367438	4002395337668
g	SDS-plus - 1/2" x 20 UNF 1. Chuck adaptor with retaining screw	1/2" x 20 UNF	SDS-Plus	-	4932367166	4002395334438

Ⓐ



Ⓑ



Ⓒ



Ⓓ



Ⓔ



Ⓕ



Ⓖ



KEYED CHUCKS

	Chuck jaws open (mm)	Drill reception	Locking device	Safety screw	Rotary drill	Percussion drill	Battery drill	Chuck key	Article Number	EAN Code
a.	1.5-13	1/2" x 20		✓	✓	✓	✓	A	4932267980	4002395300488
b.	3.0-16	Taper B16			✓			C	4932127010	4002395306169
c.	3.0-16	M18x2.5	✓	✓	✓	✓		C	4932320014	4002395310784



KEYED CHUCKS - MACHINE SPECIFIC

	Chuck jaws open (mm)	Drill reception	Fits Milwaukee Drill Drivers	Safety screw	Chuck key	Article Number	EAN Code
a.	1.0-10	3/8" x 24	HDE 6 RQ	✓	H	48660817	045242155705

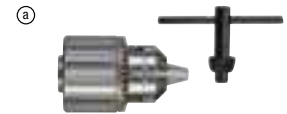

KEYED CHUCKS WITH 1/4" HEX RECEPTION

	Chuck jaws open (mm)	Drill reception	Battery drill	Chuck key	Article Number	EAN Code
a.	1.0-10	1/4" Hex	✓	A	4932314867	4002395300112



CHUCK KEYS

	Description	Type	Ref. No.	Article Number	EAN Code
a	Chuck key	A	S2A	4932221378	4002395302765
		B	S2AT	4932310612	4002395309177
		C	S3T	4932221379	4002395306381
		D	S14	4932304684	4002395300105
		E	S4	4932221380	4002395306398
		G	S2	4932319995	4002395303724
		H		48663350	045242157600
		J		48663240	045242157501
		K	48663280	045242157556	
b	Morse taper No. 3 adaptor for chucks with B16 taper	MT3 - B16		4932117042	4002395305834
c.	Ejector tool DIN 317 size 3			4932604226	4002395311248



KEYLESS CHUCKS 2 SLEEVES

	Chuck jaws open (mm)	Reception	Locking device	Safety screw	Rotary drill	Percussion drill	Battery drill	Article Number	EAN Code
a.	1.0-10	3/8" x 24		✓	✓		✓	4932349457	4002395318155
b.	1.0-10	1/2" x 20	✓	✓	✓	✓	✓	4932364382	4002395337675
c.	1.5-13	1/2" x 20	✓		✓	✓	✓	4932376531	4002395346332
d.	1.5-13	1/2" x 20	✓	✓	✓	✓	✓	4932376533	4002395346349
e.	1.5-13	1/2" x 20	✓		✓	✓	✓	4932364265 ¹	4002395334056
f.	1.5-13	1/2" x 20	✓	✓	✓	✓	✓	4932364267	4002395334070

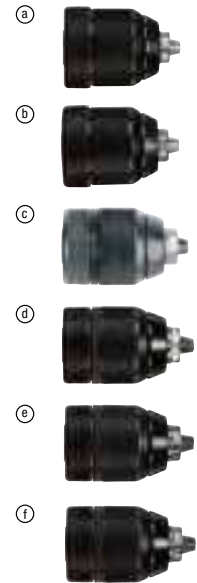

KEYLESS CHUCKS FOR FIXTEC (SPINDLE LOCK) MACHINES

	Chuck jaws open (mm)	Reception	Locking device	Safety screw	Rotary drill	Percussion drill	Battery drill	Article Number	EAN Code
a.	1.0-10	3/8" x 24	✓	✓	✓	✓	✓	4932371018	4002395339365
b.	1.0-10	1/2" x 20	✓	✓	✓	✓	✓	4932372443	4002395345458
c.	1.5-13	1/2" x 20	✓	✓	✓	✓	✓	4932371913	4002395345366
d.	1.5-13	3/8" x 24	✓	✓	✓	✓	✓	4932399492	4002395361137
e.	1.5-13	9/16" x 18	✓	✓	✓	✓	✓	4932478806 ¹	4058546360887



INDUSTRIAL KEYLESS CHUCKS FOR CORDED PERCUSSION DRILLS

	Chuck jaws open (mm)	Reception	Locking device	Rotary drill	Percussion drill	Battery drill	Article Number	EAN Code
a.	1.0-13	1/2" x 20	✓	✓	✓		4932364266	4002395334063



KEYLESS CHUCKS - SPECIFIC TOOL RELATED CHUCKS

	Chuck jaws open (mm)	Reception	Machine specific	Locking device	Rotary drill	Safety screw	Article Number	EAN Code
a.	1.0-10	1/2" x 20	HDE 10 RQX			✓	48661520	045242156795
b.	1.5-13	1/2" x 20	HDE 13 RQX			✓	42660755	4002395891436
c.	1.5-13	FIXTEC		✓	✓		4932399214	4002395358236
d.	1.0-10	FIXTEC	M12 BDDX		✓		4932430444	4002395381050



SYSTEM ATTACHMENTS - ANGLE GRINDERS

	Description	Fits 115 mm angle grinders	Fits 125 mm angle grinders	Fits 150mm angle grinders	Fits 180mm angle grinders	Fits 230mm angle grinders	Article Number	EAN Code
a.	Flange nut M14	✓	✓	✓	✓	✓	4932345628	4002395313105
b.	Backing flange	✓	✓	✓	✓	✓	4932449324	4002395245185
c.	Two hole spanner straight	✓	✓	✓	✓	✓	4932367712	4002395338467
d.	Open-ended spanner. SW 17/24	✓	✓	✓	✓	✓	4932345710	4002395307722
e.	Cranked two hole spanner for steel wire brushes				✓	✓	4932371469	4002395342181
f.	Dust protection grille against entry of ground particles		✓	✓			4932329397	4002395303892
					✓	✓	4932326525	4002395303311
	Side handle	✓	✓	✓			4932409546	4002395370870
g.	Anti-Vibration side handle	✓	✓	✓	✓ ¹		4932399991	4002395366507
					✓	✓	4932399992	4002395366514
	Hand protection guard						4932378478	4002395347353
Flange nut set. Only for AGV 16- 180 OXC		Suitable for WS 2300 (Australia version)					4932351632	4002395321636
Flange nut M14 (4932345629), backing flange (4932371404), large flange nut (4932367952)								

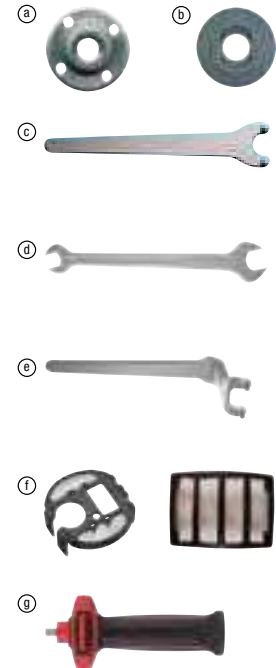

FLEXIBLE BACKING PADS

	Description	Bore size (mm)	Diameter (mm)	Fits 115 mm angle grinders	Fits 125 mm angle grinders	Fits 180mm angle grinders	Fits 230mm angle grinders	Article Number	EAN Code
a.	Flexible backing pad. Complete with flange nut M14 for all angle grinders	14.2	110	✓				4932345760	4002395313488
		14.2	125		✓			4932345761	4002395313495
		14.2	170			✓		4932345758	4002395313501
		22.2	170			✓		4932352744	4002395374021
b.	Replacement flange nut M14			✓	✓	✓	✓	4932345627	4002395313112

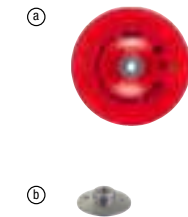

CUTTING AND GRINDING DUST EXTRACTION

	Description	Fits 115 mm angle grinders	Fits 125 mm angle grinders	Fits 180mm angle grinders	Fits 230mm angle grinders	Article Number	EAN Code
a.	Dust guard for cutting - DEC 125. 100% tool free connection to Ø 115 - 125 mm AG(V) 12, AGV 15 series and FUEL™ grinders except the flathead model, keyless depth adjustment from 5 - 28 mm. Guide to prevent twisting during cutting. Dust guard fits to the Milwaukee® M-Class cleaners with unique "click-system" adaptor supplied with the vacuum cleaner	✓	✓			4932430467	4002395381289
b.	Dust guard for surface conditioning - DEG 125. 100% tool free connection to Ø 125 mm AG(V) 12, AGV 15 series and FUEL™ grinders except the flathead model. Supplied with additional loop handle. Removable magnetic front cover to gain access to tight corners and edges when using a cup wheel. Dust guard fits to the Milwaukee® M-Class cleaners with unique "click-system" adaptor supplied with the vacuum cleaner. Includes replaceable brush 4931448429		✓			4932430468	4002395381296
c.	Dust guard for cutting - DEC 230. 100% tool free connection to Ø 180 - 230mm AG 22, keyless depth adjustment from 5 - 60mm. Solid steel cutting guide to prevent twisting during cutting and flexible cutting line indicator for plunge cuts. Dust guard fits to the Milwaukee® M-Class cleaners with unique "click-system" adaptor supplied with the vacuum cleaner.			✓	✓	4932459340	4058546010010
	Dust guard for cutting - DEC 230 K. 100% tool free connection to Ø 180 - 230mm AG21, AGV 22, AG 24, AGVK 24 and FUEL™ grinders. Does not fit to LAG's equipped with autobalancer. Keyless depth adjustment from 5 - 60mm. Solid steel cutting guide to prevent twisting during cutting and flexible cutting line indicator for plunge cuts. Dust guard fits to the Milwaukee® M-Class cleaners with unique "click-system" adaptor supplied with the vacuum cleaner.			✓	✓	4932459341	4058546010027



SYSTEM ATTACHMENTS - BANDSAWS

- Safety - Protects user from injuries by preventing any access to the blade
- Jobsite Armor™ durability - Proprietary composite material and crush zone barriers absorb impacts and protect the tool
- Protection from debris - Covers protect the blade track and the pulley wheels from debris entering the tool and affecting overall performance
- Tool-free installation and removal within second
- Extends life of blade by protecting it from external objects

BANDSAW COVERS

	Description	Article Number	EAN Code
a	Bandsaw Cover for HD18 BS	4932471458	4058546290863
b	Bandsaw Cover for M18 FBS85	4932472241	4058546326371
c	Bandsaw Cover for M18 CBS125 & BS 125	4932471459	4058546290870

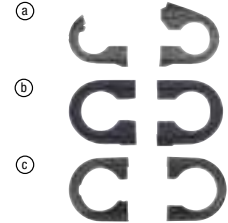

SYSTEM ATTACHMENTS - CIRCULAR SAWS

	Description	Fits Milwaukee Circular Saws	Article Number	EAN Code
a.	Dust absorption connector.	PCS 55	4932369282	4002395338412
b.	Spanner for removing saw blade.	CS 55,HK 46 N,SCS 65 Q,CS 75,PCS 55,HKS 75,HK 75 A,HKS 85,PMS 18	4932371469	4002395342181
c.	Parallel guide / fence	SCS 65 Q	49224146	045242181896
d.	Dust extraction hood for mitre saw, includes long hose, short hose, five lock fittings, 2x universal adaptors, extractor hose	MS 216 SB,M18 SMS216	4932430005	4002395376667



GUIDE RAILS AND ATTACHMENTS

		Description	Description	Article Number	EAN Code
a.	PSA-1	Guide rail clamps	Guide rail clamps compatible with GR 800, GR 1400 and GR 2700 guide rails	4932479068	4058546368623
b.	PSA-2	Guide rail joining bars	Guide rail joining bars for GR 800, GR 1400 and GR 2700 guide rails	4932479069	4058546368630
c.	PSA-3	Replacement guide rail splinter strip	Replacement guide rail splinter strip for GR 800, GR 1400 and GR 2700	4932479070	4058546368647
d.	PSA-4	Guide rail bag	Guide rail bag for GR 800 and GR 1400	4932479071	4058546368654
e.	PSA-5	Replacement low friction strip	Replacement low friction strip for GR 800, GR 1400 and GR 2700	4932479072	4058546368661
f.	GR 2700	2.7 m aluminium guide rail	Compatible with M18 FPS55, M18 FCSG66, M18 FMCS66, CS85 CBE, M18 FCS66GR3, M18 FR12, M18 FTR, M18 FTR8	4932479067	4058546368616
g.	GR 1400	1.4 m aluminium guide rail	Compatible with M18 FPS55, M18 FCSG66, M18 FMCS66, CS85 CBE, M18 FCS66GR3, M18 FR12, M18 FTR, M18 FTR8	4932479066	4058546368609
h.	GR 800	0.8 m aluminium guide rail	Compatible with M18 FPS55, M18 FCSG66, M18 FMCS66, CS85 CBE, M18 FCS66GR3, M18 FR12, M18 FTR, M18 FTR8	4932479065	4058546368593
i.	GR-KIT	1400 mm guiderails kit	2 x 1400 mm guiderails, supplied with bag and joining bars. Compatible with M18 FPS55, M18 FCSG66, M18 FMCS66, CS85 CBE, M18 FCS66GR3, M18 FR12, M18 FTR, M18 FTR8	4932480906	4058546411916



PLANER BLADES

	Description	Width (mm)	Fits planers	Article Number	EAN Code
a.	Tungsten carbide reversible blades. Two reversible blades, suitable for soft and hardwoods	56.1 mm	M12 BLP	4932493399	4058546482701
		82 mm	M18 BPH 500,H 750	4932273484	4002395300150
		102 mm	HB 750,HBE 800	4932316243	4002395300167

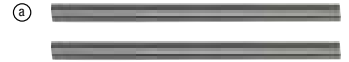

SYSTEM ATTACHMENTS - OUTDOOR PRODUCTS

SYSTEM ATTACHMENTS - CHAINSAWS

		Chain bar length (cm)	Chain gauge (mm/)	Chain pitch (mm/)	Article Number	EAN Code	
a.	Chainsaw chains	15 cm/ 6" saw chain 3/8" x 1.1mm	15 cm/ 6"	1.1/ 0.043"	9.5/ 3/8"	4932478427	4058546346188
		20 cm/ 8" saw chain 3/8" x 1.1mm	20 cm/ 8"	1.1/ 0.043"	9.5/ 3/8"	4932480176	4058546404611
		25 cm/ 10" Saw Chain 3/8" x 1.1mm	25 cm/ 10"	1.1/ 0.043"	9.5/ 3/8"	4932471329	4058546289577
		30 cm/ 12" Saw Chain 0.325" x 1.1mm	30 cm/ 12"	1.1/ 0.043"	8.3/ .325"	4932480177	4058546404628
		30 cm/ 12" Saw Chain 3/8" x 1.1mm	30 cm/ 12"	1.1/ 0.043"	9.5/ 3/8"	4932471385	4058546290139
		35 cm/ 14" Saw Chain 0.325" x 1.1mm	35 cm/ 14"	1.1/ 0.043"	8.3/ .325"	4932480178	4058546404635
		35 cm/ 14" Saw Chain 3/8" x 1.1mm	35 cm/ 14"	1.1/ 0.043"	9.525/ 3/8"	4932479820	4058546376147
		40 cm/ 16" Saw Chain 3/8" x 1.1mm	40 cm/ 16"	1.1/ 0.043"	9.5/ 3/8"	4932464873	4058546228187
		50 cm/ 20" Saw Chain 0.325" x 1.3mm	50 cm/ 20"	1.3/ 0.050"	8.3/ .325"	4932498791	4058546526603
b.	Chainsaw guide bars	15 cm/ 6" guide bar 3/8" x 1.1mm	15 cm / 6"	1.1/ 0.043"	9.5/ 3/8"	4932480168	4058546404536
		20 cm/ 8" guide bar 3/8" x 1.1mm	20 cm/ 8"	1.1/ 0.043"	9.5/ 3/8"	4932480169	4058546404543
		25 cm/ 10" Guide Bar 3/8" x 1.1mm	25 cm/ 10"	1.1/ 0.043"	9.5/ 3/8"	4932480170	4058546404550
		30 cm/ 12" Guide Bar 0.325" x 1.1mm	30 cm/ 12"	1.1/ 0.043"	8.3/ .325"	4932480171	4058546404567
		35 cm/ 14" Guide Bar 3/8" x 1.1mm	35 cm/ 14"	1.1/ 0.043"	9.5/ 3/8"	4932480172	4058546404574
		35 cm/ 14" Guide Bar 0.325" x 1.1mm	35 cm/ 14"	1.1/ 0.043"	8.3/ .325"	4932480173	4058546404581
		40 cm/ 16" Guide Bar 3/8" x 1.1mm	40 cm/ 16"	1.1/ 0.043"	9.5 / 3.8"	4932480174	4058546404598
		50 cm/ 20" Guide Bar 0.325" x 1.3mm	50 cm/ 20"	1.3/ 0.050"	8.3/ .325"	4932498790	4058546526597
c.	Chainsaw bags	Chainsaw bag for M18™ rear handle chainsaws			4932493810	4058546509705	
d.	Chainsaw bags	Chainsaw bag for M18™/M12™ hatchet pruning saws			4932493811	4058546509712	



SYSTEM ATTACHMENTS - LINE TRIMMERS

		Article Number	EAN Code
a.	Double shoulder harness for brush cutters	4932492849	4058546477202
b.	Single shoulder strap for line trimmers	4932492671	4058546475420
c.	Trimmer replacement head complete (includes spool and line 49162712)	49162710	045242493937
d.	Trimmer replacement spool (includes 49162711 line)	49162711	045242493920
e.	2 mm x 45 m trimmer line	49162712	045242493906
f.	2.4 mm x 76 m trimmer line	49162713	045242493913
g.	Auto feed trimmer replacement spool	49162714	045242006458
h.	Brush cutter replacement blade 4-tooth for M18 FOPH-BCA	4932481041	4058546413262
i.	Brush cutter replacement blade- 3-tooth for M18 F2BCU	4932498762	4058546526313
j.	Easy load trimmer head Gen II	4932480180	4058546404659



SYSTEM ATTACHMENTS - MOWERS

		Article Number	EAN Code
a.	Mower blade 18' / 46 cm	4932492106	4058546414733
	Mower blade 21' / 53 cm	4932479818	4058546376123
b.	High performance mower blade 18' / 46 cm	4932492107	4058546414740
	High performance mower blade 21' / 53 cm	4932479819	4058546376130
c.	Lawn mower cover 18' / 46 cm	4932492108	4058546414757
	Lawn mower cover 21' / 53 cm	4932479821	4058546376154

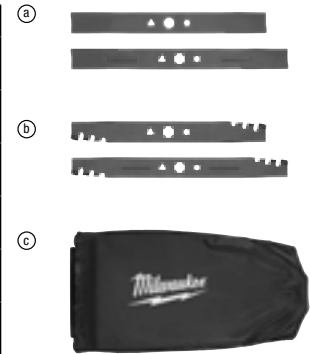

SYSTEM ATTACHMENTS - BLOWERS

		Article Number	EAN Code
a.	Single shoulder strap for M18 F2BL	4932492418	4058546417857
b.	Angled flare attachment for blowers	4932498513	4058546523824
c.	Blower nozzle attachment kit for blowers	4932498514	4058546523831
d.	Gutter attachment for handheld blowers	4932498512	4058546523817



SYSTEM ATTACHMENTS - OTHER OUTDOOR PRODUCTS

		Article Number	EAN Code
a.	Edger blade 203 mm	4932471330	4058546289584
b.	Holster for M12™ brushless pruning shear	4932492430	4058546417970
c.	Replacement blade for M12™ brushless pruning shear	4932492431	4058546417987
d.	Replacement blade for M18 BLTS	4932493557	4058546484286
e.	Bristle brush replacement drums for M18 FOPH	4932499150	4058546530198
f.	Rubber broom replacement drums for M18 FOPH	4932499151	4058546530204



CRIMPING DIES

Type	Form	Cable lug size (mm ²)	Imprint code	M18 HCCT, M18 ONEHCCT60			M18 HCCT109/42		
				Description	Article Number	EAN Code	Description	Article Number	EAN Code
a.	Hex	6	5	DIN22 Cu 6	4932464861	4058546228064	-	-	-
		10	6	DIN22 Cu 10	4932464862	4058546228071	-	-	-
		16	8	DIN22 Cu 16	4932451744	4002395277551	DIN13 Cu 16	4932459465	4058546011260
		25	10	DIN22 Cu 25	4932451745	4002395277568	DIN13 Cu 25	4932459466	4058546011277
		35	12	DIN22 Cu 35	4932451746	4002395277575	DIN13 Cu 35	4932459467	4058546011284
		50	14	DIN22 Cu 50	4932451747	4002395277582	DIN13 Cu 50	4932459468	4058546011291
		70	16	DIN22 Cu 70	4932451748	4002395277599	DIN13 Cu 70	4932459469	4058546011307
		95	18	DIN22 Cu 95	4932451749	4002395278206	DIN13 Cu 95	4932459470	4058546011314
		120	20	DIN22 Cu 120	4932451750	4002395278213	DIN13 Cu 120	4932459471	4058546011321
		150	22	DIN22 Cu 150	4932451751	4002395278220	DIN13 Cu 150	4932459472	4058546011338
		185	25	DIN22 Cu 185	4932451752	4002395278237	DIN13 Cu 185	4932459473	4058546011345
		240	28	DIN22 Cu 240	4932451753	4002395278244	DIN13 Cu 240	4932459474	4058546011352
		300	32	DIN22 Cu 300	4932451754	4002395278251	DIN13 Cu 300	4932459475	4058546011369



Type	Form	Cable lug size (mm ²)	Imprint code	M18 HCCT, M18 ONEHCCT60			M18 HCCT109/42		
				Description	Article Number	EAN Code	Description	Article Number	EAN Code
a.	Hex	6	6	R22 Cu 6	4932479391	4058546371852	-	-	-
		10	10	R22 Cu 10	4932479392	4058546371869	-	-	-
		16	16	R22 Cu 16	4932451755	4002395278268	R13 Cu 16	4932459494	4058546011550
		25	25	R22 Cu 25	4932451756	4002395278275	R13 Cu 25	4932459495	4058546011567
		35	35	R22 Cu 35	4932451757	4002395278282	R13 Cu 35	4932459496	4058546011574
		50	50	R22 Cu 50	4932451758	4002395278299	R13 Cu 50	4932459497	4058546011581
		70	70	R22 Cu 70	4932451759	4002395278909	R13 Cu 70	4932459498	4058546011598
		95	95	R22 Cu 95	4932451760	4002395278916	R13 Cu 95	4932459499	4058546011604
		120	120	R22 Cu 120	4932451761	4002395278923	R13 Cu 120	4932459500	4058546011611
		150	150	R22 Cu 150	4932451762	4002395278930	R13 Cu 150	4932459501	4058546011628
		185	185	R22 Cu 185	4932451763	4002395278947	R13 Cu 185	4932459502	4058546011635
		240	240	R22 Cu 240	4932451764	4002395278954	R13 Cu 240	4932459503	4058546011642
		300	300	R22 Cu 300	4932451765	4002395278961	R13 Cu 300	4932459504	4058546026769
400	400	-	-	-	R13 Cu 400	4932459505	4058546026776		



Type	Form	Cable lug size (mm ²)	Imprint code	M18 HCCT, M18 ONEHCCT60			M18 HCCT109/42		
				Description	Article Number	EAN Code	Description	Article Number	EAN Code
a.	Hex	10	-	R22 OU/KRF 10	4932479378	4058546371722	-	-	-
		16	-	R22 OU/KRF 16	4932479379	4058546371739	-	-	-
		25	-	R22 OU/KRF 25	4932479380	4058546371746	-	-	-
		35	-	R22 OU/KRF 35	4932479381	4058546371753	-	-	-
		50	-	R22 OU/KRF 50	4932479382	4058546371760	-	-	-
		70	-	R22 OU/KRF 70	4932479383	4058546371777	-	-	-
		95	-	R22 OU/KRF 95	4932479384	4058546371784	-	-	-
		120	-	R22 OU/KRF 120	4932479385	4058546371791	-	-	-
		150	-	R22 OU/KRF 150	4932479386	4058546371807	-	-	-
		185	-	R22 OU/KRF 185	4932479387	4058546371814	-	-	-
		240	-	R22 OU/KRF 240	4932479388	4058546371821	-	-	-
		300	-	R22 OU/KRF 300	4932479389	4058546371838	-	-	-



Type	Form	Cable lug size (mm ²)	Imprint code	M18 HCCT, M18 ONEHCCT60			M18 HCCT109/42		
				Description	Article Number	EAN Code	Description	Article Number	EAN Code
a.	Hex	16	16	NF22 Cu 16	4932451733	4002395276837	NF13 Cu 16	4932459453	4058546011147
		25	25	NF22 Cu 25	4932451734	4002395276844	NF13 Cu 25	4932459454	4058546011154
		35	35	NF22 Cu 35	4932451735	4002395276851	NF13 Cu 35	4932459455	4058546011161
		50	50	NF22 Cu 50	4932451736	4002395276868	NF13 Cu 50	4932459456	4058546011178
		70	70	NF22 Cu 70	4932451737	4002395276875	NF13 Cu 70	4932459457	4058546011185
		95	95	NF22 Cu 95	4932451738	4002395276882	NF13 Cu 95	4932459458	4058546011192
		120	120	NF22 Cu 120	4932451739	4002395276899	NF13 Cu 120	4932459459	4058546011208
		150	150	NF22 Cu 150	4932451740	4002395277506	NF13 Cu 150	4932459460	4058546011215
		185	185	NF22 Cu 185	4932451741	4002395277513	NF13 Cu 185	4932459461	4058546011222
		240	240	NF22 Cu 240	4932451742	4002395277520	NF13 Cu 240	4932459462	4058546011239
		300	300	NF22 Cu 300	4932451743	4002395277544	NF13 Cu 300	4932459463	4058546011246
		400	400	-	-	-	NF13 Cu 400	4932459464	4058546011253



Type	Form	Cable lug size (mm ²)	Imprint code	M18 HCCT, M18 ONEHCCT60			M18 HCCT109/42		
				Description	Article Number	EAN Code	Description	Article Number	EAN Code
a.	Hex	35/ 50	E140	NF22 E140	4932479394	4058546371883	NF13 E140-2x9	4932479686	4058546374808
		70/ 95/ 120	E173	NF22 E173	4932479395	4058546371890	NF13 E173-2x9	4932479687	4058546374815
		150/ 185/ 240	E235	NF22 E235	4932479396	4058546371906	NF13 E235-2x9	4932479688	4058546374822
		300	E260	NF22 E260	4932479397	4058546371913	NF13 E260-2x9	4932479689	4058546374839
	Hex	6 - 35	E140	NF22 E140	4932479394	4058546371883	NF13 E140-2x9	4932479686	4058546374808
		25 - 70	E173	NF22 E173	4932479395	4058546371890	NF13 E173-2x9	4932479687	4058546374815
		150	E215	NF22 E215	4932479398	4058546371920	NF13 E215-9	4932479690	4058546374846
		185 - 240	E280	-	-	-	NF13 E280-9	4932479691	4058546374853
	Hex	7.07	E54	NF22 E54	4932479399	4058546371937	NF13 E54-10	4932479692	4058546374860
		9.6/ 10.8/ 12.56	E68	NF22 E68	4932479400	4058546371944	NF13 E68-18	4932479693	4058546374877
		12.4/ 14.1/ 15.9/ 19.6	E72	NF22 E72	4932479401	4058546371951	NF13 E72-10	4932479694	4058546374884
		17.8/ 22/ 27.6	E83	NF22 E83	4932479402	4058546371968	NF13 E83-18	4932479695	4058546374891
		28.25/ 29.3/ 38.2/ 38.46	E100	NF22 E100	4932479403	4058546371975	NF13 E100-18	4932479696	4058546374907
48.3		E120	NF22 E120	4932479404	4058546371982	NF13 E120-18	4932479697	4058546374914	
70/ 95/ 120		E173	NF22 E173	4932479395	4058546371890	NF13 E173-2x9	4932479687	4058546374815	
116/ 146		E215	-	-	-	NF13 E215-18	4932479698	4058546374921	
Hex	22	E100	-	-	-	NF13 E100-18	4932479696	4058546374907	
	34.4	E120	-	-	-	NF13 E120-18	4932479697	4058546374914	
	43.1/ 54.6	E140	-	-	-	NF13 E140-2x9	4932479686	4058546374808	
	75.5/ 93.3	E173	-	-	-	NF13 E173-2x9	4932479687	4058546374815	
	117	E210	-	-	-	NF13 E210-10	4932479699	4058546374938	
	148	E230	-	-	-	NF13 E230-10	4932479700	4058546374945	
	228	E280	-	-	-	NF13 E280-5	4932479701	4058546374952	
	17.8/ 22/ 27.8/ 34.4	E120	-	-	-	NF13 E120-18	4932479697	4058546374914	
Hex	37.7/ 43.1/ 54.6	E140	-	-	-	NF13 E140-2x9	4932479686	4058546374808	
	58.9/ 80/ 69.3/ 88	E173	-	-	-	NF13 E173-2x9	4932479687	4058546374815	
	59.7/ 116.2	E210	-	-	-	NF13 E210-10	4932479699	4058546374938	
	75.7/ 147.1	E230	-	-	-	NF13 E230-10	4932479700	4058546374945	
	17.8/ 22/ 27.8/ 34.4/ 43.1	E54	-	-	-	NF13 E54-10	4932479692	4058546374860	
	37.7/ 54.6/ 69.3/ 88	E72	-	-	-	NF13 E72-10	4932479694	4058546374884	
	58.9/ 80	E100	-	-	-	NF13 E100-10	4932479702	4058546374969	
	59.7/ 116.2/ 75.5/ 147.1	E120	-	-	-	NF13 E120-9	4932479703	4058546374976	



		M18 HCCT, M18 ONEHCCT60					M18 HCCT109/42			
Type	Form	Cable lug size (mm ²)	Imprint code	Description	Article Number	EAN Code	Description	Article Number	EAN Code	
a.	Copper solderless terminals (DIN 46234, DIN 46230, DIN 46341)	Half round indent	16	-	Q22 CU 16	4932451766	4002395278978	Q13 CU 16	4932459477	4058546011383
			25	-	Q22 CU 25	4932451767	4002395278985	Q13 CU 25	4932459478	4058546011390
			35	-	Q22 CU 35	4932451768	4002395278992	Q13 CU 35	4932459479	4058546011406
			50	-	Q22 CU 50	4932451769	4002395279609	Q13 CU 50	4932459480	4058546011413
			70	-	Q22 CU 70	4932451770	4002395279616	Q13 CU 70	4932459481	4058546011420
			95	-	-	-	-	Q13 CU 95	4932459482	4058546011437



		M18 HCCT, M18 ONEHCCT60					M18 HCCT109/42			
Type	Form	Cable lug size (mm ²)	Imprint code	Description	Article Number	EAN Code	Description	Article Number	EAN Code	
a.	DIN Aluminium for aluminium compression cable lugs and connectors (DIN 46329, 46267 Part 1 and 2, DIN EN 50182)	Hex	10	-	DIN22 AL 10	4932479390	4058546371845	-	-	-
			16/25	-	DIN22 AL 16/25	4932451771	4002395279623	DIN13 AL 16/25	4932459506	4058546026783
			35	-	DIN22 AL 35	4932451772	4002395279630	DIN13 AL 35	4932459507	4058546026790
			50	-	DIN22 AL 50	4932451773	4002395279647	DIN13 AL 50	4932459508	4058546026806
			70	-	DIN22 AL 70	4932451774	4002395279654	DIN13 AL 70	4932459509	4058546026813
			95/120	-	DIN22 AL 95/120	4932451775	4002395279661	DIN13 AL 95/120	4932459510	4058546026820
			150	-	DIN22 AL 150	4932451776	4002395279678	DIN13 AL 150	4932459511	4058546026837
			185	-	DIN22 AL 185	4932451777	4002395279685	DIN13 AL 185	4932459512	4058546026844
			240	-	DIN22 AL 240	4932451778	4002395279692	DIN13 AL 240	4932459513	4058546026851
			300	-	DIN22 AL 300	4932451779	4002395279699	DIN13 AL 300	4932459514	4058546026868

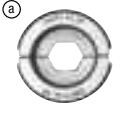

		M18 HCCT, M18 ONEHCCT60					M18 HCCT109/42			
Type	Form	Cable lug size (mm ²)	Imprint code	Description	Article Number	EAN Code	Description	Article Number	EAN Code	
a.	Copper tubular cable lugs and connectors like L series	Hex	16	8	L22 Cu 16	4932464487	4058546224325	L13 Cu 16	4932464500	4058546224455
			25	10	L22 Cu 25	4932464488	4058546224332	L13 Cu 25	4932464501	4058546224462
			35	12	L22 Cu 35	4932464489	4058546224349	L13 Cu 35	4932464502	4058546224479
			50	14	L22 Cu 50	4932464490	4058546224356	L13 Cu 50	4932464503	4058546224486
			70	16	L22 Cu 70	4932464491	4058546224363	L13 Cu 70	4932464504	4058546224493
			95	18	L22 Cu 95	4932464492	4058546224370	L13 Cu 95	4932464505	4058546224500
			120	20	L22 Cu 120	4932464493	4058546224387	L13 Cu 120	4932464506	4058546224517
			150	22	L22 Cu 150	4932464494	4058546224394	L13 Cu 150	4932464507	4058546224524
			185	25	L22 Cu 185	4932464495	4058546224401	L13 Cu 185	4932464508	4058546224531
			240	28	L22 Cu 240	4932464496	4058546224417	L13 Cu 240	4932464509	4058546224547
			300	32	L22 Cu 300	4932479393	4058546371876	L13 Cu 300	4932464510	4058546224554



		M18 HCCT, M18 ONEHCCT60					M18 HCCT109/42			
Type	Form	Cable lug size (mm ²)	Imprint code	Description	Article Number	EAN Code	Description	Article Number	EAN Code	
a.	Pre rounding of triangular shaped aluminium and copper conductors	Round	16	-	RU22 Cu/Al 16	4932451780	4002395276912	RU13 Cu/Al16	4932459483	4058546011444
			35/25	-	RU22 Cu35/AL25	4932451781	4002395276929	RU13 Cu35/AL25	4932459484	4058546011451
			50/35	-	RU22 Cu50/AL35	4932451782	4002395276936	RU13 Cu50/AL35	4932459485	4058546011468
			70/50	-	RU22 Cu70/AL50	4932451783	4002395276943	RU13 Cu70/AL50	4932459486	4058546011475
			95/70	-	RU22 Cu95/AL70	4932451784	4002395276950	RU13 Cu95/AL70	4932459487	4058546011482
			120/95	-	RU22 Cu120/AL95	4932451785	4002395276957	RU13 Cu120/AL95	4932459488	4058546011499
			150/120	-	RU22 Cu150/AL120	4932451786	4002395276974	RU13 Cu150/AL120	4932459489	4058546011506
			185/150	-	RU22 Cu185/AL150	4932451787	4002395276981	RU13 Cu185/AL150	4932459490	4058546011513
			240/185	-	RU22 Cu240/AL185	4932451788	4002395276998	RU13 Cu240/AL185	4932459491	4058546011529
			300/240	-	RU22 Cu300/AL240	4932451789	4002395277605	RU13 Cu300/AL240	4932459492	4058546011536



		M18 HCCT, M18 ONEHCCT60					M18 HCCT109/42			
Type	Form	Cable lug size (mm ²)	Imprint code	Description	Article Number	EAN Code	Description	Article Number	EAN Code	
a.	Ferruls	Trapezoid	16	-	-	-	-	AEH13 Cu 16	4932459515	4058546026875
			25	-	-	-	-	AEH13 Cu 25	4932459516	4058546026882
			35	-	-	-	-	AEH13 Cu 35	4932459517	4058546026899
			50	-	-	-	-	AEH13 Cu 50	4932459518	4058546026906
			70	-	-	-	-	AEH13 Cu 70	4932459519	4058546026913
			95	-	-	-	-	AEH13 Cu 95	4932459520	4058546026920
			120	-	-	-	-	AEH13 Cu 120	4932459521	4058546026936
			150	-	-	-	-	AEH13 Cu 150	4932459522	4058546026943
			185	-	-	-	-	AEH13 Cu 185	4932459523	4058546026950
240	-	-	-	-	AEH13 Cu 240	4932459524	4058546026967			



		M18 HCCT, M18 ONEHCCT60					M18 HCCT109/42			
Type	Form	Cable lug size (mm ²)	Imprint code	Description	Article Number	EAN Code	Description	Article Number	EAN Code	
a.	C taps	Oval	10	-	C22 Cu 10/C4	4932464863	4058546228088	-	-	-
			16	-	C22 Cu 16/C5	4932464864	4058546228095	C13 Cu 16	4932459525	4058546026974
			25	-	C22 Cu 25/C6	4932464865	4058546228101	C13 Cu 25	4932459526	4058546026981
			35	-	C22 Cu 35/C7	4932464866	4058546228118	C13 Cu 35	4932459527	4058546026998
			50	-	-	-	-	C13 Cu 50	4932459528	4058546027005
			70	-	-	-	-	C13 Cu 70	4932459529	4058546027012
			10	-	-	-	-	C13 Cu 10	4932459530	4058546027025
			10-35	-	-	-	-	C13 Cu 10-35	4932459531	4058546027032
			25-50	-	-	-	-	C13 Cu 25-50	4932459532	4058546027049
			35-70	-	-	-	-	C13 Cu 35-70	4932459533	4058546027056



		M18 HCCT, M18 ONEHCCT60					M18 HCCT109/42			
Type	Form	Cable lug size (mm ²)	Imprint code	Description	Article Number	EAN Code	Description	Article Number	EAN Code	
a.	H clamps	Oval	70	-	-	-	-	HAH13 Cu 70	4932459534	4058546027063
			95	-	-	-	-	HAH13 Cu 95	4932459535	4058546027070
			120	-	-	-	-	HAH13 Cu 120	4932459536	4058546027087



		M18 HCCT, M18 ONEHCCT60					M18 HCCT109/42			
Type	Form	Cable lug size (mm ²)	Imprint code	Description	Article Number	EAN Code	Description	Article Number	EAN Code	
a.	Double press cable shoes	Oval	2x50	-	-	-	-	DP13 Cu 2x50	4932459537	4058546027094
			2x70	-	-	-	-	DP13 Cu 2x70	4932459538	4058546027100
			2x95	-	-	-	-	DP13 Cu 2x95	4932459539	4058546027117



		M18 HCCT, M18 ONEHCCT60			M18 HCCT109/42		
Type	Form	Contents	Article Number	EAN Code	Contents	Article Number	EAN Code
a.	Die kits	Die storage box incl. 11 dies - 16, 25, 35, 50, 70, 95, 120, 150, 185, 240 & 300 mm ²	4932471997	4058546298968	Die storage box incl. 11 dies - 16, 25, 35, 50, 70, 95, 120, 150, 185, 240 & 300 mm ²	4932472000	4058546323967
		Die storage box incl. 9 dies - 16/25, 35, 50, 70, 95/120, 150, 185, 240 & 300 mm ²	4932471998	4058546298975	Die storage box incl. 9 dies - 16/25, 35, 50, 70, 95/120, 150, 185, 240 & 300 mm ²	4932472001	4058546323974
		Die storage box incl. 11 dies - 16, 25, 35, 50, 70, 95, 120, 150, 185, 240 & 300 mm ²	4932471999	4058546298982	Die storage box incl. 11 dies - 16, 25, 35, 50, 70, 95, 120, 150, 185, 240 & 300 mm ²	4932472002	4058546323981
b.	Box for crimping dies	Crimping die box for M18 HCCT crimper (dies to be bought separately)	4932459339	4058546010003	Crimping die box for M18 HCCT109/42 crimper (dies to be bought separately)	4932464211	4058546221560

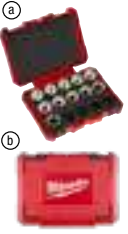

SYSTEM ATTACHMENTS - PIPE CUTTERS

	Description	Article Number	EAN Code
a	Pipe cutter wheels. Suitable for copper pipe. Not suitable for plastic or stainless steel pipe	48380010	045242159710
b	Cable cutter blade for C12 PC	4932430070	4002395377312
c	PEX cutter blade for C12 PPC	4931441978	4002395179268
d	Wheels for M12™ RAPTOR™ pipe cutter stainless steel (M12 PCSS) (2pc)	4932479243	4058546370374
e	Wheels for M12™ RAPTORXL™ pipe cutter stainless steel (M12 PCCS54)	4932498665	4058546525347



SYSTEM ATTACHMENTS - CABLE CUTTERS

	Description	Description	Article Number	EAN Code
a.	ACSR Aluminium steel reinforced cable cutting jaw including blades	Cable cutter jaw and blade set for cutting aluminium-steel transmission cable. ACSS-aluminium conductor steel supported cable and ACSR-aluminium conductor steel reinforced cable i.e. 94-AL1 / 15-ST1A (EN 50182). Not suitable for armoured cable or steel rods. Max. cutting Ø22.5 mm	49162773	045242350070
	ACSR Aluminium steel reinforced cable cutting blades	Replacement cable cutter blades for ACSR-jaw. Not suitable for armoured cable or steel rods.	48440412	045242355235
b.	Cu/Al standard copper & aluminium cable cutting jaw including blades	Cable cutter jaw and blade set for cutting copper/aluminium. Copper/aluminium standard stranded cable up to 4 x 50 mm ² , 1 x 500 mm ² in aluminium and 1 x 400 mm ² in copper. Not suitable for fine stranded/highly flexible cable. Max. cutting Ø35 mm	4932430839	4002395385010
	Cu/Al standard copper & aluminium cable cutting blades	Cu/Al standard copper & aluminium cable cutting blades. The blades fit for the Cu/Al cutting jaws for M18HCC & ONEHCC cutters + M18 HCCT crimper cutting jaw	4932464498	4058546224431
c.	FSW fine stranded wire cutting jaw including blades	Cable cutter jaw and blades for class 5 fine stranded wire and class 6 finest stranded wire according to IEC 60228/DIN VDE 0295 standards. Also suitable for high flexible data- and telecom cable. Not suitable for thick stranded cables. Max. cutting Ø35 mm	49162778	045242505722
	FSW fine stranded wire cutting blades	FSW fine stranded wire cutting blade	48442778	045242505739
d.	EHS guy wire/steel wire cutting jaw including blades	Cutting jaw and blades for EHS grade guy wire, stay wire & steel wire according to DIN48201/3 guy wire of grade ST1/ST2/ST3. Not suitable for fine stranded steel ropes. Max. cutting Ø15 mm	49162777	045242505449
	EHS guy wire/steel wire cutting blades	EHS guy wire/steel wire cutting blades	48442777	045242505456
e.	Armored cable cutting Jaw for M18 HCC	Armored cable cutting Jaw for M18 HCC	4932464867	4058546228125
	Replacement SWA blade for M18 HCC	Replacement SWA blade for M18 HCC	4932464868	4058546228132
f.	Replacement blade for M18 HCC125/ M18 HSFC125	Latch replacement blade for M18 HCC125/ M18 HSFC125	4932492423	4058546417901
		Moving ram replacement blade for M18 HCC125/ M18 HSFC125	4932492424	4058546417918
g.	Grounding kit for M18 HSFC125	Grounding kit for M18 HSFC125	4932492425	4058546417925



SYSTEM ATTACHMENTS - THREADED ROD CUTTER

	Description	Article Number	EAN Code
a.	Dies for M18™ BLTRC threaded rod cutter	4932471372	4058546290009



SYSTEM ATTACHMENTS - STRUT SHEAR

	Description	Article Number	EAN Code
a.	Strut shear die set 22 x 41 mm	49160078	045242821914
	Strut shear die set 41 x 41 mm	49160158	045242821891
	Strut shear die set 21 x 41 mm	49161316	045242821907
b.	Strut shear combination die set 21 x 41	49161513	045242821921
	Strut shear combination die set 22 x 41	49161578	045242821938



SYSTEM ATTACHMENTS - M18 FUEL™ FISH TAPES

	Description	Article Number	EAN Code
a.	Steel fish drums		
	36 m x 3 mm steel fish drum	48445176	4058546326432
	72 m x 3 mm steel fish drum	48445178	4058546326449
b.	Non-conductive drums		
	30 m non-conductive polyester drum	48445195	4058546326463
	60 m non-conductive polyester drum	48445197	4058546326470



SYSTEM ATTACHMENTS - HYDRAULIC KNOCKOUT PUNCH

- Suitable for mild steel and aluminium up to a thickness of 3 mm.
- Also suitable for stainless steel max. 2.5 mm.

	Description	Diameter (mm)	Article Number	EAN Code		Description	Diameter (mm)	Article Number	EAN Code
a.	Punch M16	16.2	4932430841	4002395385034		Die M16	16.2	4932430913	4002395385751
	Punch PG16	22.5	4932430843	4002395385058		Die PG16	22.5	4932430915	4002395385775
	Punch M20	20.4	4932430842	4002395385041		Die M20	20.4	4932430914	4002395385768
	Punch PG21	28.3	4932430845	4002395385072		Die PG21	28.3	4932430917	4002395385799
	Punch M25	25.4	4932430844	4002395385065		Die M25	25.4	4932430916	4002395385782
	Punch M32	32.5	4932430846	4002395385089		Die M32	32.5	4932430918	4002395385805
	Punch M40	40.5	4932430847	4002395385096		Die M40	40.5	4932430919	4002395385812
	Punch M50	50.5	4932430848	4002395385102		Die M50	50.5	4932430920	4002395385829
	Punch M63	63.5	4932430849	4002395385119		Die M63	63.5	4932430921	4002395385836
<ul style="list-style-type: none"> ◦ Draw stud bolt 49162680 (for 16.2 and 20.4 mm) Ø 11,1 mm: requires pre-drilling with Ø 11.3 - 11.5 mm drill bit / step drill. 									
b.	Draw bolt 11.1 mm (7/16)	Draw stud bolt 49162680 (for 16.2 and 20.4 mm) Ø 11,1 mm: requires pre-drilling with Ø 11.3 - 11.5 mm drill bit / step drill.				49162680	045242311774		
c.	Draw bolt 19 mm (3/4)	Draw stud bolt 49162681 Ø 19 mm: requires pre-drilling with Ø 19.5 - 20 mm drill bit / step drill.				49162681	045242311781		



SYSTEM ATTACHMENTS - HYDRAULIC PUMP

	Description	Features	Article Number	EAN Code
a.	1.8 m extension cord for M18 HUP controller	<ul style="list-style-type: none"> ◦ Compatible with M18™ FORCE LOGIC™ hydraulic pump ◦ IP 67 ingress protection for reliable use in the elements ◦ Male-female connectors for interconnectable extension up to 7.3 m of length 	49122775	4058546326487
b.	Bucket hanger for M18 HUP700	<ul style="list-style-type: none"> ◦ Compatible with M18™ FORCE LOGIC™ hydraulic pump ◦ Extendable bar & rubber bumpers allow for use with most existing buckets & steel baskets ◦ Symmetrical lift ring design enable use from both sides of the hanger 	49122776	045242535231
c.	Replacement oil M18 HUP700	<ul style="list-style-type: none"> ◦ 1 Liter accessory oil for M18™ FORCE LOGIC™ HUP700 hydraulic pump ◦ Ensures full performance and reliable use in extreme environmental conditions from -18°C to 50°C 	4932472004	4058546324001



SYSTEM ATTACHMENTS - EXPANSION TOOLS

EXPANDER HEADS

		Pipe diameter (mm)	Pipe wall thickness (mm)	Pipe pressure (bar)	Suitable	Article Number	EAN Code
a.	PXPH 9.9 - 144/8	9.9	1.1	4/8	M12, M18	4932430102	4002395377633
	PXPH 12l -14	12	1.7/ 1.8/ 2	6-10	M12, M18	4932352716	4002395373741
	PXPH 15N -14	14 / 15	2.5	6-10	M12, M18	4932352727	4002395373857
	PXPH 16l - 1406	16	1.5/ 1.8	6	M12, M18	4932430103	4002395377640
	PXPH 16l - 14	16	1.8/ 2.0/ 2.2	10	M12, M18	4932352717	4002395373758
	PXPH 18N - 14	17 / 18	2.5	6-10	M12, M18	4932352728	4002395373864
	PXPH 20l - 1406	20	1.9/ 2.0/ 2.3	6, (8 bar - Ø 2.3 mm)	M12, M18	4932352718	4002395373765
	PXPH 20l - 1410	20	2.8	10	M12, M18	4932352719	4002395373772
	PXPH 20l - 2506	20	1.9/ 2.0/ 2.3	6, (8 bar - Ø 2.3 mm)	M18	4932352733	4002395373918
	PXPH 20l - 2510	20	2.8	10	M18	4932352748	4002395374069
	PXPH 22N - 14	22	3	6-10	M12, M18	4932352729	4002395373871
	PXPH 25l - 1406	25	2.3	6	M12, M18	4932352720	4002395373789
	PXPH 25l - 1410	25	3.5	10	M12, M18	4932352721	4002395373796
	PXPH 25l - 2506	25	2.3	6	M18	4932352722	4002395373802
	PXPH 25l - 2510	25	3.5	10	M18	4932352749	4002395374076
	PXPH 28N - 14	28	4	6-10	M12, M18	4932352730	4002395373888
	PXPH 32l - 1406	32	2.9	6	M12, M18	4932352723	4002395373819
	PXPH 32l - 25	32	2.9/ 4.4	6-10	M18	4932352724	4002395373826
	PXPH 40l - 2506	40	3.7	6	M18	4932352725	4002395373833
	PXPH 40l - 2510	40	5.5	10	M18 FPXP	4932479581	4058546373757
PXPH 40l - 5606	40	3.7	6-10	M18 BLPXPL	4932451396	4002395160884	
PXPH 50l - 25	50	4.6/ 6.9	6-10	M18 FPXP	4932479582	4058546373764	
PXPH 50l - 5606	50	4.6	6-10	M18 BLPXPL	4932451397	4002395160891	
PXPH 63l - 5606	63	5.8	6-10	M18 BLPXPL	4932451398	4002395158102	
PXPH 75l - 5606	75	6.8	6-10	M18 BLPXPL	4932451399	4002395158119	
b.	Grease				For lubrication of cone and expander heads.	4932352726	4002395373840
	Grease expander heads 40/50 mm				For lubrication of M18 FPXP cone and 40/50 mm expander heads.	4932479835	4058546376291



RAPID SEAL™ EXPANDER HEADS

		Pipe diameter (mm)	Pipe wall thickness (mm)	Pipe pressure (bar)	Suitable	Article Number	EAN Code
a.	FPXPH9.9l-14	9.9	1.1	4-8	M12, M18	4932472150	4058546325466
	FPXPH16l-14	16	1.5/ 1.8/ 2.0/ 2.2	6-10	M12, M18	4932472151	4058546325473
	FPXPH20l-1406	20	1.9/ 2.0/ 2.3	6-8	M12, M18	4932472152	4058546325480
	FPXPH20l-1410	20	2.8	10	M12, M18	4932472153	4058546325497
	FPXPH25l-1406	25	2.3	6	M12, M18	4932472271	4058546339173
	FPXPH25l-1410	25	3.5	10	M12, M18	4932472272	4058546339180
	FPXPH32l-1406	32	2.9	6	M12, M18	4932472273	4058546339197



SYSTEM ATTACHMENTS - CAULK GUNS

	Description	Fits Milwaukee Caulk Guns	Article Number	EAN Code
a.	310 ml standard carriage. Accepts all standard 250 ml and 310 ml tubes/cartridges Includes plunger rod assembly (4932352937), piston for carriage assemblies and a feed screw (44700330)	C18 PCG	48081076	045242263127
b.	310 ml standard carriage. Accepts all standard 250 ml and 310 ml tubes/cartridges Includes plunger rod assembly (4932430099), piston for carriage assemblies and a feed screw (44700330)	C12 PCG	48080900	045242286355
c.	310 ml aluminium sausage tube barrel. Accepts standard 310 ml "sausage style" material packs and 380 ml cartridges. Requires plunger rod 49520660	PCG 14 / 300,PCG 14 / 600	48081085	045242089246
d.	400 ml aluminium sausage tube barrel. Accepts standard 400 ml "sausage style" material packs (includes 2 end cups). Requires plunger rod (48091090) and piston (44700375)	C18 PCG,C12 PCG	4932352844	4002395375028
e.	600 ml aluminium sausage tube barrel. Accepts standard 600 ml "sausage style" material packs (includes 2 end cups). Requires plunger rod (48091091) and piston (44700375)	C18 PCG,C12 PCG	4932352845	4002395375035
f.	400 ml transparent sausage tube barrel. Accepts standard 400 ml "sausage style" material packs (includes 2 end cups). Requires plunger rod (48091090) and piston (44700375)	C18 PCG,C12 PCG	4932352842	4002395375004
g.	600 ml transparent sausage tube barrel. Accepts standard 600 ml "sausage style" material packs (includes 2 end cups). Requires plunger rod (48091091) and piston (44700375)	C18 PCG,C12 PCG	4932352843	4002395375011
h.	Plunger rod assembly for 310 ml cartridges. For use with: 48081076 310 ml standard carriage	C18 PCG	4932352937	4002395375950
i.	Plunger rod assembly for 310 ml carriage. For use with: 48080900 310 ml standard carriage	C12 PCG	4932430099	4002395377602
j.	Plunger rod short (340 mm long). For use with: 48081075 carriage and 48081085 "sausage style" barrel	PCG 14 / 300,PCG 14 / 600	49520600	045242190201
k.	Plunger rod assembly for 400 ml sausage tube barrel. For use with: 4932352844 400 ml aluminium sausage tube barrel. 4932352842 400 ml transparent sausage tube barrel	C18 PCG	48091090	045242263158
l.	Plunger rod assembly for 400 ml sausage tube barrel. For use with: 4932352844 400 ml aluminium sausage tube barrel. 4932352842 400 ml transparent sausage tube barrel	C12 PCG	4932430100	4002395377619
m.	Plunger rod assembly for 600 ml sausage tube barrel. For use with: 4932352845 600 ml aluminium sausage tube barrel. 4932352843 600 ml transparent sausage tube barrel	C18 PCG	48091091	045242263165
n.	Plunger rod assembly for 600 ml sausage tube barrel. For use with: 4932352845 600 ml aluminium sausage tube barrel. 4932352843 600 ml transparent sausage tube barrel	C12 PCG	4932430101	4002395377626
o.	Piston for carriage assemblies	C18 PCG,C12 PCG	44700330	045242260928
p.	Piston for sausage tube barrels	C18 PCG,C12 PCG	44700375	045242277438
q.	Replacement nozzle	PCG 14 / 300,PCG 14 / 600,C18 PCG,C12 PCG	45760525	4002395775323



SYSTEM ATTACHMENTS - ELECTRICAL TEST & MEASURING

	Description	Article Number	EAN Code
a.	Electrical test probes (max. 1000 Volts/ 10 Amps) heads 125 mm long	49771004	045242238965
b.	Electrical alligator clips (max. 1000 Volts/ 10 Amps)	49771005	045242238972



SYSTEM ATTACHMENTS - HEATED JACKETS

- M18™ USB Power Source - M18™ USB PS HJ. Powers the jacket on M18™ battery packs. USB charging port for MP3 player, mobile phone, digital camera, GPS.
- 12 V Car Plug - 12 V CP HJ. Powers the jacket on any 12 V cigarette style outlet.

	Description	Article Number	EAN Code
a.	M18™ 2.1A USB controller (M18 USB PS HJ2)	4932471597	4058546294960
b.	M12™ car plug (12 V CP HJ)	4932430085	4002395377466



ONE-KEY™ BLUETOOTH® TRACKING TAG

- Track with any item in your MILWAUKEE® ONE-KEY™ inventory. Simply pair the TICK™ with your chosen item and leverage ONE-KEY™ integrated tool tracking to locate your missing product
- Fully compatible with all ONE-KEY™ integrated tool tracking and inventory management features
- IP68 - withstands toughest jobsite conditions
- Withstands temperatures from +60 °C to -20 °C
- 3-year run time with built-in non-replaceable battery, eliminates the need to stock batteries
- Identify a specific item or find an item, even if it cannot be visibly seen, with the new built-in speaker
- Up to 90 m beacon range
- 5 seconds duty cycles
- NFC allows you to pull data to troubleshoot
- The QR code allows for 2 step activation, tracking when Bluetooth® isn't working and quickly identify specific item within the ONE-KEY™ software
- The accelerometer will alert you if your item has been in use or is moved from where it belongs
- Solid, one piece, construction makes for a stronger, more durable product

	Description	Article Number	EAN Code
a.	MILWAUKEE® ONE-KEY™ Bluetooth® tracking tag - BTT	4933478640	4058546348335
b.	MILWAUKEE® ONE-KEY™ Bluetooth® tracking tag - BTT - 10 pc	4933478643	4058546348366

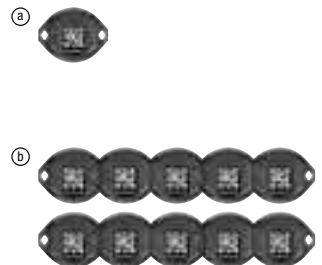

SYSTEM ATTACHMENTS - ROUTERS

	Description	Article Number	EAN Code
a.	TRB-1 Trim router offset base attachment, for trimming close to walls	4932471946	4058546298456
b.	TRB-2 Trim router offset base attachment for M18 FTR8	4932493596	4058546484675
c.	RCA-1 Quarter inch collet and nut for M18 FTR8	4932479425	4058546372194
d.	TRA-2 Plunge base for M18 FTR and M18 FTR8	4932480544	4058546408299
e.	RBA-1 12 mm router plunge base to be used with M18 FR12	4932493307	4058546481780
f.	RBA-2 Router guide rail adaptor attaches the M18 FR12 router to the current MILWAUKEE® guide rails	4932493306	4058546481773
g.	RC600 6 mm collet and nut for M18 FR12	4932493912	4058546510725
	RC635 6.35 mm (1/4") collet and nut for M18 FR12 router	4932493913	4058546510732
	RC800 8 mm collet and nut for M18 FR12 router	4932493914	4058546510749
	RC1200 12 mm collet and nut for M18 FR12 router	4932493915	4058546510756
	RC1250 12.5 mm (1/2") collet and nut for M18 FR12 router	4932493916	4058546510763
h.	Screw clamp (single piece) for stationary use of routers when used with flexible shaft (2 pcs required)	4932367730	4002395338566

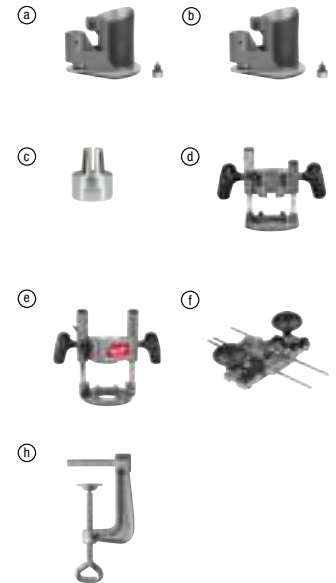

SYSTEM ATTACHMENTS - INSPECTION CAMERAS

- All extension cables are water splash and dust proof.
- Extensions are attached between the base camera unit and standard supplied camera cable.

	Description	Cable length (m)	Cable diameter (mm)	Fits Milwaukee Inspection Cameras	Article Number	EAN Code
a.	Cable extension: Up to a maximum of 3 extensions can be fixed together	0.9	17	C12 IC	48530110	045242157747
	Cable extension: Up to a maximum of 5 extensions can be fixed together	0.9	17	C12 AVD, C12 AVA	48530141	045242216529
	Replacement analog camera cable	0.9	9.5	C12 AVD, C12 AVA	4931419517	4002395828234
	1m replacement cable camera for the M-spector camera	1	12	M12 IC AV3	48530150	045242344208
	3m replacement cable camera for the M-spector camera	3	12	M12 IC AV3	48530151	045242344222
b.	1 m articulating cable	1	12	M12 IC AV3	48530155	045242344215
c.	Skid set for M18™SIC36	-	-	M18 SIC36	4931473616	4058546354923
d.	Skid set for M18™SIC60	-	-	M18 SIC60	4931473638	4058546355142
e.	Grounding kit for M18™SISH	-	-	M18 SISH	4931473526	4058546354022
f.	23 m replacement cable with 8 mm reception for M18™ high speed flexible shaft machine	23	-	-	4932480723	4058546410087
g.	5.0 mm replacement camera for M12™ automotive technician borescope	0.9	9.5	C12 AVD, C12 AVA	4932492938	4058546478094
h.	10 mm camera head - 3 m inspection camera for M12™ sewer inspection monitor	3	6	M12 SIM	4932498227	4058546520960
	10 mm camera head - 1.2 m inspection camera for M12™ sewer inspection monitor	1.2	6	M12 SIM	4932498228	4058546520977

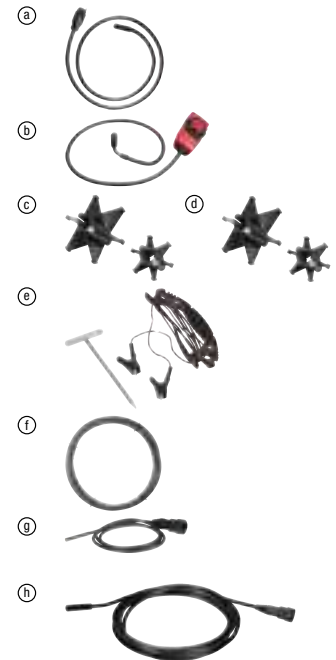

SYSTEM ATTACHMENTS - PIPE STAND

	Description	Article Number	EAN Code
a.	MILWAUKEE® pipe stand replaceable jaws	4932478923	4058546362058
	MILWAUKEE® pipe stand neoprene jaws	4932478924	4058546362065
b.	MILWAUKEE® pipe stand stainless steel jaws	4932478925	4058546362072
c.	MILWAUKEE® pipe stand removeable shelf	4932478926	4058546362089

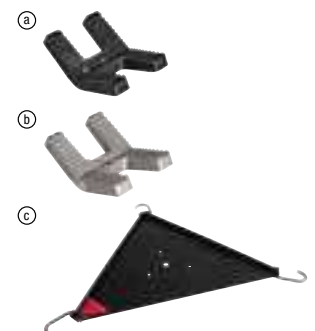

SYSTEM ATTACHMENTS - PASS-THROUGH RATCHET

	Description	Article Number	EAN Code	
a.	INSIDER™ pass-through ratchet socket 8 mm (pass-through)	4932492855	4058546477264	
	INSIDER™ pass-through ratchet socket 9 mm (pass-through)	4932492856	4058546477271	
	INSIDER™ pass-through ratchet socket 10 mm (pass-through)	4932492857	4058546477288	
	INSIDER™ pass-through ratchet socket 11 mm (pass-through)	4932492858	4058546477295	
	INSIDER™ pass-through ratchet socket 12 mm (pass-through)	4932492859	4058546477301	
	INSIDER™ pass-through ratchet socket 13 mm (pass-through)	4932492860	4058546477318	
	INSIDER™ pass-through ratchet socket 14 mm (pass-through)	4932492861	4058546477325	
	INSIDER™ pass-through ratchet socket 15 mm (pass-through)	4932492862	4058546477332	
b.	INSIDER™ pass-through ratchet socket 16 mm	4932492863	4058546477349	
	INSIDER™ pass-through ratchet socket 17 mm	4932492864	4058546477356	
	INSIDER™ pass-through ratchet socket 18 mm	4932492865	4058546477363	
	INSIDER™ pass-through ratchet socket 19 mm	4932492866	4058546477370	
	INSIDER™ pass-through ratchet socket 21 mm	4932492867	4058546477387	
c.	INSIDER™ pass-through ratchet anvil adapters	INSIDER™ pass-through ratchet 1/4" anvil adapter	4932499408	4058546565725
	INSIDER™ pass-through ratchet 3/8" anvil adapter	4932499409	4058546565732	
	INSIDER™ pass-through ratchet 1/2" anvil adapter	4932499410	4058546565749	
d.	INSIDER™ pass-through ratchet Hex bit holders	INSIDER™ pass-through ratchet 1/4" Hex bit holder	4932492871	4058546477424

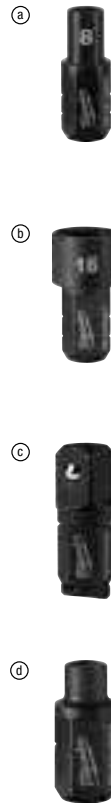

M12™ / M18™ DUST ABSORPTION SYSTEM

Description	Fits MILWAUKEE® Dust Extractors	Pack quantity	Min. order quantity	Article Number	EAN Code
a. Drilling nozzle	M18 CDEX / M18/28 CPDEX, M12 DE	2	1	49902301	045242337279
b. Filter	M18 CDEX / M18/28 CPDEX, M12 DE	3	1	49902306	045242299454
c. Crevice nozzle	M12 DE	1	1	49902325*	045242297603
d. Filter set (3pc) Filter box, filter, box lid	M12 DE	3	1	49902340	045242299461
e. M18 & M28 Dustbox with filter box, filter	M18 CDEX / M18/28 CPDEX	4	1	49902342	045242341948
f. Dust thru-box to allow connection of the M12 DE to an independent dust extraction / vacuum cleaner. Outlet nozzle: Ø 37 mm outside / Ø 32 mm inside		1	1	4932430479	4002395381401
g. Drilling shroud - PHDE152		1	1	4932471990	4058546298890



SYSTEM ATTACHMENTS - DUST ABSORPTION

VACUUM CLEANERS

	Description	Fits MILWAUKEE® Dust Extractors	Article Number	EAN Code
a.	Extraction hose, anti static. 4 m long 36 mm diameter with tool adaptor	AS 300 ELCP,AS 500 ELCP,AS 300 EMAC	4932352311	4002395369706
	Universal adaptor Ø 35 / 33 / 27 mm	WDC 1400 A,AS 1,AS 2 C,AS 3 W,ASE 1400,ASM 1400	4932369282	4002395338412
	Extraction hose Ø 35 mm / 5 m	ASE 1400,ASM 1400	4932373626	4002395351534
b.	Metal push handle	AS 42 MAC,AS 30 MAC,AS 30 LAC	4932459691	4058546028633
c.	27 mm x 3.5 m hose attachment	AS2-250EM/H	4932498236	4058546521059
d.	PACKOUT™ compatible dust separator	M18 FPOVCL	4932498256	4058546521257

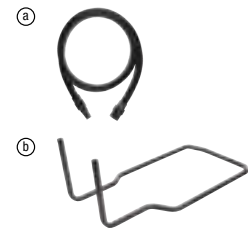

FILTER BAGS

	Description	Fits MILWAUKEE® Dust Extractors	Capacity (l)	Article Number	EAN Code
a.	Filter bags (5pc)	AS 250 ECP	25	4932352306	4002395369652
b.	Filter bags	AS 300 ELCP,AS 300 EMAC,AS 300 ELAC	30	4932352307	4002395369669
c.	Filter bags: 5 x plastic bags, 30 l	AS 250 ECP,AS 300 ELCP,AS 300 EMAC	30	4932352309	4002395369683
d.	Disposable bags 30 l	AS 42 MAC,AS 30 MAC,AS 30 LAC	30	4932459690	4058546028626
e.	Filter bags	AS 500 ELCP	50	4932352308	4002395369676
f.	Filter bags: 5 x plastic bags, 50 l	AS 500 ELCP	50	4932352310	4002395369690
g.	Fleece filter bags for AS 30/42	AS 30 LAC,AS 30 MAC,AS 42 MAC	30	4932459689	4058546028619
h.	Fleece filter bag (5pc)	M18 F2VC23L	23	4932479807	4058546376017
i.	Fleece bags (3pc)	M18 FPOVCL,M12 FVCL	3.5	4932478762	4058546360443



FILTER CARTRIDGES

	Description	Fits MILWAUKEE® Dust Extractors	Article Number	EAN Code
a.	Filter cartridges, 2pc	AS 300 EMAC,AS 300 ELAC	4932352305	4002395369645
b.	Filter cartridge	AS 250 ECP,AP 250 ECP	4932352303	4002395369621
c.	Filter cartridge	AS 300 ELCP,AS 500 ELCP,AS 2-250 ELCP	4932352304	4002395369638
d.	Flat folded polyester filter cartridge, 2 pcs	ASE 1400,ASM 1400	4932373623	4002395351510
e.	PTFE flat filter	AS 30 LAC,AS 42 MAC,AS 30 MAC	4932459687	4058546028596
f.	Motor cooling filter	AS 42 MAC,AS 30 MAC,AS 30 LAC	4932459688	4058546028602
g.	Wet filter universal	M12 FVCL,M18 FPOVCL,M18 VC2	4932478802	4058546360849
h.	Wet filter replacement	M18 F2VC23L	4932479806	4058546376000
i.	Dry HEPA filter universal replacement	M12 FVCL,M18 FPOVCL,M18 VC2	4932478754	4058546360368
j.	Dry HEPA filter replacement for M18 FCVL	M18 FCVL	4932478814	4058546360962
k.	Dry HEPA filter replacement	M18 F2VC23L	4932479805	4058546375997
l.	H-Class filter	AS2-350EH	4932498235	4058546521042



SYSTEM ATTACHMENTS - AIR TIP™ ATTACHMENTS

		Description	Features	Article Number	EAN Code
a.	AT-1	AIR-TIP™ dust collector	<ul style="list-style-type: none"> Funnel design to capture more debris Uses the vacuums suction to suck to walls, allowing for hands-free use Compatible with other wet/ dry vacuum brands with 32 mm, 47.5 mm, and 63.5 mm hose diameters Strong rubber seal 	4932498010	4058546511708
b.	AT-2	AIR-TIP™ 3-in-1 crevice and brush tool	<ul style="list-style-type: none"> Reversible and removeable 2-sided brush head Two-sided brush head has long/ soft bristles on one side, and short/ stiff bristles on the other Brush head slides and removes easily with two detent buttons 	4932498011	4058546511715
c.	AT-3	AIR-TIP™ 2-in-1 utility brush tool	<ul style="list-style-type: none"> Brush tool slides and locks into place Agitating brushes for easy debris removal Length 28.4 cm Compatible with other wet/ dry vacuum brands with 32 mm, 47.5 mm, and 63.5 mm hose diameters 	4932498012	4058546511722
d.	AT-4	AIR-TIP™ long reach flexible micro hose set	<ul style="list-style-type: none"> Five interchangeable micro hose lengths and diameters for many hard to reach spaces Can be used in a variety of spaces like automotive, HVAC, plumbing, light fixtures, condensate lines, and many more 	4932498013	4058546511739
e.	AT-5	AIR-TIP™ cross brush tool	<ul style="list-style-type: none"> Cross bristle design mitigates pushing debris away from the cleaning area Agitating brushes for easy debris removal Compatible with other wet/ dry vacuum brands with 32 mm, 47.5 mm, and 63.5 mm hose diameters Bristles will not mar or scratch surfaces 	4932498014	4058546511746
f.	AT-6	AIR-TIP™ swiveling palm brush	<ul style="list-style-type: none"> Swivels 360° Interchangeable bristle/ brush heads included Compatible with other wet/ dry vacuum brands with 32 mm, 47.5 mm, and 63.5 mm hose diameters 	4932498015	4058546511753
g.	AT-7	AIR-TIP™ pivoting extension wand	<ul style="list-style-type: none"> Strong detent mechanism Pivoting 90° joint allows for greater cleaning access overhead and below Compatible with other wet/ dry vacuum brands with 32 mm, 47.5 mm, and 63.5 mm hose diameters Can hold 32 mm accessories on the end of the tip 	4932498016	4058546511760
h.	AT-8	AIR-TIP™ rotating corner brush tool	<ul style="list-style-type: none"> 360° rotating brush head Agitating brushes for easy debris removal Compatible with other wet/ dry vacuum brands with 32 mm, 47.5 mm, and 63.5 mm hose diameters Corner shaped tip 	4932498017	4058546511777
i.	AT-9	AIR-TIP™ conduit line puller kit	<ul style="list-style-type: none"> Flexible rubber design to fit into small conduit boxes and tight areas Narrow ends and cross design stopper prevents line and bag from sucking into the vacuum Rubber cone seal 	4932498018	4058546511784
j.	AT-10	AIR-TIP™ low profile pivoting brush tool	<ul style="list-style-type: none"> Strong pivoting joint for use in multiple orientations 360° flat swiveling head Bristles will not mar or scratch surfaces Agitating brushes for easy debris removal 	4932498019	4058546511791
k.	AT-11	AIR-TIP™ magnetic utility nozzle	<ul style="list-style-type: none"> Black zinc coating prevents rust Optimised for handheld use Compatible with other wet/ dry vacuum brands with 32 mm, 47.5 mm, and 63.5 mm hose diameters 	4932498020	4058546511807
l.	AT-12	AIR-TIP™ 4-in-1 right angle cleaning tool	<ul style="list-style-type: none"> Gradual bend and right angle design can be used around pipes near walls and in a variety of tight access cleaning situations Compatible with other wet/ dry vacuum brands with 32 mm, 47.5 mm, and 63.5 mm hose diameters Tip holder stores the 4 included tips 	4932498021	4058546511814
m.	AT-13	AIR-TIP™ flexible long reach crevice tool	<ul style="list-style-type: none"> Flexible tool shaft can bend to reach into difficult areas 40 cm in overall length Compatible with other wet/ dry vacuum brands with 32 mm, 47.5 mm, and 63.5 mm hose diameters Durable and flexible rubber material 	4932498022	4058546511821
n.	AT-14	AIR-TIP™ non-marring utility nozzle kit	<ul style="list-style-type: none"> Specialised resin allows for each tip to be used on finished surfaces without marking up the area Compatible with other wet/ dry vacuum brands with 32 mm, 47.5 mm, and 63.5 mm hose diameters Non-marring edges indicated by the black surface on each tool 	4932498023	4058546511838
o.	AT-15	AIR-TIP™ claw utility nozzle with brushes	<ul style="list-style-type: none"> Ergonomic claw grips and integrated bristles allows for more cleaning leverage and agitation in the same application Agitating brushes for easy debris removal Compatible with other wet/ dry vacuum brands with 32 mm, 47.5 mm, and 63.5 mm hose diameters 	4932498024	4058546511845
p.	AT-16	AIR-TIP™ rocking utility nozzle with brushes	<ul style="list-style-type: none"> Easier to push and pull across surfaces Agitating brushes for easy debris removal Compatible with other wet/ dry vacuum brands with 32 mm, 47.5 mm, and 63.5 mm hose diameters Beveled design optimised for both forward and backward cleaning strokes 	4932498025	4058546511852
q.	M12 AUN	M12™ AIR-TIP™ utility nozzle	<ul style="list-style-type: none"> The M12™ powered utility nozzle is a great accessory that is designed to clean jobsite debris on short and medium hair carpeted surfaces The universal reception fits to all MILWAUKEE® M12™ and M18™ cordless vacs and covers most common hose sizes (Ø 31.8 mm, 47.6 mm and 63.5 mm) 	4932479461	4058546372552

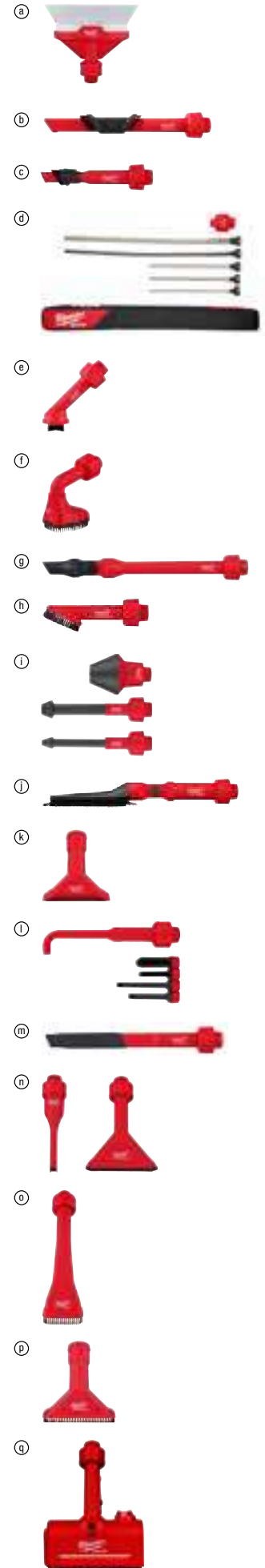

SYSTEM ATTACHMENTS - FLEXIBLE SHAFT MACHINE

		Name	Description	Fits Milwaukee flexible shaft machine	Article Number	EAN Code
a.	Lubrication oil for M18™ high speed flexible shaft machine	HSFSM-OIL	Lubrication oil for M18™ high speed flexible shaft machine	M18 HSFSM	4932480905	4058546411909
b.	23 m replacement cable with 8 mm reception for M18™ high speed flexible shaft machine	HSFSM-RC8	23 m replacement cable with 8 mm reception for M18™ high speed flexible shaft machine	M18 HSFSM	4932480723	4058546410087
c.	Standard chain for M18™ high speed flexible shaft machine	HSFSM-SC3240	32 - 40 mm standard chain for M18™ high speed flexible shaft machine	M18 HSFSM	4932480724	4058546410094
		HSFSM-SC50	50 mm standard chain for M18™ high speed flexible shaft machine	M18 HSFSM	4932480725	4058546410100
		HSFSM-SC75	75 mm standard chain for M18™ high speed flexible shaft machine	M18 HSFSM	4932480726	4058546410117
		HSFSM-SC110	110 mm standard chain for M18™ high speed flexible shaft machine	M18 HSFSM	4932480727	4058546410124
d.	Carbide chains for M18™ high speed flexible shaft machine	HSFSM-CC3240	32 - 40 mm carbide chain for M18™ high speed flexible shaft machine	M18 HSFSM	4932480728	4058546410131
		HSFSM-CC50	50 mm carbide chain for M18™ high speed flexible shaft machine	M18 HSFSM	4932480729	4058546410148
		HSFSM-CC75	75 mm carbide chain for M18™ high speed flexible shaft machine	M18 HSFSM	4932480730	4058546410155
		HSFSM-CC110	110 mm carbide chain for M18™ high speed flexible shaft machine	M18 HSFSM	4932480731	4058546410162
e.	Penetrating head for M18™ high speed flexible shaft machine	HSFSM-PH	Penetrating head for M18™ high speed flexible shaft machine	M18 HSFSM	4932480732	4058546410179



SYSTEM ATTACHMENTS - PORTABLE BATTERY EXTENSION

		Description	Article Number	EAN Code
a.	MXF PBET-24	MX FUEL™ portable battery extension tether 2.4 m with mock battery	4932498068	4058546512286



INTRODUCTION PAGES

GUARANTEE CONDITIONS	3
M12™ INSPECTION CAMERAS	77
M12 FUEL™ INTRODUCTION	46
M18™ INSPECTION CAMERAS	76
M18 FUEL™ INTRODUCTION	12
M18™ REDLITHIUM™ FORGE™ BATTERIES	13
M18™ REDLITHIUM™ FORGE™ RUN TIME DATA	14
MX FUEL™ FORGE™	8
MX FUEL™ INTRODUCTION	4
MX FUEL™ RUN TIME DATA	10
ONE-KEY™ INTRODUCTION	11
OPE TOOLS RUN TIME DATA	84 - 85
TRUEVIEW™ TECHNOLOGY	86

TOOLS 4 - 103

2200-40	VOLTAGE DETECTOR	68
2205-40	FORK METER FOR ELECTRICIANS	68
2212-20	AUTO VOLTAGE / CONTINUITY TESTER	68
2216-40	LIGHT COMMERCIAL MULTIMETER	68
2217-40	DIGITAL MULTIMETER	68
2225-20	NON CONTACT VOLTAGE DETECTOR WITH LASER THERMOMETER	68
2235-40	LIGHT COMMERCIAL CLAMP METER	68
2267-40	10:1 INFRARED TEMP-GUN™	68, 72
AG 10 EK	1000 W ANGLE GRINDER	98 - 99
AG 13 XSPD	1250 W ANGLE GRINDER WITH SLIM PADDLE SWITCH	98 - 99
AG 22	2200 W ANGLE GRINDER	98 - 99
AG 24	2400 W ANGLE GRINDER	98 - 99
AG 800 E	800 W ANGLE GRINDER	98 - 99
AG 800 EK	800 W ANGLE GRINDER WITH KEYLESS GUARD	98 - 99
AGS 15-125 C	1500 W GRINDER/SANDER	100
AGV 10 EK	1000 W ANGLE GRINDER WITH AVS	98 - 99
AGV 12	1200 W ANGLE GRINDER WITH AVS	98 - 99
AGV 12 DEC	1200 W ANGLE GRINDER WITH DUST MANAGEMENT (28 MM DOC)	97
AGV 12 DEG	1200 W ANGLE GRINDER WITH DUST MANAGEMENT	97
AGV 13	1250 W ANGLE GRINDER WITH AVS AND SLIDE SWITCH	98 - 99
AGV 13 XSPDE	1250 W ANGLE GRINDER WITH AVS AND SLIM PADDLE SWITCH	98 - 99
AGV 13 XSPDEB	1250 W BRAKING GRINDER WITH AVS AND PADDLE SWITCH	98 - 99
AGV 15	1550 W ANGLE GRINDER WITH AVS	98 - 99
AGV 15 DEC	1550 W ANGLE GRINDER WITH DUST MANAGEMENT (28 MM DOC)	97
AGV 15 DEG	1550 W ANGLE GRINDER WITH DUST MANAGEMENT	97
AGV 17	1750 W ANGLE GRINDER WITH AVS	98 - 99
AGV 17 INOX	1750 W LOW SPEED GRINDER WITH AVS	98 - 99
AGV 22	2200 W ANGLE GRINDER WITH AVS	98 - 99
AGV 24	2400 W ANGLE GRINDER WITH AVS	98 - 99
AGV 26	2600 W ANGLE GRINDER WITH AVS	98 - 99
AGVK 24	2400 W ANGLE GRINDER WITH AVS AND KICKBACK PROTECTION	98 - 99
AGVKB 24	2400 W ANGLE GRINDER WITH BRAKE, KICKBACK PROTECTION AND AVS	98 - 99
AGVM 24	2400 W ANGLE GRINDER WITH AVS AND KICKBACK PROTECTION	98 - 99
AGVM 26	2600 W ANGLE GRINDER WITH AVS AND KICKBACK PROTECTION	98 - 99
AIC2	ALKALINE INSPECTION CAMERA 2ND GEN	78
AP 12 E	1200 W POLISHER WITH ELECTRONIC VARIABLE SPEED	100
AP 14-2 200 E	1450 W POLISHER	100
AS 12 E	1200 W SANDER WITH ELECTRONIC VARIABLE SPEED	100
AS 2-250 ELCP	25 L L-CLASS DUST EXTRACTOR	102
AS 2-250EH	25 L H-CLASS DUST EXTRACTOR	102
AS 2-250EM	25 L M-CLASS DUST EXTRACTOR	102
AS 30 LAC	30 L L-CLASS DUST EXTRACTOR	102
AS 30 MAC	30 L M-CLASS DUST EXTRACTOR	102
AS 42 MAC	42 L M-CLASS DUST EXTRACTOR	102
BRT	BREAKER TROLLEY	96
BS 100 LE	4" (100 MM) BELT SANDER	102

BS 125	DEEP CUT BAND SAW	100
C12 C	M12™ CHARGER	93
C12 HZ	M12™ SUB COMPACT HACKZALL™	38, 56
C12 MT	M12™ SUB COMPACT MULTI-TOOL	38, 55
C12 PC	M12™ SUB COMPACT COPPER PIPE CUTTER	71
C12 PN	M12™ SUB COMPACT PALM NAILER	57
C12 PPC	M12™ SUB COMPACT PEX CUTTER	71
C12 PXP	M12™ SUB COMPACT UPONOR™ Q&E EXPANSION TOOL	73
C12 RAD	M12™ SUB COMPACT RIGHT ANGLE DRILL	47
C12 RT	M12™ SUB COMPACT ROTARY TOOL	54
C18 HZ	M18™ HACKZALL™	38, 39
C18 PCG/310	M18™ CAULK GUN WITH 310 ML CANISTER	29
C18 PCG/400	M18™ CAULK GUN WITH 400 ML TUBE	29
C18 PCG/600	M18™ CAULK GUN WITH 600 ML TUBE	29
C18 RAD	M18™ COMPACT RIGHT ANGLE DRILL	21
CHS 355	2300 W CHOPSAW	100
CLL	ALKALINE GREEN CROSS LINE LASER	62
CS 60	184 MM CIRCULAR SAW (61 MM DOC)	101
CS 85 CBE	235 MM CIRCULAR SAW (85 MM DOC)	101
CS 85 SB	235 MM CIRCULAR SAW (85 MM DOC)	101
DD 2-160 XE	2-SPEED DRY DIAMOND DRILL	96
DD 3-152	3-SPEED COMBI DIAMOND DRILL	96
DE 10 RX	630 W SINGLE HIGH SPEED ROTARY DRILL	100
DE 13 RP	630 W SINGLE SPEED ROTARY DRILL	96 - 97
DG 30 E	VARIABLE SPEED SINGLE HANDED DIE GRINDER	100
DG 7 E	LOW SPEED DIE GRINDER	100
DGL 30 E	VARIABLE SPEED 2-HANDED DIE GRINDER	100
DGL 34	SINGLE HIGH SPEED 2-HANDED DIE GRINDER	100
FL-LED	ALKALINE FLOOD LIGHT	91
FSPE 110 X	HEAVY DUTY BODY GRIP JIGSAW	101
HAC0850	8 KG CLASS SDS-MAX DRILLING AND BREAKING HAMMER	94 - 95
HD18 CS	M18™ 55 MM CIRCULAR SAW FOR WOOD AND PLASTIC	37, 38
HD18 PXP	M18™ UPONOR™ Q&E EXPANSION TOOL	73
HDE 13 RQX	950 W SINGLE SPEED ROTARY DRILL	96 - 97
HI-VIST	HIGH VISIBILITY LASER TARGET PLATE	63
HL-SF	ALKALINE SPOT FLOOD HEADLAMP	91
HL2-LED	ALKALINE SLIM HEADLAMP	91
IPL-LED	ALKALINE PEN LIGHT	91
IPWE 400 R	½" DRIVE IMPACT WRENCH	96
IPWE 520 R	¾" DRIVE IMPACT WRENCH	96
IR FFL	INTERNAL RECHARGEABLE FOLDING FLOOD LIGHT	91
IR FL	INTERNAL USB RECHARGEABLE FLASHLIGHT 500 LUMENS	91
IR HL	INTERNAL USB RECHARGEABLE HEADLAMP 450 LUMENS	91
IR PL	INTERNAL USB RECHARGEABLE PEN LIGHT 250 LUMENS	91
IRPSUOP2500	ROLL-ON 7200/ 3600 W 2.5 KWH POWER SUPPLY	8
ISHL-LED	ALKALINE INTRINSICALLY SAFE HEADLAMP	91
JSPE 135	HEAVY DUTY TOP HANDLE JIGSAW	101
K 1000 S	10 KG CLASS SDS-MAX BREAKING HAMMER	94 - 95
K 1528 H	16 KG CLASS 28 MM HEX BREAKING HAMMER	94 - 95
K 1530 H	16 KG CLASS 30 MM HEX BREAKING HAMMER	94 - 95
K 2628 H	25 KG CLASS 28 MM HEX BREAKING HAMMER	94 - 95
K 500 S	5 KG CLASS BREAKING HAMMER	94 - 95
K 540 S	5 KG CLASS DRILLING AND BREAKING HAMMER	94 - 95
K 545 S	5 KG CLASS DRILLING AND BREAKING HAMMER	94 - 95
K 750 S	7 KG CLASS DRILLING AND BREAKING HAMMER	94 - 95
K 900	10 KG CLASS BREAKING HAMMER	94 - 95
K 950	10 KG CLASS DRILLING AND BREAKING HAMMER	94 - 95
L4 B3	3.0 AH REDLITHIUM™ USB BATTERY	92
L4 BOLTHL	BOLT™ HEADLAMP 600 LUMENS USB RECHARGEABLE	90
L4 CLL	USB RECHARGEABLE GREEN CROSS LINE LASER	62
L4 CLLP	USB RECHARGEABLE GREEN CROSS LINE LASER WITH PLUMB POINTS	62
L4 FFL	USB RECHARGEABLE FOLDING FLOOD LIGHT	90
L4 FL	USB RECHARGEABLE POCKET FLOOD LIGHT	90
L4 FL2000	USB RECHARGEABLE FLASHLIGHT 2000 LUMENS	90
L4 FMLLED	USB RECHARGEABLE 800L FIXED FLASHLIGHT	90

TOOLS		4 - 103
L4 HBLB	USB RECHARGEABLE HEATED WORKSKIN™ BASE LAYER	60
L4 HL-VIS	USB RECHARGEABLE HI-VIS HEADLAMP	90
L4 HL2	USB RECHARGEABLE HEADLAMP 600 LUMENS	90
L4 HLRP	USB RECHARGEABLE HARD HAT HEADLAMP	90
L4 HSL	USB RECHARGEABLE HOT STICK LIGHT	67
L4 NL400	USB RECHARGEABLE NECK LIGHT 400 LUMENS	90
L4 PWL	USB RECHARGEABLE PIVOTING WORK LIGHT	90
L4 SL	USB RECHARGEABLE STICK LIGHT 550 LUMENS	90
L4™LED	USB RECHARGEABLE 1100L TWIST FOCUS FLASHLIGHT	90
LDM 100	100 M LASER DISTANCE METER	64
LDM 30	30 M LASER DISTANCE METER	64
LDM 45	45 M LASER DISTANCE METER	64
LDM 50	50 M LASER DISTANCE METER	64
LLD50	LASER LINE DETECTOR	63
LM360	360° LASER MOUNT	63
LMP	3.6 M TELESCOPING LASER POLE	63
LRD100	LINE/ ROTARY LASER DETECTOR	62
LWM	LASER WALL MOUNT	63
M12 360IC12	M12™ 360° INSPECTION CAMERA 1.2 M 2ND GEN	78
M12 360IC32	M12™ 360° INSPECTION CAMERA 3 M 2ND GEN	78
M12 3PL	M12™ GREEN 360° 3 PLANE LASER	61
M12 AF	M12™ AIR FAN	57
M12 AL	M12™ LED AREA LIGHT	88
M12 APB	M12™ AUTOMOTIVE PREMIUM BORESCOPE	53
M12 ATB	M12™ AUTOMOTIVE TECHNICIAN BORESCOPE	52
M12 AUN	M12™ AIR-TIP™ UTILITY NOZZLE	57
M12 B2	M12™ 2.0 AH BATTERY	92
M12 B3	M12™ 3.0 AH BATTERY	92
M12 B4	M12™ 4.0 AH BATTERY	92
M12 B6	M12™ 6.0 AH BATTERY	92
M12 BBL	M12™ BLOWER	57
M12 BCST	M12™ SUB COMPACT CABLE STAPLER	43, 55
M12 BD	M12™ SUB COMPACT DRIVER	48
M12 BDC6	M12™ SUB COMPACT DRAIN CLEANER WITH SPIRAL DIAMETER 6 MM	75
M12 BDC8	M12™ SUB COMPACT DRAIN CLEANER WITH SPIRAL DIAMETER 8 MM	75
M12 BDDX	M12™ SUB COMPACT DRILL DRIVER WITH REMOVABLE CHUCK	47
M12 BHCS3L	M12™ HANDHELD CHEMICAL SPRAYER 3.7 L	82
M12 BI	M12™ SUB COMPACT INFLATOR	53
M12 BIW12	M12™ SUB COMPACT 1/2" IMPACT WRENCH	24 - 25, 49
M12 BIW38	M12™ SUB COMPACT 3/8" IMPACT WRENCH	24 - 25, 49
M12 BLP	M12™ BRUSHLESS PLANER	56
M12 BLPRS	M12™ BRUSHLESS PRUNING SHEARS	81
M12 BLROT	M12™ BRUSHLESS ROTARY TOOL	53
M12 BPRT	M12™ SUB COMPACT RIVET TOOL	49
M12 BPS	M12™ SUB COMPACT POLISHER / SANDER	54
M12 BRAID	M12™ SUB COMPACT RIGHT ANGLE IMPACT DRIVER	22, 48
M12 BS	M12™ SUB COMPACT BANDSAW	54
M12 BSD	M12™ SUB COMPACT SINGLE SPEED DRIVER	48
M12 BST	M12™ SUB COMPACT STAPLER	43, 56
M12 BSWP	M12™ HYDROPASS™ BRUSHED STICK WATER PUMP	72
M12 C4	M12™ 4 BAY CHARGER	93
M12 CC	M12™ SUB COMPACT CABLE CUTTER	65
M12 CD	M12 FUEL™ SUB COMPACT DRIVER	48
M12 CHZ	M12 FUEL™ SUB COMPACT HACKZALL™	38, 56
M12 CLL4P	M12™ CROSS LINE LASER WITH 4 POINTS	61
M12 CLLP	M12™ GREEN CROSS LINE LASER WITH PLUMB POINTS	62
M12 CML	M12™ COLOUR MATCHING LIGHT	89
M12 FBFL10	M12 FUEL™ BAND FILE 10 MM	55
M12 FBFL13	M12 FUEL™ BAND FILE 13 MM	55
M12 FBS64	M12 FUEL™ SUB COMPACT BAND SAW WITH 64 MM CUTTING CAPACITY	54
M12 FCIW12G3	M12 FUEL™ 1/2" COMPACT IMPACT WRENCH WITH FRICTION RING	24 - 25, 48
M12 FCIW38G3	M12 FUEL™ 3/8" COMPACT IMPACT WRENCH WITH FRICTION RING	24 - 25, 49

M12 FCIW12G3	M12 FUEL™ 1/2" COMPACT IMPACT WRENCH WITH PIN DETENT	24 - 25, 48
M12 FCN18GS	M12 FUEL™ 18 GA STRAIGHT BRAD NAILER	43, 56
M12 FCOT	M12 FUEL™ SUB COMPACT MULTI-MATERIAL CUT-OFF TOOL	54
M12 FCS442	M12 FUEL™ SUB COMPACT CIRCULAR SAW	38, 56
M12 FDD2	M12 FUEL™ SUB COMPACT DRILL DRIVER	47
M12 FDDX	M12 FUEL™ INSTALLATION DRILL/DRIVER WITH INTERCHANGEABLE HEADS	47
M12 FDGA	M12 FUEL™ ANGLED DIE GRINDER	54
M12 FDGS	M12 FUEL™ STRAIGHT DIE GRINDER	54
M12 FDSS	M12 FUEL™ SUB COMPACT SPOT SANDER	55
M12 FHAC16	M12 FUEL™ COMPACT 16 MM SDS-PLUS HAMMER	15, 47
M12 FHIR14	M12 FUEL™ 1/4" HIGH SPEED RATCHET	50, 51
M12 FHIR14LR	M12 FUEL™ 1/4" EXTENDED REACH HIGH SPEED RATCHET	50, 51
M12 FHIR38	M12 FUEL™ 3/8" HIGH SPEED RATCHET	50, 51
M12 FHIR38LR	M12 FUEL™ 3/8" EXTENDED REACH HIGH SPEED RATCHET	50, 51
M12 FHS	M12 FUEL™ HATCHET™ PRUNING SAW 15 CM	81
M12 FHT20	M12 FUEL™ HEDGE TRIMMER 20 CM	80
M12 FID2	M12 FUEL™ SUB COMPACT 1/4" IMPACT DRIVER	22, 48
M12 FIR12	M12 FUEL™ SUB COMPACT 1/2" RATCHET	50, 52
M12 FIR38	M12 FUEL™ SUB COMPACT 3/8" RATCHET	50, 52
M12 FIR38LR	M12 FUEL™ 3/8" EXTENDED REACH RATCHET	50, 51
M12 FW14	M12 FUEL™ SUB COMPACT 1/4" IMPACT WRENCH	24 - 25, 49
M12 FJS	M12 FUEL™ BODYGRIP JIGSAW	38, 56
M12 FMT	M12 FUEL™ MULTI-TOOL	38, 55
M12 FNB16	M12 FUEL™ 1.6 MM NIBBLER	54
M12 FPD2	M12 FUEL™ SUB COMPACT PERCUSSION DRILL	20, 47
M12 FPDX	M12 FUEL™ SUB COMPACT PERCUSSION DRILL WITH REMOVABLE CHUCK	47
M12 FPTR	M12 FUEL™ INSIDER™ PASS-THROUGH RATCHET	50, 51
M12 FPXP	M12 FUEL™ SUB COMPACT UPONOR™ Q&E EXPANSION TOOL	73
M12 FQID	M12 FUEL™ SURGE™ 1/4" HEX HYDRAULIC IMPACT DRIVER	22, 48
M12 FRAWF12	M12 FUEL™ 1/2" RIGHT ANGLE IMPACT WRENCH WITH FRICTION RING	49, 50
M12 FRAWF38	M12 FUEL™ 3/8" RIGHT ANGLE IMPACT WRENCH WITH FRICTION RING	49, 50
M12 FROS2.5	M12 FUEL™ 150 MM RANDOM ORBITAL SANDER WITH 2.5 MM ORBIT	53
M12 FROS5	M12 FUEL™ 150 MM RANDOM ORBITAL SANDER WITH 5.0 MM ORBIT	53
M12 FSDR75	M12 FUEL™ 75 MM RANDOM ORBIT SANDER	55
M12 FTB	M12 FUEL™ LOW SPEED TYRE BUFFER	53
M12 FVCL	M12 FUEL™ WET/ DRY VACUUM	57
M12 GG	M12™ SUB COMPACT GREASE GUN	52
M12 HB2.5	M12™ HIGH OUTPUT™ 2.5 AH BATTERY	92
M12 HB5	M12™ HIGH OUTPUT™ 5.0 AH BATTERY	92
M12 HH4	M12™ HEATED HOODIE	60
M12 HHLBL1	M12™ HEATED LADIES HOODIE - BLACK	60
M12 HJ CAM06	M12™ HEATED CAMOUFLAGE JACKET	58
M12 HJ5	M12™ HEATED JACKET	58
M12 HPJBL2	M12™ HEATED PUFFER JACKET - BLACK	59
M12 HPJLBL2	M12™ HEATED PUFFER JACKET LADIES - BLACK	59
M12 HPVBL2	M12™ HEATED PUFFER VEST	59
M12 HV	M12™ SUB COMPACT STICK VAC	57
M12 HVGREY1	M12™ HEATED VEST - GREY	59
M12 IR	M12™ SUB COMPACT RATCHET	50, 52
M12 LL	M12™ LED LANTERN LIGHT	89
M12 ONEFTR12	M12 FUEL™ ONE-KEY™ 1/2" DIGITAL TORQUE WRENCH	50, 51
M12 ONEFTR38	M12 FUEL™ ONE-KEY™ 3/8" DIGITAL TORQUE WRENCH	50, 51
M12 ONEHPT	M12™ SUB COMPACT FORCE LOGIC™ HYDRAULIC PRESS TOOL WITH ONE-KEY™	70
M12 PAL	M12™ PIVOT AREA LIGHT	88
M12 PCG/310	M12™ SUB COMPACT CAULK GUN WITH 310 ML CARTRIDGE HOLDER	52
M12 PCG/400	M12™ SUB COMPACT CAULK GUN WITH 400 ML TUBE	52
M12 PCG/600	M12™ SUB COMPACT CAULK GUN WITH 600 ML TUBE	52
M12 PCSS	M12™ RAPTOR™ PIPE CUTTER STAINLESS STEEL	71
M12 PCSS54	M12™ RAPTORXL™ PIPE CUTTER STAINLESS STEEL	71
M12 PL	M12™ PLUMBING LOCATOR	78
M12 POAL	M12™ PACKOUT™ AREA LIGHT 1400 LUMENS	87
M12 RCDAB+	M12™ RADIO CHARGER DAB+	57

TOOLS		4 - 103
M12 SAL	M12™ STAND LIGHT	87
M12 SI	M12™ SUB COMPACT SOLDERING IRON	53
M12 SICO20	M12™ SEWER INSPECTION CAMERA 20 M WITH ONE-KEY™	76
M12 SICO26	M12™ SEWER INSPECTION CAMERA 26 M WITH ONE-KEY™	76
M12 SIM	M12™ SEWER INSPECTION MONITOR	77
M12 SL	M12™ LED STICK LIGHT	89
M12 SLED	M12™ LED SPOT LIGHT	89
M12 SPEJSG2	M12™ JOBSITE SPEAKER	57
M12 TC2	M12™ COMPACT CHARGER AND POWER SOURCE 2	93
M12 TLED	M12™ LED TORCH	90
M12 UCL	M12™ UNDERCARRIAGE LIGHT	89
M12 UDEL	M12™ UNIVERSAL DUST EXTRACTOR	47
M12 UHL	M12™ LED UNDERHOOD LIGHT	89
M12-18 AC	M12™-M18™ CAR CHARGER	93
M12-18 C	M12™ - M18™ CHARGER	93
M12-18 FC	M12™ - M18™ FAST CHARGER	93
M1418C6	M14™ - M18™ MULTIBAY CHARGER	93
M18 ABL	M18™ AREA BOOM LIGHT	88
M18 AFG2	M18™ AIR FAN	45
M18 AL	M18™ LED AREA LIGHT	88
M18 ALIS	M18™ SERVICE AREA LIGHT	88
M18 ARFHP	M18™ HIGH PERFORMANCE AIR FAN	45
M18 B2	M18™ 2.0 AH BATTERY	92
M18 B4	M18™ 4.0 AH BATTERY	92
M18 B5	M18™ 5.0 AH BATTERY	92
M18 B5-CR	M18™ RESISTANT 5.0 AH BATTERY	92
M18 BBL	M18™ BATTERY BLOWER	45
M18 BBPFP2	M18™ BACK PACK FLUID PUMP GEN2	82
M18 BBPFP2-CST	M18™ SWITCH TANK™ 15L CHEMICAL SPRAY TANK	82
M18 BBPFP2-WST	M18™ SWITCH TANK™ 15L WATER SUPPLY	82
M18 BH	M18™ COMPACT 2-MODE SDS-PLUS HAMMER	15, 18
M18 BHG	M18™ HEAT GUN	35
M18 BI	M18™ INFLATOR	45
M18 BIW12	M18™ 1/2" IMPACT WRENCH	24 - 25, 28
M18 BIW38	M18™ 3/8" IMPACT WRENCH	24 - 25, 28
M18 BJS	M18™ TOP HANDLE JIGSAW	38, 40
M18 BLCHTO	M18™ BRUSHLESS 1 TON CHAIN HOIST WITH ONE-KEY™	19
M18 BLCS66	M18™ BRUSHLESS 66 MM CIRCULAR SAW FOR WOOD AND PLASTICS	38, 39
M18 BLDD2	M18™ BRUSHLESS DRILL DRIVER	21
M18 BLDDRC	M18™ COMPACT BRUSHLESS DRILL DRIVER	21
M18 BLH	M18™ BRUSHLESS 4-MODE 26 MM SDS-PLUS HAMMER	15, 18
M18 BLHACD26	M18™ BRUSHLESS 26 MM SDS-PLUS D-HANDLE HAMMER	15, 18
M18 BLHIWF12	M18™ BRUSHLESS 1/2" HIGH TORQUE IMPACT WRENCH WITH FRICTION RING	24 - 25, 28
M18 BLHPT	M18™ FORCE LOGIC™ BRUSHLESS PRESSTOOL	69
M18 BLHPTXL	M18™ FORCE LOGIC™ BRUSHLESS XL PRESS TOOL	69
M18 BLHX	M18™ BRUSHLESS 4-MODE 26 MM SDS-PLUS HAMMER WITH FIXTEC™ CHUCK	15, 18
M18 BLIDR	M18™ BRUSHLESS 1/4" HEX IMPACT DRIVER	22, 23
M18 BLIDRC	M18™ COMPACT BRUSHLESS 1/4" HEX IMPACT DRIVER	22, 23
M18 BLLT	M18™ BRUSHLESS GRASS TRIMMER	79
M18 BLPD2	M18™ BRUSHLESS PERCUSSION DRILL	20, 21
M18 BLPDRC	M18™ COMPACT BRUSHLESS PERCUSSION DRILL	20, 21
M18 BLSAG115XPD	M18 BRUSHLESS 115 MM ANGLE GRINDER WITH PADDLE SWITCH	30, 33
M18 BLSAG125X	M18 BRUSHLESS 125 MM ANGLE GRINDER WITH SLIDE SWITCH	30, 33
M18 BLSAG125XPD	M18 BRUSHLESS 125 MM ANGLE GRINDER WITH PADDLE SWITCH	30, 33
M18 BLSWP	M18™ HYDROPASS™ BRUSHLESS STICK WATER PUMP	72
M18 BLTRC	M18™ BRUSHLESS THREADED ROD CUTTER	67
M18 BLTS	M18™ BRUSHLESS TELESCOPIC SHEAR	82
M18 BMS12	M18™ METAL SHEAR	34
M18 BMS20	M18™ METAL SHEAR	35
M18 BMT	M18™ MULTI-TOOL	38, 40
M18 BOS125	M18™ 125 MM RANDOM ORBITAL SANDER	41
M18 BP	M18™ PLANER	40

M18 BQSS	M18™ QUARTER SHEET SANDER	41
M18 BRAID	M18™ RIGHT ANGLE IMPACT DRIVER	22, 23
M18 BRAIW	M18™ 3/8" RIGHT ANGLE IMPACT WRENCH	28
M18 BSBT	M18™ SHEAR BOLT TOOL	67
M18 BSX	M18™ SAWZALL™	38, 39
M18 BTP	M18™ COMPACT TRANSFER PUMP	72
M18 CDEX	M18 FUEL™ SDS-PLUS DUST EXTRACTOR	18
M18 CHM	M18 FUEL™ 5 KG SDS-MAX DRILLING AND BREAKING HAMMER	15, 16
M18 CRAD2	M18 FUEL™ RIGHT ANGLE DRILL	21
M18 CV	M18™ HAND VAC	44
M18 DBSC	M18™ DUAL BAY SUPER CHARGER	93
M18 DFC	M18™ DUAL BAY RAPID CHARGER	93
M18 F2BCU	M18 FUEL™ DUAL BATTERY BRUSH CUTTER	79
M18 F2BL	M18 FUEL™ DUAL BATTERY BLOWER	82
M18 F2BPB	M18 FUEL™ DUAL BATTERY BACKPACK BLOWER	82
M18 F2CHS50	M18 FUEL™ DUAL BATTERY CHAINSAW 50 CM	81
M18 F2LM46	M18 FUEL™ DUAL BATTERY SELF-PROPELLED LAWN MOWER 46 CM	79
M18 F2LM53	M18 FUEL™ DUAL BATTERY SELF-PROPELLED LAWN MOWER 53 CM	79
M18 F2VC23L	M18 FUEL™ 23L L-CLASS VACUUM	44
M18 FAC	M18 FUEL™ AIR COMPRESSOR	41
M18 FAP	M18 FUEL™ POLISHER	33
M18 FB12	M18™ FORGE™ 12.0 AH BATTERY	92
M18 FB6	M18™ FORGE™ 6.0 AH BATTERY	92
M18 FB8	M18™ FORGE™ 8.0 AH BATTERY	92
M18 FBCU	M18 FUEL™ BRUSH CUTTER	79
M18 FBJS	M18 FUEL™ BODY GRIP JIGSAW	38, 40
M18 FBLG3	M18 FUEL™ BLOWER	81
M18 FBPV	M18 FUEL™ BACKPACK VACUUM	44
M18 FBS127	M18 FUEL™ DEEP CUT BAND SAW GEN 2	34
M18 FBS127D0	M18 FUEL™ DUAL-TRIGGER DEEP CUT BAND SAW WITH ONE-KEY™	34
M18 FBS85	M18 FUEL™ COMPACT BAND SAW	34
M18 FBTS75	M18 FUEL™ 75 MM BELT SANDER	41
M18 FCDDEXL	COMPACT DEDICATED DUST EXTRACTION FOR M18 FUEL™ 26 MM SDS-PLUS HAMMERS	17
M18 FCHS	M18 FUEL™ CHAINSAW WITH 40 CM BAR	80
M18 FCHS35	M18 FUEL™ CHAINSAW WITH 35 CM BAR	80
M18 FCHSC	M18 FUEL™ CHAINSAW WITH 30 CM BAR	81
M18 FCOS230	M18 FUEL™ CUT-OFF SAW	19
M18 FCS552	M18 FUEL™ COMPACT CIRCULAR SAW	37, 38
M18 FCS66GR3	M18 FUEL™ GUIDE RAIL COMPATIBLE CIRCULAR SAW	38, 39
M18 FCSRH662	M18 FUEL™ REAR HANDLE CIRCULAR SAW GEN2	37, 38
M18 FCSSM	M18 FUEL™ COMPACT SECTIONAL SEWER MACHINE	75
M18 FCVN	M18 FUEL™ NEEDLE CONCRETE VIBRATOR	19
M18 FDCPF10	M18 FUEL™ DRAIN CLEANER - POWER FEED 10 MM	74
M18 FDCPF8	M18 FUEL™ DRAIN CLEANER - POWER FEED 8 MM	75
M18 FDD3	M18 FUEL™ DRILL DRIVER	19
M18 FDDEC	M18™ DEDICATED DUST EXTRACTOR FOR M18 FUEL™ HIGH PERFORMANCE 4-MODE 16 MM SDS-PLUS HAMMER	18
M18 FDDEL32	DEDICATED DUST EXTRACTION FOR M18 FUEL™ 32 MM SDS-PLUS D-HANDLE HAMMER WITH AUTOPULSE™	16
M18 FDDEXL	DEDICATED DUST EXTRACTION FOR M18 FUEL™ 26 MM SDS-PLUS HAMMERS WITH AUTOPULSE™	17
M18 FDGRB	M18 FUEL™ BRAKING DIE GRINDER WITH SLIDE SWITCH	34
M18 FDGROVB	M18 FUEL™ BRAKING DIE GRINDER WITH ONE-KEY™, VARIABLE SPEED AND SLIDE SWITCH	34
M18 FDGROVPDB	M18 FUEL™ BRAKING DIE GRINDER WITH ONE-KEY™, VARIABLE SPEED AND PADDLE SWITCH	34
M18 FDN	M18 FUEL™ DUPLEX NAILER	42, 43
M18 FEDG	M18 FUEL™ EDGER	80
M18 FFN	M18 FUEL™ 34° FRAMING NAILER 2-MODE	41, 43
M18 FFN21	M18 FUEL™ 21° FRAMING NAILER 2-MODE	41, 43
M18 FFNS	M18 FUEL™ 34° FRAMING NAILER WITH SINGLE SHOT ONLY	41, 43
M18 FFSDC10	M18 FUEL™ FREE STANDING DRAIN CLEANER 10 MM	74
M18 FFSDC13	M18 FUEL™ FREE STANDING DRAIN CLEANER 13 MM	74
M18 FFSDC16	M18 FUEL™ FREE STANDING DRAIN CLEANER 16 MM	74
M18 FFUS	M18 FUEL™ FENCING UTILITY STAPLER	42, 43
M18 FH	M18 FUEL™ 4-MODE 26 MM SDS-PLUS HAMMER	15, 17

TOOLS		4 - 103
M18 FHAC16	M18 FUEL™ HIGH PERFORMANCE 4-MODE 16 MM SDS-PLUS HAMMER	15, 18
M18 FHACDDE	M18 FUEL™ HIGH PERFORMANCE 4-MODE 16 MM SDS-PLUS HAMMER WITH DEDICATED DUST EXTRACTOR	18
M18 FHACOD32	M18 FUEL™ 32 MM SDS-PLUS D-HANDLE HAMMER WITH ONE-KEY™	15, 16
M18 FFAFOH16	M18 FUEL™ 16 MM SDS-PLUS HAMMER WITH INTEGRATED DUST EXTRACTOR	15, 17
M18 FHET60G2	M18 FUEL™ HEDGE TRIMMER 60 CM	80
M18 FHET75G2	M18 FUEL™ HEDGE TRIMMER 75 CM	80
M18 FHETE22	M18 FUEL™ EXTENDED POLE HEDGE TRIMMER 216 CM	80
M18 FHETE27	M18 FUEL™ EXTENDED POLE HEDGE TRIMMER 267 CM	80
M18 FHIW2F12	M18 FUEL™ 1/2" HIGH TORQUE IMPACT WRENCH WITH FRICTION RING	24 - 25, 27
M18 FHIW2P12	M18 FUEL™ 1/2" HIGH TORQUE IMPACT WRENCH WITH PIN DETENT	24 - 25, 27
M18 FHIWF1R	M18 FUEL™ 1" RAILWAY IMPACT WRENCH WITH FRICTION RING	24 - 25, 26
M18 FHM	M18 FUEL™ ONE-KEY™ 8 KG SDS-MAX DRILLING AND BREAKING HAMMER	15, 16
M18 FHS20	M18 FUEL™ HATCHET™ PRUNING SAW 20 CM	81
M18 FHSAG125XB2	M18 FUEL™ HIGH PERFORMANCE 125 MM BRAKING GRINDER WITH SLIDE SWITCH	30, 31
M18 FHSAG125XPDB2	M18 FUEL™ HIGH PERFORMANCE 125 MM BRAKING GRINDER WITH PADDLE SWITCH	30, 31
M18 FHSAG150XB2	M18 FUEL™ HIGH PERFORMANCE 150 MM BRAKING GRINDER WITH SLIDE SWITCH	30, 31
M18 FHSAG150XPDB2	M18 FUEL™ HIGH PERFORMANCE 150 MM BRAKING GRINDER WITH PADDLE SWITCH	30, 31
M18 FHSAG125VXPDB2	M18 FUEL™ HIGH PERFORMANCE 125 MM BRAKING GRINDER WITH VARIABLE SPEED AND ONE-KEY™	30, 31
M18 FHSAG180VXPDB2	M18 FUEL™ HIGH PERFORMANCE 180 MM BRAKING GRINDER WITH VARIABLE SPEED & ONE-KEY™ GEN 2	30, 31
M18 FHX	M18 FUEL™ 4-MODE 26 MM SDS-PLUS HAMMER WITH FIXTEC™	15, 17
M18 FHZ	M18 FUEL™ HACKZALL™	38, 39
M18 FID3	M18 FUEL™ 1/4" HEX IMPACT DRIVER	22, 23
M18 FIW2F12	M18 FUEL™ 1/2" COMPACT IMPACT WRENCH WITH FRICTION RING	24 - 25, 28
M18 FIW2F38	M18 FUEL™ 3/8" COMPACT IMPACT WRENCH WITH FRICTION RING	24 - 25, 28
M18 FIW2P12	M18 FUEL™ 1/2" COMPACT IMPACT WRENCH WITH PIN DETENT	24 - 25, 28
M18 FJS	M18 FUEL™ TOP HANDLE JIGSAW	38, 40
M18 FLAG230XPDB	M18 FUEL™ 230 MM LARGE BRAKING GRINDER WITH PADDLE SWITCH	30, 31
M18 FMCS	M18 FUEL™ 57 MM METAL CIRCULAR SAW	33
M18 FMCS66	M18 FUEL™ 66 MM METAL CIRCULAR SAW	33
M18 FMDP	M18 FUEL™ MAGNETIC DRILLING PRESS WITH PERMANENT MAGNET	34
M18 FMS190	M18 FUEL™ 190 MM MITRE SAW	35, 36
M18 FMS254	M18 FUEL™ 254 MM MITRE SAW	35, 36
M18 FMS305	M18 FUEL™ ONE-KEY™ 305 MM MITRE SAW	35, 36
M18 FMT	M18 FUEL™ MULTI-TOOL	38, 40
M18 FMTIW2F12	M18 FUEL™ 1/2" MID-TORQUE IMPACT WRENCH WITH FRICTION RING	24 - 25, 27
M18 FMTIW2F38	M18 FUEL™ 3/8" MID TORQUE IMPACT WRENCH WITH FRICTION RING	24 - 25, 27
M18 FMTIW2P12	M18 FUEL™ 1/2" MID-TORQUE IMPACT WRENCH WITH PIN DETENT	24 - 25, 27
M18 FN15GA	M18 FUEL™ 15 GA ANGLED NAIL FINISH NAILER 2-MODE	42, 43
M18 FN16GA	M18 FUEL™ 16 GA ANGLED NAIL FINISH NAILER 2-MODE	42, 43
M18 FN16GS	M18™ FUEL™ 16 GA STRAIGHT FINISH NAILER	42, 43
M18 FN18GS	M18 FUEL™ 18 GS FINISH NAILER	42, 43
M18 FNCS18GS	M18 FUEL™ NARROW CROWN STAPLER 2-MODE	43, 44
M18 FOPH-BA	QUIK-LOK™ BLOWER ATTACHMENT	83
M18 FOPH-BBA	QUIK-LOK™ BRISTLE BRUSH ATTACHMENT	83
M18 FOPH-BCA	QUIK-LOK™ BRUSH CUTTER ATTACHMENT	83
M18 FOPH-CA	QUIK-LOK™ CULTIVATOR ATTACHMENT	83
M18 FOPH-CSA	QUIK-LOK™ CHAINSAW ATTACHMENT	83
M18 FOPH-EA	QUIK-LOK™ EDGER ATTACHMENT	83
M18 FOPH-EXA	QUIK-LOK™ EXTENSION ATTACHMENT	83
M18 FOPH-HTA	QUIK-LOK™ HEDGE TRIMMER ATTACHMENT	83
M18 FOPH-LTA	QUIK-LOK™ GRASS TRIMMER ATTACHMENT	83
M18 FOPH-RA	QUIK-LOK™ RECIPROCATOR ATTACHMENT	83
M18 FOPH-RBA	QUIK-LOK™ RUBBER BROOM ATTACHMENT	83

M18 FOPH-SHTA	QUIK-LOK™ SHORT HEDGE TRIMMER ATTACHMENT	83
M18 FOPH2	M18 FUEL™ OUTDOOR POWER HEAD WITH QUIK-LOK™	83
M18 FOPHLTKIT2	M18 FUEL™ OUTDOOR POWER HEAD - GRASS TRIMMER KIT	83
M18 FPD3	M18 FUEL™ PERCUSSION DRILL	19, 20
M18 FPDDEXL	DEDICATED DUST EXTRACTION FOR M18 FUEL™ 32 MM SDS-PLUS HAMMERS WITH AUTOPULSE™	16
M18 FPFT	M18 FUEL™ POWERED FISH TAPE	66
M18 FPM	M18 FUEL™ PADDLE MIXER	19
M18 FPOVCL	M18 FUEL™ PACKOUT™ WET/ DRY VACUUM	44
M18 FPS55	M18 FUEL™ 55 MM PLUNGE SAW	37, 38
M18 FPT114	M18 FUEL™ PIPE THREADER 1 1/4" WITH ONE-KEY™	70
M18 FPT2	M18 FUEL™ PIPE THREADER 2" WITH ONE-KEY™	70
M18 FPXP	M18 FUEL™ UPONOR™ Q&E EXPANSION TOOL	73
M18 FQID	M18 FUEL™ SURGETM™ 1/4" HEX HYDRAULIC IMPACT DRIVER	22, 23
M18 FR12	M18 FUEL™ 12 MM ROUTER	40
M18 FRAD2	M18 FUEL™ SUPER HAWG® 2-SPEED RIGHT ANGLE DRILL DRIVER GEN II	21
M18 FRCN45	M18 FUEL™ ROOFING COIL NAILER	42, 43
M18 FROP15	M18 FUEL™ RANDOM ORBITAL POLISHER WITH 15 MM STROKE	33
M18 FROP21	M18 FUEL™ RANDOM ORBITAL POLISHER WITH 21 MM STROKE	33
M18 FROS125	M18 FUEL™ 125 MM RANDOM ORBIT SANDER	41
M18 FSAG125X	M18 FUEL™ 125 MM ANGLE GRINDER WITH SLIDE SWITCH	30, 32
M18 FSAG125XB	M18 FUEL™ 125 MM BRAKING ANGLE GRINDER WITH SLIDE SWITCH	30, 32
M18 FSAGF125XB	M18 FUEL™ 125 MM FLATHEAD BRAKING ANGLE GRINDER WITH SLIDE SWITCH	30, 32
M18 FSAGF125XPDB	M18 FUEL™ 125 MM FLATHEAD BRAKING ANGLE GRINDER WITH PADDLE SWITCH	30, 32
M18 FSAGSV0125X	M18 FUEL™ 125 MM SAFETY GRINDER WITH VARIABLE SPEED AND ONE-KEY™	30, 31
M18 FSAGV125XB	M18 FUEL™ 125 MM VARIABLE SPEED & BRAKING ANGLE GRINDER WITH SLIDE SWITCH	30, 32
M18 FSAGV125XPDB	M18 FUEL™ 125 MM VARIABLE SPEED & BRAKING ANGLE GRINDER WITH PADDLE SWITCH	30, 32
M18 FSG	M18 FUEL™ SCREW GUN	23
M18 FSGC	M18 FUEL™ SCREW GUN WITH A COLLATED ATTACHMENT	23
M18 FSX	M18 FUEL™ SUPER SAWZALL™	38, 39
M18 FSZ	M18 FUEL™ SAWZALL™	38, 39
M18 FTHCHS30	M18 FUEL™ TOP HANDLE CHAINSAW WITH 30 CM BAR	81
M18 FTHCHS35	M18 FUEL™ TOP HANDLE CHAINSAW WITH 35 CM BAR	81
M18 FTSP30	M18 FUEL™ TELESCOPIC POLE SAW 30 CM	82
M18 FTR8	M18 FUEL™ TRIM ROUTER WITH 8 MM/ 6 MM COLLETS AND BASES	40
M18 FTS210	M18 FUEL™ ONE-KEY™ TABLE SAW	37, 38
M18 FVP5	M18 FUEL™ VACUUM PUMP 5 CFM	73
M18 GG	M18™ GREASE GUN	29
M18 HB3	M18™ HIGH OUTPUT™ 3.0 AH BATTERY	92
M18 HB5.5	M18™ HIGH OUTPUT™ 5.5 AH BATTERY	92
M18 HCC125	M18™ FORCE LOGIC™ HYDRAULIC 125 MM CABLE CUTTER	65
M18 HCC45	M18™ FORCE LOGIC™ HYDRAULIC 44 MM CABLE CUTTER	65
M18 HCC75	M18™ FORCE LOGIC™ HYDRAULIC UNDERGROUND CABLE CUTTER	65
M18 HCC75R	M18™ FORCE LOGIC™ HYDRAULIC REMOTE UNDERGROUND CABLE CUTTER	65
M18 HCCT	M18™ FORCE LOGIC™ HYDRAULIC 53 KN CABLE CRIMPER	67
M18 HCCT109/42	M18™ FORCE LOGIC™ HYDRAULIC 109 KN CABLE CRIMPER	67
M18 HDCT	M18™ FORCE LOGIC™ HYDRAULIC DIELESS CRIMPER	67
M18 HKP	M18™ FORCE LOGIC™ HYDRAULIC KNOCKOUT PUNCH	66
M18 HMP700	M18™ HYDRAULIC MINI PUMP 700 BAR	29
M18 HOAL	M18™ HIGH OUTPUT AREA LIGHT	87
M18 HOSALC	M18™ HIGH OUTPUT STAND AREA LIGHT CHARGER	87
M18 HSFC125R	M18™ FORCE LOGIC™ HYDRAULIC 125 MM SAFETY CABLE CUTTER	65
M18 HSFSM	M18™ HIGH SPEED FLEXIBLE SHAFT MACHINE	75
M18 HUP700	M18™ HYDRAULIC UTILITY PUMP	66
M18 IL	M18™ LED INSPECTION LIGHT	89
M18 LL	M18™ LED LANTERN LIGHT	89
M18 MDBSC	M18™ MOBILE DUAL BAY SUPER CHARGER	93
M18 MDTL	M18™ MULTI-DIRECTIONAL TASK LIGHT	88
M18 MPC6	M18™ MOBILE PACKOUT™ SIX BAY RAPID CHARGER	93

TOOLS		4 - 103
M18 ONEBLHPT	M18™ FORCE LOGIC™ BRUSHLESS PRESS TOOL WITH ONE-KEY™	69
M18 ONEBLPXL	M18™ ONE-KEY™ FORCE LOGIC™ UPONOR™ Q&E HYDRAULIC PIPE EXPANDING TOOL	73
M18 ONEDD3	M18 FUEL™ ONE-KEY™ DRILL DRIVER	19
M18 ONEFH	M18 FUEL™ 4-MODE 26 MM SDS-PLUS HAMMER WITH ONE-KEY™	15, 17
M18 ONEFHIWF1	M18 FUEL™ ONE-KEY™ 1" HIGH TORQUE IMPACT WRENCH WITH FRICTION RING	24 - 25, 26
M18 ONEFHIWF12	M18 FUEL™ ONE-KEY™ 1/2" HIGH TORQUE IMPACT WRENCH WITH FRICTION RING	24 - 25, 26
M18 ONEFHIWF12E	M18 FUEL™ ONE-KEY™ 1/2" HIGH TORQUE IMPACT WRENCH WITH FRICTION RING AND EXTENDED ANVIL	24 - 25, 26
M18 ONEFHIWF1D	M18 FUEL™ ONE-KEY™ 1" HIGH TORQUE D-HANDLE IMPACT WRENCH WITH FRICTION RING AND EXTENDED ANVIL	24 - 25, 26
M18 ONEFHIWF1DS	M18 FUEL™ ONE-KEY™ 1" HIGH TORQUE D-HANDLE IMPACT WRENCH WITH FRICTION RING AND SHORT ANVIL	24 - 25, 26
M18 ONEFHIWF34	M18 FUEL™ ONE-KEY™ 3/4" HIGH TORQUE IMPACT WRENCH WITH FRICTION RING	24 - 25, 26
M18 ONEFHIWH716	M18 FUEL™ 7/16" HEX UTILITY HIGH TORQUE IMPACT WRENCH WITH ONE-KEY™	24 - 25, 27
M18 ONEFHIWP12	M18 FUEL™ ONE-KEY™ 1/2" HIGH TORQUE IMPACT WRENCH WITH PIN DETENT	24 - 25, 27
M18 ONEFHP	M18 FUEL™ HIGH PERFORMANCE 4-MODE 32 MM SDS-PLUS HAMMER WITH ONE-KEY™	15, 16
M18 ONEFHPX	M18 FUEL™ HIGH PERFORMANCE 4-MODE 32 MM SDS-PLUS HAMMER WITH ONE-KEY™ AND FIXTEC™ CHUCK	15, 16
M18 ONEFHPXDEL	M18 FUEL™ HIGH PERFORMANCE SDS-PLUS HAMMER WITH DEDICATED DUST EXTRACTOR	16
M18 ONEFHX	M18 FUEL™ 4-MODE 26 MM SDS-PLUS HAMMER WITH FIXTEC™ CHUCK AND ONE-KEY™	15, 17
M18 ONEFHXDEL	M18 FUEL™ 4-MODE 26 MM SDS-PLUS HAMMER WITH FIXTEC™ CHUCK, ONE-KEY™ AND WITH DEDICATED DUST EXTRACTOR	17
M18 ONEFIW2FC12	M18 FUEL™ ONE-KEY™ TORQUE-SENSE™ 1/2" CONTROLLED SOLAR COMPACT IMPACT WRENCH WITH FRICTION RING	24 - 25, 26
M18 ONEFLAG230XPDB	M18 FUEL™ ONE-KEY™ 230 MM BRAKING ANGLE GRINDER WITH PADDLE SWITCH	29, 30
M18 ONEFLT	M18 FUEL™ LOCKBOLT TOOL WITH ONE-KEY™	29
M18 ONEFMTIWF2FC12	M18 FUEL™ ONE-KEY™ TORQUE-SENSE™ 1/2" CONTROLLED SOLAR MID-TORQUE IMPACT WRENCH WITH FRICTION RING	23, 24 - 25,
M18 ONEFPRT	M18 FUEL™ RIVET TOOL WITH ONE-KEY™	29
M18 ONEFSAG125XB	M18 FUEL™ ONE-KEY™ 125 MM BRAKING ANGLE GRINDER WITH SLIDE SWITCH	30, 32
M18 ONEFSAG125XPDB	M18 FUEL™ ONE-KEY™ 125 MM BRAKING ANGLE GRINDER WITH PADDLE SWITCH	30, 32
M18 ONEFSZ	M18 FUEL™ ONE-KEY™ SAWZALL™	38, 39
M18 ONEHCC	M18™ FORCE LOGIC™ HYDRAULIC 35 MM CABLE CUTTER	66
M18 ONEHCCT60	M18™ FORCE LOGIC™ HYDRAULIC 60 KN CABLE CRIMPER	67
M18 ONEID3	M18 FUEL™ ONE-KEY™ 1/4" HEX IMPACT DRIVER	21, 22
M18 ONEIWF12	M18 FUEL™ ONE-KEY™ 1/2" IMPACT WRENCH WITH FRICTION RING	24 - 25, 27
M18 ONEIWP12	M18 FUEL™ ONE-KEY™ 1/2" IMPACT WRENCH WITH PIN DETENT	24 - 25, 28
M18 ONEPD3	M18 FUEL™ ONE-KEY™ PERCUSSION DRILL	19, 20
M18 ONERSAL	M18™ ONE-KEY™ LED REMOTE STAND LIGHT	87
M18 ONESLDP	M18™ ONE-KEY™ LED COMPACT SITE LIGHT CHARGER	86
M18 ONESLSP	M18™ ONE-KEY™ LED COMPACT SITE LIGHT	86
M18 PAL2	M18™ PIVOTING AREA LIGHT	88
M18 PC6	M18™ PACKOUT™ SIX BAY RAPID CHARGER	93
M18 POALC	M18™ PACKOUT™ AREA LIGHT CHARGER	87
M18 PRCDAB+	M18™ PACKOUT™ RADIO CHARGER	45
M18 RADDAB+G2	M18™ JOBSITE RADIO DAB+	45
M18 RC	M18™ JOBSITE RADIO CHARGER WITH BLUETOOTH®	45
M18 RLOH600	M18™ 600 M HORIZONTAL ROTARY LASER WITH ONE-KEY™	61
M18 RLOHV1200	M18™ 1200 M HORIZONTAL VERTICAL AUTO DUAL GRADE ROTARY LASER WITH ONE-KEY™	61
M18 RLOHVG300	M18™ 300 M GREEN HORIZONTAL VERTICAL ROTARY LASER WITH ONE-KEY™	61
M18 SAL2	M18™ LED STAND LIGHT	87
M18 SIC30 HDR	M18™ SEWER INSPECTION CAMERA REEL 30 M, 25 MM HDR CAMERA HEAD	76
M18 SIC36 HDR	M18™ SEWER INSPECTION CAMERA REEL 36 M, 25 MM HDR CAMERA HEAD	76
M18 SIC60 HDR	M18™ SEWER INSPECTION CAMERA REEL 60 M, 60 MM CAMERA HEAD	76
M18 SIC60SC HDR	M18™ SEWER INSPECTION CAMERA REEL 60 M, 25 MM CAMERA HEAD	76
M18 SIM	M18™ SEWER INSPECTION MONITOR	77

M18 SISH	M18™ SEWER INSPECTION SMART HUB	77
M18 SLED	M18™ LED SEARCH LIGHT	88
M18 SPEJSG2	M18™ JOBSITE SPEAKER	45
M18 STS0	M18™ FORCE LOGIC™ STRUT SHEAR	72
M18 TAL	M18™ TRADESMAN AREA LIGHT	87
M18 TLED	M18™ LED TORCH	90
M18 VC2	M18™ WET/ DRY VACUUM	44
MCS 66	DRY CUT METAL CIRCULAR SAW	100
MDE 41	MAGNETIC DRILLING PRESS WITH ELECTRO MAGNET	100
MDP 41	MAGNETIC DRILLING PRESS WITH PERMANENT MAGNET	100
ML-LED	ALKALINE FLASHLIGHT	91
MPS	MILWAUKEE® PIPE STAND	71
MSL 1000	MITRE SAW STAND EXTENDABLE UP TO 2 M	35, 36
MSL 2000	MITRE SAW STAND EXTENDABLE UP TO 2.5 M	35, 36
MSL 3000	MITRE SAW STAND EXTENDABLE UP TO 3 M	35, 36
MSUV 280	MITRE SAW STAND EXTENDABLE UP TO 2.8 M	36, 37
MXF C	MX FUEL™ CHARGER	9
MXF COS350G2	MX FUEL™ 350 MM CUT-OFF SAW	6
MXF COSCG2	MX FUEL™ CUT-OFF SAW CART	6
MXF CP203	MX FUEL™ REDLITHIUM™ 3.0 AH BATTERY	9
MXF CVBC	MX FUEL™ BRIEFCASE CONCRETE VIBRATOR	5
MXF CVBP	MX FUEL™ BACKPACK CONCRETE VIBRATOR	5
MXF CVHF	MX FUEL™ HIGH FREQUENCY CONCRETE VIBRATOR	5
MXF DCD150	MX FUEL™ 150 MM DIAMOND CORE DRILL	6
MXF DCD350	MX FUEL™ 350 MM DIAMOND CORE DRILL	6
MXF DH2528H	MX FUEL™ 25 KG CLASS 28 MM HEX DEMOLITION HAMMER	7
MXF DHT	BREAKER TROLLEY FOR MX FUEL™ DEMOLITION HAMMER	7
MXF DR255TV	PREMIUM DIAMOND DRILLING STAND FOR MX FUEL™ DIAMOND CORE DRILL MXF DCD150	6
MXF FC	MX FUEL™ FAST CHARGER	9
MXF FORGENRG-122	MX FUEL™ FORGE BATTERIES AND CHARGER KIT	9
MXF FORGENRG-802	MX FUEL™ FORGE™ BATTERIES AND CHARGER KIT	9
MXF HD812	MX FUEL™ FORGE™ 12.0 AH BATTERY	9
MXF LSDP	MX FUEL™ LARGE SEWER DRUM MACHINE WITH POWERTREDZ™	7, 74
MXF NRG-406	MX FUEL™ BATTERIES AND CHARGER KIT	9
MXF PBE	MX FUEL™ PORTABLE BATTERY EXTENSION	8
MXF PC50	MX FUEL™ PLATE COMPACTOR	4
MXF PS	MX FUEL™ POWER SUPPLY	8
MXF PSC	MX FUEL™ SCREED	5
MXF PTR2	MX FUEL™ PIPE THREADING MACHINE 2"	7, 70
MXF RAM	MX FUEL™ RAMMER	4
MXF SC	MX FUEL™ SUPER CHARGER	9
MXF SMP2	MX FUEL™ SUBMERSIBLE PUMP	5
MXF TL	MX FUEL™ TOWER LIGHT	7, 86
MXF TLIC	MX FUEL™ COMPACT SITE LIGHT	7, 86
MXF WBT60	MX FUEL™ 600 MM WALK BEHIND EDGING TROWEL	5
MXF WBT90	MX FUEL™ 900 MM WALK BEHIND POWER TROWEL	5
MXF XC406	MX FUEL™ REDLITHIUM™ 6.0 AH BATTERY	9
MXF XC608	MX FUEL™ FORGE™ 8.0 AH BATTERY	9
PCE 3/K	3 KG SDS-PLUS CHIPPING HAMMER	94 - 95
PD-705	705 W PERCUSSION DRILL	96 - 97
PD2E 22 R	850 W 2-SPEED PERCUSSION DRILL	96 - 97
PD2E 24 R	1020 W 2-SPEED PERCUSSION DRILL	96 - 97
PDE 13 RX	630 W SINGLE SPEED PERCUSSION DRILL	96 - 97
PDE 16 RP	630 W SINGLE SPEED PERCUSSION DRILL	96 - 97
PFH 26	26 MM SDS-PLUS 2-MODE FIXING HAMMER	94 - 95
PFH 26 T	26 MM SDS-PLUS 2-MODE FIXING HAMMER	94 - 95
PH 26 T	26 MM SDS-PLUS 3-MODE HAMMER	94 - 95
PH 28	28 MM SDS-PLUS 3-MODE HAMMER	94 - 95
PH 30	30 MM SDS-PLUS 3-MODE HAMMER	94 - 95
PLH 28	28 MM SDS-PLUS 3-MODE L-SHAPED HAMMER	94 - 95
PLH 32	32 MM SDS-PLUS 3-MODE L-SHAPED HAMMER	94 - 95
PODS-1	PACKOUT™ COMPATIBLE DUST SEPERATOR	44
RCO	REMOTE SOCKET CONTROLLER	102
RCS	REMOTE CONTROL SOCKET AND CONTROLLER KIT	102

TOOLS 4 - 103

RD1200	ROTARY LASER DETECTOR 1200 M	62
RD300G	ROTARY LASER DETECTOR 300 M GREEN	62
RD600	ROTARY LASER DETECTOR 600 M	62
ROD500	500 CM GRADE ROD	64
ROS 125 E	5" (125 MM) RANDOM ORBIT SANDER	102
SB 2-35 D	1010 W 2-SPEED PERCUSSION DRILL	96 - 97
SCS 65 Q	190 MM CIRCULAR SAW (65 MM DOC)	101
SPS 140	1/4" SHEET SANDER	102
SR240	240 CM STAFF ROD	64
SSD 1100 X	1100 W SAWZALL™	101
SSPE 1300 RX	1300 W SAWZALL™ WITH ROTATING HANDLE	101
SSPE 1300 SX	1300 W SAWZALL™	101
SSPE 1500 X	1500 W SUPER SAWZALL™	101
TRP120	1.2 METER COMPACT LASER TRIPOD	64
TRP160	1.6 METRE LASER TRIPOD	64
TRP180	1.8 METER LASER TRIPOD	63
TRP300	3.0 METRE LASER TRIPOD	63
TSS 1000	TABLE SAW STAND	37
WCE 30	1500 W 125 MM (30 MM DOC) WALL CHASER	97
WCS 45	1900 W 150 MM (45 MM DOC) WALL CHASER	97
WLB	WIRELESS LASER ALIGNMENT BASE	63

SYSTEM ATTACHMENTS 104 - 144

CRIMPING DIES	132 - 133
SIDE HANDLES	123
SYSTEM ATTACHMENTS - ANGLE GRINDERS	128
CUTTING AND GRINDING DUST EXTRACTION	128
FLEXIBLE BACKING PADS	128
SYSTEM ATTACHMENTS - BANDSAWS	129
BANDSAW COVERS	129
SYSTEM ATTACHMENTS - CABLE CUTTERS	134
SYSTEM ATTACHMENTS - CAULK GUNS	138
SYSTEM ATTACHMENTS - CIRCULAR SAWS	129
GUIDE RAILS AND ATTACHMENTS	129
SYSTEM ATTACHMENTS - DIE GRINDERS	121
SYSTEM ATTACHMENTS - DRAIN CLEANERS	110
SYSTEM ATTACHMENTS - DUST ABSORPTION	141 - 143
FILTER BAGS	142
FILTER CARTRIDGES	142
M12™ / M18™ DUST ABSORPTION SYSTEM	141
SYSTEM ATTACHMENTS - AIR TIP™ ATTACHMENTS	143
VACUUM CLEANERS	142
SYSTEM ATTACHMENTS - ELECTRICAL TEST & MEASURING	139
SYSTEM ATTACHMENTS - EXPANSION TOOLS	137
EXPANDER HEADS	137
RAPID SEAL™ EXPANDER HEADS	137
SYSTEM ATTACHMENTS - FLEXIBLE SHAFT MACHINE	144
SYSTEM ATTACHMENTS - HEATED JACKETS	139
SYSTEM ATTACHMENTS - HYDRAULIC PUMP	136
SYSTEM ATTACHMENTS - HYDRAULIC KNOCKOUT PUNCH	136
SYSTEM ATTACHMENTS - IMPACT WRENCHES	124
RUBBER SLEEVES FOR IMPACT WRENCHES	124
SYSTEM ATTACHMENTS - INSPECTION CAMERAS	140
SYSTEM ATTACHMENTS - JIGSAWS	120
SYSTEM ATTACHMENTS - M18 FUEL™ FISH TAPES	135
SYSTEM ATTACHMENTS - MAGNETIC DRILL STANDS	108
SYSTEM ATTACHMENT - NAILERS	120
SYSTEM ATTACHMENTS - NIBBLERS	121
SYSTEM ATTACHMENTS - ONE-KEY™ BLUETOOTH® TRACKING	139
SYSTEM ATTACHMENTS - OUTDOOR PRODUCTS	130 - 131
SYSTEM ATTACHMENTS - BLOWERS	131
SYSTEM ATTACHMENTS - CHAINSAWS	130
SYSTEM ATTACHMENTS - LINE TRIMMERS	131
SYSTEM ATTACHMENTS - MOWERS	131

SYSTEM ATTACHMENTS - OTHER OUTDOOR PRODUCTS	131
SYSTEM ATTACHMENTS - PASS-THROUGH RATCHET	141
SYSTEM ATTACHMENTS - PIPE CUTTERS	134
SYSTEM ATTACHMENTS - PIPE STAND	140
SYSTEM ATTACHMENTS - PIPE THREADER	106 - 107
SYSTEM ATTACHMENTS - PIPE THREADER DIE HEADS	107
SYSTEM ATTACHMENTS - PIPE THREADER DIES	106
SYSTEM ATTACHMENTS - PLANERS	130
PLANER BLADES	130
SYSTEM ATTACHMENTS - PLATE SHEARS	121
SYSTEM ATTACHMENTS - POLISHERS	116 - 118
PREMIUM POLISHING ACCESSORIES - CLOTHS	116
PREMIUM POLISHING ACCESSORIES - COMPOUNDS	116
PREMIUM POLISHING ACCESSORIES - HOOK & LOOP Ø 125 MM	117
PREMIUM POLISHING ACCESSORIES - SPONGES	116
POLISHING ACCESSORIES - HOOK & LOOP Ø 150 MM	117
POLISHING ACCESSORIES - SPOT POLISHER	118
SYSTEM ATTACHMENTS - PORTABLE BATTERY EXTENSION	144
SYSTEM ATTACHMENTS - PRESS JAWS	112 - 115
EMPTY PACKOUT™ FOAM INSERT	115
PIVOTING RING JAWS	115
PRESS JAW ACR STREAMLINE	115
PROFILE BPM	114
PROFILE FF	113
PROFILE G	113
PROFILE G 2	114
PROFILE M	112
PROFILE M 2	114
PROFILE TH	113
PROFILE U	112
PROFILE V	112
PROFILE VIEGA MEGA PRESS	113
SYSTEM ATTACHMENTS - ROTARY HAMMERS	125 - 127
CHUCK KEYS	126
INDUSTRIAL KEYLESS CHUCKS FOR CORDED PERCUSSION DRILLS	127
KEYED CHUCKS	126
KEYED CHUCKS - MACHINE SPECIFIC	126
KEYED CHUCKS WITH 1/4" HEX RECEPTION	126
KEYLESS CHUCKS 2 SLEEVES	127
KEYLESS CHUCKS FOR FIXTEC (SPINDLE LOCK) MACHINES	127
KEYLESS CHUCKS - SPECIFIC TOOL RELATED CHUCKS	127
ROTARY HAMMERS CHUCK ADAPTORS	125
SYSTEM ATTACHMENTS - ROUTERS	140
SYSTEM ATTACHMENTS - SANDERS	118 - 119
BELT SANDERS	118
RANDOM ORBITAL SANDERS	119
SYSTEM ATTACHMENT - SAWZALL™	120
SYSTEM ATTACHMENTS - SCREWDRIVERS	123
SYSTEM ATTACHMENTS - SECTIONAL SEWER MACHINES	111
SYSTEM ATTACHMENTS - STRUT SHEAR	135
SYSTEM ATTACHMENTS - THREADED ROD CUTTER	135
SYSTEM ATTACHMENTS - VIBRATORS	104 - 105
SYSTEM ATTACHMENTS - CONCRETE VIBRATOR HEADS	104
SYSTEM ATTACHMENTS - CONCRETE VIBRATOR WHIPS	104
SYSTEM ATTACHMENTS - HIGH SPEED CONCRETE VIBRATOR	104
SYSTEM ATTACHMENTS - PLATE COMPACTOR	105
SYSTEM ATTACHMENTS - SCREED	105
SYSTEM ATTACHMENTS - TROWEL	105
SYSTEM ATTACHMENTS - WALL CHASERS	122
SYSTEM ATTACHMENTS - WET DIAMOND DRILLING	109
UNIVERSAL RIGHT ANGLE DRILL ATTACHMENT	124
QUIK-LOK™ CABLES	124



Nothing but **HEAVY DUTY.**[™]