



HELUKABEL®

Edition 7

CABLES & ACCESSORIES FOR WIND TURBINES



Edition 7

CABLES & ACCESSORIES FOR WIND TURBINES

HELUWIND WK-SERIE

Data sheets are as of date of print.
 You can find the latest versions online according to this principle:
[www.helukabel.com/10001 en*](http://www.helukabel.com/10001_en)

* Instead of 10001 please insert the wanted part number.

■ EDITORIAL

Cables and wires in wind turbines are as diverse as the wide range of environmental requirements that must be considered when designing them. For example, lightweight and flexible aluminium cables that can be fed into the tower in one length without costly interfaces as well as multi-wire aluminium conductors that can be pre-installed in the individual tower sections; torsion-resistant cables from 0.5 to 400 mm² (20 AWG to 750 kcmil) with different insulation materials and voltage levels that have passed rigorous testing in our torsion test tower; heat-resistant cables for generator connections and slip ring transmitter applications; Ethernet cables and bus technology for data communication; various fibre-optic cables with plug-and-play capabilities for fast installation on site.

In addition to selecting the right construction materials, experience is a crucial factor. We have been supporting customers in the wind power industry for over 20 years. As a leading developer in partnership with the largest turbine and component manufacturers, we are well aware of the different application scenarios and requirements. This expertise is reflected in our cable products and the associated connection technology. With our newly published catalogue, we invite you to discover our recent cable technology developments and solutions for the wind power sector.

Kind regards,



Helmut Luksch,
Chief Executive Officer, HELUKABEL® GmbH



■ HELUKABEL® AT A GLANCE

FAMILY FOCUSED

- Family enterprise since 1978

GLOBAL

- 43 locations in 26 countries
- Just-in time delivery in over 160 countries

SUCCESSFUL

- 476 million Euro turnover
- 1.200 employees

LOGISTICS

- 33,000 products in stock
- 24 h delivery service
- State-of-the-art logistics facility

PRODUCTION

- 6 manufacturing and assembly locations worldwide

QUALITY-MINDED AND ECO-FRIENDLY

- ISO 9001 & 14001 & 50001
- Energy supplied by the firm's own solar and bio-gas plant

PRODUCTS

- Cables, wires and cable accessories
- single-source supplier for industry and infrastructure

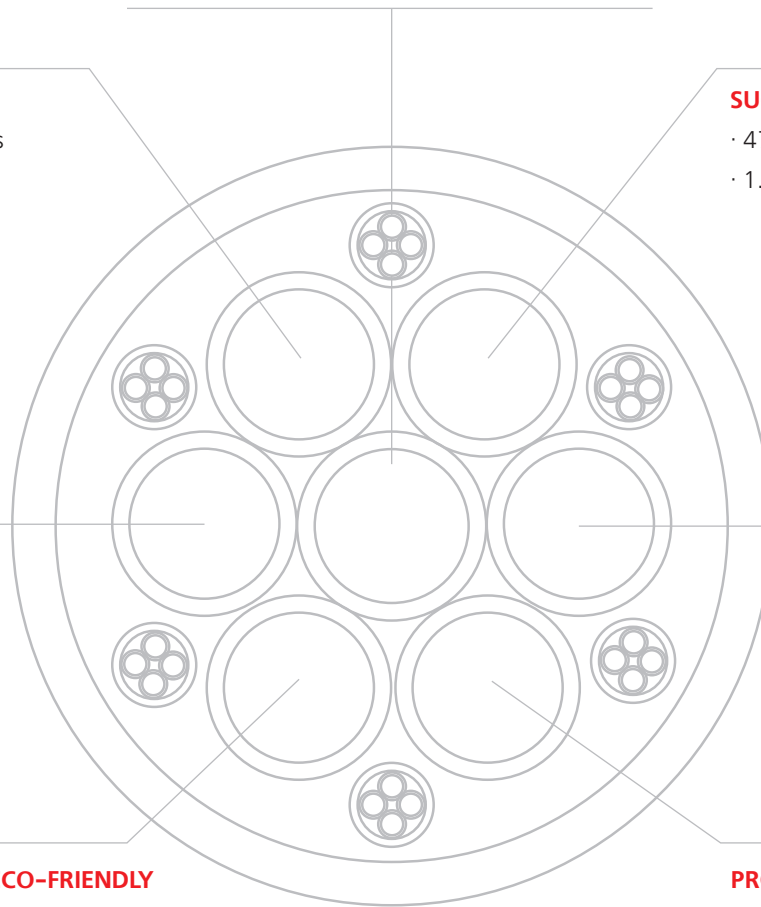

■ TABLE OF CONTENTS

INTRODUCTION	1
Chapter overview	5
Wind turbines: functional overview	6
Selection table: cables & wires	8
Research & development.....	12
Production.....	14
Logistics.....	16
Our values	18
Our branded products.....	20
Always close to you - 43 locations in 26 countries	22
Robotec Systems	24
Kabelmat Wickeltechnik.....	26
TORSION RESISTANT CABLES	28
COPPER POWER CABLES	58
ALUMINIUM POWER CABLES	66
INFRASTRUCTURE CABLES	82
CONTROL CABLES	108
SINGLE CONDUCTORS	154
DATA CABLES	168
CONTROL CABLES UL LISTED	188
COMMUNICATION CABLES FOR WIND TURBINES	218
CABLE ACCESSORIES AND TOOLS	252
TECHNICAL INFORMATION	302
Glossary of cables and wires	337
Part number index	341



■ CHAPTER OVERVIEW



Torsion-resistant cables

0,6/1kV S. 28
1,8/3kV S. 51
3/36kV S. 53

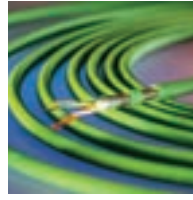

Data cables

S. 168



Copper power cables

0,6/1kV S. 58



Control cables UL listed

S. 188



Aluminium power cables

0,6/1kV S. 66
1,8/3kV S. 77



Communication cables for Wind Turbines

S. 218



Infrastructure cables

S. 82



Tools & Cable Accessories

S. 252



Control cables

S. 108



Technical information

S. 302



Single conductors

S. 154

■ WIND TURBINES: FUNCTIONAL OVERVIEW



NACELLE

Oil-resistant cables for high temperatures

- highly flexible control and bus cables for heavy mechanical loads in rough environments of rotating components
- hybrid cable solutions with increased current carrying capacity for the supply and control of the pitch drive (rotor blade adjustment), from the slip ring through the hollow gearbox shaft to the hub
- torsion-resistant, fire detection cable
- copper and fibre optic data and communication cable



TOWER BASE

Multi-wire and finely stranded power cables

- aluminium and copper cables
- 0.6 / 1 kV to 35 kV for direct burial
- Fibre optic cable for communication and monitoring
- conduit systems

Connection to the grid

Medium-voltage cables

- aluminium and copper cables
- all voltage levels, cross sections up to 1000 mm²
- length and laterally watertight
- Outdoor fibre optic cable for park communication Connection & indoor termination sleeves



■ WIND TURBINES: FUNCTIONAL OVERVIEW

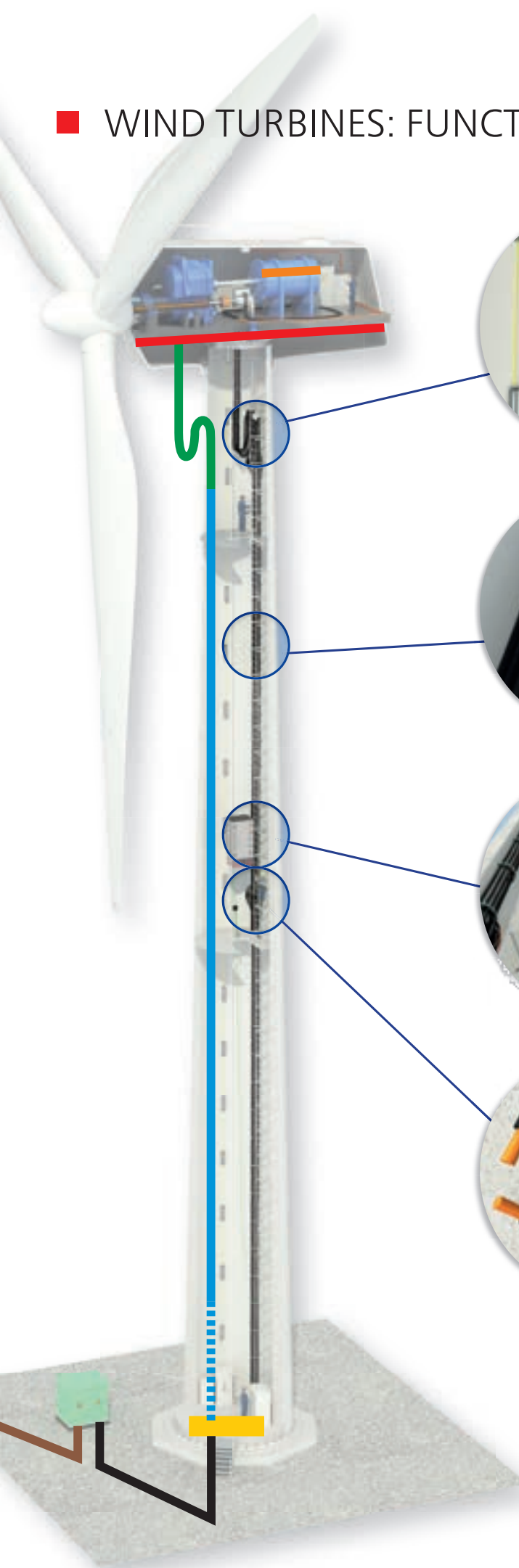

LOOP

Torsion-resistant cables of the HELUKABEL WK series

- tested for more than 15,000 torsion cycles
- for climate zones from -40°C to +145°C
- oil, ozone and UV-resistant
- multiple approvals available
- cable grips

TOWER

Aluminium & copper cables

- multi-wire and finely stranded versions, as well as specific alloys
- 0.6/1 kV – 35 kV
- VDE, CE, UL/CSA listed fastening systems from leading manufacturers

LIFT

HELUKABEL WK Lift Cables

- supply cables for lifts
- as carriage version for mid-level feed-in, optional as flat cables
- high bending and abrasion resistance
- CE & UL/CSA approvals

CONNECTOR

Extensive connectivity solutions

- CU/CU – AL/AL – AL/CU
- available as crimp and screw fitting version
- crimp tools: electro-hydraulic, hand-held press tools

KEY

Cables and wires for usage in:

- Nacelle
- Generator
- Cable loop
- Tower
- ▤ Tower base
- Tower control
- Infrastructure
- Basement

SELECTION TABLE: CABLES & WIRES

Usage, see chart
 Approbation
 fi e tests FT4
 fi e tests FT1 (with FT 2)
 nominal voltage according to UL
 nominal voltage U₀/U_i
 operating peak voltage
 halogen-free
 oil resistant I**
 largely oil resistant
 UV-resistant
 offshore employment
 temp. non-flexing (in °C)
 temp. flexing (in °C)
 twistable +/- per meter
Page

Torsion-resistant cables 0,6/1kV												
WK 103w-Torsion	UL, CSA, CE		x	1000 V	0,6/1kV	x*	x	x	-40 bis +90	-35 bis +90	140°	30
WK 103w EMV D-Torsion	UL, CSA, CE		x	1000 V	0,6/1kV	x*	x	x	-40 bis +90	-35 bis +90	140°	32
WK 103k-Torsion	UL, CSA, CE		x	1000 V	0,6/1kV		x	x	-40 bis +80	-40 bis +80	140°	34
WK 103k EMV D-Torsion	UL, CSA, CE		x	1000 V	0,6/1kV		x	x	-40 bis +80	-40 bis +80	140°	36
WK 135-Torsion	UL, CSA, CE	60332-3		1000 V	0,6/1kV	x	x	x	-40 bis +90	-40 bis +90	150°	38
WK 135 EMV D-Torsion	UL, CSA, CE	60332-3		1000 V	0,6/1kV	x	x	x	-40 bis +90	-40 bis +90	150°	40
WK 137-Torsion FT4	UL, CSA, CE	x ¹ , FT4		1000 V	0,6/1kV	x	x	x	-40 bis +90	-40 bis +90	150°	42
WK 137 EMV D-Torsion FT4	UL, CSA, CE	x ¹ , FT4		1000 V	0,6/1kV	x	x	x	-40 bis +90	-40 bis +90	150°	44
WK 101 H	CE				0,6/1kV	x	x	x	-50 bis +100	-40 bis +90		46
WK 110-Torsion	CE				0,6/1kV	x	x	x	-40 bis +90	-40 bis +90	150°	47
WK H07BN4-F WIND-T	CE				450/750V			x	-45 bis +90	-35 bis +90	150°	48
WK Fire alarm cable-T	CE		x		300/500V	x	x	x	-50 bis +90	-40 bis +80	216°	49
WK DLO, WK DLO-Torsion	UL, CSA	x	x	2000 V				x	-40 bis +90	-40 bis +90	-/150°	50
Torsion-resistant cables 1,8/3kV												
WK 300w-Torsion	CE				1,8/3 kV		x	x	-40 bis +90	-35 bis +90	100°	51
WK 310-Torsion	CE				1,8/3 kV	x	x	x	-40 bis +90	-40 bis +90	150°	52
Torsion-resistant cables 3/36kV												
WK MS 610 Torsion 3,6/6kV					3,6/6 kV		x	x	-40 bis +90	-40 bis +90	105°	53
WK MS-Single-Torsion 12/20 kV					12/20 kV		x	x	-40 bis +90	-40 bis +90	105°	54
WK MS-Single-Torsion UL/CSA	UL, CSA				3,6-20 kV		x	x	-40 bis +90	-40 bis +90	105°	55
WK MS-Multi-Torsion					3,6-38 kV		x	x	-40 bis +90	-40 bis +90	105°	56
WK MS-Multi-Torsion UL/CSA	UL, CSA				3,6-38 kV		x	x	-40 bis +90	-40 bis +90	105°	57

x¹ for Multicore Types

*in preparation

**in accordance with UL 1277, Table 11.2

¹For underground laying or foundation with protection tube only (waterproof)

SELECTION TABLE: CABLES & WIRES

Usage, see chart
 Approbation
 FT1/ IEC 60332-1
 nominal voltage according to UL
 nominal voltage U₀/U_i / operating peak voltage
 halogen-free
 largely oil resistant
 UV-resistant
 temp. non-flexing (in °C)
 temp. flexing (in °C)
 Cu-Shield
 Page

Copper power cables 0,6/1kV											
Wk Thermflex 14		CE			0,6/1kV	x	x	x	-55 bis +145	-20 bis +120	60
N2XH		VDE	60332-3		0,6/1kV	x			-30 bis +90	-5 bis +50	61
Single 600-J/-O		UL, CSA	x	600 V	0,6/1kV			x	-40 bis +90	-5 bis +90	63
Single 600-CY -J/-O		UL, CSA	x	600 V	0,6/1kV			x	-40 bis +90	-5 bis +90	64
Aluminium power cables 0,6/1kV											
NAYY		VDE	x		0,6/1kV				-40 bis +70	-5 bis +50	68
NAY2Y		VDE	x		0,6/1kV				-40 bis +70	-5 bis +50	70
NA2XY		VDE	x		0,6/1kV				-40 bis +70	-5 bis +50	71
Wk (N)A2XH		CE	60332-3		0,6/1kV	x		x	-40 bis +90		72
Wk ALU Tower		CE			0,6/1kV		x	x	-40 bis +90		73
Wk ALU Blade		CE			0,6/1kV		x	x	-40 bis +80		74
Wk POWERLINE ALU ¹		CE	x		0,6/1kV		x	x	-40 bis +105 ³	-20 bis +90	75
Wk POWERLINE ALU robust ¹		CE	x		0,6/1kV		x	x	-40 bis +105 ³	-20 bis +90	76
Aluminium power cables 1,8/3kV											
Wk POWERLINE ALU ¹			x		1,8/3kV		x	x	-40 bis +105 ³	-20 bis +90	77
Wk POWERLINE ALU robust ¹			x		1,8/3kV		x	x	-40 bis +105 ³	-20 bis +90	78
Wk POWERLINE ALU halogenfree ¹			x		1,8/3kV	x	x	x	-40 bis +105 ³	-20 bis +90	79
Wk RHH/RHW-2 ALU ¹				60332-3	1,8/3kV		x	x		-40 bis +90	80
Infrastructure cables											
N2XS _Y - N2XS _{2Y}		VDE			6-30 kV						x 84/86
NA2XS _Y - NA2XS _{2Y}		VDE			6-30 kV						x 92/94
N2XS(F)2Y - N2XS(FL)2Y		VDE			6-30 kV						x 88/90
NA2XS(F)2Y - NA2XS(FL)2Y		VDE			6-30 kV						x 96/98
Wk POWERLINE ALU MS Single					6-30kV		x	x		-20 bis +90	x 100
MV-90 / MV-105 ALUMINIUM / COPPER UL listed		UL		5-35 kV			x	x	90/105		-/x 101
Data cables											
PAAR-TRONIC-CY			x		350V			x	-30 bis +80	-5 bis +80	x 170
DATAFLAMM®			x		350V	x			-30 bis +80	-5 bis +80	172
DATAFLAMM®-C			x		350V	x			-40 bis +70	-5 bis +70	x 173
DATAFLAMM®-C-PAAR			x		350V	x			-40 bis +70	-5 bis +70	x 174
Command cable UL (LiYY)		UL, CSA	x	300V			x		-20 bis +80	-10 bis +80	175
Command cable UL (LiYCY)		UL, CSA	x	300V			x		-20 bis +80	-10 bis +80	x 176
Command cable UL (LiYY-TP)		UL, CSA	x	300V			x		-20 bis +80	-10 bis +80	x 178
Command cable UL (LiYCY-TP)		UL, CSA	x	300V			x		-20 bis +80	-10 bis +80	x 180
SUPERTRONIC®-PURö					350V		x	x	-40 bis +70	-5 bis +70	182
SUPERTRONIC®-C-PURö					350V	x	x	x	-40 bis +70	-30 bis +70	x 183
SUPERTRONIC®-330 PURö		UL, CSA, CE	x	300V	300V	x	x	x	-40 bis +80	-30 bis +80	184
SUPERTRONIC®-330-C-PURö		UL, CSA, CE	x	300V	300V	x	x	x	-40 bis +80	-30 bis +80	x 185
SUPER-PAAR-TRONIC-C-PUR®					350V	x	x	x	-40 bis +70	-30 bis +70	x 186
SUPER-PAAR-TRONIC 340-C-PUR		UL, CSA	x	300V	300V	x	x	x	-40 bis +80	-30 bis +80	x 187

x¹ for Multicore Types

*in preparation

**in accordance with UL 1277, Table 11.2

¹For underground laying or foundation with protection tube only (waterproof)
³maximum 3.000 h

SELECTION TABLE: CABLES & WIRES

Usage, see chart
 Approbation
 FT1/ IEC 60332-1
 nominal voltage according to UL
 nominal voltage U₀/U /
 operating peak voltage
 halogen-free
 largely oil resistant
 UV-resistant
 temp. non-flexing (in °C)
 temp. flexing (in °C)
 Cu-Shield
Page

Control cables												
WK Lift		CE			300/500 V	x	x	x	-40 bis +80	-35 bis +80		110
JZ-500			x		300/500 V		x		-40 bis +80	-15 bis +80		111
JZ-500 COLD			x		300/500 V		x		-40 bis +80	-30 bis +80		113
F-CY-JZ			x		300/500 V		x		-40 bis +80	-10 bis +80	x	114
Y-CY-JZ			x		300/500 V		x		-40 bis +80	-15 bis +80	x	116
JZ-500 HMH			60332-3		300/500 V	x	x		-40 bis +70	-15 bis +70		118
JZ-500 HMH-C			60332-3		300/500 V	x	x		-40 bis +70	-15 bis +70	x	120
MEGAFLEX 500		UL, CSA	60332-3	600 V	300/500 V	x	x	x	-40 bis +80	-30 bis +80		122
MEGAFLEX 500-C		UL, CSA	60332-3	600 V	300/500 V	x	x	x	-40 bis +80	-30 bis +80	x	124
JZ-600			x		0,6/1kV		x	x	-40 bis +80	-15 bis +80		126
JZ-600-Y-CY			x		0,6/1kV		x	x	-40 bis +80	-15 bis +80	x	128
JZ-600 HMH			60332-3		0,6/1kV	x	x		-40 bis +70	-15 bis +70		130
JZ-600 HMH-C			60332-3		0,6/1kV	x	x		-40 bis +70	-15 bis +70	x	132
JZ-600 UL/CSA		UL, CSA	x	1kV	0,6/1kV		x	black	-40 bis +80	-5 bis +80		134
JZ-600-Y-CY-UL/CSA		UL, CSA	x	1kV	0,6/1kV		x	black	-40 bis +80	-5 bis +80	x	136
JZ-602		UL, CSA	x	600 V			x		-40 bis +90	-5 bis +90		138
JZ-602-CY		UL, CSA	x	600 V			x		-40 bis +90	-5 bis +90	x	140
JZ-603		UL, CSA, HAR	x	600 V	300/500 V		x		-40 bis +70	-5 bis +70		142
JZ-603-CY		UL, CSA, HAR	x	600 V	300/500 V		x		-40 bis +70	-5 bis +70	x	143
H07RN-F		HAR			450/750 V		x		-30 bis +60	-25 bis +60		145
SOOW		UL, CSA		600 V			x	x	-40 bis +90			147
WK POWERLINE ALU Multi		CE	x		0,6/1kV		x	x	-40 bis +90	-20 bis +90		148
HELUTHERM® 145 MULTI		GL	60332-3		300/500 V	x	x	x	-55 bis +145	-35 bis +120		149
HELUTHERM® 145 MULTI/-C		GL	60332-3		300/500 V	x	x	x	-55 bis +145	-35 bis +120	x	151
Control cables UL listed												
TRAYCONTROL® 300		UL, CSA	FT 4	300V			x		-25 bis +105	-25 bis +105		193
TRAYCONTROL® 300-C		UL, CSA	FT 4	300V			x		-25 bis +105	-25 bis +105	x	195
TRAYCONTROL® 300 TP		UL, CSA	FT 4	300V			x		-25 bis +105	-25 bis +105		197
TRAYCONTROL® 300-C TP		UL, CSA	FT 4	300V			x		-25 bis +105	-25 bis +105	x	199
TRAYCONTROL® 500		UL, CSA	FT 4	600V			x		-40 bis +90	-5 bis +90		201
TRAYCONTROL® 500-C		UL, CSA	FT 4	600V			x		-40 bis +90	-5 bis +90	x	203
JZ-604 TC TRAY CABLE		UL, CSA	FT 4	600V			x	x	-25 bis +90	-5 bis +90		205
JZ-604-YCY TC TRAY CABLE		UL, CSA	FT 4	600V			x	x	-25 bis +90	-5 bis +90	x	207
TRAYCONTROL® 600		UL, CSA	FT 4	600V			x	x	-40 bis +90	-5 bis +90		208
TRAYCONTROL® 600-C		UL, CSA	FT 4	600V			x	x	-40 bis +90	-5 bis +90	x	210
TRAYCONTROL 610 OIL RES II		UL, CSA	FT 4	1000V			x	x	-40 bis +90	-40 bis +90		211
MULTIFLEX 600		UL, CSA	FT 4	600V			x	x	-40 bis +90	-5 bis +90		213
MULTIFLEX 600-C		UL, CSA	FT 4	600V			x	x	-40 bis +90	-5 bis +90	x	214
TOPFLEX® 600 VFD		UL, CSA	FT 4	600V			x	x	-25 bis +90	25 bis +90	x	215
TOPFLEX® 650 VFD		UL, CSA	FT 4	600V			x	x	-25 bis +105	-25 bis +105	x	216

x¹ for Multicore Types

*in preparation

**in accordance with UL 1277, Table 11.2

¹For underground laying or foundation with protection tube only (waterproof)

SELECTION TABLE: CABLES & WIRES

Usage: see chart
 Approbation
 FT1/IEC 60332-1
 nominal voltage U₀/U /
 operating peak voltage
 operating peak voltage
 halogen-free
 largely oil resistant
 UV-resistant
 temp. non-flexing (in °C)
 temp. flexing (in °C)
 Cu-Shield
Page

Single conductors												
WK POWERLINE ALU Single		CE	x		0,6/1kV		x	x	-40 bis +105	-20 bis +90		156
H07 V-K/(H)07 V-K		HAR	x		450/750V				-30 bis +80	-5 bis +70		157
H05Z-K/H07Z-K		HAR	x		300/500V	x			-40 bis +90	-5 bis +70		159
FIVENORM		UL, CSA, HAR	x						-40 bis +90	-5 bis +90		161
HELUTHERM® 145		GL	x		300/500V	x	x	x	-55 bis +145	-35 bis +120		164
HELUTHERM® 145 600V		UL, CSA, GL	x	600V		x	x	x	-55 bis +105	-35 bis +105		166
THHN/THWN		UL, CSA		600V			x		bis +75/90			167
Communication cables for Wind Turbines												
PROFInet Type B SF/UTP PVC flexibl		UL, CSA, CE	FT4	300V	100V		x	x	-40 bis +70	-40 bis +70	x	230
PROFInet Type C Torsion S/UTP PUR		UL, CSA, CE	FT2		100V	x	x	x	-40 bis +80	-40 bis +80	x	231
WK Industrial SF/UTP X-FRNC 105°C		UL, CSA, CE	60332-3	300V	100V	x	x	x	-40 bis +105 ²	-40 bis +105 ²	x	232
TORDIERFLEX Industrial Ethernet SF/UTP PUR		UL, CSA, CE	x	30V	50V	x	x	x	-20 bis +80	-20 bis +80	x	233
WK CAN BUS 105°C		UL, CSA, CE	x	600V	100V	x	x	x	-40 bis +105	-20 bis +90	x	234
PROFIBUS SK indoor		UL, CSA, CE	FT4	600V	100V		x	x	-40 bis +80	-5 bis +60	x	235
PROFIBUS SK outdoor ¹		CE			100V	x		x	-20 bis +70	-5 bis +60	x	235
PROFIBUS L2 Torsion		UL, CSA, CE	x	300V	100V	x	x	x	-25 bis +75	-25 bis +75	x	236
PROFIBUS SK Industrial		UL, CSA, CE	x	30V	100V	x	x	x	-40 bis +70	-5 bis +60	x	237
HELUCOM® AT-V(ZN)Y(ZN)Y		UL, CSA	FT4				x	x	-40 bis +90	-40 bis +90		238
HELUCOM® AT-V(ZN)H(ZN)11Y						x	x	x	-40 bis +90	-40 bis +90		238
HELUCOM® WK mobile A-V(ZN)11Y			x			x	x	x	-30 bis +70	-20 bis +70		239
HELUCOM® WK mobile A-V(ZN)YY		UL, CSA	FT4				x	x	-30 bis +80	-20 bis +80		240
HELUCOM® LWL-Breakout cable Industrial HCS I-V(ZN)YY		UL, CSA	FT4				x	x	-30 bis +85	-20 bis +85		241
HELUCOM® LWL-Breakout cable Industrial HCS I-V(ZN)Y11Y							x		-20 bis +70	-20 bis +70		242
HELUCOM® Plastic-fibre optic cable PROFInet B POF/PA I-V4Y(ZN)Y		UL, CSA	FT4				x		-30 bis +70	-10 bis +50		243
HELUCOM® Plastic-fibre optic cable PROFIBUS POF/PA I-V4Y(ZN)Y		UL	FT1				x	x	-30 bis +70	-10 bis +50		244
HELUCOM® Plastic-fibre optic cable Industrial POF/PE I-V2Y, I-V2Y(ZN)11Y							x	x	-20 bis +80	-20 bis +80		245
HELUCOM® LWL-Universal cable A/I-DQ(ZN)BH			x			x	x	x	-20 bis +60	-5 bis +50		246
HELUCOM® LWL-outdoor cable A-DQ(ZN)B2Y (central)								x	-20 bis +60	-5 bis +50		247
HELUCOM® LWL-outdoor cable A-DQ(ZN)B2Y (stranded)								x	-20 bis +60	-5 bis +50		248
HELUCOM® LWL-outdoor cable A-DQ(ZN)B2Y (stranded, Multifibre)								x	-20 bis +60	-5 bis +50		249
LIYY-TP-UL		UL, CSA		300V			x		-20 bis +80	-10 bis +80		250

x¹ for Multicore Types

*in preparation

**in accordance with UL 1277, Table 11.2

¹For underground laying or foundation with protection tube only (waterproof)

²With limited life cycle



■ RESEARCH & DEVELOPMENT

We develop optimal, tailored cable solutions for our customers.



Drag chain test system

Our test facilities:

- Test systems for bending and torsion requirements
- Drag chain test systems with movement distances of 1 m, 3 m, 5 m, 6 m, 18 m, and 40 m
- Fire testing systems
- Abrasion testing systems
- Torsion test tower for wind turbine cables
- Aging ovens in accordance with UL, VDE, CSA, HAR, TÜV, CCC

Research and development are the foundation of our work and are an important engine for growth. Using interdisciplinary teams, we continuously push the boundaries to enhance our products and develop solutions to meet the latest technological demands. Additionally, our invaluable customer interactions, and partnerships with regional universities and research institutes allows us to stay on top of the latest emerging technologies.

When it comes to the development of new products and the materials we use, we place as much emphasis on searching for and utilising new materials as we do on manufacturing our plastic granulate mixtures ourselves. We do this in order to influence the enhancement of properties such as oil resistance, temperature range and chemical compatibility. Furthermore, we are capable of drawing the majority of our copper ourselves, thereby ensuring a consistently high level of quality with respect to properties and processing. By continuously optimising our manufacturing processes and facilities, we are striving to produce cables and wires more efficiently and economically and to accommodate the complex requirements of a wide variety of applications.

New products are tested in state-of-the-art research and development centres to ensure that they perform as specified and are ready for series production. Random sampling of products in production as well as tight measurement and control procedures guarantee our high level of quality.

The torsion properties of the HELUWIND® WK series cables are extensively tested to requirements that far exceed those of wind turbine manufacturers. The loop in the torsion test tower at our Windsbach plant is an exact replica of a wind turbine. Up to 20 cables can be assembled and tested at the same time in a specially designed cable bracket from Roxtec. A custom-made drive and control mechanism conducts a variety of torsion cycles and programs based on real rotational movements of the nacelle. Cables experience the stress of up to 18,000 cycles and the maximum required torsion of up to +/- 150° per meter. These test conditions are far more extreme than in actual application, but the findings gained from these tests directly influence the future development of our HELUWIND® WK torsion series.



Torsion test tower





■ PRODUCTION

We specialize in the production of high-quality cables and wires.

Using the latest production methods, our two German plants manufacture approximately one million kilometers of conductors each year (25 times around the world). More than 300 qualified employees are specialized in the production of high-quality standard and custom cables. Through the use of the latest materials and collaboration with international test institutes, we drive innovation in the areas of automation, data technology, building system technology, and renewable energy.

Since 2014, HELUKABEL has been producing cables and wires in the Chinese city of Taicang (Shanghai), primarily for the Asian market. As is with our German plants, the focus is on high-quality, flexible and highly-flexible cables and wires that are manufactured in accordance with Chinese and international standards. The use of flexible manufacturing cells enable short delivery times.



Braiding machine

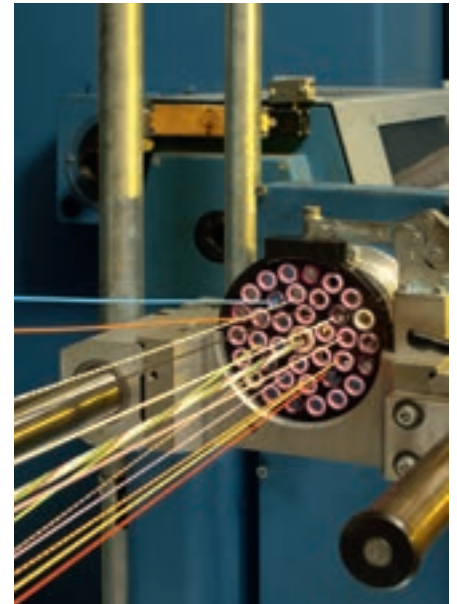

Stranding machine

Our production in numbers:

- Cables & wires from 0.05 to 1,000 mm² (30 AWG to 2,000 kcmil)
 - 40,000 m² production area
 - 23 extruder systems
 - 19 stranding machines
 - 50 braiding machines
- Manufacturing in accordance with: VDE, CE, EAC (GOST-R), UL, CSA, HAR, CCC, Germanischer Lloyd, TÜV or customer specification



■ LOGISTICS

Redefining logistics in the cable industry.

INDUSTRIAL CABLE

Our logistics center – Hemmingen/Stuttgart

- 40,500 Euro-pallet racks with max. reel weight of 1,500 kg; 16 aisles with 16 storage and retrieval devices
- 36,800 bin locations in the automatic small parts warehouse with a capacity of 1,000 bins per hour
- 670 storage spaces in the heavy load warehouse with max. reel weight of 4,000 kg and 2.20 m diameter
- 2 km conveyor line for pallets
- Conveyer connects direct to the cable-cutting machines
- Manual processes reduced to merely packing

INFRASTRUCTURE CABLES

Our logistics center – Neuenhagen/Berlin

- 11,000 cable reels in stock
- Automatic processing of reels up to 2.80 m diameter and 10 t
- 10 rewinding machines
- Cut to length with state-of-the-art 1,200 mm² cutting tools
- 24-hr delivery is possible

At its corporate headquarters in the Swabian town of Hemmingen/ Stuttgart, HELUKABEL® operates Europe's largest distribution center for cables and wires. Here a majority of the more than 33,000 products are located in a storage area of 160,000 m². Through the use of state-of-the-art conveyor and control technology, more than 1,000 orders can be picked and dispatched daily to destinations around the world.

Neuenhagen/Berlin is the central warehouse location for underground, medium-voltage, and other infrastructure cables. Storage capacities of more than 5,000 m² (indoor) and 50,000 m² (outdoor) enable fast delivery of cable, configured from 1 - 30 kV, to construction sites and major projects. The patented heavy-load cable-cutting machines with a load capacity of more than 10 tons are the largest of their kind in Germany.

The new logistics center at the Taicang production facility serves as a product distribution hub for the Asian market, and offers incredible advantages, particularly for servicing time- and volume-critical customer projects.



Heavy-load, cable-cutting facility



Small parts warehouse



■ OUR VALUES

Success through quality and innovation

HELUKABEL® GmbH is an independent company that develops, manufactures and sells cables, wires and accessories. In an environment of increasing expectations from both customers and society, the growth strategy of HELUKABEL® GmbH is based on consistent target orientation, high adaptability and continuous development of its management system. Our goal is to achieve sustainable business success through the confidence and satisfaction of our customers and society. As a result, HELUKABEL® GmbH places great emphasis on

the quality and environmental impact of its processes and products, the efficient use of resources and energy, and on satisfying legal and regulatory requirements. This is why HELUKABEL® GmbH developed and implemented an integrated management system for quality, environmental impact and energy performance based on the DIN EN ISO 9001, DIN EN ISO 14001 and DIN EN ISO 50001 standards. Our high standards are reflected in the following criteria:



The integrated management system for quality, environmental impact and energy performance reinforces HELUKABEL®'s success as a company and documents our work processes, which all employees and managers are bound to implement in accordance with what is prescribed in the management handbook.



■ OUR BRANDED PRODUCTS

Cables & wires

- BIOFLEX-500® bio-oil resistant cables
- CLEANFLEX® cleanroom data and control cables
- DATAFLAMM® data and computer cables, halogen free
- DATAPUR-C® data and computer cables
- GALVANICABLE® high-voltage cathode cable
- HELUFLON® heat-resistant cables
- HELUTHERM® heat-resistant cables
- HELUTRAIN® train cables
- HELUTRUCK® vehicle cables/truck cables
- HELUWIND® wind power cables
- KOMPOFLEX® microbe-resistant cables
- KOMPOSPEED® bio-oil resistant drag chain cables
- LIFT-TRAGO® elevator control cables
- MEGAFLEX® flexible control cables, halogen free, UL/CSA
- MULTIFLEX 512® PUR drag chain cables
- MULTISPEED® drag chain cables
- NANOFLEX® PUR special control and data cables
- ROBOFLEX® robot cables
- SENSORFLEX® sensor cables
- SHIPFLEX® drag chain cables
- SOLARFLEX® photovoltaic cables
- SUPER-PAAR-TRONIC-C-PUR® drag chain cables, halogen free
- SUPERTRONIC® drag chain cables
- THERMFLEX® heat-resistant cables
- TOPFLEX® servo, feedback and motor cables
- TOPSERV® servo, feedback and motor cables
- TRAYCONTROL® exposed run cable
- TROMMPUR® easy-to-wind cables
- UNIPUR® PUR, flexible control cables

Cable accessories

- HELUCHAIN® drag chain product line
- HELUTEK® industrial connector series
- HELUTOP® cable gland product line

Data, network & bus technology

- HELUCOM® fiber optic cables
- HELUKAT® fiber optic connection technology
- HELUKAT® copper data cable
- HELUKAT® copper connection technology

Media technology

- HELUEVENT® high-powered cable for TV studios
- HELULIGHT® cables for lighting control systems
- HELUSOUND® audio cable

■ ALWAYS CLOSE TO YOU – 43 LOCATIONS IN 26 COUNTRIES

HELUKABEL® GmbH – Germany



Headquarters

Dieselstraße 8-12
71282 Hemmingen / Stuttgart
PH +49 7150 9209-0
Fax +49 7150 81786
info@helukabel.de

Sales office & warehouse – Berlin

Zum Mühlenfließ
15366 Neuenhagen / Berlin
PH +49 3342 2397-0
Fax +49 3342 80033
info@helukabel.de

Sales office & warehouse – Pleiße

Eichelbergstraße 7
09212 Limbach-Oberfrohna
PH +49 3722 6086-0
Fax +49 3722 6086-420
info@helukabel.de

Sales office – North

Victoriastraße 2
25524 Itzehoe
PH +49 4821 40394-0
Fax +49 4821 40394-29
info@helukabel.de

Sales office Rhein-Ruhr

Centroallee 261
46047 Oberhausen
PH +49 208 882320-0
Fax +49 208 882320-10
info@helukabel.de

Development & production

Neuseser Weg 11
91575 Windsbach
PH +49 9871 6793-0
Fax +49 9871 1055
info@helukabel.de

Robotec Systems GmbH – Germany

Theodor-Heuss-Straße 99
47167 Duisburg
PH +49 203 935424-0
Fax +49 203 935424-10
www.robotec-systems.de
info@robotec-systems.de

Kabelmat Wickeltechnik GmbH – Germany

Steinbuckelweg 25
72293 Glatten
PH +49 7443 9670-0
Fax +49 7443 9670-39
www.kabelmat.com
kabelmat@kabelmat.com

HELUKABEL® international locations



HELUKABEL® Austria

PH +43 7224 90555 0
Email: office@helukabel.at



HELUKABEL® Netherlands

PH +31 495 499 049
Email: info@helukabel.nl



HELUKABEL® Tchech Republic

PH +42 0312 672 620
Email: prodej@helukabel.cz



HELUKABEL® Belgium

PH +32 24 81 00 20
Email: info@helukabel.be



HELUKABEL® Poland

PH +48 46 85 80 10 0
Email: biuro@helukabel.pl



HELUKABEL® Thailand

PH +66 2927 3570 3
Email: info@helukabel.co.th



HELUKABEL® China

PH +86 21 58693999
Email: info@helukabel.com.cn



HELUKABEL® Portugal

PH +351 239 099596
Email: geral@helukabel.pt



HELUKABEL® Turkey

PH +90 212 502 41 95
Email: info@helukabel.com.tr



HELUKABEL® France

PH +33 389 627562
Email: info@helukabel.fr



HELUKABEL® Russia

PH +7 812 449 10 60
Email: info@helukabel.ru



HELUKABEL® UK

PH +44 151 345 0808
Email: info@helukabel.co.uk



HELUKABEL® India

PH +91 22 25 18 58 41
Email: info@helukabel.in



HELUKABEL® Singapore

PH +65 65 54 6170
Email: sales@helukabel.com.sg



HELUKABEL® USA

PH +1 847 930 5118
Email: sales@helukabel.com



HELUKABEL® Indonesia

PH +62 213 848872
Email: sales@helukabel.co.id



HELUKABEL® South Afrika

PH +27 11 462 8752
Email: info@helukabel.co.za



HELUKABEL® UAE

PH +971 48 87 95 94
Email: info@helukabel.ae



HELUKABEL® Italy

PH +39 039 6081503
Email: info@helukabel.it



HELUKABEL® South Korea

PH +82 51 9728646
Email: info@helukabel.co.kr



HELUKABEL® Vietnam

PH +84 8 38443698
Email: info@helukabel.com.vn



HELUKABEL® Canada

PH +1 289 444 5040
Email: sales@helukabel.ca



HELUKABEL® Sweden

PH +46 8 55 77 4280
Email: info@helukabel.se



HELUKABEL® Malaysia

PH +603 7885 8724
Email: sales@helukabel.com.my



HELUKABEL® Switzerland

PH +41 56 4181515
Email: contact@helukabel.ch

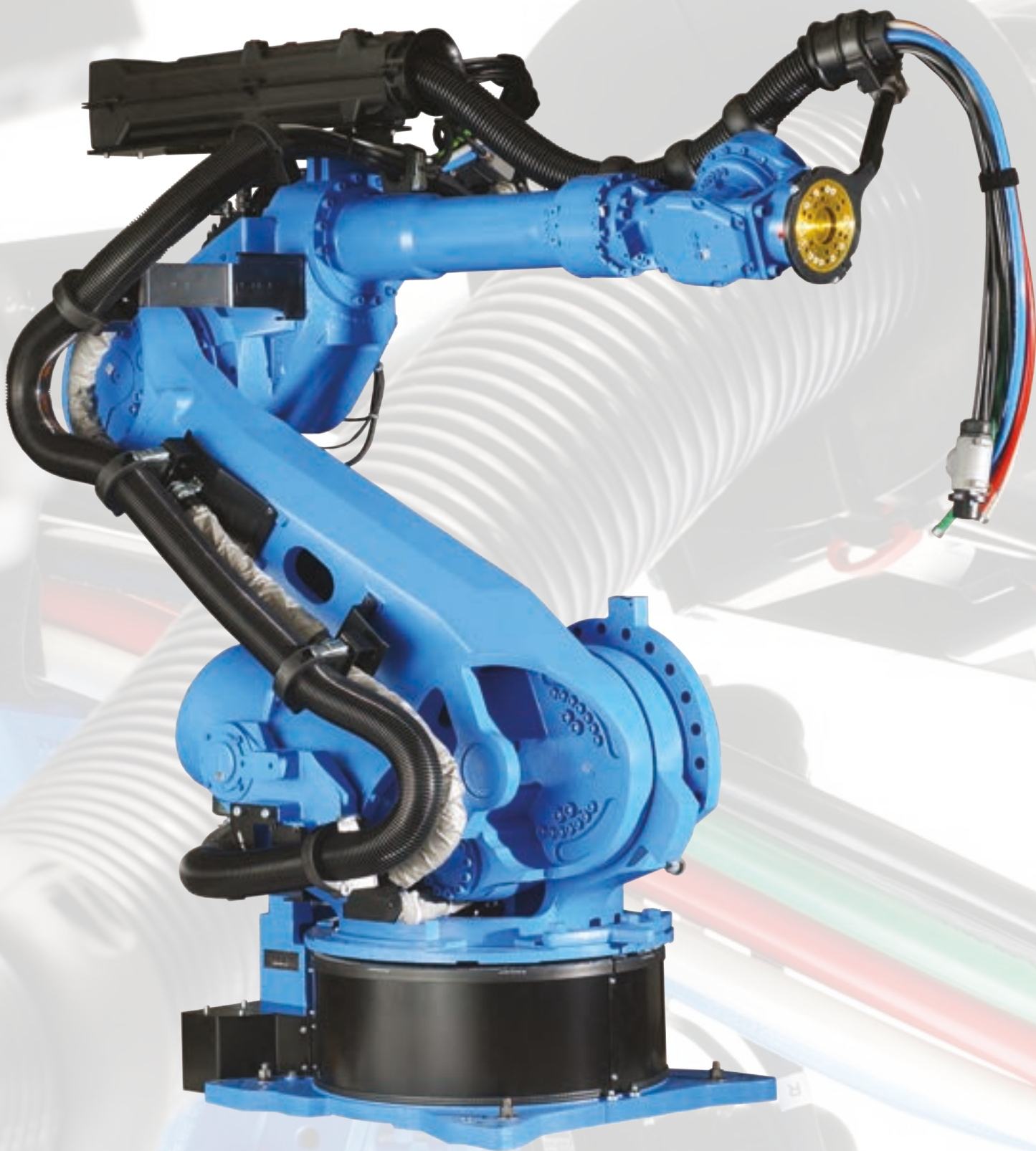

■ ROBOTEC SYSTEMS - UNMATCHED ROBOTIC COMPETENCE

Since its founding in 1998, Robotec Systems GmbH, headquartered in Duisburg, Germany, has become one of the leading European companies for robot hose packages and associated fastening systems as well as for custom robot cables, cable assemblies, power screwdriver technology, controllers for measurement instrumentation and media systems such as air hoses and water hoses. The company has been a 100% subsidiary of HELUKABEL® GmbH since July 2012.

Robotec Systems develops tailored energy-supply systems that are pre-assembled and ready to install. From the development

of various design concepts to prototyping, to final installation and on-site service, Robotec is a single source for all robotic services.

Through the use of first-class components, as well as superstructures and material compositions tailored for the respective application, the highest level of reliability and productivity is achieved.

Robotec's products are used in applications, such as spot, laser and inert gas welding, robot handling, and tool changing systems.

Our components:

- Fastening elements & accessories
- Pivot bearings
- Spring clamps
- Protector/impact protection
- Trumpet & accessories
- Precision pipes
- Self-fastening hoses & accessories
- Cable protection hoses
- Attachment parts
- Primary cables
- Control cables
- BUS system cables
- Pre-assembled special cables

Robotec Systems GmbH

Theodor-Heuss-Str. 99
47167 Duisburg
Telephone: +49 203 935424-0
Fax: +49 203 935424-10
www.robotec-systems.de
info@robotec-systems.de



Concept

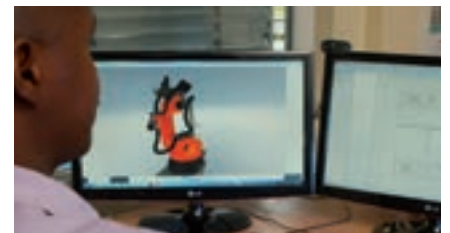

Development



Prototyping



Installation/optimization



Documentation



Repair/maintenance



 **kabelmat**
WICKELTECHNIK

Control panel with various buttons and a digital display.

■ KABELMAT WICKELTECHNIK GMBH

Kabelmat Wickeltechnik GmbH's history goes back to the 1960s and since then the company has been among the market leaders for winding systems in the cable and wire industry.

Customers include manufacturers, retailers, cable and wire processors, as well as cable assemblers, electricians, machine manufacturing companies, and many more.

The product range includes virtually all devices and machines for storing, winding and cutting cables, wires, rope, tubes, hoses, and profiles. Winding from and onto drums, as well as from drums to rings are among the tasks that are efficiently executed worldwide with Kabelmat products. We would be pleased to show you our products in our showroom. You are cordially invited to visit us at our facility.



MESSBOI® 40

We offer:

- Manual winding technology
- Automatic winding technology
- Measuring technology
- Storage technology

Our services:

- Project planning & engineering
- Manufacturing & final assembly
- Service & maintenance

Kabelmat Wickeltechnik GmbH

Steinbuckelweg 25
72293 Glatten
Tel. + 49 7443 9670-0
Fax + 49 7443 9670-39
kabelmat@kabelmat.com



PORTROL® 2600 - 3000

HELUWIND® WK 103-Torsion

HELUWIND® WK 137-Torsion FT4

HELUWIND® WK MS Multi-Torsion

HELUWIND® WK Fire alarm cable-Torsion



■ TORSION-RESISTANT CABLES

Designation	Page
Torsion-resistant cables 0,6kV/1kV	28
HELWIND® WK 103w-Torsion	30
HELWIND® WK 103w EMV D-Torsion	32
HELWIND® WK 103k-Torsion	34
HELWIND® WK 103k EMV D-Torsion	36
HELWIND® WK 135-Torsion	38
HELWIND® WK 135 EMV D-Torsion	40
HELWIND® WK 137-Torsion FT4	42
HELWIND® WK 137 EMV D-Torsion FT4	44
HELWIND® WK 101 H	46
HELWIND® WK 110-Torsion	47
HELWIND® WK H07BN4-F WIND-Torsion	48
HELWIND® WK Fire alarm cable-Torsion	49
HELWIND® WK DLO, WK DLO-Torsion	50
Torsion-resistant cables 1,8/3kV	51
HELWIND® WK 300w-Torsion 1,8/3kV	51
HELWIND® WK 310-Torsion 1,8/3KV	52
Torsion-resistant cables 3/36kV	53
HELWIND® WK MS Single 610-Torsion	53
HELWIND® WK MS-Single-Torsion	54
HELWIND® WK MS-Single-Torsion UL/CSA	55
HELWIND® WK MS-Multi-Torsion	56
HELWIND® WK MS-Multi-Torsion UL/CSA	57

HELUWIND® WK 103w-Torsion

0,6/1 kV, UV resistant, UL/CSA-Style 10678/21179 Single-/Multicore



Technical data

- **Temperature range**
flexing -35°C to +90°C
fixed installation -40°C to +90°C
installation -20°C to +90°C
- Permissible conductor **operating temperature** +90°C
- **Nominal voltage**
VDE U₀/U 0,6/1 kV
UL 1000 V
- **Test voltage**
core/core 4000 V
- **Highest permissible voltage**
- DC:
Conductor/Conductor 1,8 kV
Conductor/Earth 0,9 kV
- AC: Conductor/Earth 0,7 kV
- Three-phase: Conductor/Conductor 1,2 kV
- **Minimum bending radius**
flexing 8x cable Ø
fixed installation 4x cable Ø
- **Torsion application**
+/- 140° per 1m
- **Approvals**
Singlecore UL Style 10678 (to 300 mm²)
Multicore UL Style 21179
cRUus
- **Flame test**
FT1, VW-1, IEC 60332-1-2

Cable structure

- Special bare copper conductor, acc. to IEC 60228
- Special heat-resistant insulation
- Core identification: see table
- Multiconductors cabled
- Sheath: special heat-resistant compound
- Sheath colour: black

Properties

- UV resistant
- Multi-climate operation
- Torsion tested
- Flame retardant
- Oil resistant
- Recyclable
- Easy to assemble

Note

For more information, especially on custom cables, please contact us: wind@helukabel.de

Application

The WK 103w-Torsion has been designed for flexible use, and specifically for torsional load in the cable loop of a wind power plant. The voltage level has been configured as 0.6/1 kV for all dimensions, which means that the cables can also be laid in parallel in compliance with UL standards. It is no longer necessary to separate the cable routes. The WK series has been successfully tested for more than 18,000 torsion cycles and thus offers optimum operational reliability far beyond the service life of the wind power plant.

☑ = Product conforms with Low-Voltage Directive 2014/35/EU.

Continuation ▶

HELUWIND® WK 103w-Torsion

0,6/1 kV, UV resistant, UL/CSA-Style 10678/21179 Single-/Multicore



Core identification black with white numbers, 3 cores and more with GN-YE

Part no.	No.cores x cross-sec. mm ²	AWG-No.	Outer Ø app. mm	Cop. weight kg / km	Weight app. kg / km
704809	4 G 0,34	22	7,1	29,0	86,0
704810	4 G 0,5	20	7,4	33,4	99,0
704811	6 G 0,5	20	8,6	51,2	121,0
704812	10 G 0,5	20	10,8	48,0	165,0
704813	12 G 0,5	20	11,1	84,0	208,0
704814	3 G 0,75	19	6,5	22,0	67,8
704815	4 G 0,75	19	7,9	29,0	100,0
704816	5 G 0,75	19	8,6	36,0	120,0
704817	7 G 0,75	19	9,5	51,0	137,4
704818	10 G 0,75	19	11,0	72,0	200,0
704819	12 G 0,75	19	11,8	87,0	220,0
704820	14 G 0,75	19	12,5	101,0	238,0
704821	16 G 0,75	19	13,2	116,0	271,0
704822	18 G 0,75	19	13,9	130,0	310,0
704823	21 G 0,75	19	15,2	152,0	380,0
704824	25 G 0,75	19	16,9	180,0	490,0
704825	32 G 0,75	19	18,2	231,0	560,0
704826	36 G 0,75	19	19,1	260,0	620,0
704827	40 G 0,75	19	20,5	288,0	729,0
704828	41 G 0,75	19	20,8	296,0	750,0
704829	50 G 0,75	19	23,5	441,0	990,0
704830	4 G 1	18	8,3	39,0	100,0
704831	5 G 1	18	9,0	48,0	110,0
704832	7 G 1	18	10,5	68,0	140,0
704833	10 G 1	18	13,0	96,0	220,0
704834	12 G 1	18	13,2	116,0	240,0
704835	14 G 1	18	13,4	135,0	280,0
704836	16 G 1	18	14,1	154,0	310,0
704837	18 G 1	18	15,1	173,0	360,0
704838	21 G 1	18	16,7	202,0	410,0
704839	25 G 1	18	18,4	240,0	500,0
704840	32 G 1	18	19,8	308,0	590,0
704841	36 G 1	18	20,6	346,0	700,0
704842	40 G 1	18	22,4	384,0	800,0
704843	41 G 1	18	22,4	394,0	810,0
704844	50 G 1	18	24,6	480,0	980,0
704845	2 x 1,5	16	7,9	29,0	75,0
703920	3 G 1,5	16	8,0	44,0	104,9
703921	4 G 1,5	16	8,9	58,0	132,0
703922	5 G 1,5	16	9,7	72,0	157,1
704366	7 G 1,5	16	12,0	101,0	230,8
704846	10 G 1,5	16	13,1	144,0	270,0
704847	12 G 1,5	16	14,3	173,0	360,0
704848	14 G 1,5	16	14,9	202,0	420,0
704849	16 G 1,5	16	15,7	231,0	450,0
704850	18 G 1,5	16	16,8	260,0	510,0
704851	21 G 1,5	16	17,8	303,0	590,0
704852	25 G 1,5	16	20,6	360,0	700,0
704853	32 G 1,5	16	22,2	460,0	900,0
704854	36 G 1,5	16	23,1	519,0	980,0

Dimensions and specifications may be changed without prior notice.

Core identification black with white numbers, 3 cores and more with GN-YE

Part no.	No.cores x cross-sec. mm ²	AWG-No.	Outer Ø app. mm	Cop. weight kg / km	Weight app. kg / km
704855	40 G 1,5	16	25,0	576,0	1030,0
704856	41 G 1,5	16	25,0	591,0	1050,0
704857	50 G 1,5	16	27,7	720,0	1200,0
710226	2 x 2,5	14	8,4	48,0	115,7
704267	3 G 2,5	14	8,9	72,0	150,8
703925	4 G 2,5	14	9,7	96,0	230,0
703926	5 G 2,5	14	10,9	120,0	237,9
704858	7 G 2,5	14	14,4	168,0	360,0
704859	10 G 2,5	14	15,8	240,0	480,0
704367	12 G 2,5	14	16,3	288,0	527,0
705040	19 G 2,5	14	21,0	456,0	590,0
704368	3 G 4	12	10,8	116,0	227,5
703930	4 G 4	12	12,0	154,0	286,8
704269	5 G 4	12	13,6	192,0	365,7
704860	7 G 4	12	15,9	269,0	489,0
704861	12 G 4	12	19,6	461,0	740,0
704862	3 G 6	10	13,1	173,0	340,0
704863	4 G 6	10	14,6	230,4	460,0
704864	5 G 6	10	16,3	288,0	566,4
704865	7 G 6	10	19,6	404,0	780,0
706318	3 G 10	8	16,4	288,0	540,0
704866	4 G 10	8	18,2	384,0	670,0
703932	5 G 10	8	20,1	480,0	851,2
704867	7 G 10	8	23,5	672,0	1150,0
712561	3 G 16	6	20,6	461,0	1083,2
704868	4 G 16	6	20,7	615,0	1180,7
703933	5 G 16	6	25,4	768,0	1348,1
704869	4 G 25	4	26,4	960,0	1576,2
704870	5 G 25	4	28,2	1200,0	1900,0
704871	4 G 35	2	31,4	1344,0	2286,0
704872	5 G 35	2	35,4	1680,0	2770,6
704873	4 G 50	1	36,7	1920,0	2800,0

Core identification black

Part no.	No.cores x cross-sec. mm ²	AWG-No.	Outer Ø app. mm	Cop. weight kg / km	Weight app. kg / km
706337	1 x 25	4	11,4	240,0	318,1
704287	1 x 35	2	12,9	336,0	454,4
704288	1 x 50	1	15,6	480,0	630,2
704289	1 x 70	2/0	17,9	672,0	876,8
704874	1 x 95	3/0	21,4	912,0	1230,0
704291	1 x 120	4/0	23,1	1152,0	1535,1
704875	1 x 150	300 kcmil	24,7	1440,0	2966,8
704293	1 x 185	350 kcmil	27,5	1776,0	2284,0
704294	1 x 240	450 kcmil	31,2	2304,0	2966,8
704295	1 x 300	500 kcmil	34,2	2880,0	3672,0
704876	1 x 400	750 kcmil	39,3	3840,0	4500,0

HELUWIND® WK 103w EMV D-Torsion

0,6/1 kV, screened, UV resistant, UL/CSA-Style 10678/21179 Single-/Multicore

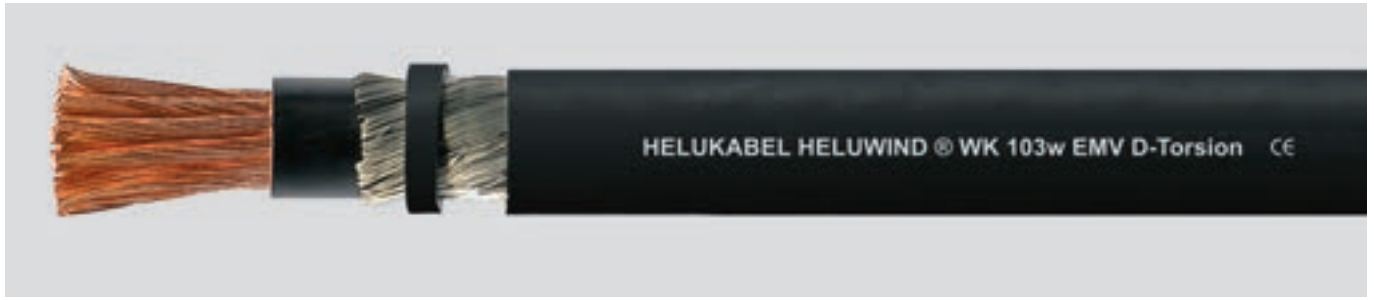

Technical data

- **Temperature range**
flexing -35°C to +90°C
fixed installation -40°C to +90°C
installation -20°C to +90°C
- Permissible conductor **operating temperature** +90°C
- **Nominal voltage**
VDE U₀/U 0,6/1 kV
UL 1000 V
- **Test voltage**
core/core 4000 V
core/screen 2000 V
- **Highest permissible voltage**
- DC:
Conductor/Conductor 1,8 kV
Conductor/Earth 0,9 kV
- AC: Conductor/Earth 0,7 kV
- Three phase: Conductor/Conductor 1,2 kV
- **Minimum bending radius**
flexing 10x cable Ø
fixed installation 5x cable Ø
- **Torsion application**
+/- 140° per 1m
- **Approvals**
Singlecore UL Style 10678
Multicore UL Style 21179
cRUus
- **Flame test**
FT1, VW-1, IEC 60332-1-2

Cable structure

- Special bare copper conductor, acc. to IEC 60228
- Special heat-resistant insulation
- Core identification: see table
- Multiconductors cabled
- EMC-screened types have tinned copper wrapping
- Sheath: special heat-resistant compound
- Sheath colour: black

Properties

- UV resistant
- Multi-climate operation
- Torsion tested
- Flame retardant
- Oil resistant
- Recyclable
- Easy to assemble

Note

For more information, especially on custom cables, please contact us: wind@helukabel.de

Application

The WK 103w EMV D-Torsion has been designed for flexible use, and specifically for torsional load in the cable loop of a wind power plant. The voltage level has been configured as 0.6/1 kV for all dimensions, which means that the cables can also be laid in parallel in compliance with UL standards. It is no longer necessary to separate the cable routes. The WK series has been successfully tested for more than 18,000 torsion cycles and thus offers optimum operational reliability far beyond the service life of the wind power plant.

EMC = Electromagnetic compatibility

To optimize the EMC features we recommend a large round contact of the copper wrapping on both ends.

CE = Product conforms with Low-Voltage Directive 2014/35/EU.

Continuation ▶

HELUWIND® WK 103w EMV D-Torsion

0,6/1 kV, screened, UV resistant, UL/CSA-Style 10678/21179 Single-/Multicore



Core identification black with white numbers, 3 cores and more with GN-YE

Part no.	No.cores x cross-sec. mm ²	AWG-No.	Outer Ø app. mm	Cop. weight kg / km	Weight app. kg / km
704752	4 G 0,34	22	7,7	32,0	91,0
704755	4 G 0,5	20	8,0	37,8	105,0
704758	6 G 0,5	20	9,2	53,6	130,0
704762	10 G 0,5	20	11,4	73,0	170,0
704763	12 G 0,5	20	11,7	88,4	220,0
706599	2 x 0,75	19	6,7	36,0	70,5
704764	3 G 0,75	19	7,7	43,2	97,0
704765	4 G 0,75	19	7,8	52,6	101,6
704767	5 G 0,75	19	9,0	63,0	145,0
704369	7 G 0,75	19	9,7	82,8	162,6
705822	3 x 2 x 0,75	19	11,5	73,0	211,0
704769	4 x 2 x 0,75	19	12,7	91,0	211,0
704768	8 G 0,75	19	10,7	93,0	220,0
704771	12 G 0,75	19	12,2	126,9	257,5
704774	18 G 0,75	19	14,4	179,0	400,0
704775	12 x 2 x 0,75	19	17,6	223,0	520,0
704268	25 G 0,75	19	17,8	256,0	547,2
705228	40 G 0,75	19	21,2	385,0	805,4
704778	41 G 0,75	19	21,2	370,8	795,0
704779	50 G 0,75	19	23,5	441,0	900,0
704784	2 x 1,5	16	6,8	44,0	86,0
704785	3 G 1,5	16	8,8	68,1	133,0
704786	4 G 1,5	16	9,4	87,9	159,0
704788	5 G 1,5	16	10,3	104,0	195,0
704790	7 G 1,5	16	11,6	140,8	247,0
704792	12 G 1,5	16	14,7	226,8	410,0
704793	3 G 2,5	14	10,4	104,4	210,0
704794	4 G 2,5	14	10,5	132,7	218,4
704795	5 G 2,5	14	12,3	161,1	288,0
704796	7 G 2,5	14	13,5	223,1	355,1
704797	12 G 2,5	14	16,7	350,6	560,0
705039	19 G 2,5	14	21,7	561,0	638,0
704798	5 G 4	12	14,0	237,4	382,0
704799	7 G 4	12	16,3	325,0	582,0
704800	12 G 4	12	20,0	532,1	806,0
704801	5 G 6	10	17,4	341,0	640,0
704802	4 G 10	8	17,8	445,6	727,0
704803	5 G 10	8	20,7	550,2	935,0
704804	4 G 16	6	21,1	692,2	1072,0
704805	5 G 16	6	26,2	881,0	1667,3
704806	4 G 25	4	26,0	1059,0	1664,0
704807	5 G 25	4	28,6	1327,0	2014,0
704808	4 G 50	1	37,0	2080,0	3200,0

Core identification acc. to DIN 47100

Part no.	No.cores x cross-sec. mm ²	AWG-No.	Outer Ø app. mm	Cop. weight kg / km	Weight app. kg / km
704749	2 x 2 x 0,25	24	8,9	27,0	90,0
704750	4 x 2 x 0,25	24	9,9	39,0	115,0
704751	5 x 2 x 0,25	24	11,1	46,0	130,0
704753	2 x 2 x 0,34	22	9,6	35,0	110,0
704754	4 x 2 x 0,34	22	11,0	47,0	130,0
704756	2 x 2 x 0,5	20	9,8	39,0	115,0
704757	4 x 0,5	20	8,0	37,8	105,0
704759	6 x 0,5	20	9,2	53,6	130,0
704761	4 x 2 x 0,5	20	11,3	69,5	184,1
704766	2 x 2 x 0,75	19	10,4	54,0	130,0
705829	3 x 2 x 0,75	19	11,5	73,0	172,0
704770	4 x 2 x 0,75	19	12,7	91,0	214,5
704772	12 x 0,75	19	12,2	126,9	257,5
704773	8 x 2 x 0,75	19	17,1	170,0	410,0
704776	12 x 2 x 0,75	19	17,6	223,0	520,0
704777	32 x 0,75	19	18,8	294,0	610,0
704780	4 x 1	18	8,7	56,0	110,0
704781	6 x 1	18	10,2	82,0	150,0
704782	8 x 1	18	11,7	106,0	210,0
704783	12 x 1	18	13,3	150,0	280,0
704787	2 x 2 x 1,5	16	12,1	90,0	180,0
704789	3 x 2 x 1,5	16	14,0	120,0	235,0
704791	4 x 2 x 1,5	16	14,6	150,0	210,0

Core identification black

Part no.	No.cores x cross-sec. mm ²	AWG-No.	Outer Ø app. mm	Cop. weight kg / km	Weight app. kg / km
706601	4 x 0,75	19	7,8	52,6	101,6
703147	1 x 70	2/0	19,8	739,0	950,0
703148	1 x 95	3/0	22,5	989,0	1280,0
703041	1 x 120	4/0	23,0	1242,0	1742,6
703149	1 x 150	300 kcmil	27,5	1548,0	2000,0
703150	1 x 185	350 kcmil	27,8	1904,0	2395,8
703151	1 x 240	450 kcmil	31,6	2451,0	3150,0
703152	1 x 300	500 kcmil	34,4	3027,0	3920,0

Dimensions and specifications may be changed without prior notice.

HELUWIND® WK 103k-Torsion

0,6/1 kV, UV resistant, UL/CSA-Style 10269/2570 Single-/Multicore



Technical data

- **Temperature range**
flexing -40°C to +80°C
fixed installation -40°C to +80°C
installation -40°C to +80°C
- **Nominal voltage**
VDE U₀/U 0,6/1 kV
UL 1000 V
- **Test voltage**
core/core 4000 V
- **Highest permissible voltage**
- DC:
Conductor/Conductor 1,8 kV
Conductor/Earth 0,9 kV
- AC: Conductor/Earth 0,7 kV
- Three phase: Conductor/Conductor 1,2 kV
- **Minimum bending radius**
flexing 8x cable Ø
fixed installation 4x cable Ø
- **Torsion application**
+/- 140° per 1m
- **Approvals**
Singlecore UL Style 10269
Multicore UL Style 2570
cRUus
- **Flame test**
FT1, VW-1, IEC 60332-1-2

Cable structure

- Special bare copper conductor, acc. to IEC 60228
- Special insulation material flexible at low temperatures
- Core identification: see table
- Multiconductors cabled
- Special sheath compound flexible at low temperatures
- Sheath: colour black

Properties

- UV resistant
- Multi-climate operation
- Torsion tested
- Flame retardant
- Oil resistant
- Recyclable
- Easy to assemble

Note

For more information, especially on custom cables, please contact us: wind@helukabel.de

Application

The WK 103k-Torsion has been designed for flexible use, and specifically for torsional load in the cable loop of a wind power plant. The voltage level has been configured as 0.6/1 kV for all dimensions, which means that the cables can also be laid in parallel in compliance with UL standards. It is no longer necessary to separate the cable routes. The WK series has been successfully tested for more than 18,000 torsion cycles and thus offers optimum operational reliability far beyond the service life of the wind power plant.

CE = Product conforms with Low-Voltage Directive 2014/35/EU.

Continuation ▶

HELWIND® WK 103k-Torsion

0,6/1 kV, UV resistant, UL/CSA-Style 10269/2570 Single-/Multicore



Core identification black with white numbers, 3 cores and more with GN-YE

Part no.	No.cores x cross-sec. mm²	AWG-No.	Outer Ø app. mm	Cop. weight kg / km	Weight app. kg / km
704941	4 G 0,5	20	7,4	33,4	99,0
704942	6 G 0,5	20	8,6	51,2	121,0
704943	10 G 0,5	20	10,8	48,0	165,0
704944	12 G 0,5	20	11,1	84,0	208,0
704945	3 G 0,75	19	7,3	22,0	77,0
704946	4 G 0,75	19	7,9	29,0	100,0
704947	5 G 0,75	19	8,6	36,0	120,0
704948	7 G 0,75	19	10,0	51,0	170,0
704949	10 G 0,75	19	11,0	72,0	200,0
704950	12 G 0,75	19	11,8	87,0	220,0
704951	14 G 0,75	19	12,5	101,0	238,0
704952	16 G 0,75	19	13,2	116,0	271,0
704953	18 G 0,75	19	13,9	130,0	310,0
704954	21 G 0,75	19	15,2	152,0	380,0
704955	25 G 0,75	19	16,9	180,0	490,0
704956	32 G 0,75	19	18,2	231,0	560,0
704957	36 G 0,75	19	19,1	260,0	620,0
704958	40 G 0,75	19	20,5	288,0	729,0
704959	41 G 0,75	19	20,8	296,0	729,0
704960	50 G 0,75	19	23,5	441,0	990,0
704961	4 G 1	18	8,3	39,0	100,0
704962	5 G 1	18	9,0	48,0	110,0
704963	7 G 1	18	10,5	68,0	140,0
704964	10 G 1	18	13,0	96,0	220,0
704965	12 G 1	18	13,2	116,0	240,0
704966	14 G 1	18	13,4	135,0	280,0
704967	16 G 1	18	14,1	154,0	310,0
704968	18 G 1	18	15,1	173,0	360,0
704969	21 G 1	18	16,7	202,0	410,0
704970	25 G 1	18	18,4	240,0	500,0
704971	32 G 1	18	19,8	308,0	590,0
704972	36 G 1	18	20,6	346,0	700,0
704973	40 G 1	18	22,4	384,0	800,0
704974	41 G 1	18	22,4	394,0	810,0
704975	50 G 1	18	24,6	480,0	980,0
704976	2 x 1,5	16	7,9	29,0	75,0
704977	3 G 1,5	16	8,0	44,0	110,0
704978	4 G 1,5	16	8,9	58,0	131,0
704979	5 G 1,5	16	9,7	72,0	165,0
704980	7 G 1,5	16	12,0	101,0	210,0
704981	10 G 1,5	16	13,1	144,0	270,0
704982	12 G 1,5	16	14,3	173,0	360,0
704983	14 G 1,5	16	14,9	202,0	420,0
704984	16 G 1,5	16	15,7	231,0	450,0
704985	18 G 1,5	16	16,8	260,0	510,0
704986	21 G 1,5	16	17,8	303,0	590,0
704987	25 G 1,5	16	20,6	360,0	700,0
704988	32 G 1,5	16	22,2	460,0	900,0
704989	36 G 1,5	16	23,1	519,0	980,0
704990	40 G 1,5	16	25,0	576,0	1030,0

Core identification black with white numbers, 3 cores and more with GN-YE

Part no.	No.cores x cross-sec. mm²	AWG-No.	Outer Ø app. mm	Cop. weight kg / km	Weight app. kg / km
704991	41 G 1,5	16	25,0	591,0	1050,0
704992	50 G 1,5	16	27,7	720,0	1200,0
704993	3 G 2,5	14	8,9	72,0	151,0
704994	4 G 2,5	14	9,7	96,0	230,0
704995	5 G 2,5	14	10,9	120,0	250,0
704996	7 G 2,5	14	14,4	168,0	360,0
704997	10 G 2,5	14	15,8	240,0	480,0
704998	12 G 2,5	14	16,3	288,0	560,0
705038	19 G 2,5	14	20,4	456,0	591,0
704999	3 G 4	12	10,8	116,0	250,0
705000	4 G 4	12	12,0	154,0	286,8
705001	5 G 4	12	13,6	192,0	370,0
705002	7 G 4	12	15,9	269,0	530,0
705003	12 G 4	12	19,6	461,0	740,0
705004	3 G 6	10	13,1	173,0	340,0
705005	4 G 6	10	14,6	231,0	460,0
705006	5 G 6	10	16,2	288,0	566,4
705007	7 G 6	10	19,6	404,0	780,0
705008	4 G 10	8	17,4	384,0	670,0
705009	5 G 10	8	20,1	480,0	870,0
705010	7 G 10	8	23,5	672,0	1150,0
705011	4 G 16	6	20,7	615,0	1000,0
705012	5 G 16	6	25,4	768,0	1250,0
705013	4 G 25	4	26,5	960,0	1580,0
705014	5 G 25	4	28,2	1200,0	1900,0
705016	4 G 35	2	31,4	1344,0	2286,0
705017	5 G 35	2	35,4	1680,0	2600,0
705018	4 G 50	1	36,7	1920,0	2800,0
704940	4 G 70	2/0	46,0	2688,0	3600,0

Core identification black

Part no.	No.cores x cross-sec. mm²	AWG-No.	Outer Ø app. mm	Cop. weight kg / km	Weight app. kg / km
705015	1 x 35	2	12,9	336,0	460,0
705019	1 x 70	2/0	17,9	672,0	1580,0
705020	1 x 95	3/0	21,9	912,0	1230,0
705021	1 x 120	4/0	23,1	1152,0	1540,0
705022	1 x 150	300 kcmil	27,2	1440,0	1870,0
705023	1 x 185	350 kcmil	27,5	1776,0	2284,0
705024	1 x 240	450 kcmil	31,2	2304,0	2966,8
705025	1 x 300	500 kcmil	35,0	2880,0	3730,0
705026	1 x 400	750 kcmil	39,3	3840,0	4500,0

Dimensions and specifications may be changed without prior notice.

HELUWIND® WK 103k EMV D-Torsion

0,6/1 kV, screened, UV resistant, UL/CSA-Style 10269/2570 Single-/Multicore



Technical data

- **Temperature range**
flexing -40°C to +80°C
fixed installation -40°C to +80°C
installation -40°C to +80°C
- **Nominal voltage**
VDE U₀/U 0,6/1 kV
UL 1000 V
- **Test voltage**
core/core 4000 V
core/screen 2000 V
- **Highest permissible voltage**
 - DC:
Conductor/Conductor 1,8 kV
Conductor/Earth 0,9 kV
 - AC: Conductor/Earth 0,7 kV
 - Three phase: Conductor/Conductor 1,2 kV
- **Minimum bending radius**
flexing 10x cable Ø
fixed installation 5x cable Ø
- **Torsion application**
+/- 140° per 1m
- **Approvals**
Singlecore UL Style 10269
Multicore UL Style 2570
cRUus
- **Flame test**
FT1, VW-1, IEC 60332-1-2

Cable structure

- Special bare copper conductor, acc. to IEC 60228
- Special flexible insulation material for low temperatures
- Core identification: see table
- Multiconductors cabled
- EMC-screened types have tinned copper wrapping
- Special sheath compound flexible at low temperatures
- Sheath colour: black

Properties

- UV resistant
- Multi-climate operation
- Torsion tested
- Flame retardant
- Oil resistant
- Recyclable
- Easy to assemble

Note

For more information, especially on custom cables, please contact us: wind@helukabel.de

Application

The WK 103k EMV D-Torsion has been designed for flexible use, and specifically for torsional load in the cable loop of a wind power plant. The voltage level has been configured as 0.6/1 kV for all dimensions, which means that the cables can also be laid in parallel in compliance with UL standards. It is no longer necessary to separate the cable routes. The WK series has been successfully tested for more than 18,000 torsion cycles and thus offers optimum operational reliability far beyond the service life of the wind power plant.

EMC = Electromagnetic compatibility

To optimize the EMC features we recommend a large round contact of the copper wrapping on both ends.

CE = Product conforms with Low-Voltage Directive 2014/35/EU.

Continuation ▶

HELUWIND® WK 103k EMV D-Torsion

0,6/1 kV, screened, UV resistant, UL/CSA-Style 10269/2570 Single-/Multicore



Core identification black with white numbers, 3 cores and more with GN-YE

Part no.	No. cores x cross-sec. mm ²	AWG-No.	Outer Ø app. mm	Cop. weight kg / km	Weight app. kg / km
704880	4 G 0,34	22	7,7	32,0	91,0
704883	4 G 0,5	20	8,0	37,8	105,0
704886	6 G 0,5	20	9,2	53,6	130,0
704890	10 G 0,5	20	11,4	73,0	170,0
704891	12 G 0,5	20	11,7	88,4	220,0
704892	3 G 0,75	19	7,7	43,2	97,0
704893	4 G 0,75	19	8,3	52,6	122,0
704895	5 G 0,75	19	9,0	63,0	145,0
704896	7 G 0,75	19	9,7	82,8	200,0
704898	4 x 2 x 0,75	19	12,7	91,0	211,0
704897	8 G 0,75	19	10,7	93,0	220,0
704900	12 G 0,75	19	12,2	126,9	257,5
704903	18 G 0,75	19	14,4	179,0	400,0
704904	12 x 2 x 0,75	19	17,6	223,0	520,0
704906	25 G 0,75	19	17,8	256,0	552,0
704908	41 G 0,75	19	21,2	370,8	795,0
704909	50 G 0,75	19	23,5	441,0	900,0
704914	2 x 1,5	16	6,8	44,0	86,0
704915	3 G 1,5	16	8,8	68,1	133,0
704916	4 G 1,5	16	9,4	87,9	159,0
704918	5 G 1,5	16	10,3	104,0	195,0
704920	7 G 1,5	16	11,9	140,8	247,0
704922	12 G 1,5	16	14,7	229,0	410,0
704923	3 G 2,5	14	10,4	104,4	210,0
704924	4 G 2,5	14	11,2	132,8	264,0
704925	5 G 2,5	14	12,3	161,1	288,0
704926	7 G 2,5	14	14,8	223,1	411,0
704927	12 G 2,5	14	16,7	350,6	560,0
705037	19 G 2,5	14	21,7	561,0	638,0
704928	5 G 4	12	13,6	237,4	382,0
704929	7 G 4	12	16,3	325,0	582,0
704930	12 G 4	12	20,0	532,1	806,0
704931	5 G 6	10	17,4	341,0	640,0
704932	4 G 10	8	17,8	445,6	727,0
704933	5 G 10	8	19,8	550,2	935,0
704934	4 G 16	6	21,1	692,2	1072,0
704935	5 G 16	6	24,4	854,4	1330,0
704936	4 G 25	4	26,0	1059,0	1664,0
704937	5 G 25	4	28,6	1327,0	2014,0
704938	4 G 50	1	37,0	2080,0	3200,0

Core identification acc. to DIN 47100

Part no.	No. cores x cross-sec. mm ²	AWG-No.	Outer Ø app. mm	Cop. weight kg / km	Weight app. kg / km
704877	2 x 2 x 0,25	24	8,9	27,0	90,0
704878	4 x 2 x 0,25	24	9,9	39,0	115,0
704879	5 x 2 x 0,25	24	11,1	46,0	130,0
704881	2 x 2 x 0,34	22	9,6	35,0	110,0
704882	4 x 2 x 0,34	22	11,0	47,0	130,0
704884	2 x 2 x 0,5	20	9,8	39,0	115,0
704885	4 x 0,5	20	8,0	37,8	105,0
704887	6 x 0,5	20	9,2	53,6	130,0
704889	8 x 0,5	20	11,3	42,0	150,0
704888	4 x 2 x 0,5	20	11,5	69,2	190,0
704894	2 x 2 x 0,75	19	10,4	54,0	130,0
704899	4 x 2 x 0,75	19	12,7	91,0	211,0
704901	12 x 0,75	19	12,2	126,9	257,5
704902	8 x 2 x 0,75	19	17,1	170,0	410,0
704905	12 x 2 x 0,75	19	17,6	223,0	520,0
704907	32 x 0,75	19	18,8	294,0	610,0
704910	4 x 1	18	8,7	56,0	110,0
704911	6 x 1	18	10,2	82,0	150,0
704912	8 x 1	18	11,7	106,0	210,0
704913	12 x 1	18	13,3	150,0	280,0
704917	2 x 2 x 1,5	16	12,1	90,0	180,0
704919	3 x 2 x 1,5	16	14,0	120,0	235,0
704921	4 x 2 x 1,5	16	14,6	150,0	210,0

Core identification black

Part no.	No. cores x cross-sec. mm ²	AWG-No.	Outer Ø app. mm	Cop. weight kg / km	Weight app. kg / km
78177	1 x 70	2/0	19,8	739,0	950,0
74006	1 x 95	3/0	21,2	959,0	1285,8
78178	1 x 120	4/0	25,0	1250,0	1644,2
78179	1 x 150	300 kcmil	28,4	1740,0	2000,0
78180	1 x 185	350 kcmil	30,1	1904,0	2450,0
703328	1 x 240	450 kcmil	32,5	2451,0	2953,3
704939	1 x 300	500 kcmil	39,0	3027,0	3920,0

Dimensions and specifications may be changed without prior notice.

HELUWIND® WK 135-Torsion

0,6/1 kV, 90°C (80°C acc. to UL), suitable offshore, UV resistant,
UL/CSA-Style 10553/20234 Single-/Multicore



Technical data

- **Temperature range**
flexing -40°C to +90°C
fixed installation -40°C to +90°C
acc. to UL up to +80°C
- Permissible conductor **operating temperature** +90°C
- **Nominal voltage**
VDE U₀/U 0,6/1 kV
UL 1000 V
- **Test voltage**
core/core 4000 V
- **Highest permissible voltage**
- DC:
Conductor/Conductor 1,8 kV
Conductor/Earth 0,9 kV
- AC: Conductor/Earth 0,7 kV
- Three phase: Conductor/Conductor 1,2 kV
- **Minimum bending radius**
flexing 8x cable Ø
fixed installation 4x cable Ø
- **Torsion application**
+/- 150° per 1m
- **Approvals**
Singlecore UL Style 10553
Multicore UL Style 20234
cRUus
- **Flame test**
FT1, IEC 60332-3-24
UL 758, Cable flame test
- **Halogen-free**
IEC 60754-1
- **Smoke density**
IEC 61034-1+2
- **Oil**
acc. to oil res II + IEC 60502-1
- **WTTC** in preparation

Cable structure

- Special bare copper conductor,
acc. to IEC 60228
- Insulation: special compound
- Core identification: see table
- Multiconductors cabled
- Sheath: special compound
- Sheath colour: black

Properties

- Halogen-free
- Extremely abrasion resistant
- Low adhesion
- High flame retardant
- Torsion tested
- Suitable for offshore applications
- Extremely oil resistant
- UV resistant
- Recyclable
- Multi-climate operation
- Designed for CCV application
- Easy to assemble

Note

For more information, especially on custom cables, please contact us: wind@helukabel.de

Application

The WK 135-Torsion has been designed for flexible use, and specifically for torsional load in the cable loop of a wind power plant. The voltage level has been configured as 0.6/1 kV for all dimensions, which means that the cables can also be laid in parallel in compliance with UL standards. It is no longer necessary to separate the cable routes. Thanks to its highly durable sheath and absence of halogen, this cable is ideal for use in offshore wind power plants. The WK series has been successfully tested for more than 18,000 torsion cycles and thus offers optimum operational reliability far beyond the service life of the wind power plant. Advantages of WK 135-Torsion over H07BN4-F: Fire behaviour in accordance with IEC 60332-3-24, increased wear resistance.

☑️ = Product conforms with Low-Voltage Directive 2014/35/EU.

Continuation ▶

HELUWIND® WK 135-Torsion

0,6/1 kV, 90°C (80°C acc. to UL), suitable offshore, UV resistant,
UL/CSA-Style 10553/20234 Single-/Multicore



Core identification black with white numbers, 3 cores and more with GN-YE

Part no.	No. cores x cross-sec. mm ²	AWG-No.	Outer Ø app. mm	Cop. weight kg / km	Weight app. kg / km
703668	4 G 0,34	22	7,1	29,0	88,0
703669	4 G 0,5	20	7,4	34,0	98,0
703671	6 G 0,5	20	8,6	49,0	122,0
703289	10 G 0,5	20	10,8	48,0	165,0
703673	12 G 0,5	20	11,1	84,0	208,0
703291	3 G 0,75	19	7,3	22,0	77,0
703292	4 G 0,75	19	7,9	29,0	100,0
703293	5 G 0,75	19	8,6	36,0	120,0
703294	7 G 0,75	19	10,0	51,0	170,0
704699	10 G 0,75	19	11,0	72,0	200,0
703295	12 G 0,75	19	11,8	87,0	220,0
704700	14 G 0,75	19	12,5	101,0	238,0
704701	16 G 0,75	19	13,2	116,0	271,0
704702	18 G 0,75	19	13,9	130,0	310,0
704703	21 G 0,75	19	15,2	152,0	380,0
703296	25 G 0,75	19	16,9	180,0	490,0
704704	32 G 0,75	19	18,2	231,0	560,0
704705	36 G 0,75	19	19,1	260,0	620,0
704706	40 G 0,75	19	20,5	288,0	729,0
704707	4 G 1	18	8,3	39,0	100,0
704708	5 G 1	18	9,0	48,0	110,0
704709	7 G 1	18	10,1	68,0	140,0
704710	10 G 1	18	13,0	96,0	220,0
704711	12 G 1	18	12,9	116,0	240,0
704712	14 G 1	18	13,4	135,0	280,0
704713	16 G 1	18	14,1	154,0	310,0
704714	18 G 1	18	15,1	173,0	360,0
704715	21 G 1	18	16,7	202,0	410,0
704716	25 G 1	18	18,4	240,0	500,0
704717	32 G 1	18	19,8	308,0	590,0
704718	36 G 1	18	20,6	346,0	700,0
704719	40 G 1	18	22,4	384,0	800,0
704720	41 G 1	18	22,4	394,0	810,0
704721	50 G 1	18	24,6	480,0	980,0
704722	2 x 1,5	16	7,9	29,0	75,0
703298	3 G 1,5	16	8,4	44,0	112,7
703299	4 G 1,5	16	9,0	58,0	137,5
703300	5 G 1,5	16	9,9	72,0	164,6
703301	7 G 1,5	16	11,6	100,8	210,0
704723	10 G 1,5	16	13,1	144,0	270,0
703302	12 G 1,5	16	14,0	172,8	360,0
704724	14 G 1,5	16	14,9	202,0	420,0
704725	16 G 1,5	16	15,7	231,0	450,0
704727	21 G 1,5	16	17,8	303,0	590,0
704726	18 G 1,5	16	16,8	260,0	510,0
704728	25 G 1,5	16	20,6	360,0	700,0
704729	32 G 1,5	16	22,2	460,0	900,0
704730	36 G 1,5	16	23,1	519,0	980,0
704731	40 G 1,5	16	25,0	576,0	1030,0
704732	41 G 1,5	16	25,0	591,0	1050,0
704733	50 G 1,5	16	27,7	720,0	1200,0
703303	3 G 2,5	14	9,3	72,0	151,4
703304	4 G 2,5	14	10,1	96,0	189,3
703305	5 G 2,5	14	11,1	120,0	227,6
703306	7 G 2,5	14	13,2	168,0	360,0

Dimensions and specifications may be changed without prior notice.

Core identification black with white numbers, 3 cores and more with GN-YE

Part no.	No. cores x cross-sec. mm ²	AWG-No.	Outer Ø app. mm	Cop. weight kg / km	Weight app. kg / km
704734	10 G 2,5	14	15,8	240,0	480,0
703307	12 G 2,5	14	16,3	288,0	527,0
705046	19 G 2,5	14	21,0	456,0	591,0
704735	3 G 4	12	10,6	116,0	217,9
704736	4 G 4	12	13,6	153,6	315,8
703308	5 G 4	12	13,2	192,0	332,9
703309	7 G 4	12	15,9	269,0	530,0
703310	12 G 4	12	19,6	461,0	740,0
704737	3 G 6	10	12,5	173,0	327,9
704738	4 G 6	10	13,6	231,0	460,0
704471	5 G 6	10	16,3	288,0	538,6
704739	7 G 6	10	19,6	404,0	780,0
703311	4 G 10	8	18,6	384,0	670,0
703312	5 G 10	8	20,9	480,0	885,6
704740	7 G 10	8	23,5	672,0	1150,0
703313	4 G 16	6	23,2	614,4	1100,0
703314	5 G 16	6	25,4	768,0	1382,1
707651	3 G 70	2/0	36,8	2016,0	3374,4
703315	4 G 25	4	25,9	960,0	1594,2
703316	5 G 25	4	29,7	1200,0	1990,0
704742	4 G 35	2	30,6	1344,0	2261,3
704743	5 G 35	2	34,5	1680,0	2727,4
704744	4 G 50	1	32,8	1920,0	3248,0
705108	4 G 95	3/0	45,4	3648,0	1650,0

Core identification acc. to DIN VDE 0293-308

Part no.	No. cores x cross-sec. mm ²	AWG-No.	Outer Ø app. mm	Cop. weight kg / km	Weight app. kg / km
707454	4 G 2,5	14	10,1	96,0	185,0
707456	5 G 6	10	16,5	288,0	540,0
707463	4 G 25	4	26,2	960,0	1650,0
707455	4 G 35	2	30,6	1344,0	2100,0
707464	5 G 35	2	34,5	1680,0	2700,0
707457	5 G 70	2/0	45,7	3360,0	5414,0
708436	4 G 95	3/0	45,4	3648,0	5300,0
708687	5 G 95	3/0	51,0	4560,0	6770,0

Core identification black

Part no.	No. cores x cross-sec. mm ²	AWG-No.	Outer Ø app. mm	Cop. weight kg / km	Weight app. kg / km
707129	1 x 25	4	11,4	240,0	476,0
704741	1 x 35	2	12,9	336,0	454,0
703317	1 x 70	2/0	17,7	672,0	894,1
703318	1 x 95	3/0	19,2	912,0	1222,0
703319	1 x 120	4/0	21,3	1152,0	1314,0
703320	1 x 150	300 kcmil	24,7	1440,0	1814,2
703321	1 x 185	350 kcmil	25,7	1776,0	2186,5
703322	1 x 240	450 kcmil	30,2	2304,0	2810,5
703323	1 x 300	500 kcmil	32,8	2880,0	3517,3
704745	1 x 400	750 kcmil	39,3	3840,0	4500,0

HELUWIND® WK 135 EMV D-Torsion

0,6/1 kV, 90°C (80°C acc. to UL), suitable offshore, screened,
UV resistant, UL/CSA-Style 10553/20234 Single-/Multicore



Technical data

- **Temperature range**
flexing -40°C to +90°C
fixed installation -40°C to +90°C
acc. to UL up to +80°C
- **Permissible conductor operating temperature** +90°C
- **Nominal voltage**
VDE U₀/U 0,6/1 kV
UL 1000 V
- **Test voltage**
core/core 4000 V
core/screen 2000 V
- **Highest permissible voltage**
- DC:
Conductor/Conductor 1,8 kV
Conductor/Earth 0,9 kV
- AC: Conductor/Earth 0,7 kV
- Three phase: Conductor/Conductor 1,2 kV
- **Minimum bending radius**
flexing 10x cable Ø
fixed installation 5x cable Ø
- **Torsion application**
+/- 150° per 1m
- **Approvals**
Singlecore UL Style 10553
Multicore UL Style 20234
cRUus
- **Flame test**
FT1, IEC 60332-3-24
UL 758, Cable flame test
- **Halogen-free**
IEC 60754-1
- **Smoke density**
IEC 61034-1+2
- **Oil**
acc. to oil res II + IEC 60502-1
- **WTTC** in preparation

Application

The WK 135 EMV D-Torsion has been designed for flexible use, and specifically for torsional load in the cable loop of a wind power plant. The voltage level has been configured as 0.6/1 kV for all dimensions, which means that the cables can also be laid in parallel in compliance with UL standards. It is no longer necessary to separate the cable routes. Thanks to its highly durable sheath and absence of halogen, this cable is ideal for use in offshore wind power plants. The WK series has been successfully tested for more than 18,000 torsion cycles and thus offers optimum operational reliability far beyond the service life of the wind power plant. Advantages of WK 135-Torsion over H07BN4-F: Fire behaviour in accordance with IEC 60332-3-24, increased wear resistance.

EMC = Electromagnetic compatibility

To optimize the EMC features we recommend a large round contact of the copper wrapping on both ends.

CE = Product conforms with Low-Voltage Directive 2014/35/EU.

Cable structure

- Special bare copper conductor, acc. to IEC 60228
- Insulation: special compound
- Core identification: see table
- Multiconductors cabled
- EMC-screened types have tinned copper wrapping
- Sheath: special compound
- Sheath colour: black

Properties

- Halogen-free
- Extremely abrasion resistant
- Low adhesion
- High flame retardant
- Torsion tested
- Suitable for offshore applications
- Extremely oil resistant
- UV resistant
- Recyclable
- Multi-climate operation
- Designed for CCV application
- Easy to assemble

Note

For more information, especially on custom cables, please contact us: wind@helukabel.de

Continuation ▶

HELWIND® WK 135 EMV D-Torsion

0,6/1 kV, 90°C (80°C acc. to UL), suitable offshore, screened,
UV resistant, UL/CSA-Style 10553/20234 Single-/Multicore



Core identification black with white numbers, 3 cores and more with GN-YE

Part no.	No.cores x cross-sec. mm ²	AWG-No.	Outer Ø app. mm	Cop. weight kg / km	Weight app. kg / km
703285	4 G 0,34	22	7,7	32,0	91,0
703286	4 G 0,5	20	8,0	36,5	100,9
703288	6 G 0,5	20	9,2	53,6	130,0
703287	8 G 0,5	20	11,5	69,2	190,0
703672	10 G 0,5	20	11,4	73,0	170,0
703290	12 G 0,5	20	11,7	88,4	220,0
703674	3 G 0,75	19	7,7	43,2	97,0
703675	4 G 0,75	19	8,3	52,6	122,0
703676	5 G 0,75	19	9,0	63,0	145,0
703677	7 G 0,75	19	10,2	82,8	177,7
703678	8 G 0,75	19	10,7	93,0	220,0
704685	4 x 2 x 0,75	19	12,7	91,0	220,0
703679	12 G 0,75	19	12,2	126,9	257,5
703680	18 G 0,75	19	14,5	179,0	358,6
703681	25 G 0,75	19	17,3	238,3	560,0
703682	41 G 0,75	19	21,2	358,0	805,8
704038	50 G 0,75	19	23,5	441,0	998,2
707006	25 G 1	18	19,0	304,0	593,0
704167	2 x 1,5	16	6,8	44,0	85,1
703684	3 G 1,5	16	8,9	68,0	133,0
703685	4 G 1,5	16	9,6	87,9	159,0
703686	5 G 1,5	16	10,4	104,4	195,0
703687	7 G 1,5	16	11,9	140,8	248,5
703688	12 G 1,5	16	14,9	226,8	410,0
703689	3 G 2,5	14	9,8	104,4	210,0
703690	4 G 2,5	14	10,6	132,7	216,1
703691	5 G 2,5	14	12,3	161,0	253,4
703692	7 G 2,5	14	13,7	223,1	347,5
703693	12 G 2,5	14	16,7	350,6	560,0
705045	19 G 2,5	14	21,7	561,0	638,0
703694	5 G 4	12	13,4	227,0	361,2
703695	7 G 4	12	16,4	325,0	582,0
703696	12 G 4	12	20,0	532,1	806,0
704697	5 G 6	10	17,4	341,0	640,0
703697	4 G 10	8	17,8	445,6	727,0
703698	5 G 10	8	19,8	550,2	935,0
703699	4 G 16	6	23,6	696,5	1176,0
703700	5 G 16	6	26,2	863,1	1428,0
703701	4 G 25	4	26,7	1059,4	1671,6
703702	5 G 25	4	30,1	1327,5	2108,0
704698	4 G 50	1	36,0	2070,0	3150,0

Core identification acc. to DIN 47100

Part no.	No.cores x cross-sec. mm ²	AWG-No.	Outer Ø app. mm	Cop. weight kg / km	Weight app. kg / km
704675	2 x 2 x 0,25	24	8,9	27,0	90,0
704676	4 x 2 x 0,25	24	9,9	39,0	115,0
704677	5 x 2 x 0,25	24	11,1	46,0	130,0
704678	2 x 2 x 0,34	22	9,6	35,0	110,0
704679	4 x 2 x 0,34	22	11,0	47,0	130,0
704680	4 x 0,5	20	9,8	39,0	115,0
704681	4 x 0,5	20	8,0	37,8	105,0
704682	6 x 0,5	20	9,2	53,6	130,5
704683	4 x 2 x 0,5	20	11,3	72,0	150,0
704684	2 x 2 x 0,75	19	10,4	54,0	130,0
707638	3 x 2 x 0,75	19	11,7	81,0	188,0
704040	4 x 2 x 0,75	19	12,7	91,0	218,1
704686	12 x 0,75	19	12,2	126,9	257,5
704687	8 x 2 x 0,75	19	17,1	170,0	410,0
704039	12 x 2 x 0,75	19	17,6	223,0	513,2
704689	32 x 0,75	19	18,8	294,0	610,0
704690	4 x 1	18	8,7	56,0	110,0
704691	6 x 1	18	10,2	82,0	150,0
704692	8 x 1	18	11,7	106,0	210,0
704693	12 x 1	18	13,3	150,0	280,0
704694	2 x 2 x 1,5	16	12,1	90,0	180,0
704695	3 x 2 x 1,5	16	12,8	120,0	240,3
704696	4 x 2 x 1,5	16	14,6	150,0	210,0

Core identification black

Part no.	No.cores x cross-sec. mm ²	AWG-No.	Outer Ø app. mm	Cop. weight kg / km	Weight app. kg / km
703703	1 x 70	2/0	19,6	741,1	994,0
703704	1 x 95	3/0	22,3	993,0	1305,0
703705	1 x 120	4/0	24,7	1241,6	1603,0
703706	1 x 150	300 kcmil	25,3	1548,0	1924,1
703707	1 x 185	350 kcmil	29,8	1900,2	2415,0
703708	1 x 240	450 kcmil	30,7	2444,4	3030,0
703804	1 x 300	500 kcmil	33,4	3027,0	3785,7

Dimensions and specifications may be changed without prior notice.

HELUWIND® WK 137-Torsion FT4

0,6/1 kV, 90°C (80°C acc. to UL), suitable offshore, UV resistant,
UL/CSA-Style 10553/20234 Single-/Multicore



Technical data

- **Temperature range**
flexing -40°C to +90°C
fixed installation -40°C to +90°C
acc. to UL to +80°C
- Permissible conductor **operating temperature** +90°C
- **Nominal voltage**
VDE U₀/U 0,6/1 kV
UL 1000 V
- **Test voltage**
core/core 4000 V
- **Highest permissible voltage**
- DC:
Conductor/Conductor 1,8 kV
Conductor/Earth 0,9 kV
- AC: Conductor/Earth 0,7 kV
- Three phase: Conductor/Conductor 1,2 kV
- **Minimum bending radius**
flexing 8x cable Ø
fixed installation 4x cable Ø
- **Torsion application**
+/-150° per 1m
- **Approvals**
Singlecore UL Style 10553
Multicore UL Style 20234
cRUus
- **Flame test**
FT4, IEC 60332-3-24
UL 758, Cable flame test
- **Halogen-free**
IEC 60754-1
- **Smoke density**
IEC 61034-1+2
- **Oil**
acc. to oil res II
- **WTTC** in preparation

Cable structure

- Special bare copper conductor,
acc. to IEC 60228
- Insulation: special compound
- Core identification: see table
- Multiconductors cabled
- Sheath: special compound SSH
- Sheath colour: black

Properties

- Halogen-free
- Extremely abrasion resistant
- Low adhesion
- High flame retardant
- Torsion tested
- Suitable for offshore applications
- Extremely oil resistant
- UV resistant
- Multi-climate operation
- Designed for CCV application
- Easy to assemble

Note

For more information, especially on custom cables, please contact us: wind@helukabel.de

Application

The WK 137-Torsion FT4 has been designed for flexible use, and specifically for torsional load in the cable loop of a wind power plant. The voltage level has been configured as 0.6/1 kV for all dimensions, which means that the cables can also be laid in parallel in compliance with UL standards. It is no longer necessary to separate the cable routes. Additionally, this cable meets the strict requirements of CSA flame test FT4 and, thanks to its highly durable sheath and absence of halogen, is ideal for use in offshore wind power plants. The WK series has been successfully tested for more than 18,000 torsion cycles and thus offers optimum operational reliability far beyond the service life of the wind power plant. Advantages of WK 137-Torsion FT4 over H07BN4-F: Fire behaviour in accordance with IEC 60332-3-24 and FT4, increased wear resistance.

☑️ = Product conforms with Low-Voltage Directive 2014/35/EU.

Continuation ▶

HELUWIND® WK 137-Torsion FT4

0,6/1 kV, 90°C (80°C acc. to UL), suitable offshore, UV resistant,
UL/CSA-Style 10553/20234 Single-/Multicore



Core identification black with white numbers, 3 cores and more with GN-YE

Part no.	No.cores x cross-sec. mm ²	AWG-No.	Outer Ø app. mm	Cop. weight kg / km	Weight app. kg / km
705741	3 G 0,75	19	7,1	22,0	88,0
705742	5 G 0,75	19	8,6	36,0	122,0
705743	7 G 0,75	19	10,0	51,0	170,0
705744	12 G 0,75	19	11,8	87,0	220,0
705745	18 G 0,75	19	13,9	130,0	310,0
705719	3 G 1	18	7,8	49,0	133,0
705746	5 G 1	18	9,0	48,0	110,0
705747	7 G 1	18	10,5	68,0	140,0
705748	12 G 1	18	13,2	116,0	240,0
705749	18 G 1	18	15,1	173,0	360,0
705720	3 G 1,5	16	8,4	44,0	113,5
705721	4 G 1,5	16	9,1	58,0	139,8
705722	5 G 1,5	16	9,9	72,0	166,5
705723	7 G 1,5	16	11,5	101,0	235,2
705724	12 G 1,5	16	14,3	173,0	360,0
705725	18 G 1,5	16	16,8	260,0	524,6
705726	3 G 2,5	14	9,3	72,0	151,4
705727	5 G 2,5	14	11,1	120,0	227,6
705750	7 G 2,5	14	14,4	168,0	360,0
705751	3 G 4	12	10,8	116,0	222,0
705752	5 G 4	12	13,2	192,0	382,0
705753	7 G 4	12	15,9	269,0	530,0
705754	3 G 6	10	13,1	173,0	340,0
705728	4 G 6	10	14,6	231,0	460,0
705729	5 G 6	10	16,3	288,0	508,6
705755	7 G 6	10	19,6	404,0	780,0

Dimensions and specifications may be changed without prior notice.

Core identification black with white numbers, 3 cores and more with GN-YE

Part no.	No.cores x cross-sec. mm ²	AWG-No.	Outer Ø app. mm	Cop. weight kg / km	Weight app. kg / km
705730	4 G 10	8	17,4	384,0	670,0
705757	4 G 16	6	20,7	615,0	1000,0
705731	5 G 16	6	25,8	768,0	1390,0
705732	4 G 25	4	26,2	960,0	1556,6
705758	5 G 25	4	28,2	1200,0	1900,0
705759	4 G 35	2	31,0	1344,0	2234,6
705733	5 G 35	2	34,7	1680,0	2747,3
705756	5 G 10	8	20,9	480,0	893,6

Core identification black

Part no.	No.cores x cross-sec. mm ²	AWG-No.	Outer Ø app. mm	Cop. weight kg / km	Weight app. kg / km
708974	1 x 25	4	11,4	240,0	454,0
708975	1 x 35	2	13,4	336,0	476,0
708976	1 x 50	1	15,6	480,0	630,0
708977	1 x 70	2/0	18,2	672,0	894,0
708978	1 x 95	3/0	21,9	912,0	1222,0
708979	1 x 120	4/0	22,9	1152,0	1314,0
708980	1 x 150	300 kcmil	24,7	1440,0	1814,0
708981	1 x 185	350 kcmil	26,1	1776,0	2186,0
708982	1 x 240	450 kcmil	30,2	2304,0	2810,0
708983	1 x 300	500 kcmil	32,8	2880,0	3518,0
708984	1 x 400	750 kcmil	39,3	3840,0	4500,0

HELUWIND® WK 137 EMV D-Torsion

FT4

0,6/1 kV, 90°C (80°C acc. to UL), suitable offshore, screened,
UV resistant, UL/CSA-Style 10553/20234 Single-/Multicore



Technical data

- **Temperature range**
flexing -40°C to +90°C
fixed installation -40°C to +90°C
acc. to UL to +80°C
- Permissible conductor **operating temperature** +90°C
- **Nominal voltage**
VDE U₀/U 0,6/1 kV
UL 1000 V
- **Test voltage**
core/core 4000 V
core/screen 2000 V
- **Highest permissible voltage**
- DC:
Conductor/Conductor 1,8 kV
Conductor/Earth 0,9 kV
- AC: Conductor/Earth 0,7 kV
- Three phase: Conductor/Conductor 1,2 kV
- **Minimum bending radius**
flexing 10x cable Ø
fixed installation 5x cable Ø
- **Torsion application**
+/- 150° per 1m
- **Approvals**
Singlecore UL Style 10553
Multicore UL Style 20234
cRUus
- **Flame test**
FT4, IEC 60332-3-24
UL 758, Cable flame test
- **Halogen-free**
IEC 60754-1
- **Smoke density**
IEC 61034-1+2
- **Oil**
acc. to oil res II
- **WTTC** in preparation

Cable structure

- Special bare copper conductor,
acc. to IEC 60228
- Insulation: special compound
- Core identification: see table
- Multiconductors cabled
- EMC-screened types have tinned
copper wrapping
- Sheath: special compound SSH
- Sheath colour: black

Properties

- Halogen-free
- Extremely abrasion resistant
- Low adhesion
- High flame retardant
- Torsion tested
- Suitable for offshore applications
- Extremely oil resistant
- UV resistant
- Multi-climate operation
- Designed for CCV application
- Easy to assemble

Note

For more information, especially on
custom cables, please contact us:
wind@helukabel.de

Application

The WK 137 EMV D-Torsion FT4 has been designed for flexible use, and specifically for torsional load in the cable loop of a wind power plant. The voltage level has been configured as 0.6/1 kV for all dimensions, which means that the cables can also be laid in parallel in compliance with UL standards. It is no longer necessary to separate the cable routes. Additionally, this cable meets the strict requirements of CSA flame test FT4 and, thanks to its highly durable sheath and absence of halogen, is ideal for use in offshore wind power plants. The WK series has been successfully tested for more than 18,000 torsion cycles and thus offers optimum operational reliability far beyond the service life of the wind power plant. Advantages of WK 137-Torsion over H07BN4-F: Fire behaviour in accordance with IEC 60332-3-24 and FT4, increased wear resistance.

EMC = Electromagnetic compatibility

To optimize the EMC features we recommend a large round contact of the copper wrapping on both ends.

CE = Product conforms with Low-Voltage Directive 2014/35/EU.

Continuation ▶

HELUWIND® WK 137 EMV D-Torsion

FT4

0,6/1 kV, 90°C (80°C acc. to UL), suitable offshore, screened,
UV resistant, UL/CSA-Style 10553/20234 Single-/Multicore



**Core identification black with white numbers,
3 cores and more with GN-YE**

Part no.	No. cores x cross-sec. mm ²	AWG-No.	Outer Ø app. mm	Cop. weight kg / km	Weight app. kg / km
706461	4 G 0,34	22	7,7	32,0	91,0
706462	4 G 0,5	20	8,0	37,8	105,0
706463	6 G 0,5	20	9,2	53,6	130,0
706464	4 x 2 x 0,5	20	11,5	69,2	190,0
706465	10 G 0,5	20	11,4	73,0	170,0
706466	12 G 0,5	20	11,7	88,4	220,0
706467	3 G 0,75	19	7,1	43,2	97,0
706468	4 G 0,75	19	7,8	52,6	122,0
706469	5 G 0,75	19	9,0	63,0	145,0
706470	7 G 0,75	19	10,2	82,8	200,0
706471	4 x 2 x 0,75	19	12,7	91,0	220,0
706472	8 G 0,75	19	10,7	93,0	220,0
706473	12 G 0,75	19	12,2	126,9	257,5
706474	18 G 0,75	19	14,5	179,0	400,0
706475	12 x 2 x 0,75	19	17,6	223,0	520,0
706476	25 G 0,75	19	17,3	238,3	544,0
706477	41 G 0,75	19	21,2	370,8	795,0
706478	50 G 0,75	19	23,5	441,0	900,0
706479	2 x 1,5	16	6,8	44,0	86,0
706480	3 G 1,5	16	8,8	68,0	133,0
706481	4 G 1,5	16	9,4	87,8	159,0
706482	5 G 1,5	16	10,3	104,4	195,0
706483	7 G 1,5	16	11,9	140,8	247,0
706484	12 G 1,5	16	14,7	226,8	410,0
706485	3 G 2,5	14	9,8	104,4	210,0
706486	4 G 2,5	14	10,5	132,7	264,0
706488	7 G 2,5	14	13,5	223,1	411,0
706487	12 G 2,5	14	12,3	161,0	288,0
706489	12 G 2,5	14	16,7	350,6	560,0
706490	19 G 2,5	14	21,7	561,0	638,0
706491	5 G 4	12	13,6	237,4	382,0
706492	7 G 4	12	16,3	325,0	582,0
706493	12 G 4	12	20,0	532,1	806,0
706494	3 G 6	10	12,9	203,3	436,0
706495	5 G 6	10	17,4	341,0	640,0
706496	4 G 10	8	17,8	445,6	727,0
706497	5 G 10	8	21,8	550,2	935,0
706498	4 G 16	6	23,6	696,5	1176,0
706499	5 G 16	6	26,2	885,0	1428,0
706500	4 G 25	4	26,9	1059,4	1742,0
706501	5 G 25	4	30,1	1327,4	2108,0

Core identification acc. to DIN 47100

Part no.	No. cores x cross-sec. mm ²	AWG-No.	Outer Ø app. mm	Cop. weight kg / km	Weight app. kg / km
706510	2 x 2 x 0,25	24	8,9	27,0	90,0
706511	4 x 2 x 0,25	24	9,9	39,0	115,0
706512	5 x 2 x 0,25	24	11,1	46,0	130,0
706513	2 x 2 x 0,34	22	9,6	35,0	110,0
706514	4 x 2 x 0,34	22	11,0	47,0	130,0
706515	2 x 2 x 0,5	20	9,8	39,0	115,0
706516	4 x 0,5	20	8,0	37,8	105,0
706517	6 x 0,5	20	9,2	53,6	130,0
706518	4 x 2 x 0,5	20	11,3	69,5	150,0
706519	2 x 2 x 0,75	19	10,4	54,0	130,0
706520	4 x 2 x 0,75	19	12,7	91,0	220,0
706521	12 x 0,75	19	12,2	126,9	257,5
706522	8 x 2 x 0,75	19	17,1	170,0	410,0
706523	12 x 2 x 0,75	19	17,6	223,0	520,0
706524	32 x 0,75	19	18,8	294,0	610,0
706525	4 x 1	18	8,7	56,0	110,0
706526	6 x 1	18	10,2	82,0	150,0
706527	8 x 1	18	11,7	106,0	210,0
706528	12 x 1	18	13,3	150,0	280,0
706529	2 x 2 x 1,5	16	12,1	90,0	180,0
706530	3 x 2 x 1,5	16	14,0	120,0	235,0

Core identification black

Part no.	No. cores x cross-sec. mm ²	AWG-No.	Outer Ø app. mm	Cop. weight kg / km	Weight app. kg / km
706503	1 x 70	2/0	19,6	741,1	994,0
706504	1 x 95	3/0	22,3	993,0	1305,0
706505	1 x 120	4/0	24,7	1241,6	1603,0
706506	1 x 150	300 kcmil	25,3	1548,0	1970,0
706507	1 x 185	350 kcmil	29,8	1900,2	2415,0
706508	1 x 240	450 kcmil	32,7	2444,4	3030,0
706509	1 x 300	500 kcmil	34,0	3300,0	4310,0

Dimensions and specifications may be changed without prior notice.

HELUWIND® WK 101 H

0,6/1 kV, halogen free, high flexible



Technical data

- **Temperature range**
flexing -40°C to +90°C
fixed installation -50°C to +100°C
- Permissible conductor **operating temperature** +90°C
- **Nominal voltage**
VDE U₀/U 0,6/1 kV
- **Test voltage**
4000 V
- **Highest permissible voltage**
- DC:
Conductor/Conductor 1,8 kV
Conductor/Earth 0,9 kV
- AC: Conductor/Earth 0,7 kV
- Three phase: Conductor/Conductor 1,2 kV
- **Minimum bending radius**
flexing 7,5x cable Ø
fixed installation 4x cable Ø
- **Halogen-free**
IEC 60754-1

Cable structure

- Special bare copper conductor, fine stranded acc. to IEC 60228
- Separating foil wrap
- Insulation: special compound black
- Sheath: special compound
- Sheath colour: black

Properties

- Halogen-free
- Abrasion resistant
- Extremely oil resistant
- UV and ozone-resistant
- Recyclable
- Multi-climate application

Note

A torsional version for loop application is available on request.

For more information, especially on custom cables, please contact us: wind@helukabel.de

Application

The HELUWIND® WK series has been specifically designed for use in wind power plants. These cables are used in cases that require extremely narrow bending radii and high current carrying capacity levels (+90°C conductor temperature).

☑ = Product conforms with Low-Voltage Directive 2014/35/EU.

Part no.	No. cores x cross-sec. mm ²	AWG-No.	Outer Ø app. mm	Cop. weight kg / km	Weight app. kg / km
707522	1 x 16	-	9,7	154,0	240,0
707523	1 x 25	-	11,2	240,0	287,7
707524	1 x 35	-	12,6	336,0	394,4
707525	1 x 50	-	14,2	480,0	590,0
707526	1 x 70	-	16,2	672,0	757,7
707527	1 x 95	-	18,9	912,0	1230,0

Part no.	No. cores x cross-sec. mm ²	AWG-No.	Outer Ø app. mm	Cop. weight kg / km	Weight app. kg / km
707528	1 x 120	-	20,2	1152,0	1295,7
707529	1 x 150	-	22,8	1440,0	1679,7
707494	1 x 185	-	26,7	1776,0	2009,9
707495	1 x 240	-	30,5	2304,0	2900,0
707530	1 x 300	-	34,9	2880,0	3490,1
707531	1 x 400	-	40,1	3840,0	4430,0

Dimensions and specifications may be changed without prior notice.

HELUWIND® WK 110-Torsion

0,6/1 kV, UV resistant, halogen-free



Technical data

- **Temperature range**
flexing -40°C to +90°C
fixed installation -40°C to +90°C
- **Permissible conductor operating temperature** +90°C
- **Nominal voltage**
VDE U₀/U 0,6/1 kV
- **Test voltage**
core/core 4000 V
- **Highest permissible voltage**
- DC:
Conductor/Conductor 1,8 kV
Conductor/Earth 0,9 kV
- AC: Conductor/Earth 0,7 kV
- Three phase: Conductor/Conductor 1,2 kV
- **Minimum bending radius**
flexing 6x cable Ø
fixed installation 4x cable Ø
- **Torsion application**
+/- 150° per 1m
- **Flame test**
IEC 60332-1-2
- **Corrosiveness of combustion gases**
IEC 60754-2
- **Halogen-free**
IEC 60754-1
- **Smoke density**
IEC 61034-2
- **Oil**
IEC 60811-2-1,
acc. to IEC 60811-404

Cable structure

- Special bare copper conductors, fine stranded acc. to IEC 60228
- Insulation: special compound
- Core identification: see table
- Sheath: special compound
- Sheath colour: black

Properties

- Halogen-free
- Extremely abrasion resistant
- Flame retardant
- Torsion tested
- Extremely oil resistant
- UV resistant
- Ozon-resistant
- Multi-climate operation
- Designed for CCV application
- Easy to assemble

Note

For more information, especially on custom cables, please contact us: wind@helukabel.de

Application

The WK 110-Torsion has been designed for flexible use, and specifically for torsional load in the cable loop of a wind power plant. The voltage level has been configured as 0.6/1 kV for all dimensions. The WK series has been successfully tested for more than 18,000 torsion cycles and thus offers optimum operational reliability far beyond the service life of the wind power plant.

☑ = Product conforms with Low-Voltage Directive 2014/35/EU.

Core identification acc. to DIN VDE 0293-308

Part no.	No. cores x cross-sec. mm²	AWG-No.	Outer Ø app. mm	Cop. weight kg / km	Weight app. kg / km
710751	3 G 1,5	-	8,4	43,2	111,9
710571	4 G 1,5	-	8,9	58,0	126,9
710752	5 G 1,5	-	9,9	72,0	154,6
710759	3 G 2,5	-	9,3	72,0	151,4
710760	4 G 2,5	-	10,1	96,0	181,4

Core identification black

Part no.	No. cores x cross-sec. mm²	AWG-No.	Outer Ø app. mm	Cop. weight kg / km	Weight app. kg / km
710435	1 x 1,5	-	3,9	14,4	27,0
710436	1 x 2,5	-	4,6	24,0	37,0
710437	1 x 4	-	5,5	38,4	52,0
710438	1 x 6	-	6,5	57,6	76,0

Core identification black

Part no.	No. cores x cross-sec. mm²	AWG-No.	Outer Ø app. mm	Cop. weight kg / km	Weight app. kg / km
709855	1 x 10	-	8,3	96,0	158,0
709856	1 x 16	-	10,7	153,6	268,0
709857	1 x 25	-	11,8	240,0	381,0
709858	1 x 35	-	13,3	336,0	454,0
709859	1 x 50	-	15,8	480,0	625,0
709860	1 x 70	-	18,4	672,0	894,1
709861	1 x 95	-	20,4	912,0	1222,0
709862	1 x 120	-	22,9	1152,0	1490,0
709863	1 x 150	-	25,5	1440,0	1910,0
709864	1 x 185	-	27,8	1776,0	2310,0
709865	1 x 240	-	30,5	2304,0	2980,0
709866	1 x 300	-	33,5	2880,0	3600,0
709867	1 x 400	-	37,5	3840,0	4500,0

Dimensions and specifications may be changed without prior notice.

HELUWIND® WK H07BN4-F WIND-Torsion

750 V, +90°C, UV resistant



Technical data

- **Temperature range**
Ambient temperature -45°C to +90°C
- Permissible conductor **operating temperature** +90°C
- **Nominal voltage**
450/750 V
- **Test voltage**
3000 V
- **Minimum bending radius**
6x cable Ø
- **Torsion application**
+/- 150° per 1m

Cable structure

- Special bare copper conductor, fine stranded acc. to IEC 60228
- Insulation: special EPR compound
- Core identification: black
- Sheath: special EPR compound
- Sheath colour: black

Properties

- UV resistant

Note

For more information, especially on custom cables, please contact us: wind@helukabel.de

Application

The HELUWIND® WK H07BN4-F Wind-Torsion cable is the special version for torsion applications in wind power plants. We supply the leading wind power plant manufacturers with our cables.

CE = Product conforms with Low-Voltage Directive 2014/35/EU.

Part no.	No. cores x cross-sec. mm ²	AWG-No.	Outer Ø app. mm	Cop. weight kg / km	Weight app. kg / km
703402	1 x 25	-	13,1	240,0	516,0
703403	1 x 35	-	14,6	336,0	670,0
703404	1 x 50	-	17,1	480,0	840,0
703390	1 x 70	-	19,2	672,0	1112,0
703391	1 x 95	-	22,0	912,0	1520,0
703392	1 x 120	-	24,4	1152,0	1880,0
703393	1 x 150	-	28,0	1440,0	2513,0

Part no.	No. cores x cross-sec. mm ²	AWG-No.	Outer Ø app. mm	Cop. weight kg / km	Weight app. kg / km
703394	1 x 185	-	30,0	1776,0	2272,0
703395	1 x 240	-	34,0	2304,0	3534,0
703396	1 x 300	-	36,1	2880,0	4020,0
703398	1 x 500	-	46,0	4800,0	6000,0
703399	1 x 630	-	54,0	6048,0	6900,0
703397	1 x 400	-	41,5	3840,0	5640,0

Dimensions and specifications may be changed without prior notice.

HELUWIND® WK Brandmeldekabel-Torsion

halogen-free, FT1



Technical data

- **Temperature range**
flexing -40°C to +80°C
fixed installation -50°C to +90°C
- **Nominal voltage**
U₀/U 300/500 V
- **Test voltage**
core/core 1500 V
core/screen 800 V
- **Minimum bending radius**
10x cable Ø
- **Torsion application**
3 x 360° on 5m (= 216° per m)
- **Flame test**
IEC 60332-1-2,
acc. to DIN VDE 0472 part 804
test method B

Cable structure

- Special bare copper conductor, extra fine stranded acc. to IEC 60228 cl.6
- Special Polyester insulation
- Core identification: black cores with continuous white numbering
- Multiconductors cabled
- EMC-screened types have tinned copper wrapping
- Sheath: special polyurethane compound low adhesion
- Sheath colour: red (RAL 3000)

Properties

- Very good oil and petrol resistance acc. to DIN VDE 0250 and 0472
- Good resistance to acids, alkalis and solvents
- UV resistant

Note

For more information, especially on custom cables, please contact us: wind@helukabel.de

Application

This fire alarm cable has been specifically developed for torsion applications in wind power plant loops. We supply the leading wind power plant manufacturers with our cables.

CE = Product conforms with Low-Voltage Directive 2014/35/EU.

Part no.	No. cores x cross-sec. mm ²	AWG-No.	Outer Ø app. mm	Cop. weight kg / km	Weight app. kg / km
702485	4 x 0,75	-	6,6	49,0	82,0

Dimensions and specifications may be changed without prior notice.

HELUWIND® WK DLO, WK DLO-Torsion

2 kV, FT4, VW-1, RHH/RHW-2, UL44



Technical data

- **Temperature range**
flexing -40°C to +90°C
- **Nominal voltage**
2000 V
- **Torsion application**
only for WK DLO-Torsion
+/- 150° per 1m
- **Torsion rating**
Torsion tested in accordance with
HELUKABEL test requirements
- **Approvals**
RHH/RHW-2, PRI PRII, CSA RW90,
CSA 22.2 No. 38, VW-1,
cold impact test, cold bend test,
wet or dry per UL44, for CT use
- **Flame test**
CSA FT1, FT4, IEEE 1202

Cable structure

- Special stranded bare copper wire,
fine stranded acc. to ASTM-B3
- Insulation: EP
- Separating foil wrap
- Sheath: TPE/CPE
- Sheath colour: black

Properties

- UV resistant

Note

For more information, especially on
custom cables, please contact us:
wind@helukabel.de

Application

The cable HELUWIND® WK DLO was specifically designed for use in wind turbines up to a nominal voltage of 2 kV. It has been specially developed for torsion applications in wind turbines. We supply the leading wind turbine manufacturers.

WK DLO 2 kV

Part no.	Cross-section AWG / kcmil	Outer Ø app. mm	Weight app. kg / km	Outer Ø app. inch	Weight app. lb / kft
703156	14	5,9	37,0	0,23	0,0
703157	12	6,3	69,0	0,25	0,0
703158	10	7,2	100,0	0,28	0,0
702513	8	8,4	142,0	0,33	0,0
703159	6	9,4	200,0	0,37	0,0
703160	4	11,2	286,0	0,44	0,0
703161	2	12,7	370,0	0,50	0,0
703162	1	16,4	637,0	0,65	0,0
703163	1/0	16,7	715,0	0,66	0,0
703862	2/0	17,6	830,0	0,69	0,0
703164	3/0	19,6	1104,0	0,77	0,0
702863	4/0	21,0	1298,0	0,83	0,0
702514	262 kcmil	23,7	1590,0	0,93	0,0
703165	313 kcmil	25,4	1872,0	1,00	0,0
708857	373 kcmil	27,1	2176,0	1,07	0,0
703167	444 kcmil	28,8	2570,0	1,13	0,0
702515	535 kcmil	31,4	3046,0	1,24	0,0
703168	646 kcmil	33,6	3600,0	1,32	0,0
703169	777 kcmil	36,0	4290,0	1,42	0,0
703170	929 kcmil	38,4	5144,0	1,51	0,0
703171	1111 kcmil	42,5	6070,0	1,67	0,0

WK DLO-Torsion 2 kV

Part no.	Cross-section AWG / kcmil	Outer Ø app. mm	Weight app. kg / km	Outer Ø app. inch	Weight app. lb / kft
709729	8	8,4	142,0	0,33	0,0
709730	6	9,4	200,0	0,37	0,0
709731	4	11,2	286,0	0,44	0,0
709732	2	12,7	370,0	0,50	0,0
709733	1	16,4	637,0	0,65	0,0
709734	1/0	16,7	715,0	0,66	0,0
709735	2/0	17,6	830,0	0,69	0,0
709288	3/0	19,6	1104,0	0,77	0,0
709289	4/0	21,0	1298,0	0,83	0,0
709290	262 kcmil	23,7	1590,0	0,93	0,0
709291	313 kcmil	25,4	1872,0	1,00	0,0
709292	373 kcmil	27,1	2176,0	1,07	0,0
709293	444 kcmil	28,8	2570,0	1,13	0,0
709294	535 kcmil	31,4	3046,0	1,24	0,0
709295	646 kcmil	33,6	3600,0	1,32	0,0
709296	777 kcmil	36,0	4290,0	1,42	0,0
709297	929 kcmil	38,4	5144,0	1,51	0,0
709298	1111 kcmil	42,5	6070,0	1,67	0,0

Dimensions and specifications may be changed without prior notice.

HELUWIND® WK 300w-Torsion

1,8/3 kV, UV resistant, direct burial



Technical data

- **Temperatur range**
flexing -35°C to +90°C
fixed installation -40°C to +90°C
installation -20°C to +90°C
- Permissible conductor **operating temperature** +90°C
- **Nominal voltage**
VDE U₀/U 1,8/3 kV
- **Test voltage**
9000 V
- **Minimum bending radius**
flexing 10x cable Ø
fixed installation 5x cable Ø
- **Torsion application**
for unscreened version
+/- 100° per 1m
- **Flame test**
self-extinguishing and flame retardant
acc. to IEC 60332-1-2

Cable structure

- Special bare copper conductor, fine stranded acc. to IEC 60228
- Special heat-resistant insulation black
- Sheath: special heat-resistant compound
- Sheath colour: black

Properties

- UV resistant
- Multi-climate operation
- Torsion tested
- Flame retardant
- Oil resistant
- Recyclable
- Easy to assemble
- Also for direct burial

Note

For more information, especially on custom cables, please contact us: wind@helukabel.de

Application

The WK 300w-Torsion has been designed for flexible use, and specifically for torsional load in the cable loop of a wind power plant. The WK series has been successfully tested for more than 18,000 torsion cycles and thus offers optimum operational reliability far beyond the service life of the wind power plant. Another special feature is the higher voltage level of 1.8/3 kV. The WK 300w-Torsion is also designed for flexible installation through ductwork and in the ground. It can be used in power cabling from a converter cabinet to an external transformer station, for example. A conductor temperature of +90° enables a high level of current carrying capacity.

Part no.	No. cores x cross-sec. mm ²	AWG-No.	Outer Ø app. mm	Cop. weight kg / km	Weight app. kg / km	Part no.	No. cores x cross-sec. mm ²	AWG-No.	Outer Ø app. mm	Cop. weight kg / km	Weight app. kg / km
706432	1 x 35	-	14,8	336,0	500,0	706403	1 x 150	-	25,9	1440,0	1990,0
706399	1 x 50	-	16,6	480,0	660,0	706404	1 x 185	-	28,1	1776,0	2430,0
712574	1 x 70	-	19,5	672,0	920,0	706405	1 x 240	-	31,2	2304,0	2877,9
706401	1 x 95	-	23,9	912,0	1300,0	706406	1 x 300	-	34,2	2880,0	3960,0
706402	1 x 120	-	24,8	1152,0	1600,0	706407	1 x 400	-	39,2	3840,0	4800,0

Dimensions and specifications may be changed without prior notice.

HELUWIND® WK 310-Torsion

1,8/3 kV, UV resistant



Technical data

- **Temperature range**
flexing -40°C to +90°C
fixed installation -40°C to +90°C
- **Permissible conductor operating temperature** +90°C
- **Nominal voltage**
VDE U₀/U 1,8/3 kV
- **Test voltage**
9000 V
- **Minimum bending radius**
flexing 10x cable Ø
fixed installation 5x cable Ø
- **Torsion application**
+/- 150° per 1m
- **Flame test**
IEC 60332-3
- **Halogen-free**
IEC 60754-1
- **Smoke density**
IEC 61034-1+2
- **Oil test**
acc. to oil res II

Cable structure

- Special bare copper conductor, fine stranded acc. to IEC 60228
- Special insulation black
- Sheath: compound low adhesion
- Sheath colour: black

Properties

- Halogen-free
- Extremely abrasion resistant
- Low adhesion
- High flame retardant
- Torsion tested
- Extremely oil resistant
- UV resistant
- Recyclable
- Multi-climate operation
- Designed for CCV application
- Easy to assemble

Note

For more information, especially on custom cables, please contact us: wind@helukabel.de

Application

The WK 310-Torsion has been designed for flexible use, and specifically for torsional load in the cable loop of a wind power plant. The WK series has been successfully tested for more than 18,000 torsion cycles and thus offers optimum operational reliability far beyond the service life of the wind power plant. Another special feature is the higher voltage level of 1.8/3 kV. The WK 310-Torsion can be used instead of the WK 305.

Part no.	No. cores x cross-sec. mm ²	AWG-No.	Outer Ø app. mm	Cop. weight kg / km	Weight app. kg / km
706452	1 x 50	-	15,0	480,0	660,0
706453	1 x 70	-	20,0	672,0	920,0
706454	1 x 95	-	23,8	912,0	1300,0
706455	1 x 120	-	26,3	1152,0	1600,0
706456	1 x 150	-	29,2	1440,0	1990,0

Part no.	No. cores x cross-sec. mm ²	AWG-No.	Outer Ø app. mm	Cop. weight kg / km	Weight app. kg / km
706457	1 x 185	-	28,6	1776,0	2310,0
706458	1 x 240	-	30,5	2304,0	2800,0
706459	1 x 300	-	34,9	2880,0	3600,0
706460	1 x 400	-	39,8	3840,0	4840,0

Dimensions and specifications may be changed without prior notice.

HELUWIND® WK MS Single 610-Torsion

3,6/6 kV



Technical data

- **Temperatur range**
flexing -40°C to +90°C
- **Nominal voltage**
3,6/6 kV
- **Minimum bending radius**
12x cable Ø
- **Torsion application**
+/- 105° per 1m

Cable structure

- Special bare copper conductor, fine stranded acc. to IEC 60228
- Special semiconductor layer
- Special insulation black
- Copper screen
- Sheath: special rubber compound
- Sheath colour: black

Properties

- Abrasion resistant
- Flame retardant
- Torsion tested
- Oil resistant
- UV resistant
- Multi-climate operation
- Designed for CCV application
- Easy to assemble

Note

For more information, especially on custom cables, please contact us: wind@helukabel.de

Application

The WK MS Single 610-Torsion is designed for flexible applications, especially to accommodate torsional stress in the cable loop of a wind turbine. The HELUKABEL WK series was successfully tested for over 18,000 torsion cycles and offers operational reliability well beyond the service life of a wind turbine. Voltage levels: 3.6/6 kV.

Part no.	No. cores x cross-sec. mm ²	AWG-No.	Outer Ø app. mm	Cop. weight kg / km	Weight app. kg / km
712575	1 x 185	-	30,1	1776,0	2512,0
712576	1 x 240	-	34,2	2304,0	3083,0
712577	1 x 300	-	37,2	2880,0	4020,0

Dimensions and specifications may be changed without prior notice.

HELUWIND® WK MS Single-Torsion

12/20 kV



Technical data

- **Temperatur range**
flexing -40°C to +90°C
- **Nominal voltage**
12/20 kV
- **Minimum bending radius**
12x cable Ø
- **Torsion application**
+/- 105° per 1m

Cable structure

- Special bare copper conductor, fine stranded acc. to IEC 60228
- Special semiconductor layer
- Special insulation black
- Sheath: special rubber compound
- Sheath colour: black

Properties

- Abrasion resistant
- Flame retardant
- Torsion tested
- Oil resistant
- UV resistant
- Multi-climate operation
- Designed for CCV application
- Easy to assemble

Note

For more information, especially on custom cables, please contact us: wind@helukabel.de

Application

The WK MS Single-Torsion is designed for flexible applications, especially to accommodate torsional stress in the cable loop of a wind turbine. Due to its flexible structure, the cable allows for small bending radii and is ideally suited for power wiring in wind turbines. Voltage level: 12/20 kV.

12/20kV

Part no.	No. cores x cross-sec. mm ²	AWG-No.	Outer Ø app. mm	Cop. weight kg / km	Weight app. kg / km
708712	1 x 120	-	27,3	1152,0	1860,0
708713	1 x 150	-	29,5	1440,0	2090,0
708714	1 x 185	-	31,6	1776,0	2530,0
708715	1 x 240	-	34,7	2304,0	3420,0
708716	1 x 300	-	36,8	2880,0	4100,0

Dimensions and specifications may be changed without prior notice.

HELUWIND® WK MS Single-Torsion UL/CSA

3,6/6 kV, 12/20 kV



Technical data

- **Temperatur range**
flexing -40°C to +90°C
- **Nominal voltage**
3,6/6 kV or
12/20 kV
- **Minimum bending radius**
12x cable Ø
- **Torsion application**
+/- 105° per 1m
- **Approvals**
UL 1072

Cable structure

- Special bare copper conductor, fine stranded acc. to IEC 60228
- Special semiconductor layer
- Special insulation black
- Copper screen
- Sheath: special rubber compound
- Sheath colour: black

Properties

- Abrasion resistant
- Flame retardant
- Torsion tested
- Oil resistant
- UV resistant
- Multi-climate operation
- Designed for CCV application
- Easy to assemble

Note

For more information, especially on custom cables, please contact us: wind@helukabel.de

Application

The WK MS Single-Torsion UL/CSA has been designed for flexible use, and specifically for torsional load in the cable loop of a wind power plant in the voltage levels 3.6/6 kV and 12/20 kV. According to the UL standard, the WK MS-Single-Torsion UL/CSA carrying 2 kV and more is only available as a screened cable. Due to its flexible design, this cable is ideal for tight bending radii used in power cabling of wind turbines. Compared to the WK MS-Single, the cable holds an UL/CSA approval. Copper stranding per AWG/kcmil.

3,6/6kV

Part no.	No. cores x cross-sec. mm ²	AWG-No.	Outer Ø app. mm	Cop. weight kg / km	Weight app. kg / km
708702		262 kcmil	24,1	1280,0	1790,0
708703		313 kcmil	25,5	1590,0	2072,0
708704		373 kcmil	27,8	1900,0	2376,0
708705		444 kcmil	29,9	2272,0	2770,0
708706		535 kcmil	32,7	2608,0	3246,0
708707		646 kcmil	35,1	3300,0	3801,0
708708		777 kcmil	37,3	3970,0	4492,0
708709		929 kcmil	40,1	4780,0	5344,0
708710		1111 kcmil	44,2	5690,0	6410,0

12/20kV

Part no.	No. cores x cross-sec. mm ²	AWG-No.	Outer Ø app. mm	Cop. weight kg / km	Weight app. kg / km
708717		262 kcmil	26,1	1280,0	1990,0
708718		313 kcmil	27,2	1590,0	2191,0
708719		373 kcmil	29,8	1900,0	2563,0
708720		444 kcmil	31,9	2272,0	2983,0
708721		535 kcmil	34,9	2608,0	3471,0
708722		646 kcmil	37,2	3300,0	4020,0
708723		777 kcmil	39,4	3970,0	4696,0
708724		929 kcmil	42,4	4780,0	5552,0
708725		1111 kcmil	46,5	5690,0	6620,0

Dimensions and specifications may be changed without prior notice.

HELUWIND® WK MS Multi-Torsion

3,6/6 kV, 12/20 kV, 24/38 kV



Technical data

- **Temperatur range**
flexing -40°C to +90°C
- **Nominal voltage**
3,6/6 kV
12/20 kV
or 24/38 kV
- **Minimum bending radius**
12x cable Ø
- **Torsion application**
+/- 105° per 1m

Cable structure

- Special bare copper conductor, fine stranded acc. to IEC 60228
- Special semiconductor layer
- Special insulation black
- Core insulation with semiconductor layer for N-conductor
- Cores wrapped
- Inner Sheath special compound
- Sheath: special rubber compound
- Sheath colour: red

Properties

- Global application
- Abrasion resistant
- Flame retardant
- Torsion tested
- Oil resistant
- UV resistant
- Multi-climate operation
- Designed for CCV application
- Easy to assemble

Note

For more information, especially on custom cables, please contact us: wind@helukabel.de

Application

The WK MS Multi-Torsion is designed for flexible applications, especially to accommodate torsional stress in the cable loop of a wind turbine. Due to its flexible structure, the cable allows for small bending radii and is ideally suited for power wiring in wind turbines. Voltage levels: 3.6/6 kV, 12/20 kV, 24/38 kV.

3,6/6kV

Part no.	No. cores x cross-sec. mm ²	AWG-No.	Outer Ø app. mm	Cop. weight kg / km	Weight app. kg / km
708425	3 x 25 + 25	-	40,1	960,0	2600,0
708426	3 x 35 + 35	-	45,1	1344,0	3020,0
708427	3 x 50 + 50	-	47,2	1920,0	3500,0
708428	3 x 70 + 70	-	51,9	2688,0	4210,0

12/20kV

Part no.	No. cores x cross-sec. mm ²	AWG-No.	Outer Ø app. mm	Cop. weight kg / km	Weight app. kg / km
708726	3 x 25 + 25	-	41,9	960,0	2790,0
708727	3 x 35 + 35	-	47,0	1344,0	3231,0

12/20kV

Part no.	No. cores x cross-sec. mm ²	AWG-No.	Outer Ø app. mm	Cop. weight kg / km	Weight app. kg / km
708728	3 x 50 + 50	-	49,3	1920,0	3711,0
708729	3 x 70 + 70	-	54,0	2688,0	4421,0

24/38kV

Part no.	No. cores x cross-sec. mm ²	AWG-No.	Outer Ø app. mm	Cop. weight kg / km	Weight app. kg / km
708730	3 x 25 + 25	-	43,6	960,0	2910,0
708731	3 x 35 + 35	-	48,9	1344,0	3400,0
708732	3 x 50 + 50	-	51,2	1920,0	3921,0
708733	3 x 70 + 70	-	56,0	2688,0	4638,0

Dimensions and specifications may be changed without prior notice.

HELUWIND® WK MS Multi-Torsion UL/CSA

3,6/6 kV, 12/20 kV, 24/38 kV



Technical data

- **Temperatur range**
flexing -40°C to +90°C
- **Nominal voltage**
3,6/6 kV
12/20 kV
or 24/38 kV
- **Minimum bending radius**
12x cable Ø
- **Torsion application**
+/- 105° per 1m
- **Approvals**
UL 1072

Cable structure

- Special bare copper conductor, fine stranded acc. to IEC 60228
- Special semiconductor layer
- Special insulation EOR or AVGM
- Core insulation with semiconductor layer for N-conductor
- Cores wrapping
- Tinned copper screen
- Inner sheath: special compound
- Sheath: special halogen-free compound
- Sheath colour: black

Properties

- Global application
- Abrasion resistant
- Flame retardant
- Torsion tested
- Suitable for offshore applications
- Oil resistant
- UV resistant
- Multi-climate operation
- Designed for CCV application
- Easy to assemble

Note

For more information, especially on custom cables, please contact us: wind@helukabel.de

Application

The WK MS Multi-Torsion UL/CSA has been designed for flexible use, and specifically for torsional load in the cable loop of a wind turbine in the voltage levels 3.6/6 kV, 12/20 kV and 24/38 kV. Due to its flexible design, this cable is ideal for tight bending radii used in power cabling of wind turbines. Compared to the WK MS-Multi-Torsion, the cable holds an UL/CSA approval.

3,6/6kV

Part no.	No. cores x cross-sec. mm ²	AWG-No.	Outer Ø app. mm	Cop. weight kg / km	Weight app. kg / km
708734	3x4+4	40,1	960,0	2600,0	
708735	3x2+2	45,1	1344,0	3020,0	
708736	3x1+1	47,2	1920,0	3500,0	
708737	3x2/0+2/0	51,9	2688,0	4210,0	

12/20kV

Part no.	No. cores x cross-sec. mm ²	AWG-No.	Outer Ø app. mm	Cop. weight kg / km	Weight app. kg / km
708738	3x4+4	41,9	960,0	2790,0	
708739	3x2+2	47,0	1344,0	3231,0	

12/20kV

Part no.	No. cores x cross-sec. mm ²	AWG-No.	Outer Ø app. mm	Cop. weight kg / km	Weight app. kg / km
708740	3x1+1	49,3	1920,0	3711,0	
708741	3x2/0+2/0	54,0	2688,0	4421,0	

24/38kV

Part no.	No. cores x cross-sec. mm ²	AWG-No.	Outer Ø app. mm	Cop. weight kg / km	Weight app. kg / km
708742	3x4+4	43,6	960,0	2910,0	
708743	3x2+2	48,9	1344,0	3400,0	
708744	3x1+1	51,2	1920,0	3921,0	
708745	3x2/0+2/0	56,0	2688,0	4638,0	

Dimensions and specifications may be changed without prior notice.

HELUVIND® WK THERMFLEX 145

N2XH

Single 600-J/-O

Single 600-CY -J/-O



■ COPPER POWER CABLES

Designation	Page
HELWIND® WK THERMFLEX® 145	60
N2XH	61
Single 600-J/-O	63
Single 600-CY-J/-O	64

HELUWIND® WK THERMFLEX® 145

UV resistant, halogen-free, +145°C



Technical data

- **Temperature range**
flexing -20°C to +120°C
fixed installation -55°C to +145°C
- **Nominal voltage**
U₀/U 0,6/1 kV
- **Test voltage**
4000 V
- **Highest permissible voltage**
- DC:
Conductor/Conductor 1,8 kV
Conductor/Earth 0,9 kV
- AC: Conductor/Earth 0,7 kV
- Three phase: Conductor/Conductor 1,2 kV
- **Insulation resistance**
min. 100 MOhm x km
- **Minimum bending radius**
flexing 12,5x cable Ø
fixed installation 4x cable Ø
- **Flame test**
IEC 60332-3-24 Cat.C

Cable structure

- Tinned copper conductor,
fine stranded acc. to IEC 60228 cl.5
- Insulation: special polyolefin-copolymer,
halogen-free, flame retardant
- Sheath colour: black

Properties

- Halogen-free, no release
of corrosive or toxic gases
- Reduced propagation of fire
- Minimal smoke generation
- Good abrasion resistance
- Good oil and weathering resistance
- Resistant to UV radiation and ozone
- Thermal class B
- Easy to assemble
- The materials used during manufacturing
are cadmium-free, contain no silicone
and are free from substances harmful
to the wetting properties of lacquers

Note

For more information, especially on
custom cables and connectivity
solutions, please contact us:
wind@helukabel.de

Application

This special cable can be used as a generator connecting cable in wind power plants, for example. Other areas of application: Connecting cable for temperature class B (130°C) in the case of motors, transformers, relays, coils, magnets, and so on. Unit connections in the automotive industry. Halogen-free wiring of switchgear and control cabinets. Connecting cable for heating equipment. Supply line for high-power lighting in industry, sports centres and street lighting.

☑️ = Product conforms with Low-Voltage Directive 2014/35/EU.

Part no.	No. cores x cross-sec. mm ²	AWG-No.	Outer Ø app. mm	Cop. weight kg / km	Weight app. kg / km
75486	1 x 6	-	5,4	58,0	70,0
75487	1 x 10	-	6,8	96,0	119,0
75488	1 x 16	-	8,5	154,0	180,0
75489	1 x 25	-	10,3	240,0	270,0
75490	1 x 35	-	11,8	336,0	373,0
75491	1 x 50	-	13,9	480,0	528,0
75492	1 x 70	-	16,0	672,0	728,0

Part no.	No. cores x cross-sec. mm ²	AWG-No.	Outer Ø app. mm	Cop. weight kg / km	Weight app. kg / km
75493	1 x 95	-	17,3	912,0	966,0
75494	1 x 120	-	20,0	1152,0	1230,0
75495	1 x 150	-	22,1	1440,0	1530,0
71437	1 x 185	-	24,8	1776,0	2106,3
75496	1 x 240	-	27,7	2304,0	2583,8
706557	1 x 300	-	30,0	2880,0	3910,0
706558	1 x 400	-	38,7	3840,0	4870,0

Dimensions and specifications may be changed without prior notice.

N2XH

power cable, 0,6/1 kV, halogen free, without functionality

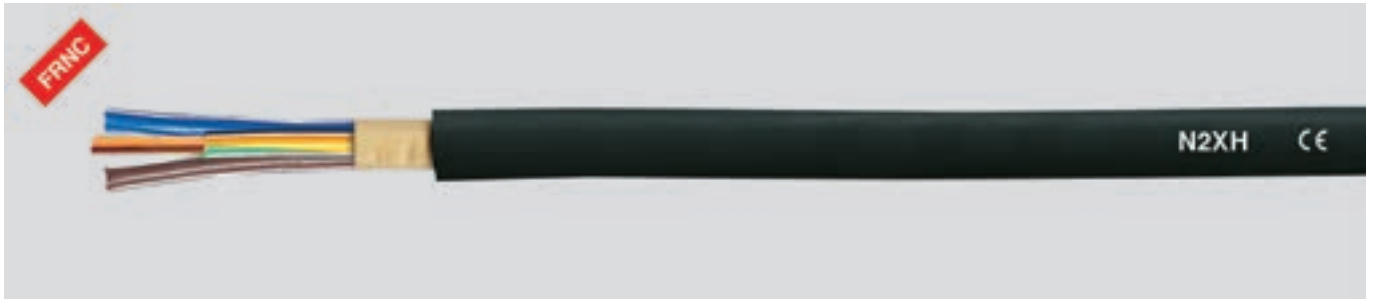

Technical data

- Power and control cable acc. to DIN VDE 0276 part 604, HD 604 S1 part 1 and part 5G
- **Temperature range**
during installation -5°C to +50°C
fixed installation -30°C to +90°C
- Permissible conductor **operating temperature** +90°C
- **Nominal voltage**
U₀/U 0,6/1 kV
- **Test voltage**
4 kV
- **Minimum bending radius**
single-core 15x cable Ø
multi-core 12x cable Ø
- **Radiation resistance**
up to 100x10⁶ cJ/kg (up to 100 Mrad)
- **Caloric load values**
see "Technical Informations"

Cable structure

- Bare copper conductor, to DIN VDE 0295 cl.1 or cl.2, single-wire or multi-wire, BS 6360 cl.1 or cl.2, IEC 60228 cl.1 or cl.2
- Core insulation of cross-linked polyethylene (XLPE) compound type 2X11 to HD 604 S1
- Core identification to DIN VDE 0293-308
- Core identification for 3+½ conductor
J-type: GN-YE (½), BN, BK, GY
O-type: BU (½), BN, BK, GY
- Cores stranded in layers (for multi-core cables)
- Overall filled inner sheath
- Covered by filling compound or taping
- Outer sheath of thermoplastic polyolefine, compound type HM4 to HD 604 S1
- Sheath colour: black

Properties

- Halogen-free, no separation of corrosive or toxic gases
- Limited propagation of fire
- Low smoke development
- The materials used during manufacturing are cadmium-free, contain no silicone and are free from substances harmful to the wetting properties of lacquers

Tests

- Flame test acc. to DIN VDE 0482-332-3-24, BS 4066 part 3, DIN EN 60332-3-24, IEC 60332-3-24 (previously DIN VDE 0472 part 804 test method C)
- Corrosiveness of combustion gases acc. to DIN VDE 0482 part 267, DIN EN 50267-2-2, IEC 60754-2 (equivalent DIN VDE 0472 part 813)
- Halogen-free acc. to DIN VDE 0482 part 267, DIN EN 50267-2-1, IEC 60754-1 (equivalent DIN VDE 0472 part 815)
- Smoke density acc. to DIN VDE 0482 part 1034-1+2, DIN EN 61034-1+2, IEC 61034-1+2, BS 7622 part 1+2 (previously DIN VDE 0472 part 816)

Note

- re = round conductor, single-wire
rm = round conductor, multi-wire
sm = sectional conductor, multi-wire
- J-version = with GN-YE conductor
O-version = without GN-YE conductor
- AWG sizes are approximate equivalent values. The actual cross section is in mm².
- **LSOH** = Low Smoke Zero Halogen

Application

Halogen-free power cables with enhanced characteristics in case of fire are used for applications where harm to human life and damage to property must be prevented in the event of fire, e. g. in power stations, industrial installations, communal establishments, hotels, airports, underground stations, railway stations, hospitals department stores, banks, schools theaters, multi-storey buildings, process control centres etc. Suitable for fixed installation in dry, damp or wet environments, in, above, on and beneath plaster as well as in masonry walls and in concrete. These cables are suitable for outdoor applications and in underground by using in conduits or tubes. For the installation in conduit all precautions must be taken that no accumulation of water can occur in the pipes.

CE = Product conforms with Low-Voltage Directive 2014/35/EU.

Part no.	No. cores x cross-sec.	Outer Ø	Cop.	Weight	AWG-No.	Part no.	No. cores x cross-sec.	Outer Ø	Cop.	Weight	AWG-No.	
J type	O type	app. mm	weight	app.		J type	O type	app. mm	weight	app.		
	mm ²		kg / km	kg / km			mm ²		kg / km	kg / km		
	1 x 1,5 rm	6,0	14,4	41,0	16	53114	53262	2 x 1,5 re	12,0	29,0	185,0	
	1 x 2,5 rm	6,5	24,0	53,0	14	53115	53263	2 x 2,5 re	12,2	48,0	220,0	
53100	53248	1 x 4 re	8,0	39,0	68,0	12	53116	53264	2 x 4 re	13,2	77,0	275,0
53101	53249	1 x 6 re	9,0	58,0	90,0	10	53117	53265	2 x 6 re	14,1	115,0	335,0
53102	53250	1 x 10 re	9,0	96,0	140,0	8	53118	53266	2 x 10 re	16,2	192,0	450,0
53103	53251	1 x 16 re	10,0	154,0	190,0	6	53119	53267	2 x 16 re	17,8	307,0	620,0
53104	53252	1 x 25 rm	11,0	240,0	290,0	4	53120	53268	2 x 25 rm	21,0	480,0	930,0
53105	53253	1 x 35 rm	12,0	336,0	390,0	2						
53106	53254	1 x 50 rm	15,0	480,0	510,0	1						
53107	53255	1 x 70 rm	17,0	672,0	710,0	2/0						
53108	53256	1 x 95 rm	19,0	912,0	960,0	3/0						
53109	53257	1 x 120 rm	21,0	1152,0	1200,0	4/0						
53110	53258	1 x 150 rm	23,0	1440,0	1480,0	300 kcmil						
53111	53259	1 x 185 rm	25,0	1776,0	1910,0	350 kcmil						
53112	53260	1 x 240 rm	28,0	2304,0	2370,0	500 kcmil						
53113	53261	1 x 300 rm	30,0	2880,0	2970,0	600 kcmil						
52485	52486	1 x 400 rm	32,9	3840,0	3957,0	750 kcmil						

Continuation ▶

N2XH

power cable, 0,6/1 kV, halogen free, without functionality



Part no. J type	O type	No.cores x cross-sec. mm ²	Outer Ø app. mm	Cop. weight kg / km	Weight app. kg / km	AWG-No.
53121	53269	3 x 1,5 re	13,0	43,0	220,0	16
53122	53270	3 x 2,5 re	14,0	72,0	280,0	14
53123	53271	3 x 4 re	15,0	115,0	350,0	12
53124	53272	3 x 6 re	16,0	173,0	420,0	10
53125	53273	3 x 10 re	18,0	288,0	600,0	8
53126	53274	3 x 16 re	20,0	461,0	770,0	6
53127	53275	3 x 25 rm	21,8	720,0	1120,0	4
53128	53276	3 x 35 sm	24,9	1008,0	1550,0	2
53129	53277	3 x 50 sm	25,2	1440,0	1750,0	1
53130	53278	3 x 70 sm	29,2	2016,0	2450,0	2/0
53131	53279	3 x 95 sm	32,0	2736,0	3250,0	3/0
53132	53280	3 x 120 sm	34,9	3456,0	4000,0	4/0
53133	53281	3 x 150 sm	39,2	4320,0	5000,0	300 kcmil
53134	53282	3 x 185 sm	44,1	5328,0	6150,0	350 kcmil
53135	53283	3 x 240 sm	49,2	6912,0	8000,0	500 kcmil
53143	53284	4 x 1,5 re	13,0	58,0	235,0	16
53144	53285	4 x 2,5 re	14,0	96,0	290,0	14
53145	53286	4 x 4 re	15,0	154,0	370,0	12
53146	53287	4 x 6 re	16,0	230,0	470,0	10
53147	53288	4 x 10 re	18,0	384,0	670,0	8
53148	53289	4 x 16 re	20,0	614,0	930,0	6
53149	53290	4 x 25 rm	25,0	960,0	1440,0	4
53150	53291	4 x 35 sm	27,0	1344,0	1890,0	2
53151	53292	4 x 50 sm	28,0	1920,0	2300,0	1
53152	53293	4 x 70 sm	32,0	2688,0	3200,0	2/0
53153	53294	4 x 95 sm	36,0	3648,0	4250,0	3/0
53154	53295	4 x 120 sm	40,2	4608,0	5350,0	4/0
53155	53296	4 x 150 sm	45,8	5760,0	6550,0	300 kcmil
53156	53297	4 x 185 sm	49,5	7104,0	8100,0	350 kcmil
53157	53298	4 x 240 sm	56,0	9216,0	10550,0	500 kcmil
53158	53299	5 x 1,5 re	14,5	72,0	280,0	16
53159	53309	5 x 2,5 re	16,0	120,0	350,0	14
53160	53310	5 x 4 re	17,0	192,0	450,0	12
53161	53311	5 x 6 re	18,5	288,0	600,0	10
53162	53312	5 x 10 re	21,0	480,0	850,0	8
53163	53313	5 x 16 re	24,0	768,0	1200,0	6
53557		5 x 25 rm	28,0	1200,0	1539,0	4
53164	53314	7 x 1,5 re	15,5	101,0	350,0	16
53171	53315	7 x 2,5 re	17,0	168,0	370,0	14
53178	53316	7 x 4 re	17,2	269,0	530,0	12
53165	53317	10 x 1,5 re	18,5	144,0	480,0	16
53172	53318	10 x 2,5 re	20,0	240,0	500,0	14
53166	53319	12 x 1,5 re	19,0	173,0	520,0	16
53173	53320	12 x 2,5 re	21,0	288,0	560,0	14
53179	53321	12 x 4 re	21,2	461,0	800,0	12
53167	53322	14 x 1,5 re	20,0	202,0	550,0	16
53174	53323	14 x 2,5 re	22,0	336,0	630,0	14
53168	53324	19 x 1,5 re	22,0	274,0	700,0	16
53175	53325	19 x 2,5 re	24,0	456,0	800,0	14
53169	53326	24 x 1,5 re	25,0	346,0	850,0	16
53176	53327	24 x 2,5 re	27,0	576,0	990,0	14
53170	53328	30 x 1,5 re	26,0	432,0	950,0	16
53177	53329	30 x 2,5 re	28,0	720,0	1180,0	14

Part no. J type	O type	No.cores x cross-sec. mm ²	Outer Ø app. mm	Cop. weight kg / km	Weight app. kg / km	AWG-No.
53136	53330	3 x 50 / 25 sm	28,5	1680,0	2100,0	1
53137	53331	3 x 70 / 35 sm	31,4	2352,0	2800,0	2/0
53138	53332	3 x 95 / 50 sm	34,9	3216,0	3750,0	3/0
53139	53333	3 x 120 / 70 sm	38,0	4128,0	4750,0	4/0
53140	53334	3 x 150 / 70 sm	43,3	4992,0	5750,0	300 kcmil
53141	53335	3 x 185 / 95 sm	47,2	6240,0	7200,0	350 kcmil
53142	53336	3 x 240 / 120 sm	53,4	8064,0	9300,0	500 kcmil

Dimensions and specifications may be changed without prior notice. (RQ02)

Single 600-J / -O

special single core cable, 600 V, meter marking



Technical data

- Special PVC single core acc. to UL Style 10107 and CSA AWM I/II A/B, adapted to DIN VDE 0285-525-2-31 / DIN EN 50525-2-31, DIN VDE 0285-525-2-51 / DIN EN 50525-2-51, acc. to UL Std.758
- **Temperature range**
flexing -5°C bis +90°C
fixed installation -40°C bis +90°C
- Permissible conductor **operating temperature** +90°C
- **Nominal voltage**
VDE U₀/U 600/1000 V
UL/CSA 600 V
- **Test voltage**
4000 V
- **Breakdown voltage**
min. 8000 V
- **Minimum bending radius**
flexing 7,5x cable Ø
fixed installation 4x cable Ø
- **Radiation resistance**
up to 80x10⁶ cJ/kg (up to 80 Mrad)

Cable structure

- Bare copper, fine wire conductors to DIN VDE 0295 cl.5, BS 6360 cl.5 and IEC 60228 cl.5
- Core insulation of special PVC to class 43, 90°C acc. to UL Std.1581 colour black or green-yellow
- Outer sheath of special PVC compound type TM2 to DIN VDE 0207-363-4-1/ DIN EN 50363-4-1 and class 43 acc. to UL Std.1581
- Sheath colour: black (RAL 9005)
- With meter marking

Properties

- Chemical Resistance
see "Technical Informations"
 - The materials used during manufacturing are cadmium-free, contain no silicone and are free from substances harmful to the wetting properties of lacquers
 - UV resistant
- Tests**
- PVC self-extinguishing and flame retardant acc. to DIN VDE 0482-332-1-2, DIN EN 60332-1-2, IEC 60332-1-2 (equivalent DIN VDE 0472 part 804 test method B), UL VW-1, CSA FT1

Note

- G = green-yellow
x = black
- AWG sizes are approximate equivalent values. The actual cross section is in mm².
- Screened analogue type:
Single 600-CY-J / -O
- Also as 1000 V Style 10678 deliverable

Application

PVC Single cores suitable for installation for flexible use for medium mechanical stresses with free movement without tensile stress or forced movements in dry, moist and wet rooms as well as outside (fixed installation). Is not suitable to be used as direct burial- or as underwater cable. These two norms approved single cores designed for exportorientated machinery manufacturer for machine tools, conveyor belts and production lines.

CE = Product conforms with Low-Voltage Directive 2014/35/EU.

Part no.	No. cores x cross-sec. mm ²	AWG-No.	Core colour	Outer Ø app. mm	Cop. weight kg / km	Weight app. kg / km
10881	1 G 6	10	green-yellow	7,8	58,0	118,0
10882	1 x 6	10	black	7,8	58,0	118,0
10883	1 G 10	8	green-yellow	9,0	96,0	180,0
10884	1 x 10	8	black	9,0	96,0	180,0
10885	1 G 16	6	green-yellow	10,0	154,0	250,0
10886	1 x 16	6	black	10,0	154,0	250,0
10887	1 G 25	4	green-yellow	11,5	240,0	370,0
10888	1 x 25	4	black	11,5	240,0	370,0
10889	1 G 35	2	green-yellow	13,0	336,0	490,0
10890	1 x 35	2	black	13,0	336,0	490,0
10891	1 G 50	1	green-yellow	15,6	480,0	665,0
10892	1 x 50	1	black	15,6	480,0	665,0

Part no.	No. cores x cross-sec. mm ²	AWG-No.	Core colour	Outer Ø app. mm	Cop. weight kg / km	Weight app. kg / km
10893	1 G 70	2/0	green-yellow	17,9	672,0	910,0
10894	1 x 70	2/0	black	17,9	672,0	910,0
10895	1 G 95	3/0	green-yellow	19,5	912,0	1195,0
10896	1 x 95	3/0	black	19,5	912,0	1195,0
10897	1 G 120	4/0	green-yellow	22,3	1152,0	1545,0
10898	1 x 120	4/0	black	22,3	1152,0	1545,0
10899	1 G 150	250 kcmil	green-yellow	25,0	1440,0	1750,0
10900	1 x 150	250 kcmil	black	25,0	1440,0	1750,0
10901	1 G 185	350 kcmil	green-yellow	28,6	1776,0	2320,0
10902	1 x 185	350 kcmil	black	28,6	1776,0	2320,0
10903	1 G 240	450 kcmil	green-yellow	31,4	2304,0	2960,0
10904	1 x 240	450 kcmil	black	31,4	2304,0	2960,0

Dimensions and specifications may be changed without prior notice. (RN06)

Single 600-CY-J / -O

special single core cable, 600 V, Cu-screened, EMC-preferred type, meter marking

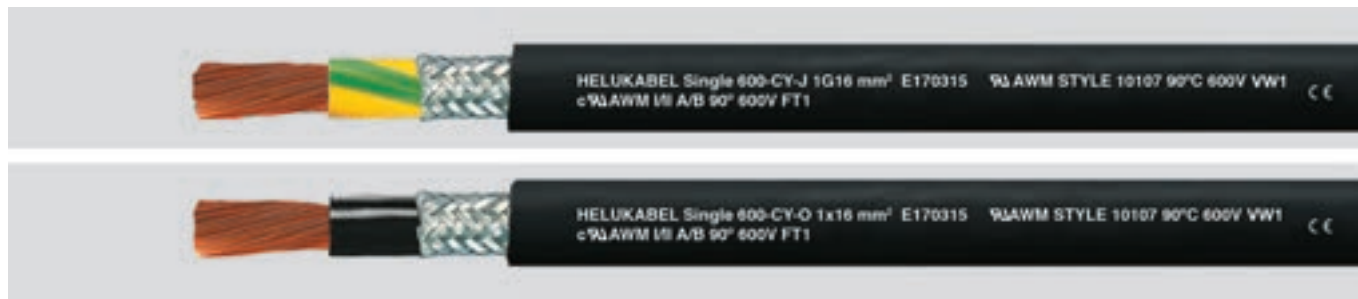

Technical data

- Special PVC single cores acc. to UL Style 10107 and CSA AWM I/II A/B, adapted to DIN VDE 0285-525-2-31 / DIN EN 50525-2-31, DIN VDE 0285-525-2-51 / DIN EN 50525-2-51, acc. to UL Std.758
- **Temperature range**
flexing -5°C bis +90°C
fixed installation -40°C bis +90°C
- Permissible conductor **operating temperature** +90°C
- **Nominal voltage**
VDE U₀/U 600/1000 V
UL/CSA 600 V
- **Test voltage**
4000 V
- **Breakdown voltage**
min. 8000 V
- **Minimum bending radius**
flexing 7,5x cable Ø
fixed installation 4x cable Ø
- **Coupling resistance**
max. 250 Ohm/km
- **Radiation resistance**
up to 80x10⁶ cJ/kg (up to 80 Mrad)

Cable structure

- Bare copper, fine wire conductors, to DIN VDE 0295 cl.5, BS 6360 cl.5 and IEC 60228 cl.5
- Core insulation of special PVC to class 43, 90°C acc. to UL Std.1581 colour black or green-yellow
- Tinned copper braided screening, coverage approx. 85%
- Outer sheath special PVC compound type TM2 to DIN VDE 0207-363-4-1 / DIN EN 50363-4-1 and class 43 acc. to UL Std.1581
- Sheath colour: black (RAL 9005)
- With meter marking

Properties

- Chemical Resistance see "Technical Informations"
- The materials used during manufacturing are cadmium-free, contain no silicone and are free from substances harmful to the wetting properties of lacquers
- UV resistant

Tests

- PVC self-extinguishing and flame retardant acc. to DIN VDE 0482-332-1-2, DIN EN 60332-1-2, IEC 60332-1-2 (equivalent DIN VDE 0472 part 804 test method B), UL VW-1, CSA FT1

Note

- G = green-yellow
x = black
- AWG sizes are approximate equivalent values. The actual cross section is in mm².
- Unscreened analogue type:
Single 600-J / -O
- Also as 1000 V Style 10678 deliverable

Application

PVC single cores suitable for installation for flexible use for medium mechanical stresses with free movement without tensile stress or forced movements in dry, moist and wet rooms as well as outside (fixed installation). Is not suitable to be used as direct burial-or as underwater cable. These two norms approved single cores designed for exportorientated machinery manufacturer for machine tools, conveyor belts and production lines. These screened cables are particularly suitable for the interference-free transmission in instrumentation and control engineering applications (electromagnetic compatibility).

EMC = Electromagnetic compatibility

To optimize the EMC features we recommend a large round contact of the copper braiding on both ends.

CE = Product conforms with Low-Voltage Directive 2014/35/EU.

Part no.	No. cores x cross-sec. mm ²	AWG-No.	Core colour	Outer Ø app. mm	Cop. weight kg / km	Weight app. kg / km
10910	1 G 6	10	green-yellow	7,6	72,0	140,0
10911	1 x 6	10	black	7,6	72,0	140,0
10912	1 G 10	8	green-yellow	9,4	130,0	230,0
10913	1 x 10	8	black	9,4	130,0	230,0
10914	1 G 16	6	green-yellow	10,4	190,0	300,0
10915	1 x 16	6	black	10,4	190,0	300,0
10916	1 G 25	4	green-yellow	12,0	260,0	420,0
10917	1 x 25	4	black	12,0	260,0	420,0
10918	1 G 35	2	green-yellow	14,4	405,0	615,0
10919	1 x 35	2	black	14,4	405,0	615,0
10920	1 G 50	1	green-yellow	16,4	560,0	825,0
10921	1 x 50	1	black	16,4	560,0	825,0

Part no.	No. cores x cross-sec. mm ²	AWG-No.	Core colour	Outer Ø app. mm	Cop. weight kg / km	Weight app. kg / km
10922	1 G 70	2/0	green-yellow	17,4	780,0	1090,0
10923	1 x 70	2/0	black	17,4	780,0	1090,0
10924	1 G 95	3/0	green-yellow	20,1	1030,0	1395,0
10925	1 x 95	3/0	black	20,1	1030,0	1395,0
10926	1 G 120	4/0	green-yellow	23,0	1285,0	1770,0
10927	1 x 120	4/0	black	23,0	1285,0	1770,0
10928	1 G 150	250 kcmil	green-yellow	26,1	1570,0	1930,0
10929	1 x 150	250 kcmil	black	26,1	1570,0	1930,0
10930	1 G 185	350 kcmil	green-yellow	29,3	1940,0	2635,0
10931	1 x 185	350 kcmil	black	29,3	1940,0	2635,0
10932	1 G 240	450 kcmil	green-yellow	32,2	2530,0	3380,0
10933	1 x 240	450 kcmil	black	32,2	2530,0	3380,0

Dimensions and specifications may be changed without prior notice. (RN06)



HELUWIND® WK POWERLINE ALU 105°C, 1,8/3kV

HELUWIND® WK POWERLINE ALU halogenfree, 105°C 1,8/3kV

HELUWIND® WK RHH/RHW-2 ALU

HELUWIND® WK POWERLINE ALU robust 105°C, 1,8/3kV



■ ALUMINIUM POWER CABLES

Designation	Page
Aluminium power cables 0,6/1kV	68
NAYY	68
NAY2Y	70
NA2XY	71
HELWIND® WK (N)A2XH	72
HELWIND® WK ALU Tower	73
HELWIND® WK ALU Blade	74
HELWIND® WK POWERLINE ALU	75
HELWIND® WK POWERLINE ALU robust	76
Aluminium power cables 1,8/3kV	77
HELWIND® WK POWERLINE ALU 105°C	77
HELWIND® WK POWERLINE ALU robust 105°C	78
HELWIND® WK POWERLINE ALU halogen-free 105°C	79
HELWIND® WK RHH/RHW-2 ALU	80



Technical data

- Power and control cable to DIN VDE 0276 part 603, HD 603 S1 and IEC 60502
- Insulation and sheath-compound of thermoplastic PVC
- **Temperature range**
flexing -5°C to +50°C
fixed installation -40°C to +70°C
- Permissible conductor **operating temperature** +70°C
- Permissible **short circuit temperature** (short circuit duration max. 5 s)
≤ 300 mm² +160°C
> 300 mm² +140°C
- **Nominal voltage**
U₀/U 0,6/1 kV
- **Test voltage**
4 kV
- Max. permissible **tensile stress** with cable grip at conductor
30 N/mm²
- **Current carrying capacity** to DIN VDE 0276 part 603, in normal operation table 14 and 15, under short circuit conditions table 17
- **Minimum bending radius**
single-core 15x cable Ø
multi-core 12x cable Ø
- **Caloric load values**
see "Technical Informations"

Cable structure

- Aluminium-conductor, to DIN VDE 0295 cl.1 or cl.2, single-wire or multi-wire, BS 6360 cl.1 or cl.2, IEC 60228 cl.1 or cl.2
- Core insulation of PVC compound type DIV4 to HD 603 S1
- Core identification to DIN VDE 0293-308, 0276 part 603
- Cores stranded in concentric layers
- Common core sheath
- Outer sheath of PVC compound type DMV5 to HD 603 S1
- Sheath colour: black

Properties

- The materials used during manufacturing are cadmium-free, contain no silicone and are free from substances harmful to the wetting properties of lacquers

Tests

- PVC self-extinguishing and flame retardant acc. to DIN VDE 0482-332-1-2, DIN EN 60332-1-2, IEC 60332-1-2 (equivalent DIN VDE 0472 part 804 test method B)

Highest permissible voltage

- Direct current systems 1,8 kV
- Alternating current systems
 - Single-phase systems
both outer conductors insulated 1,4 kV
 - Single-phase systems
one outer conductor earthed 0,7 kV
- Three-phase systems 1,2 kV

Note

- re = round conductor, single-wire
- rm = round conductor, multi-wire
- se = sectional conductor, single-wire
- sm = sectional conductor, multi-wire
- J-version = with GN-YE conductor
- O-version = without GN-YE conductor
- AWG sizes are approximate equivalent values. The actual cross section is in mm².

Application

Power cables for energy supply are installed in open air, in underground, in water, in concrete, indoors, in cable ducts, power stations, for industry and distribution boards as well as in subscriber networks, where mechanical damages are not be expected.

☑ = Product conforms with Low-Voltage Directive 2014/35/EU.

No. cores x cross-sec. mm ²	Outer Ø app. mm	Alu weight kg / km	Weight app. kg / km	J type Part no.	AWG-No.	O type Part no.	AWG-No.
4 x 16 re	23,0	186,0	750,0	32301	6	32184	6
4 x 25 re	26,0	290,0	950,0	32302	4	32185	4
4 x 35 re	28,5	406,0	1120,0	32303	2	32186	2
4 x 50 se	30,0	580,0	1151,0	32304	1	32187	1
4 x 70 se	35,0	812,0	1549,0	32305	2/0	32188	2/0
4 x 95 se	39,5	1102,0	2030,0	32306	3/0	32189	3/0
4 x 95 sm	39,5	1102,0	2030,0	32177	3/0	32190	3/0
4 x 120 se	44,0	1392,0	2400,0	32307	4/0	32191	4/0
4 x 120 sm	44,0	1392,0	2400,0	32178	4/0	32192	4/0
4 x 150 se	46,0	1740,0	3030,0	32308	300 kcmil	32193	300 kcmil
4 x 150 sm	46,0	1740,0	3030,0	32179	300 kcmil	32194	300 kcmil
4 x 185 se	51,0	2146,0	3650,0	32309	350 kcmil	32195	350 kcmil
4 x 185 sm	51,0	2146,0	3650,0	32180	350 kcmil	32196	350 kcmil
4 x 240 se	56,0	2784,0	4800,0	32310	500 kcmil	32197	500 kcmil
4 x 240 sm	56,0	2784,0	4800,0	32181	500 kcmil	32198	500 kcmil
4 x 300 se	64,0	3480,0	5596,0	32182	600 kcmil	32199	600 kcmil
4 x 300 sm	64,0	3480,0	5596,0	32183	600 kcmil	32258	600 kcmil

Continuation ▶

No. cores x cross-sec. mm ²		Outer Ø app. mm	Alu weight kg / km	Weight app. kg / km	J type Part no.	AWG-No.		O type Part no.	AWG-No.	
5 x 10	re	22,0	145,0	637,0	33275	8	-	33283	8	-
5 x 16	re	25,0	232,0	832,0	33276	6	-	33284	6	-
5 x 25	re	28,0	363,0	1175,0	33277	4	-	33285	4	-
5 x 35	re	31,0	508,0	1399,0	33278	2	-	33286	2	-
5 x 50	rm	35,0	725,0	1855,0	33279	1	-	33287	1	-
5 x 70	rm	40,0	1015,0	2351,0	33280	2/0	-	33288	2/0	-
5 x 95	rm	45,0	1378,0	3071,0	33281	3/0	-	33289	3/0	-
5 x 120	rm	49,0	1740,0	3631,0	33282	4/0	-	33290	4/0	-
5 x 150	rm	57,8	2175,0	4405,0	34041	300 kcmil	-	34042	300 kcmil	-
5 x 185	rm	61,5	2683,0	5420,0	34043	350 kcmil	-	34044	350 kcmil	-
5 x 240	rm	70,0	3480,0	6860,0	34045	500 kcmil	-	34046	500 kcmil	-

No. cores x cross-sec. mm ²		Outer Ø app. mm	Alu weight kg / km	Weight app. kg / km	J type Part no.	AWG-No.		O type Part no.	AWG-No.	
1 x 35	re	13,0	102,0	240,0	32328	2	-	32311	2	-
1 x 50	re	15,0	145,0	360,0	32329	1	-	32312	1	-
1 x 70	rm	16,5	203,0	410,0	32390	2/0	-	32313	2/0	-
1 x 95	rm	19,0	276,0	570,0	32391	3/0	-	32314	3/0	-
1 x 120	rm	20,5	348,0	691,0	32392	4/0	-	32315	4/0	-
1 x 150	rm	22,5	435,0	804,0	32393	300 kcmil	-	32321	300 kcmil	-
1 x 185	rm	25,0	537,0	979,0	32394	350 kcmil	-	32322	350 kcmil	-
1 x 240	rm	28,0	696,0	1253,0	32395	500 kcmil	-	32323	500 kcmil	-
1 x 300	rm	30,0	870,0	1395,0	32396	600 kcmil	-	32324	600 kcmil	-
1 x 400	rm	34,0	1160,0	1890,0	32397	750 kcmil	-	32325	750 kcmil	-
1 x 500	rm	38,0	1450,0	2600,0	32398	1000 kcmil	-	32326	1000 kcmil	-
1 x 630	rm	43,0	1827,0	2780,0	32399	1250 kcmil	-	32327	1250 kcmil	-

Dimensions and specifications may be changed without prior notice. (RQ01)

NAY2Y

power cable, 0,6/1 kV, with PE-outer sheath



Technical data

- Power and control cable to DIN VDE 0276 part 603, HD 603 S1 and IEC 60502
- **Temperature range**
flexing -5°C to +50°C
fixed installation -40°C to +70°C
- Permissible conductor **operating temperature** +70°C
- Permissible **short circuit temperature** (short circuit duration max. 5 s) +160°C
- **Nominal voltage**
U₀/U 0,6/1 kV
- **Test voltage**
4 kV
- Max. permissible **tensile stress** with cable grip at conductor 30 N/mm²
- **Minimum bending radius**
12x cable Ø

Cable structure

- Aluminium-conductor, to DIN VDE 0295 cl.1, single-wire, BS 6360 cl.1, IEC 60228 cl.1
- Core insulation of PVC
- Core identification GN-YE, BN, BK, GY
- Cores stranded in concentric layers
- Common core sheath
- Outer sheath of PE
- Sheath colour: black

Properties

- Outer sheath PE of not self-extinguishing and flame retardant
- The materials used during manufacturing are cadmium-free, contain no silicone and are free from substances harmful to the wetting properties of lacquers
- **Highest permissible voltage**
 - Direct current systems 1,8 kV
 - Alternating current systems
 - Single-phase systems both outer conductors insulated 1,4 kV
 - Single-phase systems one outer conductor earthed 0,7 kV
- Three-phase systems 1,2 kV

Note

- re = round conductor, single-wire
- se = sectional conductor, single-wire
- AWG sizes are approximate equivalent values. The actual cross section is in mm².

Application

Power cables for energy supply are installed in open air, in underground, in water, in concrete, indoors, in cable ducts, power stations, for industry and distribution boards as well as in subscriber networks. Usable in extreme working conditions due to the robust PE outer sheath.

☑️ = Product conforms with Low-Voltage Directive 2014/35/EU.

Part no.	No. cores x cross-sec. mm ²	Outer Ø app. mm	Alu weight kg / km	Weight app. kg / km	AWG-No.
31129	4 x 25 re	26,0	290,0	970,0	4
31139	4 x 35 re	28,0	406,0	1145,0	2
31149	4 x 50 se	30,0	580,0	1184,0	1
31159	4 x 70 se	33,0	812,0	1578,0	2/0
31169	4 x 95 se	38,0	1102,0	2186,0	3/0
31179	4 x 120 se	42,0	1382,0	2501,0	4/0
31189	4 x 150 se	45,0	1740,0	3180,0	300 kcmil
31199	4 x 185 se	51,0	2146,0	3807,0	350 kcmil
31209	4 x 240 se	55,0	2784,0	4996,0	500 kcmil

Dimensions and specifications may be changed without prior notice. (RQ01)

NA2XY

power cable, 0,6/1 kV, VDE approved, current-carrying capacity



Technical data

- Power and control cable to DIN VDE 0276 Part 603, HD 603 S1 and IEC 60502
- **Temperature range**
flexing -5°C to +50°C
fixed installation -40°C to +70°C
- Permissible conductor **operating temperature** +90°C
- Permissible **short circuit temperature** (short circuit duration max. 5 s) +250°C
- **Nominal voltage**
 U_0/U 0,6/1 kV
- **Test voltage**
4 kV
- Max. permissible **tensile stress** with cable grip at conductor 30 N/mm²
- **Minimum bending radius**
single-core 15x cable Ø
multi-core 12x cable Ø

Cable structure

- Aluminium-conductor to DIN VDE 0295 cl.1 or cl.2, single-wire or multi-wire, BS 6360 cl.1 or cl.2, IEC 60228 cl.1 or cl.2
- Core insulation of cross-linked polyethylene (XLPE) compound type DIX3 to HD 603 S1
- Core identification to DIN VDE 0293-308, 0276 part 603
- Cores stranded in concentric layers
- Outer sheath of PVC compound type DMV6/DMP2 to HD 603 S1
- Sheath colour: black

Properties

- The materials used during manufacturing are cadmium-free, contain no silicone and are free from substances harmful to the wetting properties of lacquers

Tests

- Self-extinguishing and flame retardant acc. to DIN VDE 0482-332-1-2, DIN EN 60332-1-2, IEC 60332-1-2 (equivalent DIN VDE 0472 part 804 test method B)

Highest permissible voltage

- Direct current systems 1,8 kV
- Alternating current systems
 - Single-phase systems
both outer conductors insulated 1,4 kV
 - Single-phase systems
one outer conductor earthed 0,7 kV
- Three-phase systems 1,2 kV

Note

- re = round conductor, single-wire
rm = round conductor, multi-wire
se = sectional conductor, single-wire
- J-version = with GN-YE conductor
O-version = without GN-YE conductor
- AWG sizes are approximate equivalent values. The actual cross section is in mm².

Application

Power distribution cables for use in underground, in water, outdoors, in concrete, indoors, in cable ducts, for power stations, industrial applications and switching systems, as well as in local networks if no mechanical damage is expected. Respecting the permissible operating temperature at the conductor of +90°C permits a higher current carrying capacity than PVC insulated power distribution cables.

☑ = Product conforms with Low-Voltage Directive 2014/35/EU.

No. cores x cross-sec. mm ²		Outer Ø app. mm	Alu weight kg / km	Weight app. kg / km	J type Part no.	AWG-No.		O type Part no.	AWG-No.	
1 x 16	re	11,5	47,0	98,0	33113	6	-	33125	6	-
1 x 25	re	12,5	73,0	150,0	33114	4	-	33126	4	-
1 x 35	re	13,5	102,0	241,0	33115	2	-	33127	2	-
1 x 50	rm	15,5	145,0	357,0	33116	1	-	33128	1	-
1 x 70	rm	17,0	203,0	409,0	33117	2/0	-	33129	2/0	-
1 x 95	rm	19,0	276,0	570,0	33118	3/0	-	33130	3/0	-
1 x 120	rm	20,5	348,0	590,0	33119	4/0	-	33131	4/0	-
1 x 150	rm	23,0	435,0	804,0	33120	300 kcmil	-	33132	300 kcmil	-
1 x 185	rm	25,5	537,0	978,0	33121	350 kcmil	-	33133	350 kcmil	-
1 x 240	rm	28,5	696,0	1253,0	33122	500 kcmil	-	33134	500 kcmil	-
1 x 300	rm	30,0	870,0	1394,0	33123	600 kcmil	-	33135	600 kcmil	-
1 x 400	rm	34,0	1160,0	1890,0	33124	750 kcmil	-	33136	750 kcmil	-
4 x 16	re	21,5	186,0	750,0	33137	6	-	33147	6	-
4 x 25	re	26,0	290,0	950,0	33138	4	-	33148	4	-
4 x 35	re	27,5	406,0	1120,0	33139	2	-	33149	2	-
4 x 50	se	30,0	580,0	1251,0	33140	1	-	33150	1	-
4 x 70	se	34,0	812,0	1548,0	33141	2/0	-	33151	2/0	-
4 x 95	se	39,0	1102,0	2030,0	33142	3/0	-	33152	3/0	-
4 x 120	se	42,5	1392,0	2400,0	33143	4/0	-	33153	4/0	-
4 x 150	se	47,5	1740,0	3030,0	33144	300 kcmil	-	33154	300 kcmil	-
4 x 185	se	52,0	2146,0	3650,0	33145	350 kcmil	-	33155	350 kcmil	-
4 x 240	se	58,0	2784,0	4800,0	33146	500 kcmil	-	33156	500 kcmil	-

Dimensions and specifications may be changed without prior notice. (RQ02)

HELUWIND® WK (N)A2XH

0,6/1 kV, halogen-free



Technical data

- **Temperature range**
fixed installation -40°C to +90°C
during assembly -5°C to +50°C
- Permissible conductor **operating temperature** +90°C
- **Nominal voltage**
 U_0/U 0,6/1 V
- **Test voltage**
4 kV
- **Approvals**
production in acc. to VDE standards,
CE compliant
- **Minimum bending radius**
15x cable Ø
- **Flame test**
IEC 60332-3-24,
IEC 60332-1-2 cat. C
- **Smoke density**
IEC 61034-1-2
- **Corrosivity of combustion gases**
IEC 60754-2
- **Halogen-free**
IEC 60754-1
- **Current carrying capacity**
IEC 60364-5-52 Table B.5.2.13

Cable structure

- ALU conductors, stranded conductors
acc. to IEC 60228 cl.2
- Core insulation: cross-linked PE
- Core identification: black
- Sheath: thermoplastic polymer
- Sheath colour: black

Properties

- Halogen-free
- UV resistant

Note

For more information, especially on custom cables and connectivity solutions, please contact us:
wind@helukabel.de

Application

The HELUWIND® WK series was specifically designed for wind power applications. We supply the leading wind turbine manufacturers with our cables.

CE = Product conforms with Low-Voltage Directive 2014/35/EU.

Part no.	No. cores x cross-sec. mm ²	AWG-No.	Outer Ø app. mm	AL weight kg / km	Weight app. kg / km
712374	1 x 95	-	18,0	275,5	445,0
712589	1 x 150	-	20,0	435,0	950,0
705031	1 x 185	-	22,0	537,0	1100,0

Part no.	No. cores x cross-sec. mm ²	AWG-No.	Outer Ø app. mm	AL weight kg / km	Weight app. kg / km
705032	1 x 240	-	25,0	696,0	1208,0
705033	1 x 300	-	28,5	870,0	1342,0
705034	1 x 400	-	32,0	1160,0	1843,0

Dimensions and specifications may be changed without prior notice.

HELUWIND® WK ALU Tower

0,6/1 kV



Technical data

- **Temperature range**
flexing -25°C to +50°C
fixed installation -40°C to +90°C
- Permissible conductor **operating temperature** +90°C
- **Nominal voltage**
0,6/1 kV
- **Test voltage**
4 kV
- **Minimum bending radius**
15x cable Ø
- **Approvals**
acc. to IEC 60502-1

Cable structure

- ALU stranded round shaped conductors (RM)
acc. to IEC 60228 cl.2 (nv) annealed
- Insulation: EPR compound black
- Sheath: special PCP compound
- Sheath colour: black

Properties

- UV resistant
- Oil resistant

Note

For more information, especially on custom cables and connectivity solutions, please contact us:
wind@helukabel.de

Application

For medium mechanical stress in dry, damp and wet environments; for outdoor use; particularly as a power cable in wind turbines, for fixed installation in the tower or lattice tower. Due to the special cable structure, and outer sheath, this cable provides a better flexibility than standard cables (NAYY-NA2XY-NA2XH). Thanks to its increased flexibility, this cable is perfectly suited for connecting wind turbines and external substations (pipes). The cable is also available with a rated voltage of 1,8/3 kV.

☑ = Product conforms with Low-Voltage Directive 2014/35/EU.

Part no.	No. cores x cross-sec. mm ²	AWG-No.	Outer Ø app. mm	AL weight kg / km	Weight app. kg / km
708470	1 x 150	-	23,0	435,0	790,0
708471	1 x 185	-	26,0	537,0	960,0
709957	1 x 240	-	25,0	696,0	1100,0

Part no.	No. cores x cross-sec. mm ²	AWG-No.	Outer Ø app. mm	AL weight kg / km	Weight app. kg / km
708473	1 x 300	-	29,0	870,0	1342,0
708474	1 x 400	-	31,4	1160,0	1843,0

Dimensions and specifications may be changed without prior notice.

HELUWIND® WK ALU Blade

lightning protection, rotor blades



Technical data

- **Temperature range**
fixed installation -40°C to +80°C
- **Nominal voltage**
0,6/1 kV
- **Test voltage**
4 kV
- **Minimum bending radius**
fixed installation 15x cable Ø

Cable structure

- Aluminium conductor, with special conductor construction
- Special insulation compound
- Sheath colour: black

Properties

- Oil resistant
- UV resistant

Note

For more information, especially on custom cables and connectivity solutions, please contact us:
wind@helukabel.de

Application

This lightning protection cable is suitable for limited flexible applications despite its multi-stranding (class 2) aluminium conductor. This cable can be used in rotor blades of wind turbines.

CE = Product conforms with Low-Voltage Directive 2014/35/EU.

Part no.	No. cores x cross-sec. mm ²	AWG-No.	Outer Ø app. mm	AL weight kg / km	Weight app. kg / km
706576	1 x 50	-	12,1	160,0	376,0

Part no.	No. cores x cross-sec. mm ²	AWG-No.	Outer Ø app. mm	AL weight kg / km	Weight app. kg / km
706577	1 x 70	-	13,7	224,0	491,0

Dimensions and specifications may be changed without prior notice.

HELUWIND® WK POWERLINE ALU

0,6/1 kV, flexible ALU-Conductor



Technical data

- **Temperature range**
flexing -20°C to +90°C
fixed installation -40°C to +105°C
- Permissible conductor **operating temperature** +105°C up to 3000h
- **Nominal voltage**
0,6/1 kV
- **Test voltage**
4 kV
- **Minimum bending radius**
flexing 10x cable Ø
fixed installation 4x cable Ø
- **Flame test**
IEC 60332-1-2
- **Approvals**
acc. to DIN VDE 0250-813
UL/CSA in preparation

Cable structure

- Aluminium conductor, fine stranded wires
- Special insulation black
- Sheath: special compound
- Sheath colour: black

Properties

- UV resistant
- Oil resistant
- Easy to assemble
- Recyclable

Note

For more information, especially on custom cables and connectivity solutions, please contact us: wind@helukabel.de

Application

The WK POWERLINE ALU is a highly flexible aluminium cable with a finely stranded structure and is designed for use in the power engineering sector; specifically, for power cabling in wind power plants. Thanks to its high degree of flexibility and low tare weight, this cable can be fed into the tower as a single length. This eliminates the need for time-consuming cabling of each individual tower segment. However, its key advantage lies in the process reliability the connection technology offers: using this cable can reduce the number of interruptions between the topmost tower segment and the converter from 90 connection points to just 18 (depending on the number of power cables and tower segments). As a result, the amount of time required for installation can drop from several days to a few hours. For torsion applications, we recommend the WK 103-Torsion, WK 135-Torsion or WK 137-Torsion.

The HELUWIND® WK POWERLINE ALU may only be used with certified connection technology from HELUKABEL®. This includes C8 crimp connections and screwed connections; both described in the "Connection Technology" section and tested in accordance with IEC 61238-1 cl. A.

See the accessories section of the catalogue. The cable is also available with a halogen-free design, UL/CSA approval or a rated voltage of 1.8/3 kV. = Product conforms with Low-Voltage Directive 2014/35/EU.

Part no.	No. cores x cross-sec. mm ²	AWG-No.	Outer Ø app. mm	AL weight kg / km	Weight app. kg / km
707062	1 x 70	-	17,4	206,0	379,0
707063	1 x 95	-	18,8	280,0	480,0
707064	1 x 120	-	20,6	355,0	576,0
706408	1 x 150	-	22,4	441,0	665,0

Part no.	No. cores x cross-sec. mm ²	AWG-No.	Outer Ø app. mm	AL weight kg / km	Weight app. kg / km
706088	1 x 185	-	24,5	544,0	950,0
706089	1 x 240	-	27,5	706,0	1150,0
706084	1 x 300	-	31,9	882,0	1400,0
706085	1 x 400	-	36,7	1176,0	1680,0

Dimensions and specifications may be changed without prior notice.

HELUWIND® WK POWERLINE ALU robust

0,6/1 kV, flexible ALU-Conductor



Technical data

- **Temperature range**
flexing -20°C to +90°C
fixed installation -40°C to +105°C
- Permissible conductor **operating temperature** +105°C up to 3000h
- **Nominal voltage**
0,6/1 kV
- **Test voltage**
4 kV
- **Minimum bending radius**
flexing 10x cable Ø
fixed installation 4x cable Ø
- **Flame test**
IEC 60332-1-2
- **Approvals**
acc. to DIN VDE 0250-813
UL/CSA in preparation

Cable structure

- Aluminium conductor, fine stranded wires
- Special insulation black
- Sheath: special compound
- Sheath colour: black

Properties

- Extremely abrasion resistant
- UV resistant
- Oil resistant
- Easy to assemble
- Recyclable

Note

For more information, especially on custom cables and connectivity solutions, please contact us: wind@helukabel.de

Application

The WK POWERLINE ALU robust is a highly flexible aluminium cable with a finely stranded structure and is designed for use in the power engineering sector; specifically, for power cabling in wind power plants. An essential advantage of the WK POWERLINE ALU series is the highly mechanical resistance of the outer sheath. Thanks to its high degree of flexibility and low tare weight, this cable can be fed in the tower in one length. This eliminates the need for time-consuming cabling of each individual tower segment. However, its key advantage lies in the process reliability the connection technology offers: using this cable can reduce the number of interruptions between the topmost tower segment and the converter from 90 connection points to just 18 (depending on the number of power cables and tower segments). The amount of time required for installation can drop from several days to a few hours. For torsion applications, we recommend the WK 103-Torsion, WK 135-Torsion or WK 137-Torsion.

The HELUWIND® WK POWERLINE ALU may only be used with certified connection technology from HELUKABEL®. This includes C8 crimp connections and screwed connections; both described in the "Connection Technology" section and tested in accordance with IEC 61238-1 cl. A.

CE = Product conforms with Low-Voltage Directive 2014/35/EU.

Part no.	No. cores x cross-sec. mm²	AWG-No.	Outer Ø app. mm	AL weight kg / km	Weight app. kg / km
707097	1 x 70	-	17,4	206,0	460,0
707098	1 x 95	-	17,9	280,0	536,0
707099	1 x 120	-	20,6	355,0	576,0
707100	1 x 150	-	22,4	441,0	665,0

Part no.	No. cores x cross-sec. mm²	AWG-No.	Outer Ø app. mm	AL weight kg / km	Weight app. kg / km
707101	1 x 185	-	24,5	544,0	950,0
707102	1 x 240	-	28,1	706,0	1150,0
707103	1 x 300	-	31,4	882,0	1398,0
707104	1 x 400	-	36,7	1176,0	1588,0

Dimensions and specifications may be changed without prior notice.

HELUWIND® WK POWERLINE ALU

1,8/3 kV, flexible ALU-Conductor, direct burial



Technical data

- **Temperature range**
flexing -20°C to +90°C
fixed installation -40°C to +105°C
- Permissible conductor **operating temperature** +105°C up to 3000h
- **Nominal voltage**
1,8/3 kV
- **Test voltage**
9 kV
- **Minimum bending radius**
flexing 10x cable Ø
fixed installation 4x cable Ø
- **Flame test**
IEC 60332-1-2
- **Approvals**
in accordance DIN VDE 0250-813

Cable structure

- Aluminium conductor, fine stranded wires
- Special insulation black
- Sheath: special compound
- Sheath colour: black

Properties

- UV resistant
- Oil resistant
- Easy to assemble
- Recyclable
- Direct burial

Note

For more information, especially on custom cables and connectivity solutions, please contact us: wind@helukabel.de

Application

The HELUWIND® WK POWERLINE ALU is a highly flexible, aluminium cable with a finely stranded structure and is designed for use in the power engineering sector, specifically for power cabling in industrial applications. Thanks to its high level of flexibility and reduced weight, this cable is an interesting option compared to fine-stranded copper cables in many applications.

The HELUWIND® WK POWERLINE ALU series unlocks its full potential, when it comes to power wiring of wind power plants. Due to its low weight, cables can be fed through the tower in one length. This eliminates the need for the time-consuming cabling of individual tower segments. However, the key benefit is an increased reliability of the connection technology: The number of interruptions between the topmost tower segment and the converter can be reduced from 90 connection points to just 18 (depending on the number of power cables and tower segments). As a result, the amount of time required for installation can drop from several days, to a few hours. For torsion applications, we recommend the HELUWIND® WK 103-Torsion, WK 135-Torsion or WK 137-Torsion.

The HELUWIND® WK POWERLINE ALU may only be used with certified connection technology from HELUKABEL®. This includes C8 crimp connections and screwed connections; both described in the "Connection Technology" section and tested in accordance with IEC 61238-1 cl. A.

The cable is also available in a halogen-free design, with UL/CSA approval, and a rated voltage of 0.6/1 kV. The "robust" version features a high abrasion and mechanical load resistant PUR sheath.

☑ = Product conforms with Low-Voltage Directive 2014/35/EU.

Part no.	No. cores x cross-sec. mm ²	AWG-No.	Outer Ø app. mm	AL weight kg / km	Weight app. kg / km
707647	1 x 185	-	26,0	544,0	1020,0
706578	1 x 240	-	30,3	706,0	1250,0

Part no.	No. cores x cross-sec. mm ²	AWG-No.	Outer Ø app. mm	AL weight kg / km	Weight app. kg / km
707432	1 x 300	-	33,2	882,0	1520,0
707648	1 x 400	-	37,4	1176,0	1855,0

Dimensions and specifications may be changed without prior notice.

HELWIND® WK POWERLINE ALU robust

1,8/3 kV, flexible ALU-Conductor



Technical data

- **Temperature range**
flexing -20°C to +90°C
fixed installation -40°C to +105°C
- Permissible conductor **operating temperature** +105°C up to 3000h
- **Nominal voltage**
1,8/3 kV
- **Test voltage**
9 kV
- **Minimum bending radius**
flexing 10x cable Ø
fixed installation 4x cable Ø
- **Flame test**
IEC 60332-1-2
- **Approvals**
in accordance DIN VDE 0250-813

Cable structure

- Aluminium conductor, fine stranded wires
- Special insulation black
- Sheath: special compound
- Sheath colour: black

Properties

- Extremely abrasion resistant
- UV resistant
- Oil resistant
- Easy to assemble
- Recyclable

Note

For more information, especially on custom cables and connectivity solutions, please contact us: wind@helukabel.de

Application

The HELWIND® WK POWERLINE ALU robust is a highly flexible, aluminium cable with a finely stranded structure and is designed for use in the power engineering sector, specifically for power cabling in industrial applications. Thanks to its high level of flexibility and reduced weight, this cable is an interesting option compared to fine-stranded copper cables in many applications.

The HELWIND® WK POWERLINE ALU series unlocks its full potential, when it comes to power wiring of wind power plants. Due to its low weight, cables can be fed through the tower in one length. This eliminates the need for the time-consuming cabling of individual tower segments. However, the key benefit is an increased reliability of the connection technology: The number of interruptions between the topmost tower segment and the converter can be reduced from 90 connection points to just 18 (depending on the number of power cables and tower segments). As a result, the amount of time required for installation can drop from several days, to a few hours. For torsion applications, we recommend the HELWIND® WK 103-Torsion, WK 135-Torsion or WK 137-Torsion.

The HELWIND® WK POWERLINE ALU may only be used with certified connection technology from HELUKABEL®. This includes C8 crimp connections and screwed connections; both described in the "Connection Technology" section and tested in accordance with IEC 61238-1 Cl. A.

The cable is also available in a halogen-free design, with UL/CSA approval, and a rated voltage of 0,6/1 kV. The "robust" version features a high abrasion and mechanical load resistant PUR sheath.

☑️ = Product conforms with Low-Voltage Directive 2014/35/EU.

Part no.	No. cores x cross-sec. mm ²	AWG-No.	Outer Ø app. mm	AL weight kg / km	Weight app. kg / km
707692	1 x 185	-	26,0	544,0	1020,0
707693	1 x 240	-	28,4	706,0	1250,0

Part no.	No. cores x cross-sec. mm ²	AWG-No.	Outer Ø app. mm	AL weight kg / km	Weight app. kg / km
707694	1 x 300	-	33,2	882,0	1520,0
707695	1 x 400	-	38,1	1176,0	1855,0

Dimensions and specifications may be changed without prior notice.

HELUWIND® WK POWERLINE ALU halogen-free

1,8/3 kV, flexible ALU-Conductor



Technical data

- **Temperature range**
flexing -20°C to +90°C
fixed installation -40°C to +105°C
- Permissible conductor **operating temperature** +105°C up to 3000h
- **Nominal voltage**
1,8/3 kV
- **Test voltage**
9 kV
- **Minimum bending radius**
flexing 10x cable Ø
fixed installation 4x cable Ø
- **Approvals**
in accordance DIN VDE 0250-813

Cable structure

- Aluminium conductor, fine stranded wires
- Special insulation black
- Sheath: special compound
- Sheath colour: black

Properties

- Halogen-free
- Abrasion resistant
- UV resistant
- Oil resistant
- Easy to assemble
- Recyclable

Note

For more information, especially on custom cables and connectivity solutions, please contact us: wind@helukabel.de

Application

The HELUWIND® WK POWERLINE ALU halogen-free is a highly flexible, aluminium cable with a finely stranded structure and is designed for use in the power engineering sector, specifically for power cabling in industrial applications. Thanks to its high level of flexibility and reduced weight, this cable is an interesting option compared to fine-stranded copper cables in many applications.

The HELUWIND® WK POWERLINE ALU series unlocks its full potential, when it comes to power wiring of wind power plants. Due to its low weight, cables can be fed through the tower in one length. This eliminates the need for the time-consuming cabling of individual tower segments. However, the key benefit is an increased reliability of the connection technology: The number of interruptions between the topmost tower segment and the converter can be reduced from 90 connection points to just 18 (depending on the number of power cables and tower segments). As a result, the amount

of time required for installation can drop from several days, to a few hours. For torsion applications, we recommend the HELUWIND® WK 103-Torsion, WK 135-Torsion or WK 137-Torsion.

The HELUWIND® WK POWERLINE ALU may only be used with certified connection technology from HELUKABEL®. This includes C8 crimp connections and screwed connections; both described in the "Connection Technology" section and tested in accordance with IEC 61238-1 cl. A.

The cable is also available with UL/CSA approval.

☑ = Product conforms with Low-Voltage Directive 2014/35/EU.

Part no.	No. cores x cross-sec. mm ²	AWG-No.	Outer Ø app. mm	AL weight kg / km	Weight app. kg / km
709143	1 x 185	-	26,0	544,0	1020,0
709144	1 x 240	-	28,4	706,0	1150,0

Part no.	No. cores x cross-sec. mm ²	AWG-No.	Outer Ø app. mm	AL weight kg / km	Weight app. kg / km
709145	1 x 300	-	33,2	882,0	1400,0
709146	1 x 400	-	38,1	1176,0	1680,0

Dimensions and specifications may be changed without prior notice.

HELUWIND® WK RHH/RHW-2 ALU

UL listed as types RHW/RHW-2. RW90/R90, FT4 per CSA



Technical data

- **Temperature range**
flexing -40°C to +90°C (wet & dry)
- **Nominal voltage**
2000 V
- **Approvals**
UL 44 for Thermoset-Insulated Wires and Cables
ICEA S-95-658 / NEMA WC70 for Non-shielded 0-2 kV Cables
All cross sections are rated VW1 (fire protection classification)

Cable structure

- **Conductor:**
 - Aluminium AA-8000 alloy compacted conductor
 - Class B stranding, per ASTM B801
 - Sizes: 6 AWG - 1000 kcmil
- **Insulation:**
 - Flame retardant thermoset ethylene propylene rubber (EPR) compound
- **Sheath:**
 - Black flame retardant thermoset chlorinated polyethylene (CPE) compound

Properties

- Sheath is rated Oil Resistance I or II per UL 44
- Rated Sun Resistance for CT use, 1/0 AWG and larger

Note

- **RHH/RHW-2 600 V on request** For more information, especially on custom cables and connectivity solutions, please contact us: wind@helukabel.de

Application

For power, lighting, signal and control circuits installed in wet or dry locations. In conduit, duct, tray, and open air, and aerial installations. Suitable for use in industrial areas, fixed installation in wind turbines and utility systems where flame resistance is essential.

Part no.	Cross-section AWG / kcmil	Outer Ø app. mm	Weight app. kg / km	Outer Ø app. inch	Weight app. lb / kft
708746	6	8,9	0,0	0,35	71,0
708747	4	9,9	0,0	0,39	91,0
708748	2	11,4	0,0	0,45	124,0
708749	1	13,7	0,0	0,54	174,0
708750	1/0	14,5	0,0	0,57	202,0
708751	2/0	15,5	0,0	0,61	238,0
708752	3/0	16,8	0,0	0,66	281,0
708753	4/0	18,0	0,0	0,71	335,0

Part no.	Cross-section AWG / kcmil	Outer Ø app. mm	Weight app. kg / km	Outer Ø app. inch	Weight app. lb / kft
708754	250 kcmil	20,8	0,0	0,82	429,0
712222	300 kcmil	22,1	0,0	0,87	491,0
712223	350 kcmil	23,4	0,0	0,92	552,0
712224	400 kcmil	24,4	0,0	0,96	612,0
712225	500 kcmil	26,4	0,0	1,04	729,0
712226	600 kcmil	29,2	0,0	1,15	878,0
712227	750 kcmil	31,5	0,0	1,24	1052,0
712228	1000 kcmil	35,2	0,0	0,00	1338,0

Dimensions and specifications may be changed without prior notice.



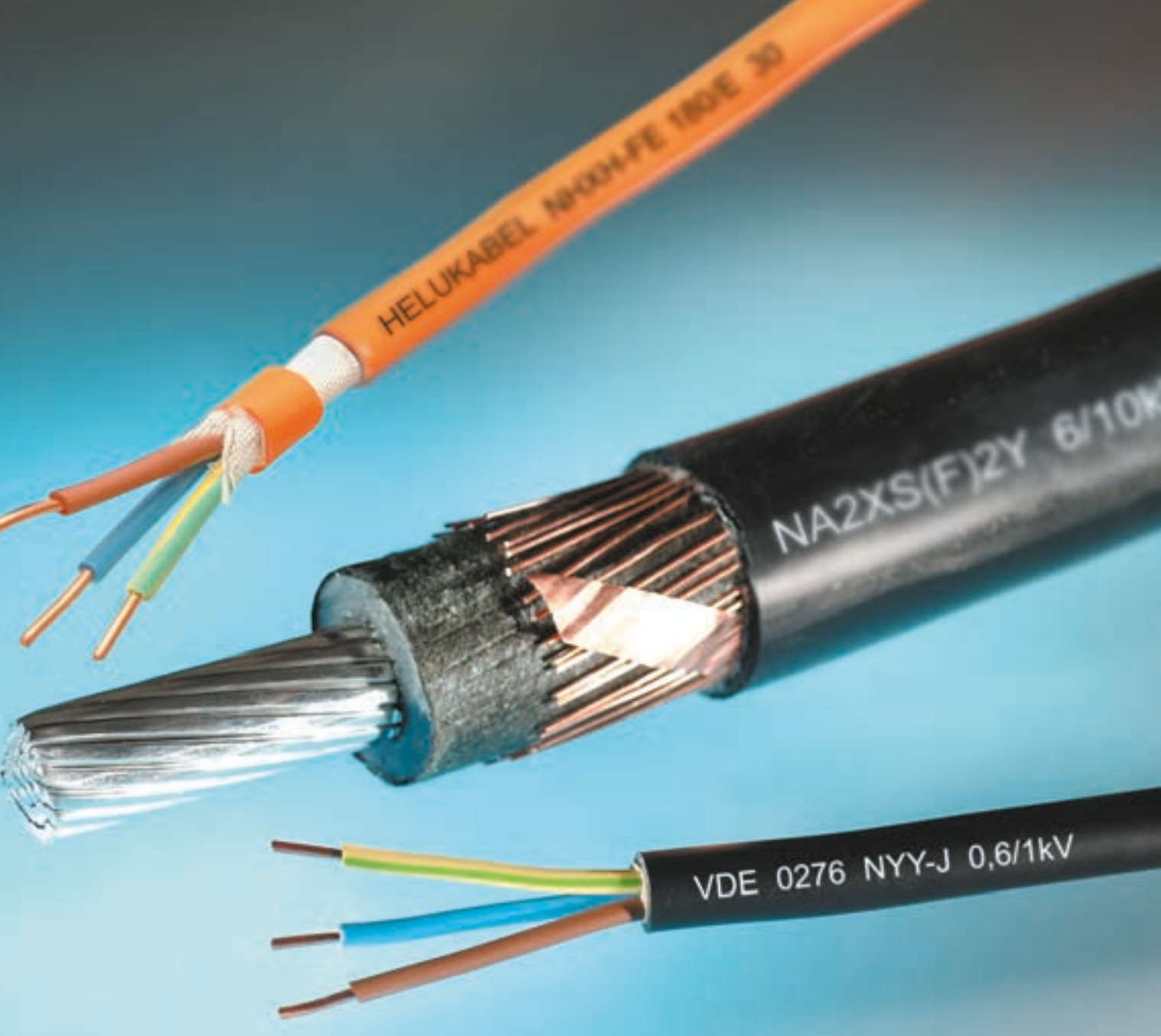

N2XS2Y 6/10kV, 12/20kV, 18/30kV

HELUWIND® WK POWERLINE MS single

NA2XS2Y 6/10kV, 12/20kV, 18/30kV

N2XS(F)2Y 6/10kV, 12/20kV, 18/30kV

■ INFRASTRUCTURE CABLES

Designation	Page
N2XSY 6/10kV, 12/20kV, 18/30kV	84
N2XS2Y 6/10kV, 12/20kV, 18/30kV	86
N2XS(F)2Y 6/10kV, 12/20kV, 18/30kV	88
N2XS(FL)2Y 6/10kV, 12/20kV, 18/30kV	90
NA2XSY 6/10kV, 12/20kV, 18/30kV	92
NA2XS2Y 6/10kV, 12/20kV, 18/30kV	94
NA2XS(F)2Y 6/10kV, 12/20kV, 18/30kV	96
NA2XS(FL)2Y 6/10kV, 12/20kV, 18/30kV	98
HELUWIND® VVK POWERLINE ALU MS single	100
MV-90/MV-105 ALUMINIUM/COPPER UL listed	101

N2XSY 6/10 kV, 12/20 kV, 18/30 kV

XLPE-insulated, Cu-conductor, single core, screened, PVC-sheath



Technical data

- XLPE-insulated power cables acc. to DIN VDE 0276 part 620, HD 620 S2 and IEC 60502
- **Temperature range** during installation up to -5°C
- **Operating temperature** max. +90°C
- **Short circuit temperature** +250°C (short circuit duration max. 5 s)
- **Nominal voltage** U₀/U 6/10 kV, 12/20 kV, 18/30 kV
- **Operating voltage, 50 Hz** for 6/10 kV = max. 12 kV for 12/20 kV = max. 24 kV for 18/30 kV = max. 36 kV
- **Test voltage** for 6/10 kV = 21 kV for 12/20 kV = 42 kV for 18/30 kV = 63 kV
- **Minimum bending radius** 15x cable Ø
- **Power ratings table** see "Technical Informations"

Cable structure

- Bare copper conductor, to DIN VDE 0295 cl.2, multi-wire, BS 6360 cl.2, IEC 60228 cl.2
- Inner semi-conducting coating
- Core insulation of cross-linked polyethylene (XLPE), compound type DIX8 to HD 620 S2
- Outer conductive layer extruded and permanently welded to the core insulation
- Conductive wrapping
- Screen: Braiding of copper wires with one or two tapes applied helically
- Wrapping
- Outer sheath of PVC compound type DMV6 to HD 620 S2
- Sheath colour: red

Properties

- The materials used during manufacturing are cadmium-free, contain no silicone and are free from substances harmful to the wetting properties of lacquers

Tests

- Self-extinguishing and flame retardant acc. to DIN VDE 0482-332-1-2, DIN EN 60332-1-2, IEC 60332-1-2 (equivalent DIN VDE 0472 part 804 test method B)

Installation notes

- To guarantee an optimum on operating reliability the extruded semi-conductive layer is spliced with the insulation for long duration. For this reason we recommend a peeling tool for installation

Note

- rm = round conductor, multi-wire
- Further dimensions available on request.
- AWG sizes are approximate equivalent values. The actual cross section is in mm².

Application

Suitable for installation mostly for power supply stations, in indoors and in cable ducts, outdoor with protected laying, underground and in water as well as for installation on cable trays for industries, switch-boards and power stations. Due to the good laying characteristic, this can also be laid easily in difficult line guideways. The inner conducting layer between the conductor and the XLPE insulation and the firmly bonded outer conducting layer on the XLPE insulation assures a construction free of partial discharges with high operational reliability.

Part no.	No. cores x cross-sec. mm ²	Operation voltage max.	Nominal voltage kV	Insulation thickness mm	Sheath thickness Nominal value mm	Outer Ø min. - max. mm	Cop. weight kg / km	Weight app. kg / km	AWG-No.
32400	1 x 35 rm / 16	12	6 / 10	3,4	2,5	23,0 - 28,0	518,0	905,0	2
32401	1 x 50 rm / 16	12	6 / 10	3,4	2,5	24,0 - 29,0	662,0	1080,0	1
32402	1 x 70 rm / 16	12	6 / 10	3,4	2,5	26,0 - 31,0	854,0	1310,0	2/0
32403	1 x 95 rm / 16	12	6 / 10	3,4	2,5	26,0 - 32,0	1094,0	1580,0	3/0
32404	1 x 120 rm / 16	12	6 / 10	3,4	2,5	28,0 - 34,0	1334,0	1860,0	4/0
32405	1 x 150 rm / 16	12	6 / 10	3,4	2,5	29,0 - 35,0	1622,0	2040,0	300 kcmil
32406	1 x 150 rm / 25	12	6 / 10	3,4	2,5	29,0 - 35,0	1723,0	2210,0	300 kcmil
32407	1 x 185 rm / 16	12	6 / 10	3,4	2,5	31,0 - 37,0	1958,0	2450,0	350 kcmil
32408	1 x 185 rm / 25	12	6 / 10	3,4	2,5	31,0 - 37,0	2059,0	2580,0	350 kcmil
32409	1 x 240 rm / 16	12	6 / 10	3,4	2,5	33,0 - 39,0	2486,0	3000,0	500 kcmil
32410	1 x 240 rm / 25	12	6 / 10	3,4	2,5	33,0 - 39,0	2587,0	3130,0	500 kcmil
32411	1 x 300 rm / 25	12	6 / 10	3,4	2,5	36,0 - 41,0	3163,0	3780,0	600 kcmil
32412	1 x 400 rm / 35	12	6 / 10	3,4	2,5	40,0 - 45,0	4234,0	4670,0	750 kcmil
32413	1 x 500 rm / 35	12	6 / 10	3,4	2,5	43,0 - 48,0	5194,0	5750,0	1000 kcmil
33099	1 x 630 rm / 35	12	6 / 10	3,4	2,5	44,0 - 49,0	6442,0	7180,0	1250 kcmil
32414	1 x 35 rm / 16	24	12 / 20	5,5	2,5	27,0 - 32,0	518,0	1110,0	2
32415	1 x 50 rm / 16	24	12 / 20	5,5	2,5	28,0 - 33,0	662,0	1250,0	1
32416	1 x 70 rm / 16	24	12 / 20	5,5	2,5	30,0 - 35,0	854,0	1510,0	2/0
32417	1 x 95 rm / 16	24	12 / 20	5,5	2,5	31,0 - 36,0	1094,0	1780,0	3/0
32418	1 x 120 rm / 16	24	12 / 20	5,5	2,5	32,0 - 38,0	1334,0	2070,0	4/0
32419	1 x 150 rm / 16	24	12 / 20	5,5	2,5	33,0 - 39,0	1622,0	2310,0	300 kcmil
32420	1 x 150 rm / 25	24	12 / 20	5,5	2,5	33,0 - 39,0	1723,0	2420,0	300 kcmil
32421	1 x 185 rm / 16	24	12 / 20	5,5	2,5	35,0 - 41,0	1958,0	2650,0	350 kcmil
32422	1 x 185 rm / 25	24	12 / 20	5,5	2,5	35,0 - 41,0	2059,0	2810,0	350 kcmil
32423	1 x 240 rm / 16	24	12 / 20	5,5	2,5	38,0 - 44,0	2486,0	3260,0	500 kcmil
32424	1 x 240 rm / 25	24	12 / 20	5,5	2,5	38,0 - 44,0	2587,0	3360,0	500 kcmil
32425	1 x 300 rm / 25	24	12 / 20	5,5	2,5	40,0 - 46,0	3163,0	4020,0	600 kcmil
32426	1 x 400 rm / 35	24	12 / 20	5,5	2,5	43,0 - 49,0	4234,0	4930,0	750 kcmil
32427	1 x 500 rm / 35	24	12 / 20	5,5	2,5	46,0 - 52,0	5194,0	6050,0	1000 kcmil
33096	1 x 630 rm / 35	24	12 / 20	5,5	2,5	47,0 - 53,0	6442,0	7510,0	1250 kcmil

Continuation ▶

N2XSy 6/10 kV, 12/20 kV, 18/30 kV

XLPE-insulated, Cu-conductor, single core, screened, PVC-sheath



Part no.	No. cores x cross-sec. mm ²	Operation voltage max.	Nominal voltage kV	Insulation thickness mm	Sheath thickness Nominal value mm	Outer Ø min. - max. mm	Cop. weight kg / km	Weight app. kg / km	AWG-No.
32428	1 x 50 rm / 16	36	18 / 30	8	2,5	32,0 - 38,0	662,0	1480,0	1
32429	1 x 70 rm / 16	36	18 / 30	8	2,5	34,0 - 40,0	854,0	1730,0	2/0
32430	1 x 95 rm / 16	36	18 / 30	8	2,5	35,0 - 41,0	1094,0	2060,0	3/0
32431	1 x 120 rm / 16	36	18 / 30	8	2,5	37,0 - 43,0	1334,0	2330,0	4/0
32432	1 x 150 rm / 25	36	18 / 30	8	2,5	38,0 - 44,0	1723,0	2720,0	300 kcmil
32433	1 x 185 rm / 25	36	18 / 30	8	2,5	40,0 - 46,0	2059,0	3100,0	350 kcmil
32434	1 x 240 rm / 25	36	18 / 30	8	2,5	42,0 - 48,0	2587,0	3730,0	500 kcmil
32435	1 x 300 rm / 25	36	18 / 30	8	2,5	45,0 - 51,0	3163,0	4000,0	600 kcmil
32436	1 x 400 rm / 35	36	18 / 30	8	2,5	48,0 - 54,0	4234,0	5330,0	750 kcmil
32437	1 x 500 rm / 35	36	18 / 30	8	2,5	51,0 - 57,0	5194,0	6480,0	1000 kcmil
33098	1 x 630 rm / 35	36	18 / 30	8	2,5	52,0 - 59,0	6442,0	7970,0	1250 kcmil

Dimensions and specifications may be changed without prior notice. (RQ03)

N2XS2Y 6/10 kV, 12/20 kV, 18/30 kV

XLPE-insulated, Cu-conductor, single core, screened, PE-sheath



Technical data

- XLPE-insulated power cables acc.to DIN VDE 0276 part 620, HD 620 S2 and IEC 60502
- **Temperature range** during installation up to -20°C
- **Operating temperature** max. +90°C
- **Short circuit temperature** +250°C (short circuit duration max. 5 s)
- **Nominal voltage** U₀/U 6/10 kV, 12/20 kV, 18/30 kV
- **Operating voltage, 50 Hz** for 6/10 kV = max. 12 kV for 12/20 kV = max. 24 kV for 18/30 kV = max. 36 kV
- **Test voltage** for 6/10 kV = 21 kV for 12/20 kV = 42 kV for 18/30 kV = 63 kV
- **Minimum bending radius** 15x cable Ø
- **Power rating** see "Technical Informations"

Cable structure

- Bare copper conductor, to DIN VDE 0295 cl.2, multi-wire, BS 6360 cl.2, IEC 60228 cl.2
- Inner semi-conducting coating
- Core insulation of cross-linked polyethylene (XLPE), compound type DIX8 to HD 620 S2
- Outer conductive layer extruded and permanently welded with the core insulation
- Conductive wrapping
- Screen: Braiding of copper wires with one or two tapes applied helically
- Wrapping
- Outer sheath of PE compound type DMP2 to HD 620 S2
- Sheath colour: black

Properties

- The materials used during manufacturing are cadmium-free, contain no silicone and are free from substances harmful to the wetting properties of lacquers
- **Installation notes** To guarantee an optimum on operating reliability the extruded semi-conductive layer is spliced with the insulation for long duration. For this reason we recommend a peeling tool for installation

Note

- rm = round conductor, multi-wire
- Further dimensions available on request.
- AWG sizes are approximate equivalent values. The actual cross section is in mm².

Application

Suitable for indoor installation and in cable ducts, outdoors, underground and in water as well as for installation on cable trays for industries, switch-boards and power stations. The PE-outer sheath is resistant to high mechanical stress for laying the cables. This PE-sheath is not flame retardant acc. to DIN EN 60332-1-2. The inner conducting layer between the conductor and the XLPE insulation and the firmly bonded outer conducting layer on the XLPE insulation assures a construction free of partial discharges with high operational reliability.

Part no.	No. cores x cross-sec. mm ²	Operation voltage max.	Nominal voltage kV	Insulation thickness mm	Sheath thickness Nominal value mm	Outer Ø min. - max. mm	Cop. weight kg / km	Weight app. kg / km	AWG-No.
32480	1 x 35 rm / 16	12	6 / 10	3,4	2,5	23,0 - 28,0	518,0	910,0	2
32481	1 x 50 rm / 16	12	6 / 10	3,4	2,5	24,0 - 29,0	662,0	990,0	1
32482	1 x 70 rm / 16	12	6 / 10	3,4	2,5	26,0 - 31,0	854,0	1205,0	2/0
32483	1 x 95 rm / 16	12	6 / 10	3,4	2,5	26,0 - 32,0	1098,0	1520,0	3/0
32484	1 x 120 rm / 16	12	6 / 10	3,4	2,5	28,0 - 34,0	1334,0	1760,0	4/0
32485	1 x 150 rm / 16	12	6 / 10	3,4	2,5	29,0 - 35,0	1622,0	2020,0	300 kcmil
32486	1 x 150 rm / 25	12	6 / 10	3,4	2,5	29,0 - 35,0	1725,0	2130,0	300 kcmil
32487	1 x 185 rm / 16	12	6 / 10	3,4	2,5	31,0 - 37,0	1958,0	2360,0	350 kcmil
32488	1 x 185 rm / 25	12	6 / 10	3,4	2,5	31,0 - 37,0	2059,0	2470,0	350 kcmil
32489	1 x 240 rm / 16	12	6 / 10	3,4	2,5	33,0 - 39,0	2486,0	2960,0	500 kcmil
32490	1 x 240 rm / 25	12	6 / 10	3,4	2,5	33,0 - 39,0	2587,0	3020,0	500 kcmil
32491	1 x 300 rm / 25	12	6 / 10	3,4	2,5	36,0 - 41,0	3163,0	3630,0	600 kcmil
32492	1 x 400 rm / 35	12	6 / 10	3,4	2,5	40,0 - 45,0	4234,0	4560,0	750 kcmil
32493	1 x 500 rm / 35	12	6 / 10	3,4	2,5	43,0 - 48,0	5194,0	5580,0	1000 kcmil
32494	1 x 35 rm / 16	24	12 / 20	5,5	2,5	27,0 - 32,0	518,0	960,0	2
32495	1 x 50 rm / 16	24	12 / 20	5,5	2,5	28,0 - 33,0	662,0	1160,0	1
32496	1 x 70 rm / 16	24	12 / 20	5,5	2,5	30,0 - 35,0	854,0	1410,0	2/0
32497	1 x 95 rm / 16	24	12 / 20	5,5	2,5	31,0 - 36,0	1094,0	1670,0	3/0
32498	1 x 120 rm / 16	24	12 / 20	5,5	2,5	33,0 - 38,0	1334,0	1960,0	4/0
32499	1 x 150 rm / 16	24	12 / 20	5,5	2,5	34,0 - 39,0	1622,0	2220,0	300 kcmil
32500	1 x 150 rm / 25	24	12 / 20	5,5	2,5	34,0 - 39,0	1723,0	2310,0	300 kcmil
32501	1 x 185 rm / 16	24	12 / 20	5,5	2,5	36,0 - 41,0	1958,0	2620,0	350 kcmil
32502	1 x 185 rm / 25	24	12 / 20	5,5	2,5	36,0 - 41,0	2059,0	2670,0	350 kcmil
32503	1 x 240 rm / 16	24	12 / 20	5,5	2,5	39,0 - 44,0	2486,0	3160,0	500 kcmil
32504	1 x 240 rm / 25	24	12 / 20	5,5	2,5	39,0 - 44,0	2587,0	3270,0	500 kcmil
32505	1 x 300 rm / 25	24	12 / 20	5,5	2,5	41,0 - 46,0	3163,0	3880,0	600 kcmil
32506	1 x 400 rm / 35	24	12 / 20	5,5	2,5	44,0 - 49,0	4234,0	4820,0	750 kcmil
32507	1 x 500 rm / 35	24	12 / 20	5,5	2,5	47,0 - 52,0	5194,0	5860,0	1000 kcmil

Continuation ▶

N2XS2Y 6/10 kV, 12/20 kV, 18/30 kV

XLPE-insulated, Cu-conductor, single core, screened, PE-sheath



Part no.	No. cores x cross-sec. mm ²	Operation voltage max.	Nominal voltage kV	Insulation thickness mm	Sheath thickness Nominal value mm	Outer Ø min. - max. mm	Cop. weight kg / km	Weight app. kg / km	AWG-No.
32508	1 x 50 rm / 16	36	18 / 30	8	2,5	32,0 - 38,0	662,0	1410,0	1
32509	1 x 70 rm / 16	36	18 / 30	8	2,5	34,0 - 40,0	854,0	1660,0	2/0
32510	1 x 95 rm / 16	36	18 / 30	8	2,5	35,0 - 41,0	1094,0	1970,0	3/0
32511	1 x 120 rm / 16	36	18 / 30	8	2,5	37,0 - 43,0	1334,0	2220,0	4/0
32512	1 x 150 rm / 25	36	18 / 30	8	2,5	38,0 - 44,0	1723,0	2650,0	300 kcmil
32513	1 x 185 rm / 25	36	18 / 30	8	2,5	40,0 - 46,0	2059,0	2980,0	350 kcmil
32514	1 x 240 rm / 25	36	18 / 30	8	2,5	42,0 - 48,0	2587,0	3570,0	500 kcmil
32515	1 x 300 rm / 25	36	18 / 30	8	2,5	45,0 - 51,0	3163,0	4220,0	600 kcmil
32516	1 x 400 rm / 35	36	18 / 30	8	2,5	48,0 - 54,0	4234,0	5170,0	750 kcmil
32517	1 x 500 rm / 35	36	18 / 30	8	2,5	51,0 - 57,0	5194,0	6260,0	1000 kcmil

Dimensions and specifications may be changed without prior notice. (RQ03)

N2XS(F)2Y 6/10 kV, 12/20 kV, 18/30 kV

XLPE-insulated, Cu-conductor, single core, longitudinally watertight, screened, PE-sheath



Technical data

- XLPE-insulated power cables acc. to DIN VDE 0276 part 620, HD 620 S2 and IEC 60502
- **Temperature range**
during installation up to -20°C
- **Operating temperature**
max. +90°C
- **Short circuit temperature**
+250°C (short circuit duration max. 5 s)
- **Nominal voltage**
U₀/U 6/10 kV, 12/20 kV, 18/30 kV
- **Operating voltage, 50 Hz**
for 6/10 kV = max. 12 kV
for 12/20 kV = max. 24 kV
for 18/30 kV = max. 36 kV
- **Test voltage**
for 6/10 kV = 21 kV
for 12/20 kV = 42 kV
for 18/30 kV = 63 kV
- **Minimum bending radius**
15x cable Ø
- **Power rating**
see "Technical Informations"

Cable structure

- Bare copper conductor, to DIN VDE 0295 cl.2, multi-wire, BS 6360 cl.2, IEC 60228 cl.2
- Inner semi-conducting coating
- Core insulation of cross-linked polyethylene (XLPE), compound type DIX8 to HD 620 S2
- Outer conductive layer extruded and permanently welded with the core insulation
- Longitudinally watertight, conductive wrapping
- Screen: Braiding of copper wires with one or two tapes applied helically
- Longitudinally water-tight wrapping
- Outer sheath of PE compound type DMP2 to HD 620 S2
- Sheath colour: black

Properties

- The materials used during manufacturing are cadmium-free, contain no silicone and are free from substances harmful to the wetting properties of lacquers
- **Installation notes**
To guarantee an optimum on operating reliability the extruded semi-conductive layer is spliced with the insulation for long duration. For this reason we recommend a peeling tool for installation

Note

- rm = round conductor, multi-wire
- Further types and dimensions on request.
- AWG sizes are approximate equivalent values. The actual cross section is in mm².

Application

Suitable for indoor installation and in cable ducts, outdoors, underground and in water as well as for installation on cable trays for industries, switch-boards and power stations. The PE-outer sheath is resistant to high mechanical stress for laying the cables. This PE sheath is not flame retardant acc. to DIN EN 60332-1-2. The inner conducting layer between the conductor and the XLPE insulation and the firmly bonded outer conducting layer on the XLPE insulation assures a construction free of partial discharges with high operational reliability.

Part no.	No. cores x cross-sec. mm ²	Operation voltage max.	Nominal voltage kV	Insulation thickness mm	Screen cross-sec. mm ²	Sheath thickness Nominal value mm	Outer Ø app. mm	Cop. weight kg / km	Weight app. kg / km	AWG-No.
32560	1 x 35 rm / 16	12	6 / 10	3,4	16	2,5	26,0	518,0	1050,0	2
32561	1 x 50 rm / 16	12	6 / 10	3,4	16	2,5	28,0	662,0	1150,0	1
32562	1 x 70 rm / 16	12	6 / 10	3,4	16	2,5	30,0	854,0	1460,0	2/0
32563	1 x 95 rm / 16	12	6 / 10	3,4	16	2,5	31,0	1094,0	1700,0	3/0
32564	1 x 120 rm / 16	12	6 / 10	3,4	16	2,5	32,0	1334,0	2030,0	4/0
32565	1 x 150 rm / 25	12	6 / 10	3,4	25	2,5	34,0	1723,0	2350,0	300 kcmil
32566	1 x 185 rm / 25	12	6 / 10	3,4	25	2,5	36,0	2059,0	2700,0	350 kcmil
32567	1 x 240 rm / 25	12	6 / 10	3,4	25	2,5	38,0	2587,0	3300,0	500 kcmil
32568	1 x 300 rm / 25	12	6 / 10	3,4	25	2,5	40,0	3163,0	3900,0	600 kcmil
32569	1 x 400 rm / 35	12	6 / 10	3,4	35	2,5	44,0	4234,0	4850,0	750 kcmil
32570	1 x 500 rm / 35	12	6 / 10	3,4	35	2,5	47,0	5194,0	6000,0	1000 kcmil
79954	1 x 630 rm / 35	12	6 / 10	3,4	35	2,5	49,0	6442,0	7020,0	1250 kcmil
32571	1 x 35 rm / 16	24	12 / 20	5,5	16	2,5	31,0	518,0	1210,0	2
32572	1 x 50 rm / 16	24	12 / 20	5,5	16	2,5	33,0	662,0	1400,0	1
32573	1 x 70 rm / 16	24	12 / 20	5,5	16	2,5	34,0	854,0	1550,0	2/0
32574	1 x 95 rm / 16	24	12 / 20	5,5	16	2,5	36,0	1094,0	1800,0	3/0
32575	1 x 120 rm / 16	24	12 / 20	5,5	16	2,5	37,0	1334,0	2150,0	4/0
32576	1 x 150 rm / 25	24	12 / 20	5,5	25	2,5	39,0	1723,0	2400,0	300 kcmil
32577	1 x 185 rm / 25	24	12 / 20	5,5	25	2,5	41,0	2059,0	2850,0	350 kcmil
32578	1 x 240 rm / 25	24	12 / 20	5,5	25	2,5	43,0	2587,0	3250,0	500 kcmil
32579	1 x 300 rm / 25	24	12 / 20	5,5	25	2,5	45,0	3163,0	3850,0	600 kcmil
32580	1 x 400 rm / 35	24	12 / 20	5,5	35	2,5	48,0	4234,0	4900,0	750 kcmil
32581	1 x 500 rm / 35	24	12 / 20	5,5	35	2,5	52,0	5194,0	6100,0	1000 kcmil
33092	1 x 630 rm / 35	24	12 / 20	5,5	35	2,5	54,0	6442,0	7340,0	1250 kcmil

Continuation ▶

N2XS(F)2Y 6/10 kV, 12/20 kV, 18/30 kV

XLPE-insulated, Cu-conductor, single core, longitudinally watertight, screened, PE-sheath



Part no.	No. cores x cross-sec. mm ²	Operation voltage max.	Nominal voltage kV	Insulation thickness mm	Screen cross-sec. mm ²	Sheath thickness Nominal value mm	Outer Ø app. mm	Cop. weight kg / km	Weight app. kg / km	AWG-No.
32582	1 x 50 rm / 16	36	18 / 30	8	16	2,5	37,0	662,0	1700,0	1
32583	1 x 70 rm / 16	36	18 / 30	8	16	2,5	38,0	854,0	1950,0	2/0
32584	1 x 95 rm / 16	36	18 / 30	8	16	2,5	40,0	1094,0	2300,0	3/0
32585	1 x 120 rm / 16	36	18 / 30	8	16	2,5	42,0	1334,0	2600,0	4/0
32586	1 x 150 rm / 25	36	18 / 30	8	25	2,5	43,0	1723,0	3000,0	300 kcmil
32587	1 x 185 rm / 25	36	18 / 30	8	25	2,5	45,0	2059,0	3350,0	350 kcmil
32588	1 x 240 rm / 25	36	18 / 30	8	25	2,5	47,0	2587,0	4100,0	500 kcmil
32589	1 x 300 rm / 25	36	18 / 30	8	25	2,5	50,0	3163,0	4800,0	600 kcmil
32590	1 x 400 rm / 35	36	18 / 30	8	35	2,5	53,0	4234,0	5750,0	750 kcmil
32591	1 x 500 rm / 35	36	18 / 30	8	35	2,5	56,0	5194,0	6700,0	1000 kcmil
708487	1 x 630 rm / 35	36	18 / 30	8	35	2,5	59,0	6442,0	7760,0	1250 kcmil

Dimensions and specifications may be changed without prior notice. (RQ03)

N2XS(FL)2Y 6/ 10 kV, 12/20 kV, 18/30 kV

XLPE-insulated, Cu-conductor, single core, screened, longitudinally and crosswise watertight, PE-sheath



Technical data

- XLPE-insulated power cables acc. to DIN VDE 0276 part 620, HD 620 S2 and IEC 60502
- **Temperature range**
during installation up to -20°C
- **Operating temperature**
max. +90°C
- **Short circuit temperature**
+250°C (short circuit duration max. 5 s)
- **Nominal voltage**
U₀/U 6/10 kV, 12/20 kV, 18/30 kV
- **Operating voltage, 50 Hz**
for 6/10 kV = max. 12 kV
for 12/20 kV = max. 24 kV
for 18/30 kV = max. 36 kV
- **Test voltage**
for 6/10 kV = 21 kV
for 12/20 kV = 42 kV
for 18/30 kV = 63 kV
- **Minimum bending radius**
15x cable Ø
- **Power ratings**
see "Technical Informations"

Cable structure

- Bare copper conductor, to DIN VDE 0295 cl.2, multi-wire, BS 6360 cl.2, IEC 60228 cl.2
- Inner semi-conducting coating
- Core insulation of cross-linked polyethylene (XLPE), compound type DIX8 to HD 620 S2
- Outer conductive layer extruded and permanently welded with the core insulation
- Longitudinally watertight, conductive wrapping
- Screen: Braiding of copper wires with one or two tapes applied helically
- Longitudinally watertight wrapping
- Aluminium tape spliced with PE sheath
- Outer sheath of PE compound type DMP2 to HD 620 S2
- Sheath colour: black

Properties

- The materials used during manufacturing are cadmium-free, contain no silicone and are free from substances harmful to the wetting properties of lacquers
- **Installation notes**
To guarantee an optimum on operating reliability the extruded semi-conductive layer is spliced with the insulation for long duration. For this reason we recommend a peeling tool for installation

Note

- rm = round conductor, multi-wire
- Further types and dimensions on request.
- AWG sizes are approximate equivalent values. The actual cross section is in mm².

Application

Installation primarily for power utility grids and in cable ducts, outdoors, underground and in water, and also on pallets for manufacturing plants, switchgear and power stations. The resistant Al/PE-laminated sheathing acts as a cross water barrier. It inhibits the diffusion of water. In case of sheathing damage, water impact is contained at the flaw. The cable can be severely mechanically stressed during installation and operation. The PE sheathing is not flame-retardant to DIN EN 60332-1-2. The internal conductive layer between conductor and VPE insulation and the adherent external conductive layer on the VPE insulation guarantees a design with high operational safety and no partial discharge.

Part no.	No. cores x cross-sec. mm ²	Operation voltage max.	Nominal voltage kV	Insulation thickness mm	Screen cross-sec. mm ²	Sheath thickness Nominal value mm	Outer Ø app. mm	Cop. weight kg / km	Weight app. kg / km	AWG-No.
33054	1 x 35 rm / 16	12	6 / 10	3,4	16	2,5	28,0	518,0	860,0	2
33055	1 x 50 rm / 16	12	6 / 10	3,4	16	2,5	30,0	662,0	1000,0	1
33056	1 x 70 rm / 16	12	6 / 10	3,4	16	2,5	32,0	854,0	1350,0	2/0
33057	1 x 95 rm / 16	12	6 / 10	3,4	16	2,5	33,0	1094,0	1680,0	3/0
33058	1 x 120 rm / 16	12	6 / 10	3,4	16	2,5	34,0	1334,0	2070,0	4/0
33059	1 x 150 rm / 25	12	6 / 10	3,4	25	2,5	36,0	1723,0	2350,0	300 kcmil
33060	1 x 185 rm / 25	12	6 / 10	3,4	25	2,5	38,0	2059,0	2710,0	350 kcmil
33061	1 x 240 rm / 25	12	6 / 10	3,4	25	2,5	40,0	2587,0	3260,0	500 kcmil
38049	1 x 300 rm / 25	12	6 / 10	3,4	25	2,5	42,0	3163,0	3850,0	600 kcmil
38050	1 x 400 rm / 35	12	6 / 10	3,4	35	2,5	46,0	4234,0	4740,0	750 kcmil
38051	1 x 500 rm / 35	12	6 / 10	3,4	35	2,5	49,0	5194,0	5800,0	1000 kcmil
38052	1 x 630 rm / 35	12	6 / 10	3,4	35	2,5	51,0	6442,0	7120,0	1250 kcmil
38053	1 x 35 rm / 16	24	12 / 20	5,5	16	2,5	33,0	518,0	1020,0	2
33066	1 x 50 rm / 16	24	12 / 20	5,5	16	2,5	35,0	662,0	1170,0	1
33067	1 x 70 rm / 16	24	12 / 20	5,5	16	2,5	36,0	854,0	1470,0	2/0
33083	1 x 95 rm / 16	24	12 / 20	5,5	16	2,5	38,0	1094,0	1860,0	3/0
33069	1 x 120 rm / 16	24	12 / 20	5,5	16	2,5	39,0	1334,0	2260,0	4/0
33070	1 x 150 rm / 25	24	12 / 20	5,5	25	2,5	41,0	1723,0	2550,0	300 kcmil
33071	1 x 185 rm / 25	24	12 / 20	5,5	25	2,5	43,0	2059,0	2920,0	350 kcmil
33072	1 x 240 rm / 25	24	12 / 20	5,5	25	2,5	45,0	2587,0	3490,0	500 kcmil
33073	1 x 300 rm / 25	24	12 / 20	5,5	25	2,5	47,0	3163,0	4090,0	600 kcmil
33074	1 x 400 rm / 35	24	12 / 20	5,5	35	2,5	50,0	4234,0	5010,0	750 kcmil
33075	1 x 500 rm / 35	24	12 / 20	5,5	35	2,5	54,0	5194,0	6090,0	1000 kcmil
38054	1 x 630 rm / 35	24	12 / 20	5,5	35	2,5	55,0	6442,0	7440,0	1250 kcmil

Continuation ▶

N2XS(FL)2Y 6/10 kV, 12/20 kV, 18/30 kV

XLPE-insulated, Cu-conductor, single core, screened, longitudinally and crosswise watertight, PE-sheath



Part no.	No. cores x cross-sec. mm ²	Operation voltage max.	Nominal voltage kV	Insulation thickness mm	Screen cross-sec. mm ²	Sheath thickness Nominal value mm	Outer Ø app. mm	Cop. weight kg / km	Weight app. kg / km	AWG-No.
34312	1 x 50 rm / 16	36	18 / 30	8	16	2,5	36,0	662,0	1400,0	1
38055	1 x 70 rm / 16	36	18 / 30	8	16	2,5	40,0	854,0	1710,0	2/0
38056	1 x 95 rm / 16	36	18 / 30	8	16	2,5	42,0	1094,0	2110,0	3/0
38057	1 x 120 rm / 16	36	18 / 30	8	16	2,5	44,0	1334,0	2520,0	4/0
38058	1 x 150 rm / 25	36	18 / 30	8	25	2,5	45,0	1723,0	2830,0	300 kcmil
34313	1 x 185 rm / 25	36	18 / 30	8	25	2,5	47,0	2059,0	3210,0	350 kcmil
38059	1 x 240 rm / 25	36	18 / 30	8	25	2,5	49,0	2587,0	3790,0	500 kcmil
34314	1 x 300 rm / 25	36	18 / 30	8	25	2,5	52,0	3163,0	4430,0	600 kcmil
34315	1 x 400 rm / 35	36	18 / 30	8	35	2,5	55,0	4234,0	5390,0	750 kcmil
38060	1 x 500 rm / 35	36	18 / 30	8	35	2,5	58,0	5194,0	6500,0	1000 kcmil
38061	1 x 630 rm / 35	36	18 / 30	8	35	2,5	60,0	6442,0	7870,0	1250 kcmil

Dimensions and specifications may be changed without prior notice. (RQ03)

NA2XSY 6/10 kV, 12/20 kV, 18/30 kV

XLPE-insulated, alu-conductor, single core, screened, PVC-sheath



Technical data

- XLPE-insulated power cables acc. to DIN VDE 0276 part 620, HD 620 S2 and IEC 60502
- **Temperature range** during installation up to -5°C
- **Operating temperature** max. +90°C
- **Short circuit temperature** +250°C (short circuit duration max. 5 s)
- **Nominal voltage** U₀/U 6/10 kV, 12/20 kV, 18/30 kV
- **Operating voltage, 50 Hz** for 6/10 kV = max. 12 kV for 12/20 kV = max. 24 kV for 18/30 kV = max. 36 kV
- **Test voltage** for 6/10 kV = 21 kV for 12/20 kV = 42 kV for 18/30 kV = 63 kV
- **Minimum bending radius** 15x cable Ø
- **Power rating** see "Technical Informations"

Cable structure

- Aluminium-conductor, to DIN VDE 0295 cl.2, multi-wire, BS 6360 cl.2, IEC 60228 cl.2
- Inner semi-conducting coating
- Core insulation of cross-linked polyethylene (XLPE), compound type DIX8 to HD 620 S2
- Outer conductive layer extruded and permanently welded with the core insulation
- Conductive wrapping
- Screen: Braiding of copper wires with one or two tapes applied helically
- Wrapping
- Outer sheath of PVC compound type DMV6 to HD 620 S2
- Sheath colour: red

Properties

- The materials used during manufacturing are cadmium-free, contain no silicone and are free from substances harmful to the wetting properties of lacquers

Tests

- Self-extinguishing and flame retardant acc. to DIN VDE 0482-332-1-2, DIN EN 60332-1-2, IEC 60332-1-2 (equivalent DIN VDE 0472 part 804 test method B)

Installation notes

To guarantee an optimum on operating reliability the extruded semi-conductive layer is spliced with the insulation for long duration. For this reason we recommend a peeling tool for installation

Note

- rm = round conductor, multi-wire
- Further dimensions available on request.
- AWG sizes are approximate equivalent values. The actual cross section is in mm².

Application

Suitable for installation mostly for power supply stations, in indoors and in cable ducts, outdoor with protected laying, underground and in water as well as for installation on cable trays for industries, switch-boards and power stations. Due to the good laying characteristic, this can also be laid easily in difficult line guideways.

The inner conducting layer between the conductor and the XLPE insulation and the firmly bonded outer conducting layer on the XLPE insulation assures a construction free of partial discharges with high operational reliability.

Part no.	No. cores x cross-sec. mm ²	Operation voltage max.	Nominal voltage kV	Insulation thickness mm	Sheath thickness Nominal value mm	Outer Ø min. - max. mm	Cop. weight kg / km	Alu weight kg / km	Weight app. kg / km	AWG-No.
32440	1 x 50 rm / 16	12	6 / 10	3,4	2,5	24,0 - 29,0	182,0	145,0	780,0	1
32441	1 x 70 rm / 16	12	6 / 10	3,4	2,5	26,0 - 31,0	182,0	203,0	875,0	2/0
32442	1 x 95 rm / 16	12	6 / 10	3,4	2,5	26,0 - 32,0	182,0	276,0	990,0	3/0
32443	1 x 120 rm / 16	12	6 / 10	3,4	2,5	28,0 - 34,0	182,0	348,0	1110,0	4/0
32444	1 x 150 rm / 16	12	6 / 10	3,4	2,5	29,0 - 35,0	182,0	435,0	1240,0	300 kcmil
32445	1 x 150 rm / 25	12	6 / 10	3,4	2,5	29,0 - 35,0	283,0	435,0	1310,0	300 kcmil
32446	1 x 185 rm / 16	12	6 / 10	3,4	2,5	31,0 - 37,0	182,0	537,0	1405,0	350 kcmil
32447	1 x 185 rm / 25	12	6 / 10	3,4	2,5	31,0 - 37,0	283,0	537,0	1460,0	350 kcmil
32448	1 x 240 rm / 16	12	6 / 10	3,4	2,5	33,0 - 39,0	182,0	696,0	1615,0	500 kcmil
32449	1 x 240 rm / 25	12	6 / 10	3,4	2,5	33,0 - 39,0	283,0	696,0	1660,0	500 kcmil
32450	1 x 300 rm / 25	12	6 / 10	3,4	2,5	36,0 - 41,0	283,0	870,0	1910,0	600 kcmil
32451	1 x 400 rm / 35	12	6 / 10	3,4	2,5	40,0 - 45,0	394,0	1160,0	2315,0	750 kcmil
32452	1 x 500 rm / 35	12	6 / 10	3,4	2,5	43,0 - 48,0	394,0	1450,0	2750,0	1000 kcmil
32453	1 x 50 rm / 16	24	12 / 20	5,5	2,5	28,0 - 33,0	182,0	145,0	950,0	1
32454	1 x 70 rm / 16	24	12 / 20	5,5	2,5	30,0 - 35,0	182,0	203,0	1110,0	2/0
32455	1 x 95 rm / 16	24	12 / 20	5,5	2,5	31,0 - 36,0	182,0	276,0	1220,0	3/0
32456	1 x 120 rm / 16	24	12 / 20	5,5	2,5	32,0 - 38,0	182,0	348,0	1310,0	4/0
32457	1 x 150 rm / 16	24	12 / 20	5,5	2,5	33,0 - 39,0	182,0	435,0	1460,0	300 kcmil
32458	1 x 150 rm / 25	24	12 / 20	5,5	2,5	33,0 - 39,0	283,0	435,0	1520,0	300 kcmil
32459	1 x 185 rm / 16	24	12 / 20	5,5	2,5	35,0 - 41,0	182,0	537,0	1660,0	350 kcmil
32460	1 x 185 rm / 25	24	12 / 20	5,5	2,5	35,0 - 41,0	283,0	537,0	1720,0	350 kcmil
32461	1 x 240 rm / 16	24	12 / 20	5,5	2,5	38,0 - 44,0	182,0	696,0	1860,0	500 kcmil
32462	1 x 240 rm / 25	24	12 / 20	5,5	2,5	38,0 - 44,0	283,0	696,0	1910,0	500 kcmil
32463	1 x 300 rm / 25	24	12 / 20	5,5	2,5	40,0 - 46,0	283,0	870,0	2220,0	600 kcmil
32464	1 x 400 rm / 35	24	12 / 20	5,5	2,5	43,0 - 49,0	394,0	1160,0	2620,0	750 kcmil
32465	1 x 500 rm / 35	24	12 / 20	5,5	2,5	46,0 - 52,0	394,0	1450,0	3030,0	1000 kcmil

Continuation ▶

NA2XSY 6/10 kV, 12/20 kV, 18/30 kV

XLPE-insulated, alu-conductor, single core, screened, PVC-sheath



Part no.	No. cores x cross-sec. mm ²	Operation voltage max.	Nominal voltage kV	Insulation thickness mm	Sheath thickness Nominal value mm	Outer Ø min. - max. mm	Cop. weight kg / km	Alu weight kg / km	Weight app. kg / km	AWG-No.
32466	1 x 50 rm / 16	36	18 / 30	8	2,5	32,0 - 38,0	182,0	145,0	1260,0	1
32467	1 x 70 rm / 16	36	18 / 30	8	2,5	34,0 - 40,0	182,0	203,0	1360,0	2/0
32468	1 x 95 rm / 16	36	18 / 30	8	2,5	35,0 - 41,0	182,0	276,0	1510,0	3/0
32469	1 x 120 rm / 16	36	18 / 30	8	2,5	37,0 - 43,0	182,0	348,0	1610,0	4/0
32470	1 x 150 rm / 16	36	18 / 30	8	2,5	38,0 - 44,0	182,0	435,0	1760,0	300 kcmil
32471	1 x 150 rm / 25	36	18 / 30	8	2,5	38,0 - 44,0	283,0	435,0	1810,0	300 kcmil
32472	1 x 185 rm / 16	36	18 / 30	8	2,5	40,0 - 46,0	182,0	537,0	1960,0	350 kcmil
32473	1 x 185 rm / 25	36	18 / 30	8	2,5	40,0 - 46,0	283,0	537,0	2020,0	350 kcmil
32474	1 x 240 rm / 16	36	18 / 30	8	2,5	42,0 - 48,0	182,0	696,0	2210,0	500 kcmil
32475	1 x 240 rm / 25	36	18 / 30	8	2,5	42,0 - 48,0	283,0	696,0	2260,0	500 kcmil
32476	1 x 300 rm / 25	36	18 / 30	8	2,5	45,0 - 51,0	283,0	870,0	2560,0	600 kcmil
32477	1 x 400 rm / 35	36	18 / 30	8	2,5	48,0 - 54,0	394,0	1160,0	2960,0	750 kcmil
32478	1 x 500 rm / 35	36	18 / 30	8	2,5	51,0 - 57,0	394,0	1450,0	3460,0	1000 kcmil

Dimensions and specifications may be changed without prior notice. (RQ03)

NA2XS2Y 6/10 kV, 12/20 kV, 18/30 kV

XLPE-insulated, Alu-conductor, single core, screened, PE-sheath



Technical data

- XLPE-insulated power cables acc. to DIN VDE 0276 part 620, HD 620 S2 and IEC 60502
- **Temperature range** during installation up to -20°C
- **Operating temperature** max. +90°C
- **Short circuit temperature** +250°C (short circuit duration max. 5 s)
- **Nominal voltage** U₀/U 6/10 kV, 12/20 kV, 18/30 kV
- **Operating voltage, 50 Hz** for 6/10 kV = max. 12 kV for 12/20 kV = max. 24 kV for 18/30 kV = max. 36 kV
- **Test voltage** for 6/10 kV = 21 kV for 12/20 kV = 42 kV for 18/30 kV = 63 kV
- **Minimum bending radius** 15x cable Ø
- **Power ratings** see "Technical Informations"

Cable structure

- Aluminium-conductor, to DIN VDE 0295 cl.2, multi-wire, BS 6360 cl.2, IEC 60228 cl.2
- Inner semi-conducting coating
- Core insulation of cross-linked polyethylene (XLPE), compound type DIX8 to HD 620 S2
- Outer conductive layer extruded and permanently welded with the core insulation
- Conductive wrapping
- Screen: Braiding of copper wires with one or two tapes applied helically
- Wrapping
- Outer sheath of PE compound type DMP2 to HD 620 S2
- Sheath colour: black

Properties

- The materials used during manufacturing are cadmium-free, contain no silicone and are free from substances harmful to the wetting properties of lacquers
- **Installation notes** To guarantee an optimum on operating reliability the extruded semi-conductive layer is spliced with the insulation for long duration. For this reason we recommend a peeling tool for installation

Note

- rm = round conductor, multi-wire
- Further dimensions available on request.
- AWG sizes are approximate equivalent values. The actual cross section is in mm².

Application

Suitable for indoor installation and in cable ducts, outdoors, underground and in water as well as for installation on cable trays for industries, switch-boards and power stations. The PE-outer sheath is resistant to high mechanical stress for laying the cables. This PE sheath is not flame retardant acc. to DIN EN 60332-1-2. The inner conducting layer between the conductor and the XLPE insulation and the firmly bonded outer conducting layer on the XLPE insulation assures a construction free of partial discharges with high operational reliability.

Part no.	No. cores x cross-sec. mm ²	Operation voltage max.	Nominal voltage kV	Insulation thickness mm	Sheath thickness Nominal value mm	Outer Ø min. - max. mm	Cop. weight kg / km	Alu weight kg / km	Weight app. kg / km	AWG-No.
32520	1 x 50 rm / 16	12	6 / 10	3,4	2,5	24,0 - 29,0	182,0	145,0	710,0	1
32521	1 x 70 rm / 16	12	6 / 10	3,4	2,5	26,0 - 31,0	182,0	203,0	790,0	2/0
32522	1 x 95 rm / 16	12	6 / 10	3,4	2,5	26,0 - 32,0	182,0	276,0	920,0	3/0
32523	1 x 120 rm / 16	12	6 / 10	3,4	2,5	28,0 - 34,0	182,0	348,0	990,0	4/0
32524	1 x 150 rm / 16	12	6 / 10	3,4	2,5	29,0 - 35,0	182,0	435,0	1110,0	300 kcmil
32525	1 x 150 rm / 25	12	6 / 10	3,4	2,5	29,0 - 35,0	283,0	435,0	1220,0	300 kcmil
32526	1 x 185 rm / 16	12	6 / 10	3,4	2,5	31,0 - 37,0	182,0	537,0	1260,0	350 kcmil
32527	1 x 185 rm / 25	12	6 / 10	3,4	2,5	33,0 - 39,0	283,0	537,0	1370,0	350 kcmil
32528	1 x 240 rm / 16	12	6 / 10	3,4	2,5	33,0 - 39,0	182,0	696,0	1480,0	500 kcmil
32529	1 x 240 rm / 25	12	6 / 10	3,4	2,5	33,0 - 39,0	283,0	696,0	1530,0	500 kcmil
32530	1 x 300 rm / 25	12	6 / 10	3,4	2,5	36,0 - 41,0	283,0	870,0	1820,0	600 kcmil
32531	1 x 400 rm / 35	12	6 / 10	3,4	2,5	40,0 - 45,0	394,0	1160,0	2220,0	750 kcmil
32532	1 x 500 rm / 35	12	6 / 10	3,4	2,5	43,0 - 48,0	394,0	1450,0	2570,0	1000 kcmil
32533	1 x 50 rm / 16	24	12 / 20	5,5	2,5	28,0 - 33,0	182,0	145,0	890,0	1
32534	1 x 70 rm / 16	24	12 / 20	5,5	2,5	30,0 - 35,0	182,0	203,0	970,0	2/0
32535	1 x 95 rm / 16	24	12 / 20	5,5	2,5	31,0 - 36,0	182,0	276,0	1120,0	3/0
32536	1 x 120 rm / 16	24	12 / 20	5,5	2,5	32,0 - 38,0	182,0	348,0	1210,0	4/0
32537	1 x 150 rm / 16	24	12 / 20	5,5	2,5	33,0 - 39,0	182,0	435,0	1370,0	300 kcmil
32538	1 x 150 rm / 25	24	12 / 20	5,5	2,5	33,0 - 39,0	283,0	435,0	1420,0	300 kcmil
32539	1 x 185 rm / 16	24	12 / 20	5,5	2,5	35,0 - 41,0	182,0	537,0	1530,0	350 kcmil
32540	1 x 185 rm / 25	24	12 / 20	5,5	2,5	35,0 - 41,0	283,0	537,0	1570,0	350 kcmil
32541	1 x 240 rm / 16	24	12 / 20	5,5	2,5	38,0 - 44,0	182,0	696,0	1720,0	500 kcmil
32542	1 x 240 rm / 25	24	12 / 20	5,5	2,5	38,0 - 44,0	283,0	696,0	1830,0	500 kcmil
32543	1 x 300 rm / 25	24	12 / 20	5,5	2,5	40,0 - 46,0	283,0	870,0	2070,0	600 kcmil
32544	1 x 400 rm / 35	24	12 / 20	5,5	2,5	43,0 - 49,0	394,0	1160,0	2460,0	750 kcmil
32545	1 x 500 rm / 35	24	12 / 20	5,5	2,5	46,0 - 52,0	394,0	1450,0	2890,0	1000 kcmil
33078	1 x 630 rm / 35	24	12 / 20	5,5	2,5	47,0 - 53,0	394,0	1827,0	3370,0	1250 kcmil
32546	1 x 50 rm / 16	36	18 / 30	8	2,5	32,0 - 38,0	182,0	145,0	1120,0	1

Continuation ▶

NA2XS2Y 6/10 kV, 12/20 kV, 18/30 kV

XLPE-insulated, Alu-conductor, single core, screened, PE-sheath



Part no.	No. cores x cross-sec. mm ²	Operation voltage max.	Nominal voltage kV	Insulation thickness mm	Sheath thickness Nominal value mm	Outer Ø min. - max. mm	Cop. weight kg / km	Alu weight kg / km	Weight app. kg / km	AWG-No.
32547	1 x 70 rm / 16	36	18 / 30	8	2,5	34,0 - 40,0	182,0	203,0	1270,0	2/0
32548	1 x 95 rm / 16	36	18 / 30	8	2,5	35,0 - 41,0	182,0	276,0	1380,0	3/0
32549	1 x 120 rm / 16	36	18 / 30	8	2,5	37,0 - 43,0	182,0	348,0	1530,0	4/0
32550	1 x 150 rm / 25	36	18 / 30	8	2,5	38,0 - 44,0	283,0	435,0	1720,0	300 kcmil
32551	1 x 185 rm / 25	36	18 / 30	8	2,5	40,0 - 46,0	283,0	537,0	1860,0	350 kcmil
32552	1 x 240 rm / 25	36	18 / 30	8	2,5	42,0 - 48,0	283,0	696,0	2110,0	500 kcmil
32553	1 x 300 rm / 25	36	18 / 30	8	2,5	45,0 - 51,0	283,0	870,0	2370,0	600 kcmil
32554	1 x 400 rm / 35	36	18 / 30	8	2,5	48,0 - 54,0	394,0	1160,0	2820,0	750 kcmil
32555	1 x 500 rm / 35	36	18 / 30	8	2,5	51,0 - 57,0	394,0	1450,0	3280,0	1000 kcmil
32999	1 x 630 rm / 35	36	18 / 30	8	2,5	52,0 - 59,0	394,0	1827,0	3770,0	1250 kcmil

Dimensions and specifications may be changed without prior notice. (RQ03)

NA2XS(F)2Y 6/10 kV, 12/20 kV, 18/30 kV

XLPE-insulated, alu-conductor, single core, longitudinally watertight, screened, PE-sheath



Technical data

- XLPE-insulated power cables acc. to DIN VDE 0276 part 620, HD 620 S2 and IEC 60502
- **Temperature range**
during installation up to -20°C
- **Operating temperature**
max. +90°C
- **Short circuit temperature**
+250°C (short circuit duration max. 5 s)
- **Nominal voltage**
U₀/U 6/10 kV, 12/20 kV, 18/30 kV
- **Operating voltage, 50 Hz**
for 6/10 kV = max. 12 kV
for 12/20 kV = max. 24 kV
for 18/30 kV = max. 36 kV
- **Test voltage**
for 6/10 kV = 21 kV
for 12/20 kV = 42 kV
for 18/30 kV = 63 kV
- **Minimum bending radius**
15x cable Ø
- **Power rating**
see "Technical Informations"

Cable structure

- Aluminium-conductor, to DIN VDE 0295 cl.2, multi-wire, BS 6360 cl.2, IEC 60228 cl.2
- Inner semi-conducting coating
- Core insulation of cross-linked polyethylene (XLPE), compound type DIX8 to HD 620 S2
- Outer conductive layer extruded and permanently welded with the core insulation
- Longitudinally watertight, conductive wrapping
- Screen: Braiding of copper wires with one or two tapes applied helically
- Longitudinally watertight wrapping
- Outer sheath of PE compound type DMP2 to HD 620 S2
- Sheath colour: black
- Sheath wall thickness
nominal value 2,5 mm

Properties

- The materials used during manufacturing are cadmium-free, contain no silicone and are free from substances harmful to the wetting properties of lacquers
- **Installation notes**
To guarantee an optimum on operating reliability the extruded semi-conductive layer is spliced with the insulation for long duration. For this reason we recommend a peeling tool for installation

Note

- rm = round conductor, multi-wire
- Further types and dimensions on request.
- AWG sizes are approximate equivalent values. The actual cross section is in mm².

Application

Suitable for indoor installation and in cable ducts, outdoors, underground and in water as well as for installation on cable trays for industries, switch-boards and power stations. The PE-outer sheath is resistant to high mechanical stress for laying the cables. This PE sheath is not flame retardant acc. to DIN EN 60332-1-2. The inner conducting layer between the conductor and the XLPE insulation and the firmly bonded outer conducting layer on the XLPE insulation assures a construction free of partial discharges with high operational reliability.

Part no.	No. cores x cross-sec. mm ²	Operation voltage max.	Nominal voltage kV	Insulation thickness mm	Screen cross-sec. mm ²	Outer Ø app. mm	Cop. weight kg / km	Alu weight kg / km	Weight app. kg / km	AWG-No.
32600	1 x 35 rm / 16	12	6 / 10	3,4	16	26,0	182,0	102,0	780,0	2
32601	1 x 50 rm / 16	12	6 / 10	3,4	16	28,0	182,0	145,0	850,0	1
32602	1 x 70 rm / 16	12	6 / 10	3,4	16	30,0	182,0	203,0	980,0	2/0
32603	1 x 95 rm / 16	12	6 / 10	3,4	16	31,0	182,0	276,0	1080,0	3/0
32604	1 x 120 rm / 16	12	6 / 10	3,4	16	32,0	182,0	348,0	1150,0	4/0
32605	1 x 150 rm / 25	12	6 / 10	3,4	25	34,0	283,0	435,0	1280,0	300 kcmil
32606	1 x 185 rm / 25	12	6 / 10	3,4	25	36,0	283,0	537,0	1420,0	350 kcmil
32607	1 x 240 rm / 25	12	6 / 10	3,4	25	38,0	283,0	696,0	1630,0	500 kcmil
32608	1 x 300 rm / 25	12	6 / 10	3,4	25	40,0	283,0	870,0	1950,0	600 kcmil
32609	1 x 400 rm / 35	12	6 / 10	3,4	35	44,0	394,0	1160,0	2350,0	750 kcmil
32610	1 x 500 rm / 35	12	6 / 10	3,4	35	47,0	394,0	1450,0	2780,0	1000 kcmil
32611	1 x 50 rm / 16	24	12 / 20	5,5	16	33,0	182,0	145,0	920,0	1
32612	1 x 70 rm / 16	24	12 / 20	5,5	16	34,0	182,0	203,0	1030,0	2/0
32613	1 x 95 rm / 16	24	12 / 20	5,5	16	36,0	182,0	276,0	1140,0	3/0
32614	1 x 120 rm / 16	24	12 / 20	5,5	16	37,0	182,0	348,0	1250,0	4/0
32615	1 x 150 rm / 25	24	12 / 20	5,5	25	39,0	283,0	435,0	1320,0	300 kcmil
32616	1 x 185 rm / 25	24	12 / 20	5,5	25	41,0	283,0	537,0	1570,0	350 kcmil
32617	1 x 240 rm / 25	24	12 / 20	5,5	25	43,0	283,0	696,0	1780,0	500 kcmil
32618	1 x 300 rm / 25	24	12 / 20	5,5	25	45,0	283,0	870,0	2100,0	600 kcmil
32619	1 x 400 rm / 35	24	12 / 20	5,5	35	48,0	394,0	1160,0	2480,0	750 kcmil
32620	1 x 500 rm / 35	24	12 / 20	5,5	35	50,0	394,0	1450,0	2900,0	1000 kcmil
33090	1 x 630 rm / 35	24	12 / 20	5,5	35	52,0	394,0	1827,0	3380,0	1250 kcmil
33091	1 x 800 rm / 35	24	12 / 20	5,5	35	57,0	394,0	2320,0	4400,0	1500 kcmil
33097	1 x 1000 rm / 35	24	12 / 20	5,5	35	62,0	394,0	2900,0	4780,0	2000 kcmil

Continuation »

NA2XS(F)2Y 6/ 10 kV, 12/20 kV, 18/30 kV

XLPE-insulated, alu-conductor, single core, longitudinally watertight, screened, PE-sheath



Part no.	No. cores x cross-sec. mm ²	Operation voltage max.	Nominal voltage kV	Insulation thickness mm	Screen cross-sec. mm ²	Outer Ø app. mm	Cop. weight kg / km	Alu weight kg / km	Weight app. kg / km	AWG-No.
32621	1 x 50 rm / 16	36	18 / 30	8	16	37,0	182,0	145,0	1250,0	1
32622	1 x 70 rm / 16	36	18 / 30	8	16	38,0	182,0	203,0	1500,0	2/0
32623	1 x 95 rm / 16	36	18 / 30	8	16	40,0	182,0	276,0	1700,0	3/0
32624	1 x 120 rm / 16	36	18 / 30	8	16	42,0	182,0	348,0	1800,0	4/0
32625	1 x 150 rm / 25	36	18 / 30	8	25	43,0	283,0	435,0	2050,0	300 kcmil
32626	1 x 185 rm / 25	36	18 / 30	8	25	45,0	283,0	537,0	2150,0	350 kcmil
32627	1 x 240 rm / 25	36	18 / 30	8	25	47,0	283,0	696,0	2400,0	500 kcmil
32628	1 x 300 rm / 25	36	18 / 30	8	25	50,0	283,0	870,0	2700,0	600 kcmil
32629	1 x 400 rm / 35	36	18 / 30	8	35	53,0	394,0	1160,0	3200,0	750 kcmil
32630	1 x 500 rm / 35	36	18 / 30	8	35	56,0	394,0	1450,0	3555,0	1000 kcmil
31219	1 x 630 rm / 35	36	18 / 30	8	35	58,0	394,0	1827,0	3790,0	1250 kcmil

Dimensions and specifications may be changed without prior notice. (RQ03)

NA2XS(FL)2Y 6/10 kV, 12/20 kV, 18/30 kV

XLPE-insulated, alu-conductor, single core, longitudinally and crosswise watertight, screened, PE-sheath



Technical data

- XLPE-insulated power cables acc. to DIN VDE 0276 part 620, HD 620 S2 and IEC 60502
- **Temperature range**
during installation up to -20°C
- **Operating temperature**
max. +90°C
- **Short circuit temperature**
250°C (short circuit duration max. 5 s)
- **Nominal voltage**
U₀/U 6/10 kV, 12/20 kV, 18/30 kV
- **Operating voltage, 50 Hz**
for 6/10 kV = max. 12 kV
for 12/20 kV = max. 24 kV
for 18/30 kV = max. 36 kV
- **Test voltage**
for 6/10 kV = 21 kV
for 12/20 kV = 42 kV
for 18/30 kV = 63 kV
- **Minimum bending radius**
15x cable Ø
- **Power ratings**
see "Technical Informations"

Cable structure

- Aluminium-conductor, to DIN VDE 0295 cl.2, multi-wire, BS 6360 cl.2, IEC 60228 cl.2
- Inner semi-conducting coating
- Core insulation of cross-linked polyethylene (XLPE), compound type DIX8 to HD 620 S2
- Outer conductive layer extruded and permanently welded with the core insulation
- Longitudinally watertight, conductive wrapping
- Screen: Braiding of copper wires with one or two tapes applied helically
- Longitudinally watertight wrapping
- Aluminium tape spliced with PE sheath
- Outer sheath of PE compound type DMP2 to HD 620 S2
- Sheath colour: black
- Sheath wall thickness
nominal value 2,5 mm

Properties

- The materials used during manufacturing are cadmium-free, contain no silicone and are free from substances harmful to the wetting properties of lacquers
- **Installation notes**
To guarantee an optimum on operating reliability the extruded semi-conductive layer is spliced with the insulation for long duration. For this reason we recommend a peeling tool for installation

Note

- rm = round conductor, multi-wire
- Further types and dimensions on request.
- AWG sizes are approximate equivalent values. The actual cross section is in mm².

Application

Installation primarily for power utility grids and in cable ducts, outdoors, underground and in water, and also on pallets for manufacturing plants, switchgear and power stations. The resistant Al/PE-laminated sheathing acts as a cross water barrier. It inhibits the diffusion of water. In case of sheathing damage, water impact is contained at the flaw. The cable can be severely mechanically stressed during installation and operation. The PE sheathing is not flame-retardant to DIN EN 60332-1-2. The internal conductive layer between conductor and VPE insulation and the adherent external conductive layer on the VPE insulation guarantees a design with high operational safety and no partial discharge.

Part no.	No. cores x cross-sec. mm ²	Operation voltage max.	Nominal voltage kV	Insulation thickness mm	Screen cross-sec. mm ²	Outer Ø app. mm	Cop. weight kg / km	Alu weight kg / km	Weight app. kg / km	AWG-No.
38062	1 x 50 rm / 16	12	6 / 10	3,4	16	30,0	182,0	145,0	710,0	1
38063	1 x 70 rm / 16	12	6 / 10	3,4	16	32,0	182,0	203,0	890,0	2/0
38064	1 x 95 rm / 16	12	6 / 10	3,4	16	33,0	182,0	276,0	1100,0	3/0
38065	1 x 120 rm / 16	12	6 / 10	3,4	16	34,0	182,0	348,0	1330,0	4/0
38066	1 x 150 rm / 25	12	6 / 10	3,4	25	36,0	283,0	435,0	1450,0	300 kcmil
38067	1 x 185 rm / 25	12	6 / 10	3,4	25	38,0	283,0	537,0	1580,0	350 kcmil
38068	1 x 240 rm / 25	12	6 / 10	3,4	25	40,0	283,0	696,0	1780,0	500 kcmil
38069	1 x 300 rm / 25	12	6 / 10	3,4	25	42,0	283,0	870,0	1990,0	600 kcmil
38070	1 x 400 rm / 35	12	6 / 10	3,4	35	46,0	394,0	1160,0	2320,0	750 kcmil
38071	1 x 500 rm / 35	12	6 / 10	3,4	35	49,0	394,0	1450,0	2690,0	1000 kcmil
38072	1 x 630 rm / 35	12	6 / 10	3,4	35	51,0	394,0	1827,0	3160,0	1250 kcmil
38073	1 x 50 rm / 16	24	12 / 20	5,5	16	35,0	182,0	145,0	870,0	1
38074	1 x 70 rm / 16	12	12 / 20	5,5	16	36,0	182,0	203,0	1060,0	2/0
38075	1 x 95 rm / 16	24	12 / 20	5,5	16	38,0	182,0	276,0	1280,0	3/0
38076	1 x 120 rm / 16	24	12 / 20	5,5	16	39,0	182,0	348,0	1520,0	4/0
33089	1 x 150 rm / 25	24	12 / 20	5,5	25	41,0	283,0	435,0	1650,0	300 kcmil
38077	1 x 185 rm / 25	24	12 / 20	5,5	25	43,0	283,0	537,0	1800,0	350 kcmil
38078	1 x 240 rm / 25	24	12 / 20	5,5	25	45,0	283,0	696,0	2000,0	500 kcmil
38079	1 x 300 rm / 25	24	12 / 20	5,5	25	47,0	283,0	870,0	2230,0	600 kcmil
38080	1 x 400 rm / 35	24	12 / 20	5,5	35	50,0	394,0	1160,0	2580,0	750 kcmil
38081	1 x 500 rm / 35	24	12 / 20	5,5	35	54,0	394,0	1450,0	2980,0	1000 kcmil
38082	1 x 630 rm / 35	24	6 / 10	5,5	35	55,0	394,0	1827,0	3480,0	1250 kcmil

Continuation ▶

NA2XS(FL)2Y 6/ 10 kV, 12/20 kV, 18/30 kV

XLPE-insulated, alu-conductor, single core, longitudinally and crosswise watertight, screened, PE-sheath



Part no.	No. cores x cross-sec. mm ²	Operation voltage max.	Nominal voltage kV	Insulation thickness mm	Screen cross-sec. mm ²	Outer Ø app. mm	Cop. weight kg / km	Alu weight kg / km	Weight app. kg / km	AWG-No.
33084	1 x 50 rm / 16	36	18 / 30	8	16	39,0	182,0	145,0	1100,0	1
33085	1 x 70 rm / 16	36	18 / 30	8	16	40,0	182,0	203,0	1300,0	2/0
38083	1 x 95 rm / 16	36	18 / 30	8	16	42,0	182,0	276,0	1530,0	3/0
38084	1 x 120 rm / 16	36	18 / 30	8	16	44,0	182,0	348,0	1780,0	4/0
38085	1 x 150 rm / 25	36	18 / 30	8	25	45,0	283,0	435,0	1920,0	300 kcmil
38086	1 x 185 rm / 25	36	18 / 30	8	25	47,0	283,0	537,0	2080,0	350 kcmil
38087	1 x 240 rm / 25	36	10 / 30	8	25	49,0	283,0	696,0	2300,0	500 kcmil
38088	1 x 300 rm / 25	36	18 / 30	8	25	52,0	283,0	870,0	2550,0	600 kcmil
38089	1 x 400 rm / 35	36	18 / 30	8	35	55,0	394,0	1160,0	2960,0	750 kcmil
38090	1 x 500 rm / 35	36	18 / 30	8	35	30,0	394,0	1450,0	3380,0	1000 kcmil
38091	1 x 630 rm / 35	36	18 / 30	8	35	60,0	394,0	1827,0	3900,0	1250 kcmil

Dimensions and specifications may be changed without prior notice. (RQ03)

HELUWIND® WK POWERLINE ALU MS SINGLE

3,6/6 kV, 12/20 kV, 18/30 kV with flexible ALU stranded wires

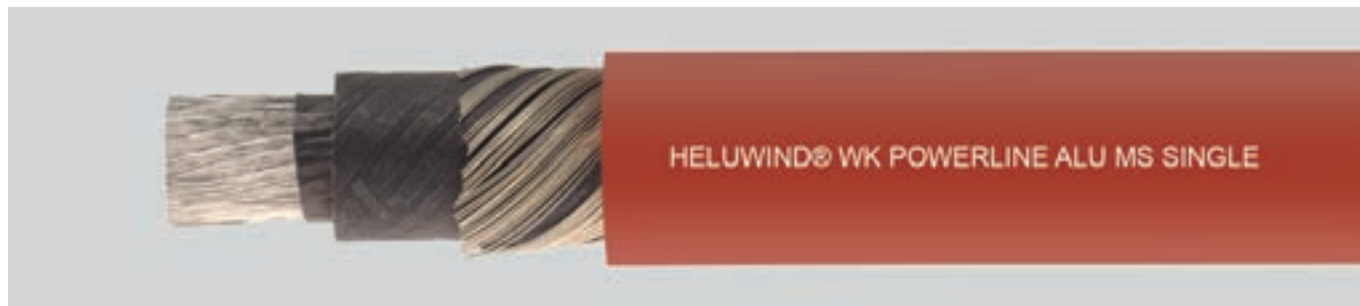

Technical data

- **Temperature range**
flexing -20°C up to +90°C
- **Nominal voltage**
3,6/6 kV,
12/20 kV,
or 18/30 kV
- **Maximum short circuit conductor temperature**
+250°C
- **Minimum bending radius**
flexing 10x cable Ø
fixed installation 8x cable Ø

Cable structure

- **Conductor**
Highly flexible aluminium conductor
Extruded inner semi conductive layer
- **Insulation**
Material EPR
1st semi conductive layer extruded
2nd semi conductive layer tape wrapped
- **Screen wrapped copper wires**
- **Outer sheath**
Material special rubber compound
Colour red

Properties

- Oil resistant
- UV resistant
- Hydrolysis resistant
- Ozone resistant
- Flame retardant
- Heat resistant

Note

For more information, especially on custom cables and connectivity solutions, please contact us: wind@helukabel.de

Application

Designed for use in switchboards and power generators, where very small bending radii are required. In wind turbines, for applications requiring flexible connections; ideal to be fed through the tower in one continuous length. This eliminates cost intensive connection points between the individual tower sections. Not suitable for applications in the cable loop.

3,6/6 (7,2) kV

Part no.	No. cores x cross-sec. mm ²	AWG-No.	Outer Ø app. mm	AL weight kg / km	Weight app. kg / km
712184	1x50	-	25,0	0,0	807,0
712185	1x70	-	27,0	0,0	932,0
712186	1x95	-	28,4	0,0	1039,0
712187	1x120	-	30,8	0,0	1231,0
712188	1x150	-	33,4	0,0	1492,0
712189	1x185	-	34,0	0,0	1633,0
712190	1x240	-	38,1	0,0	1610,0
712192	1x300	-	41,7	0,0	2293,0
712191	1x400	-	46,3	0,0	2791,0

12/20 (24) kV

Part no.	No. cores x cross-sec. mm ²	AWG-No.	Outer Ø app. mm	AL weight kg / km	Weight app. kg / km
712193	1x50	-	31,2	0,0	1214,0
712194	1x70	-	33,4	0,0	1389,0
712195	1x95	-	34,8	0,0	1516,0
712196	1x120	-	37,2	0,0	1756,0

12/20 (24) kV

Part no.	No. cores x cross-sec. mm ²	AWG-No.	Outer Ø app. mm	AL weight kg / km	Weight app. kg / km
712197	1x150	-	39,8	0,0	2043,0
712198	1x185	-	40,4	0,0	2208,0
712199	1x240	-	44,3	0,0	2535,0
712200	1x300	-	47,3	0,0	2884,0
712201	1x400	-	51,7	0,0	3421,0

18/30 (36) kV

Part no.	No. cores x cross-sec. mm ²	AWG-No.	Outer Ø app. mm	AL weight kg / km	Weight app. kg / km
712202	1x50	-	36,6	0,0	1648,0
712203	1x70	-	38,8	0,0	1853,0
712204	1x95	-	40,2	0,0	1997,0
712205	1x120	-	42,6	0,0	2285,0
712206	1x150	-	45,2	0,0	2586,0
712207	1x185	-	45,8	0,0	2771,0
712208	1x240	-	49,7	0,0	3139,0
712209	1x300	-	52,7	0,0	3529,0
712210	1x400	-	57,1	0,0	4123,0

Dimensions and specifications may be changed without prior notice.



Technical Data

- UL 1072
Medium-Voltage Power Cables
MV-90/MV-105 shielded:
5 kV – 46 kV
MV-90 non-shielded:
2.4 kV
- **Temperature range**
during installation up to -5 °C
- **Conductor operation temperatures**
Normal:
MV-90: 90 °C (194 °F)
MV-105: 105 °C (221 °F)
Emergency: 130 °C (266 °F)
Short circuit: 250 °C (482 °F)
- **Maximum operating voltage**
MV-90/MV-105 shielded:
5 kV /8kV/15kV/25kV/ 35 kV 100%
and 133% IL
MV-90 non-shielded :
2.4 kV per UL
5 kV, 100% and 3.0 kV, 133% per ICEA
- **Minimum bending radius**
MV-90 2,4 KV non-shielded =
8 x OD
MV-90 and 105 copper wire shielded =
8 x OD
MV-90 and 105 copper tape shielded =
12 x OD

Cable structure

- **Conductor:**
Soft annealed uncoated copper compacted Class B per ASTM B496 or hard drawn Aluminium-1350 compacted Class B per ASTM B400.
Sizes: 8 AWG (6 AWG Aluminium) up to 1000 kcmil (on request, larger conductor sizes available)
Optional : annealed AA-8000 Aluminium compacted Class B per ASTM B80.
- **Conductor Shield:**
• Semi-conducting cross-linked polyethylene (XLPE).
- **Insulation:**
MV-90: Thermoset cross-linked polyethylene (XLPE).
MV-105: Thermoset ethylene propylene rubber (EPR).
- **Insulation Shield:**
MV-90/MV-105 shielded
Semi conducting cross-linked polyethylene (XLPE).
- **Metallic Shield:**
MV-90/MV-105 shielded
Copper wires shield:
Solid soft annealed uncoated copper wires per ASTM B3, helically applied and uniformly spaced.
Copper tape shield:
Soft annealed uncoated copper tape, 5 mil thick, 25% minimum overlap.
- **Jacket:**
Black sunlight resistance and flame retardant polyvinyl chloride (PVC) compound.

Properties

- Rated as Sunlight Resistance for CT use 1/0 AWG and larger
Oil Resistance I jacket
Flame retardant (PVC jacked)
- **MV-90 / MV-105 shielded:**
ICEA S-93-639/NEMA WC74
5 kV – 46 kV Shielded Power Cables
ICEA S-97-682
Standard for Utility Shielded Power Cables
Rated 5 kV – 46 kV
AIEC CS8
Specification for Extruded Dielectric, Shielded Power Cables Rated 5 kV – 46 kV
- **MV-90 non-shielded:**
ICEA S-96-659/NEMA WC71
Standard for non-shielded cables
Rated 2001-5000 volts for use in the Distribution of Electrical Energy

Optional:

- Halogen free
- EPR/CPE as FT4 rated

Application

MV-90/ MV-105 shielded: Primary power and distribution circuits in industrial and commercial installations, power circuits in generating plants where line to ground fault current are within shield capabilities. May be used in wet or dry locations, installed in raceways, duct, and open air, aerially or directly buried as permitted by NEC. MV-90 non-shielded: Per NEC, use is limited to 2400 V. For use in industrial and utility applications, for dry locations, in accordance with NEC.

Aluminium MV-90 non-shielded 2,4 KV

XLPE Insulated
100% Insulation Level

Size AWG or kcmil	Part no. ALU	Part no. copper	Approx. OD inch	ALU Weight approx. lb/kft	Copper Weight approx. lb/kft
8	711136	711660	0,39	–	94
6	711137	711661	0,42	74	131
4	711138	711662	0,47	97	187
2	711139	711663	0,52	131	273
1	711140	711664	0,55	151	331
1/0	711141	711665	0,59	178	405
2/0	711142	711666	0,63	212	498
3/0	711143	711667	0,68	254	614
4/0	711144	711668	0,73	305	760
250	711145	711669	0,81	361	898
350	711146	711670	0,90	474	1227
500	711147	711671	1,02	641	1715
750	711148	711672	1,22	928	2539
1000	711149	711673	1,38	1197	3344

EPR /PVC Insulated
100%/133% Insulation Levels

Part no. ALU	Part no. copper	Approx. OD inch	ALU Weight approx. lb/kft	Copper Weight approx. lb/kft
711150	711674	0,59	–	208
711151	711675	0,63	197	254
711152	711676	0,67	231	321
711153	711677	0,72	279	422
711154	711678	0,76	308	488
711155	711679	0,79	345	572
711156	711680	0,83	389	675
711157	711681	0,91	470	831
711158	711682	0,96	537	991
711159	711683	1,08	660	1198
711160	711684	1,18	806	1559
711161	711685	1,30	1012	2088
711162	711686	1,54	1434	3047
711163	711687	1,96	1760	3910

Dimensions and specifications may be changed without prior notice.

MV-90 / MV-105 ALUMINIUM / COPPER UL listed



MV-90/MV-105 Aluminium Shielded 5KV, 100% /133% Insulation Levels

MV-90 XLPE/PVC

CU-Tape Shielded

Size AWG or kcmil	Part no. ALU	Part no. copper	Approx. OD inch	ALU Weight approx. lb/kft	Copper Weight approx. lb/kft
8	711164	711688	-	-	-
6	711165	711689	0,59	188	245
4	711166	711690	0,64	221	311
2	711167	711691	0,69	267	410
1	711168	711692	0,72	295	475
1/0	711169	711693	0,76	331	558
2/0	711170	711694	0,80	373	659
3/0	711171	711695	0,89	460	821
4/0	711172	711696	0,94	526	980
250	711173	711697	0,99	586	1124
350	711174	711698	1,09	724	1477
500	711175	711699	1,21	921	1996
750	711176	711700	1,41	1266	2879
1000	711177	711701	1,57	1573	3723

CU Wire Shielded

Part no. ALU	Part no. copper	Approx. OD inch	ALU Weight approx. lb/kft	Copper Weight approx. lb/kft
711178	711702	-	-	-
711179	711703	0,63	172	229
711180	711704	0,68	202	291
711181	711705	0,73	250	392
711182	711706	0,76	275	455
711183	711707	0,80	308	535
711184	711708	0,88	382	668
711185	711709	0,93	433	793
711186	711710	0,98	494	949
711187	711711	1,03	559	1096
711188	711712	1,13	689	1443
711189	711713	1,25	877	1952
711190	711714	1,45	1215	2828
711191	711715	1,61	1510	3660

MV-105 EPR/PVC

CU-Tape Shielded

Size AWG or kcmil	Part no. ALU	Part no. copper	Approx. OD inch	ALU Weight approx. lb/kft	Copper Weight approx. lb/kft
8	711192	711716	-	-	-
6	711193	711717	0,6	204	260
4	711194	711718	0,65	238	328
2	711195	711719	0,70	287	430
1	711196	711720	0,73	316	496
1/0	711197	711721	0,77	354	581
2/0	711198	711722	0,81	398	684
3/0	711199	711723	0,90	488	849
4/0	711200	711724	0,95	556	1011
250	711201	711725	1,01	619	1157
350	711202	711726	1,10	761	1515
500	711203	711727	1,22	964	2039
750	711204	711728	1,43	1318	2931
1000	711205	711729	1,58	1633	3783

CU Wire Shielded

Part no. ALU	Part no. copper	Approx. OD inch	ALU Weight approx. lb/kft	Copper Weight approx. lb/kft
711206	711730	-	-	-
711207	711731	0,65	188	244
711208	711732	0,69	219	309
711209	711733	0,76	280	423
711210	711734	0,79	307	487
711211	711735	0,83	342	568
711212	711736	0,91	419	705
711213	711737	0,96	472	832
711214	711738	1,01	535	990
711215	711739	1,06	602	1140
711216	711740	1,16	737	1490
711217	711741	1,28	930	2005
711218	711742	1,50	1292	2905
711219	711743	1,65	1599	3749

MV-90 XLPE/PVC Shielded 8KV Aluminium

100% Insulation Level

CU-Tape Shielded

Size AWG or kcmil	Part no. ALU	Part no. copper	Approx. OD inch	ALU Weight approx. lb/kft	Copper Weight approx. lb/kft
6	711220	711744	0,65	214	270
4	711221	711745	0,69	248	338
2	711222	711746	0,75	296	438
1	711223	711747	0,78	325	504
1/0	711224	711748	0,81	362	588
2/0	711225	711749	0,89	440	726
3/0	711226	711750	0,94	496	857
4/0	711227	711751	0,99	563	1018
250	711228	711752	1,05	625	1163
300	711229	711753	1,10	697	1341
350	711230	711754	1,14	766	1519
400	711231	711755	1,19	834	1694
500	711232	711756	1,29	991	2066
600	711233	711757	1,37	1129	2419
750	711234	711758	1,47	1318	2931
1000	711235	711759	1,62	1630	3780

CU Wire Shielded

Part no. ALU	Part no. copper	Approx. OD inch	ALU Weight approx. lb/kft	Copper Weight approx. lb/kft
711284	711808	0,68	200	257
711285	711809	0,73	231	321
711286	711810	0,78	279	422
711287	711811	0,81	305	485
711288	711812	0,89	374	601
711289	711813	0,93	416	703
711290	711814	0,98	469	829
711291	711815	1,03	532	986
711292	711816	1,08	598	1136
711293	711817	1,13	666	1310
711294	711818	1,18	732	1485
711295	711819	1,22	797	1657
711296	711820	1,32	946	2021
711297	711821	1,41	1085	2376
711298	711822	1,50	1267	2880
711299	711823	1,66	1568	3718

133% Insulation Level

CU-Tape Shielded

Size AWG or kcmil	Part no. ALU	Part no. copper	Approx. OD inch	ALU Weight approx. lb/kft	Copper Weight approx. lb/kft
6	711236	711760	0,7	241	297
4	711237	711761	0,74	276	366
2	711238	711762	0,80	326	469
1	711239	711763	0,83	356	536
1/0	711240	711764	0,90	429	656
2/0	711241	711765	0,94	476	762
3/0	711242	711766	0,99	533	894
4/0	711243	711767	1,04	601	1056
250	711244	711768	1,10	666	1203
300	711245	711769	1,15	739	1383
350	711246	711770	1,19	809	1563
400	711247	711771	1,24	879	1739
500	711248	711772	1,34	1039	2114
600	711249	711773	1,42	1180	2470
750	711250	711774	1,52	1372	2985
1000	711251	711775	1,67	1688	3838

CU Wire Shielded

Part no. ALU	Part no. copper	Approx. OD inch	ALU Weight approx. lb/kft	Copper Weight approx. lb/kft
711300	711824	0,73	224	280
711301	711825	0,78	256	345
711302	711826	0,87	339	482
711303	711827	0,90	368	548
711304	711828	0,94	405	631
711305	711829	0,98	448	734
711306	711830	1,03	502	863
711307	711831	1,08	566	1021
711308	711832	1,13	635	1172
711309	711833	1,18	704	1349
711310	711834	1,23	771	1524
711311	711835	1,27	838	1698
711312	711836	1,37	990	2066
711313	711837	1,46	1132	2423
711314	711838	1,56	1317	2930
711315	711839	1,77	1726	3876

Dimensions and specifications may be changed without prior notice.

MV-90 / MV-105 ALUMINIUM / COPPER UL listed



MV-105 EPR/PVC Shielded 8KV Aluminium

100% Insulation Level
CU-Tape Shielded

Size AWG or kcmil	Part no. ALU	Part no. copper	Approx. OD inch	ALU Weight approx. lb/kft	Copper Weight approx. lb/kft
6	711252	711776	0,65	234	291
4	711253	711777	0,70	271	361
2	711254	711778	0,75	322	465
1	711255	711779	0,78	352	532
1/0	711256	711780	0,82	392	618
2/0	711257	711781	0,90	473	760
3/0	711258	711782	0,95	532	893
4/0	711259	711783	1,00	602	1057
250	711260	711784	1,06	667	1205
300	711261	711785	1,11	742	1386
350	711262	711786	1,15	814	1567
400	711263	711787	1,20	885	1744
500	711264	711788	1,30	1047	2122
600	711265	711789	1,38	1189	2480
750	711266	711790	1,48	1384	2997
1000	711267	711791	1,63	1705	3855

CU Wire Shielded

Part no. ALU	Part no. copper	Approx. OD inch	ALU Weight approx. lb/kft	Copper Weight approx. lb/kft
711316	711840	0,70	215	271
711317	711841	0,74	248	338
711318	711842	0,81	311	454
711319	711843	0,84	339	519
711320	711844	0,92	412	639
711321	711845	0,96	456	743
711322	711846	1,01	511	872
711323	711847	1,06	577	1032
711324	711848	1,12	647	1184
711325	711849	1,17	717	1362
711326	711850	1,21	785	1539
711327	711851	1,25	853	1713
711328	711852	1,35	1007	2082
711329	711853	1,44	1163	2353
711330	711854	1,55	1354	2967
711331	711855	1,77	1773	3923

133% Insulation Level
CU-Tape Shielded

Size AWG or kcmil	Part no. ALU	Part no. copper	Approx. OD inch	ALU Weight approx. lb/kft	Copper Weight approx. lb/kft
6	711268	711792	0,71	267	324
4	711269	711793	0,75	306	395
2	711270	711794	0,80	359	502
1	711271	711795	0,88	425	605
1/0	711272	711796	0,91	468	694
2/0	711273	711797	0,95	517	803
3/0	711274	711798	1,00	577	938
4/0	711275	711799	1,05	650	1104
250	711276	711800	1,11	718	1255
300	711277	711801	1,16	794	1439
350	711278	711802	1,20	868	1621
400	711279	711803	1,25	941	1801
500	711280	711804	1,35	1107	2182
600	711281	711805	1,43	1253	2544
750	711282	711806	1,53	1452	3065
1000	711283	711807	1,74	1883	4033

CU Wire Shielded

Part no. ALU	Part no. copper	Approx. OD inch	ALU Weight approx. lb/kft	Copper Weight approx. lb/kft
711332	711856	0,75	244	300
711333	711857	0,79	279	368
711334	711858	0,90	380	523
711335	711859	0,94	411	591
711336	711860	0,97	450	677
711337	711861	1,01	496	782
711338	711862	1,06	553	914
711339	711863	1,11	621	1076
711340	711864	1,17	693	1231
711341	711865	1,22	765	1410
711342	711866	1,26	836	1589
711343	711867	1,31	905	1765
711344	711868	1,41	1063	2139
711345	711869	1,49	1223	2513
711346	711870	1,60	1419	3032
711347	711871	1,82	1847	3997

MV-90 XLPE/PVC Shielded 15KV Aluminium

100% Insulation Level
CU-Tape Shielded

Size AWG or kcmil	Part no. ALU	Part no. copper	Approx. OD inch	ALU Weight approx. lb/kft	Copper Weight approx. lb/kft
2	711348	711872	0,91	406	549
1	711349	711873	0,94	438	618
1/0	711350	711874	0,97	480	707
2/0	711351	711875	1,10	528	814
3/0	711352	711876	1,06	587	948
4/0	711353	711877	1,11	658	1113
250	711354	711878	1,17	725	1262
300	711355	711879	1,22	800	1445
350	711356	711880	1,29	897	1651
400	711357	711881	1,33	970	1830
500	711358	711882	1,41	1109	2184
600	711359	711883	1,49	1253	2544
750	711360	711884	1,59	1449	3062
1000	711361	711885	1,80	1879	4029

CU Wire Shielded

Part no. ALU	Part no. copper	Approx. OD inch	ALU Weight approx. lb/kft	Copper Weight approx. lb/kft
711404	711928	0,94	382	524
711405	711929	0,97	412	591
711406	711930	1,01	450	677
711407	711931	1,05	495	781
711408	711932	1,10	551	912
711409	711933	1,15	618	1073
711410	711934	1,20	689	1226
711411	711935	1,25	760	1405
711412	711936	1,32	852	1606
711413	711937	1,37	922	1782
711414	711938	1,44	1055	2130
711415	711939	1,53	1201	2491
711416	711940	1,62	1390	3003
711417	711941	1,84	1810	3960

133% Insulation Level
CU-Tape Shielded

Size AWG or kcmil	Part no. ALU	Part no. copper	Approx. OD inch	ALU Weight approx. lb/kft	Copper Weight approx. lb/kft
2	711362	711886	1,00	472	615
1	711363	711887	1,03	506	686
1/0	711364	711888	1,06	549	776
2/0	711365	711889	1,10	600	886
3/0	711366	711890	1,15	662	1023
4/0	711367	711891	1,20	736	1191
250	711368	711892	1,28	830	1368
300	711369	711893	1,33	909	1554
350	711370	711894	1,38	985	1738
400	711371	711895	1,42	1060	1920
500	711372	711896	1,50	1203	2279
600	711373	711897	1,58	1353	2643
750	711374	711898	1,74	1656	3269
1000	711375	711899	1,92	2047	4197

CU Wire Shielded

Part no. ALU	Part no. copper	Approx. OD inch	ALU Weight approx. lb/kft	Copper Weight approx. lb/kft
711418	711942	1,03	441	583
711419	711943	1,06	472	652
711420	711944	1,10	513	740
711421	711945	1,14	561	847
711422	711946	1,19	619	980
711423	711947	1,24	689	1144
711424	711948	1,32	785	1323
711425	711949	1,37	861	1505
711426	711950	1,41	933	1687
711427	711951	1,46	1005	1865
711428	711952	1,53	1142	2218
711429	711953	1,62	1293	2584
711430	711954	1,78	1592	3205
711431	711955	1,96	1968	4118

Dimensions and specifications may be changed without prior notice.

MV-90 / MV-105 ALUMINIUM / COPPER UL listed



MV-105 EPR/PVC Shielded 15KV Aluminium

100% Insulation Level

CU-Tape Shielded

Size AWG or kcmil	Part no. ALU	Part no. copper	Approx. OD inch	ALU Weight approx. lb/kft	Copper Weight approx. lb/kft
2	711376	711900	0,92	451	593
1	711377	711901	0,95	486	666
1/0	711378	711902	0,99	530	757
2/0	711379	711903	1,03	582	868
3/0	711380	711904	1,07	645	1006
4/0	711381	711905	1,12	720	1175
250	711382	711906	1,18	791	1329
300	711383	711907	1,23	871	1515
350	711384	711908	1,30	973	1726
400	711385	711909	1,34	1049	1909
500	711386	711910	1,42	1195	2270
600	711387	711911	1,51	1346	2637
750	711388	711912	1,60	1551	3163
1000	711389	711913	1,82	1995	4145

CU Wire Shielded

Part no. ALU	Part no. copper	Approx. OD inch	ALU Weight approx. lb/kft	Copper Weight approx. lb/kft
711432	711956	0,98	437	580
711433	711957	1,01	470	649
711434	711958	1,04	511	738
711435	711959	1,08	560	846
711436	711960	1,13	619	980
711437	711961	1,18	690	1145
711438	711962	1,24	766	1303
711439	711963	1,29	841	1486
711440	711964	1,36	938	1691
711441	711965	1,40	1010	1870
711442	711966	1,48	1150	2225
711443	711967	1,58	1305	2569
711444	711968	1,69	1508	3121
711445	711969	1,91	1951	4101

133% Insulation Level

CU-Tape Shielded

Size AWG or kcmil	Part no. ALU	Part no. copper	Approx. OD inch	ALU Weight approx. lb/kft	Copper Weight approx. lb/kft
2	711390	711914	1,01	532	675
1	711391	711915	1,04	569	749
1/0	711392	711916	1,08	616	843
2/0	711393	711917	1,12	671	957
3/0	711394	711918	1,16	738	1099
4/0	711395	711919	1,22	817	1272
250	711396	711920	1,29	918	1456
300	711397	711921	1,34	1002	1647
350	711398	711922	1,39	1083	1837
400	711399	711923	1,43	1163	2023
500	711400	711924	1,51	1314	2389
600	711401	711925	1,60	1472	2763
750	711402	711926	1,76	1789	3402
1000	711403	711927	1,94	2197	4347

CU Wire Shielded

Part no. ALU	Part no. copper	Approx. OD inch	ALU Weight approx. lb/kft	Copper Weight approx. lb/kft
711446	711970	1,07	511	654
711447	711971	1,10	546	726
711448	711972	1,14	591	817
711449	711973	1,18	642	928
711450	711974	1,22	705	1066
711451	711975	1,27	780	1235
711452	711976	1,35	883	1421
711453	711977	1,40	964	1608
711454	711978	1,45	1041	1794
711455	711979	1,49	1117	1977
711456	711980	1,57	1262	2338
711457	711981	1,67	1424	2715
711458	711982	1,85	1746	3359
711459	711983	2,03	2144	4294

MV-90 XLPE/PVC Shielded 25KV Aluminium

100% Insulation Level

CU-Tape Shielded

Size AWG or kcmil	Part no. ALU	Part no. copper	Approx. OD inch	ALU Weight approx. lb/kft	Copper Weight approx. lb/kft
1	711460	711984	1,10	570	749
1/0	711461	711985	1,14	616	841
2/0	711462	711986	1,18	668	953
3/0	711463	711987	1,23	733	1092
4/0	711464	711988	1,30	834	1288
250	711465	711989	1,36	907	1444
300	711466	711990	1,41	989	1633
350	711467	711991	1,45	1067	1820
400	711468	711992	1,49	1144	2003
500	711469	711993	1,57	1292	2366
600	711470	711994	1,66	1445	2735
750	711471	711995	1,82	1758	3370
1000	711472	711996	2,00	2158	4307

CU Wire Shielded

Part no. ALU	Part no. copper	Approx. OD inch	ALU Weight approx. lb/kft	Copper Weight approx. lb/kft
711512	712036	1,14	535	715
711513	712037	1,18	577	804
711514	712038	1,22	627	913
711515	712039	1,27	688	1048
711516	712040	1,34	783	1238
711517	712041	1,40	861	1399
711518	712042	1,45	939	1583
711519	712043	1,49	1014	1767
711520	712044	1,54	1087	1947
711521	712045	1,61	1229	2304
711522	712046	1,76	1487	2778
711523	712047	1,86	1692	3305
711524	712048	2,04	2078	4228

133% Insulation Level

CU-Tape Shielded

Size AWG or kcmil	Part no. ALU	Part no. copper	Approx. OD inch	ALU Weight approx. lb/kft	Copper Weight approx. lb/kft
1	711473	711997	1,23	675	854
1/0	711474	711998	1,29	747	974
2/0	711475	711999	1,33	804	1090
3/0	711476	712000	1,37	872	1233
4/0	711477	712001	1,43	953	1408
250	711478	712002	1,48	1031	1569
300	711479	712003	1,53	1116	1761
350	711480	712004	1,58	1198	1951
400	711481	712005	1,62	1278	2138
500	711482	712006	1,76	1534	2610
600	711483	712007	1,88	1748	3039
750	711484	712008	1,97	1969	3582
1000	711485	712009	2,12	2333	4483

CU Wire Shielded

Part no. ALU	Part no. copper	Approx. OD inch	ALU Weight approx. lb/kft	Copper Weight approx. lb/kft
711525	712049	-	-	-
711526	712050	1,32	702	929
711527	712051	1,36	756	1042
711528	712052	1,41	821	1181
711529	712053	1,46	898	1353
711530	712054	1,52	980	1517
711531	712055	1,57	1061	1706
711532	712056	1,61	1139	1893
711533	712057	1,66	1216	2076
711534	712058	1,79	1469	2544
711535	712059	1,91	1682	2972
711536	712060	2,01	1896	3509
711537	712061	2,16	2248	4398

Dimensions and specifications may be changed without prior notice.

MV-90 / MV-105 ALUMINIUM/COPPER UL listed



MV-105 EPR/PVC Shielded 25KV Aluminium

100% Insulation Level
CU-Tape Shielded

Size AWG or kcmil	Part no. ALU	Part no. copper	Approx. OD inch	ALU Weight approx. lb/kft	Copper Weight approx. lb/kft
1	711486	712010	1,21	649	829
1/0	711487	712011	1,16	699	926
2/0	711488	712012	1,20	757	1043
3/0	711489	712013	1,25	827	1187
4/0	711490	712014	1,32	935	1390
250	711491	712015	1,38	1016	1553
300	711492	712016	1,43	1103	1748
350	711493	712017	1,47	1178	1940
400	711494	712018	1,52	1269	2129
500	711495	712019	1,59	1426	2501
600	711496	712020	1,68	1590	2881
750	711497	712021	1,84	1918	3531
1000	711498	712022	2,02	2338	4488

CU Wire Shielded

Part no. ALU	Part no. copper	Approx. OD inch	ALU Weight approx. lb/kft	Copper Weight approx. lb/kft
711538	712062	1,18	624	804
711539	712063	1,22	671	898
711540	712064	1,26	726	1012
711541	712065	1,30	792	1153
711542	712066	1,38	895	1349
711543	712067	1,43	983	1521
711544	712068	1,48	1066	1711
711545	712069	1,53	1147	1900
711546	712070	1,57	1226	2086
711547	712071	1,65	1376	2452
711548	712072	1,82	1649	2940
711549	712073	1,93	1875	3488
711550	712074	2,11	2286	4436

133% Insulation Level
CU-Tape Shielded

Size AWG or kcmil	Part no. ALU	Part no. copper	Approx. OD inch	ALU Weight approx. lb/kft	Copper Weight approx. lb/kft
1	711499	712023	1,23	713	910
1/0	711500	712024	1,30	859	1086
2/0	711501	712025	1,34	922	1208
3/0	711502	712026	1,39	997	1358
4/0	711503	712027	1,44	1086	1541
250	711504	712028	1,50	1172	1709
300	711505	712029	1,55	1264	1909
350	711506	712030	1,59	1353	2106
400	711507	712031	1,64	1440	2300
500	711508	712032	1,78	1710	2786
600	711509	712033	1,90	1939	3229
750	711510	712034	1,99	2174	3787
1000	711511	712035	2,14	2561	4711

CU Wire Shielded

Part no. ALU	Part no. copper	Approx. OD inch	ALU Weight approx. lb/kft	Copper Weight approx. lb/kft
711551	712075	1,3	746	926
711552	712076	1,36	820	1047
711553	712077	1,4	879	1165
711554	712078	1,45	951	1312
711555	712079	1,5	1036	1491
711556	712080	1,56	1130	1668
711557	712081	1,61	1219	1863
711558	712082	1,65	1304	2057
711559	712083	1,7	1387	2247
711560	712084	1,83	1655	2730
711561	712085	1,97	1882	3173
711562	712086	2,08	2122	3735
711563	712087	2,23	2501	4651

MV-90 XLPE/PVC Shielded 35KV Aluminium

100% Insulation Level
CU-Tape Shielded

Size AWG or kcmil	Part no. ALU	Part no. copper	Approx. OD inch	ALU Weight approx. lb/kft	Copper Weight approx. lb/kft
1/0	711564	712088	1,34	795	1022
2/0	711565	712089	1,38	853	1139
3/0	711566	712090	1,42	923	1284
4/0	711567	712091	1,48	1006	1461
250	711568	712092	1,53	1085	1623
300	711569	712093	1,58	1172	1817
350	711570	712094	1,63	1255	2009
400	711571	712095	1,67	1337	2197
500	711572	712096	1,81	1598	2674
600	711573	712097	1,93	1816	3107
750	711574	712098	2,02	2040	3653
1000	711575	712099	2,17	2409	4559

CU Wire Shielded

Part no. ALU	Part no. copper	Approx. OD inch	ALU Weight approx. lb/kft	Copper Weight approx. lb/kft
711612	712136	1,37	746	973
711613	712137	1,41	801	1087
711614	712138	1,46	868	1228
711615	712139	1,51	947	1401
711616	712140	1,57	1030	1568
711617	712141	1,62	1113	1758
711618	712142	1,66	1193	1946
711619	712143	1,77	1375	2235
711620	712144	1,84	1529	2604
711621	712145	1,96	1746	3036
711622	712146	2,06	1963	3576
711623	712147	2,21	2320	4470

133% Insulation Level
CU-Tape Shielded

Size AWG or kcmil	Part no. ALU	Part no. copper	Approx. OD inch	ALU Weight approx. lb/kft	Copper Weight approx. lb/kft
1/0	711576	712100	1,49	949	1176
2/0	711577	712101	1,53	1010	1296
3/0	711578	712102	1,57	1085	1446
4/0	711579	712103	1,63	1173	1627
250	711580	712104	1,74	1359	1897
300	711581	712105	1,79	1454	2098
350	711582	712106	1,84	1544	2297
400	711583	712107	1,91	1681	2541
500	711584	712108	1,99	1850	2926
600	711585	712109	2,08	2029	3320
750	711586	712110	2,17	2262	3875
1000	711587	712111	2,32	2645	4795

CU Wire Shielded

Part no. ALU	Part no. copper	Approx. OD inch	ALU Weight approx. lb/kft	Copper Weight approx. lb/kft
711624	712148	1,52	889	1116
711625	712149	1,56	947	1223
711626	712150	1,61	1018	1379
711627	712151	1,66	1102	1557
711628	712152	1,78	1295	1832
711629	712153	1,83	1385	2030
711630	712154	1,87	1472	2225
711631	712155	1,95	1604	2464
711632	712156	2,02	1767	2843
711633	712157	2,11	1947	3238
711634	712158	2,21	2175	3787
711635	712159	2,36	2545	4695

Dimensions and specifications may be changed without prior notice.

MV-90 / MV-105 ALUMINIUM/COPPER UL listed



MV-105 EPR/PVC Shielded 35KV Aluminium

100% Insulation Level
CU-Tape Shielded

Size AWG or kcmil	Part no. ALU	Part no. copper	Approx. OD inch	ALU Weight approx. lb/kft	Copper Weight approx. lb/kft
1/0	711588	712112	1,36	920	1147
2/0	711589	712113	1,40	984	1270
3/0	711590	712114	1,44	1061	1422
4/0	711591	712115	1,49	1153	1607
250	711592	712116	1,55	1241	1778
300	711593	712117	1,60	1335	1980
350	711594	712118	1,65	1426	2179
400	711595	712119	1,75	1619	2479
500	711596	712120	1,83	1791	2867
600	711597	712121	1,95	2025	3315
750	711598	712122	2,04	2264	3877
1000	711599	712123	2,19	2658	4808

CU Wire Shielded

Part no. ALU	Part no. copper	Approx. OD inch	ALU Weight approx. lb/kft	Copper Weight approx. lb/kft
711636	712160	1,41	881	1108
711637	712161	1,45	942	1228
711638	712162	1,50	1016	1376
711639	712163	1,55	1103	1558
711640	712164	1,61	1199	1737
711641	712165	1,66	1290	1934
711642	712166	1,77	1482	2236
711643	712167	1,81	1580	2430
711644	712168	1,89	1736	2812
711645	712169	2,02	1969	3260
711646	712170	2,13	2214	3827
711647	712171	2,28	2599	4749

133% Insulation Level
CU-Tape Shielded

Size AWG or kcmil	Part no. ALU	Part no. copper	Approx. OD inch	ALU Weight approx. lb/kft	Copper Weight approx. lb/kft
1/0	711600	712124	1,51	1115	1341
2/0	711601	712125	1,55	1184	1470
3/0	711602	712126	1,60	1267	1628
4/0	711603	712127	1,65	1365	1820
250	711604	712128	1,76	1565	2103
300	711605	712129	1,81	1669	2314
350	711606	712130	1,86	1769	2522
400	711607	712131	1,94	1919	2776
500	711608	712132	2,01	2100	3176
600	711609	712133	2,10	2296	3586
750	711610	712134	2,19	2548	4161
1000	711611	712135	2,35	2960	5110

CU Wire Shielded

Part no. ALU	Part no. copper	Approx. OD inch	ALU Weight approx. lb/kft	Copper Weight approx. lb/kft
711648	712172	1,57	1064	1291
711649	712173	1,61	1130	1416
711650	712174	1,65	1210	1570
711651	712175	1,77	1409	1864
711652	712176	1,82	1516	2053
711653	712177	1,87	1616	2260
711654	712178	1,92	1711	2465
711655	712179	1,99	1853	2713
711656	712180	2,07	2031	3106
711657	712181	2,17	2229	3519
711658	712182	2,29	2487	4100
711659	712183	2,44	2892	5042

Dimensions and specifications may be changed without prior notice.





JZ-500 HMH-C

JZ-500

JZ-600-Y-CY UL/CSA

F-CY-JZ

HELUTHERM® 145 MULTI

H07 RN-F

MEGAFLEX® 500

■ CONTROL CABLES

Designation	Page
HEL UWIND® WK Lift	110
JZ-500	111
JZ-500 COLD	113
F-CY-JZ	114
Y-CY-JZ	116
JZ-500 HMH	118
JZ-500 HMH-C	120
MEGAFLEX® 500	122
MEGAFLEX® 500-C	124
JZ-600	126
JZ-600-Y-CY	128
JZ-600 HMH	130
JZ-600 HMH-C	132
JZ-600 UL/CSA	134
JZ-600-Y-CY UL/CSA	136
JZ-602	138
JZ-602-CY	140
JZ-603	142
JZ-603-CY	143
H07RN-F	145
SOOW	147
HEL UWIND® WK POWERLINE ALU MULTI	148
HELUTHERM® 145 MULTI	149
HELUTHERM® 145 MULTI-C	151

HELUWIND® WK Lift

UV resistant, halogen-free

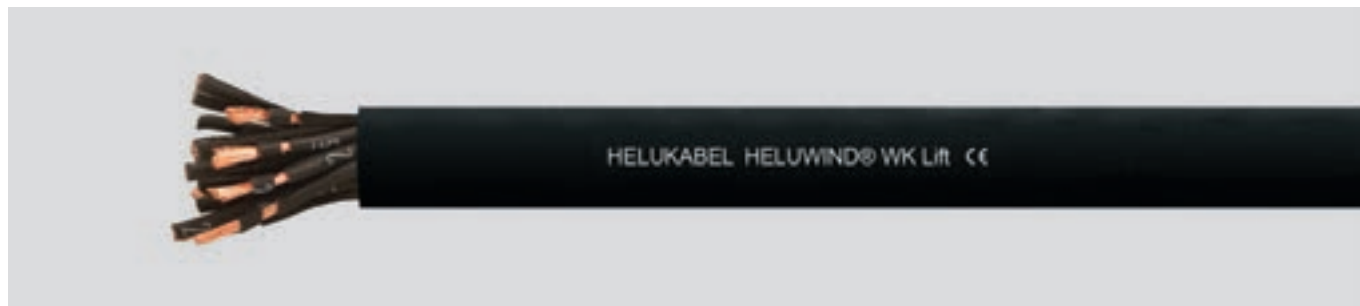

Technical data

- **Temperature range**
flexing -35°C to +80°C
fixed installation -40°C to +80°C
- **Nominal voltage**
U₀/U 300/500 V
- **Test voltage**
3000 V
- **Insulation resistance**
min. 100 MΩ x km
- **Minimum bending radius**
flexing 7,5x cable Ø
fixed installation 4x cable Ø
- **Radiation resistance**
up to 100x10⁶ cJ/kg (up to 100 Mrad)

Cable structure

- Bare copper, fine wire conductor, Unilay with short pitch length
- Core insulation of special PP
- Core identification black cores with continuous white numbering
- GN-YE conductor, 3 cores and above
- Bunch-construction with low torsion
- Outer sheath of special PUR, extruded as filler with pressure
- Sheath colour: black (RAL 9005)
- With meter marking

Properties

- Low adhesion
- Ozon- and UV resistant
- Oil resistant
- Better chemical resistance
- Tear resistance
- The materials used during manufacturing are cadmium-free, contain no silicone and are free from substances harmful to the wetting properties of lacquers

Tests

- Halogen-free acc. to DIN VDE 0482 part 267, DIN EN 50267-2-1, IEC 60754-1 (equivalent DIN VDE 0472 part 815)

Note

For more information, especially on custom cables and connectivity solutions, please contact us: wind@helukabel.de. For each application is an individual assessment and selection by the technical department necessary.

Optional:

- with 600V
- UL recognized or UL listed

Application

WK Lift was designed for power supply applications and control of service lifts in wind turbines. The construction of the cable must be designed for the application cable trolley system or pot cable version. Please note the assembly instruction for untwisted laying without torsion for cables with moving and reeling application. The max. free hanging height depends on cross-section and number of cores. For certain weight loads and lift heights a supporting braid must be integrated into the cable.

JZ-500

flexible, number coded, meter marking



Technical data

- Special-PVC control cable adapted to DIN VDE 0285-525-2-51 / DIN EN 50525-2-51
- **Temperature range**
flexing -15°C to +80°C
fixed installation -40°C to +80°C
- **Nominal voltage**
U₀/U 300/500 V
- **Test voltage**
4000 V
- **Breakdown voltage**
min. 8000 V
- **Insulation resistance**
min. 20 MOhm x km
- **Minimum bending radius**
flexing 7,5x cable Ø
fixed installation 4x cable Ø
- **Radiation resistance**
up to 80x10⁶ cJ/kg (up to 80 Mrad)

Cable structure

- Bare copper conductor, to DIN VDE 0295 cl.5, fine wire, BS 6360 cl.5, IEC 60228 cl.5
- Core insulation of special PVC compound type Z 7225
- Core identification to DIN VDE 0293 black cores with continuous white numbering (also available in other colours on request)
- GN-YE conductor, 3 cores and above in the outer layer
- Cores stranded in layers with optimal lay length
- Outer sheath of special PVC compound type TM2 to DIN VDE 0207-363-4-1 / DIN EN 50363-4-1
- Sheath colour: grey (RAL 7001)
- With meter marking

Properties

- Extensively oil resistant, oil-/chemical resistance see "Technical Informations"
- Conditional drag chain compatible
- Conditional suitability for torsion
- The materials used during manufacturing are cadmium-free, contain no silicone and are free from substances harmful to the wetting properties of lacquers

Tests

- PVC self-extinguishing and flame retardant acc. to DIN VDE 0482-332-1-2, DIN EN 60332-1-2, IEC 60332-1-2 (equivalent DIN VDE 0472 part 804 test method B)

Note

- G = with GN-YE conductor
x = without GN-YE conductor (OZ)
- We supply any "desired length" of stranded cores without outer sheath, core insulation colour acc. RAL 9005 with number combination acc. customers requirement.
- Please note "cleanroom qualified" when ordering.
- AWG sizes are approximate equivalent values. The actual cross section is in mm².
- Screened analogue type:
F-CY-JZ,
F-CY-OZ (LiY-CY),
Y-CY-JB,
Y-CY-JZ

Application

These cables are appropriate for flexible use with medium mechanical stresses, and free movement without tensile stress or forced movements in dry, moist and wet rooms but not open air. Suitable to be used as measuring and control cables in tool machines, conveyor belts, assembly lines, plant engineering, AC technology, steel production and other manufacturing environments. Selected PVC compounds guarantee good flexibility as well as an economic and fast installation.

☑ = Product conforms with Low-Voltage Directive 2014/35/EU.

Part no.	No. cores x cross-sec. mm ²	Outer Ø app. mm	Cop. weight kg / km	Weight app. kg / km	AWG-No.	Part no.	No. cores x cross-sec. mm ²	Outer Ø app. mm	Cop. weight kg / km	Weight app. kg / km	AWG-No.
10001	2 x 0,5	4,8	9,6	40,0	20	10183	16 G 0,5	10,0	76,0	175,0	20
10002	3 G 0,5	5,1	14,4	46,0	20	10016	18 G 0,5	10,7	86,0	196,0	20
10003	3 x 0,5	5,1	14,4	46,0	20	10017	20 G 0,5	11,3	96,0	215,0	20
10004	4 G 0,5	5,5	19,0	56,0	20	10018	21 G 0,5	11,3	101,0	240,0	20
10005	4 x 0,5	5,5	19,0	56,0	20	10019	25 G 0,5	12,6	120,0	270,0	20
10006	5 G 0,5	6,2	24,0	65,0	20	10020	30 G 0,5	13,5	144,0	310,0	20
10007	5 x 0,5	6,2	24,0	65,0	20	10021	32 G 0,5	14,0	154,0	323,0	20
10008	6 G 0,5	6,7	29,0	75,0	20	10022	34 G 0,5	14,7	163,0	362,0	20
10009	7 G 0,5	6,7	33,6	80,0	20	10023	40 G 0,5	15,3	192,0	434,0	20
10010	7 x 0,5	6,7	33,6	80,0	20	10024	42 G 0,5	15,8	202,0	449,0	20
10011	8 G 0,5	7,7	38,0	97,0	20	10025	50 G 0,5	17,3	240,0	513,0	20
10172	8 x 0,5	7,7	38,0	97,0	20	10169	52 G 0,5	17,3	252,0	534,0	20
10012	10 G 0,5	8,6	48,0	116,0	20	10026	61 G 0,5	18,5	293,0	625,0	20
10013	12 G 0,5	9,1	58,0	135,0	20	10027	65 G 0,5	19,8	312,0	682,0	20
10014	12 x 0,5	8,7	58,0	135,0	20	10028	80 G 0,5	21,3	384,0	780,0	20
10015	14 G 0,5	9,5	67,0	150,0	20	10029	100 G 0,5	23,8	480,0	980,0	20

Continuation ▶

JZ-500

flexible, number coded, meter marking



Part no.	No. cores x cross-sec. mm ²	Outer Ø app. mm	Cop. weight kg / km	Weight app. kg / km	AWG-No.
10030	2 x 0,75	5,3	14,4	46,0	19
10031	3 G 0,75	5,6	21,6	54,0	19
10032	3 x 0,75	5,6	21,6	54,0	19
10033	4 G 0,75	6,3	28,8	66,0	19
10034	4 x 0,75	6,3	29,0	66,0	19
10035	5 G 0,75	6,9	36,0	80,0	19
10036	5 x 0,75	6,9	36,0	80,0	19
10037	6 G 0,75	7,7	43,0	99,0	19
10177	6 x 0,75	7,7	43,0	99,0	19
10038	7 G 0,75	7,7	50,0	110,0	19
10039	7 x 0,75	7,7	50,0	110,0	19
10040	8 G 0,75	8,5	58,0	130,0	19
10173	8 x 0,75	8,5	58,0	130,0	19
10041	9 G 0,75	9,8	65,0	153,0	19
10042	10 G 0,75	9,8	72,0	162,0	19
10043	12 G 0,75	10,1	86,0	179,0	19
10044	12 x 0,75	10,1	86,0	179,0	19
10045	14 G 0,75	10,8	101,0	214,0	19
10046	15 G 0,75	11,4	108,0	218,0	19
10047	18 G 0,75	12,2	130,0	257,0	19
10533	19 G 0,75	12,2	137,0	264,0	19
10048	20 G 0,75	12,8	144,0	286,0	19
10049	21 G 0,75	12,8	151,0	320,0	19
10050	25 G 0,75	14,3	180,0	365,0	19
10534	27 G 0,75	14,8	195,0	382,0	19
10051	32 G 0,75	15,9	230,0	455,0	19
10052	34 G 0,75	16,7	245,0	510,0	19
10182	37 G 0,75	16,7	266,0	537,0	19
10053	40 G 0,75	17,3	288,0	595,0	19
10054	41 G 0,75	18,2	296,0	607,0	19
10055	42 G 0,75	18,2	302,0	612,0	19
10056	50 G 0,75	19,8	360,0	735,0	19
10057	61 G 0,75	21,2	439,0	845,0	19
10178	65 G 0,75	22,6	468,0	895,0	19
10058	80 G 0,75	24,3	576,0	1070,0	19
10059	100 G 0,75	27,1	720,0	1322,0	19
10060	2 x 1	5,6	19,2	60,0	18
10061	3 G 1	6,1	29,0	72,0	18
10062	3 x 1	6,1	29,0	72,0	18
10063	4 G 1	6,7	38,0	86,0	18
10064	4 x 1	6,7	38,0	86,0	18
10065	5 G 1	7,5	48,0	104,0	18
10066	5 x 1	7,5	48,0	104,0	18
10067	6 G 1	8,1	58,0	125,0	18
10068	7 G 1	8,1	67,0	141,0	18
10069	7 x 1	8,1	67,0	141,0	18
10070	8 G 1	9,2	77,0	175,0	18
10071	9 G 1	10,6	86,0	200,0	18
10180	10 G 1	10,6	96,0	217,0	18
10170	10 x 1	10,6	96,0	217,0	18
10072	12 G 1	10,9	115,0	230,0	18
10073	12 x 1	10,9	115,0	230,0	18
10074	14 G 1	11,5	134,0	271,0	18
10075	16 G 1	12,3	154,0	300,0	18
10076	18 G 1	12,9	173,0	343,0	18
10174	18 x 1	12,9	173,0	343,0	18
10197	19 G 1	12,9	182,0	355,0	18
10077	20 G 1	13,8	192,0	375,0	18
10184	20 x 1	13,8	192,0	375,0	18
10179	21 G 1	13,8	205,0	420,0	18
10175	24 G 1	15,4	230,0	440,0	18
10078	25 G 1	15,4	240,0	485,0	18
10176	25 x 1	15,4	240,0	485,0	18
10196	26 G 1	15,4	252,0	500,0	18
10198	27 G 1	15,7	259,0	534,0	18
10168	30 x 1	16,5	308,0	550,0	18
10079	34 G 1	17,9	326,0	650,0	18
10080	36 G 1	17,9	346,0	668,0	18
10199	37 G 1	17,9	355,0	701,0	18
10081	40 G 1	18,6	384,0	755,0	18
10167	40 x 1	18,6	384,0	755,0	18
10082	41 G 1	19,5	394,0	770,0	18
10083	42 G 1	19,5	403,0	810,0	18
10084	50 G 1	21,3	480,0	936,0	18
10085	56 G 1	22,1	538,0	920,0	18
10086	61 G 1	22,7	586,0	1100,0	18
10087	65 G 1	24,3	628,0	1180,0	18
10088	80 G 1	26,3	768,0	1294,0	18
10089	100 G 1	29,3	960,0	1644,0	18
10090	2 x 1,5	6,4	29,0	70,0	16
10091	3 G 1,5	6,8	43,0	90,0	16
10092	3 x 1,5	6,8	43,0	90,0	16
10093	4 G 1,5	7,6	58,0	109,0	16
10094	4 x 1,5	7,6	58,0	109,0	16
10095	5 G 1,5	8,3	72,0	131,0	16
10096	5 x 1,5	8,3	72,0	131,0	16
10097	6 G 1,5	9,2	86,0	157,0	16

Part no.	No. cores x cross-sec. mm ²	Outer Ø app. mm	Cop. weight kg / km	Weight app. kg / km	AWG-No.
10098	7 G 1,5	9,2	101,0	184,0	16
10099	7 x 1,5	9,2	101,0	184,0	16
10100	8 G 1,5	10,5	115,0	216,0	16
10101	9 G 1,5	12,0	129,0	259,0	16
10181	10 G 1,5	12,0	144,0	275,0	16
10102	11 G 1,5	12,0	158,0	300,0	16
10103	12 G 1,5	12,4	173,0	309,0	16
10104	12 x 1,5	12,4	173,0	309,0	16
10105	14 G 1,5	13,0	202,0	345,0	16
10106	16 G 1,5	13,9	230,0	386,0	16
10107	18 G 1,5	14,8	259,0	440,0	16
10185	19 G 1,5	14,8	279,0	445,0	16
10108	20 G 1,5	15,6	288,0	490,0	16
10109	21 G 1,5	15,6	302,0	555,0	16
10110	25 G 1,5	17,6	360,0	620,0	16
10535	27 G 1,5	18,0	389,0	670,0	16
10111	32 G 1,5	19,5	461,0	790,0	16
10112	34 x 1,5	20,2	490,0	830,0	16
10536	37 G 1,5	20,2	533,0	892,0	16
10113	41 G 1,5	22,2	591,0	996,0	16
10114	42 G 1,5	22,2	605,0	1007,0	16
10115	50 G 1,5	24,2	720,0	1250,0	16
10116	56 G 1,5	25,1	806,0	1332,0	16
10117	61 G 1,5	25,8	878,0	1440,0	16
10187	65 G 1,5	27,8	936,0	1602,0	16
10118	80 G 1,5	29,8	1152,0	1871,0	16
10119	100 G 1,5	33,2	1440,0	2353,0	16
10120	2 x 2,5	7,8	48,0	112,0	14
10121	3 G 2,5	8,3	72,0	148,0	14
10122	3 x 2,5	8,3	72,0	148,0	14
10123	4 G 2,5	9,3	96,0	178,0	14
10124	4 x 2,5	9,3	96,0	178,0	14
10125	5 G 2,5	10,1	120,0	221,0	14
10126	5 x 2,5	10,1	120,0	221,0	14
10127	7 G 2,5	11,2	168,0	306,0	14
10128	7 x 2,5	11,2	168,0	306,0	14
10129	8 G 2,5	12,8	192,0	363,0	14
10548	10 G 2,5	14,8	240,0	429,0	14
10130	12 G 2,5	15,3	288,0	498,0	14
10131	14 G 2,5	16,2	336,0	569,0	14
10132	18 G 2,5	18,2	432,0	764,0	14
10133	21 G 2,5	19,4	504,0	914,0	14
10134	25 G 2,5	21,6	600,0	1044,0	14
10135	34 G 2,5	25,2	816,0	1470,0	14
10136	42 G 2,5	27,4	1008,0	1790,0	14
10137	50 G 2,5	30,1	1200,0	2095,0	14
10138	61 G 2,5	32,2	1464,0	2750,0	14
10139	100 G 2,5	41,4	2400,0	4450,0	14
10140	2 x 4	9,2	77,0	195,0	12
10141	3 G 4	9,8	115,0	230,0	12
10142	4 G 4	10,9	154,0	295,0	12
10143	5 G 4	12,1	192,0	361,0	12
10144	7 G 4	13,4	269,0	458,0	12
10145	8 G 4	15,2	307,0	590,0	12
10549	10 G 4	17,6	384,0	687,0	12
10146	12 G 4	18,2	461,0	790,0	12
10147	3 G 6	11,9	173,0	355,0	10
10148	4 G 6	13,2	230,0	424,0	10
10149	5 G 6	14,7	288,0	525,0	10
10150	7 G 6	16,2	403,0	625,0	10
10151	3 G 10	14,9	288,0	540,0	8
10152	4 G 10	16,6	384,0	701,0	8
10153	5 G 10	18,3	480,0	858,0	8
10154	7 G 10	20,2	672,0	1106,0	8
10190	3 G 16	18,5	461,0	827,0	6
10155	4 G 16	20,6	614,0	1035,0	6
10156	5 G 16	22,8	768,0	1259,0	6
10157	7 G 16	25,2	1075,0	1780,0	6
10191	3 G 25	22,5	720,0	1186,0	4
10158	4 G 25	25,2	960,0	1582,0	4
10159	5 G 25	27,9	1200,0	1999,0	4
10160	7 G 25	30,8	1680,0	2825,0	4
10192	3 G 35	25,3	1008,0	1585,0	2
10161	4 G 35	28,1	1344,0	2105,0	2
10162	5 G 35	31,0	1680,0	2633,0	2
10193	3 G 50	30,0	1440,0	2550,0	1
10163	4 G 50	33,3	1920,0	2940,0	1
10188	5 G 50	37,0	2400,0	2936,0	1
10194	3 G 70	34,2	2016,0	3180,0	2/0
10164	4 G 70	38,2	2688,0	4090,0	2/0
10189	5 G 70	42,4	3360,0	5443,0	2/0
10195	3 G 95	39,8	2736,0	4680,0	3/0
10165	4 G 95	44,2	3648,0	5540,0	3/0
10333	5 G 95	49,0	4560,0	6931,0	3/0
10166	4 G 120	49,4	4608,0	7000,0	4/0
13139	4 G 150	54,7	5760,0	8340,0	300 kcmil
13140	4 G 185	62,7	7104,0	9904,0	350 kcmil

Dimensions and specifications may be changed without prior notice. (RA01)

JZ-500 COLD

flexible at low temperature, number coded, meter marking

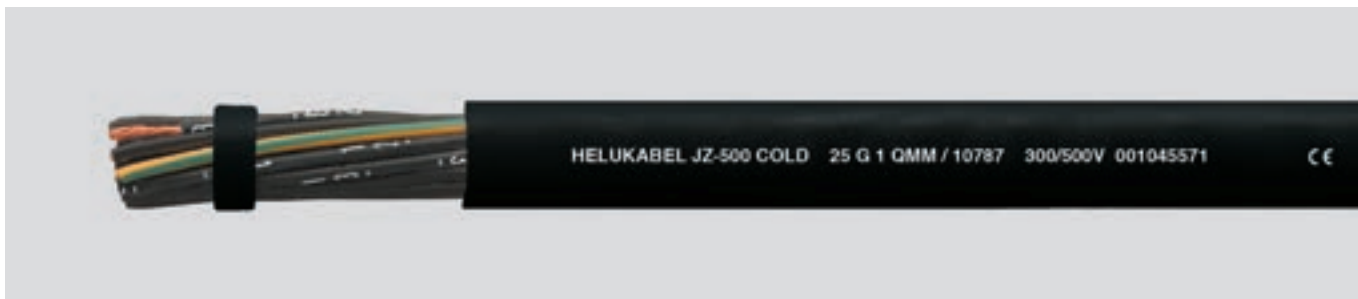

Technical data

- Special-PVC control cable adapted to DIN VDE 0285-525-2-51 / DIN EN 50525-2-51
- **Temperature range**
flexing -30°C to +80°C
fixed installation -40°C to +80°C
- **Nominal voltage**
U₀/U 300/500 V
- **Test voltage**
4000 V
- **Breakdown voltage**
min. 8000 V
- **Insulation resistance**
min. 20 MOhm x km
- **Minimum bending radius**
flexing 7,5x cable Ø
fixed installation 4x cable Ø
- **Radiation resistance**
up to 80x10⁶ cJ/kg (up to 80 Mrad)

Cable structure

- Bare copper conductor, to DIN VDE 0295 cl.5, fine wire, BS 6360 cl.5, IEC 60228 cl.5
- Core insulation of special PVC compound type Y14
- Core identification to DIN VDE 0293 black cores with continuous white numbering
- GN-YE conductor, 3 cores and above in the outer layer
- Cores stranded in layers with optimal lay length
- Outer sheath of cold flexible special PVC
- Sheath colour: black (RAL 9005)
- With meter marking

Properties

- Extensively oil resistant, oil-/chemical resistance see "Technical Informations"
- The materials used during manufacturing are cadmium-free, contain no silicone and are free from substances harmful to the wetting properties of lacquers

Tests

- PVC self-extinguishing and flame retardant acc. to DIN VDE 0482-332-1-2, DIN EN 60332-1-2, IEC 60332-1-2 (equivalent DIN VDE 0472 part 804 test method B)

Note

- G = with GN-YE conductor
x = without GN-YE conductor (OZ)
- AWG sizes are approximate equivalent values. The actual cross section is in mm².

Application

This cold-flexible PVC hose cable is used under average stress for flexible applications with free movement, without tensile load and without forced motion guide in dry, moist, wet rooms and outside, as measuring and control cable at machine tools, conveyor belts and transport belts, production streets, in plant construction, in air condition construction and in refrigerated warehouses. Selected PVC mixtures guarantee good flexibility, efficient and fast installation.

☑ = Product conforms with Low-Voltage Directive 2014/35/EU.

Part no.	No.cores x cross-sec. mm ²	Outer Ø app. mm	Cop. weight kg / km	Weight app. kg / km	AWG-No.
10750	2 x 0,5	4,8	9,6	40,0	20
10751	3 G 0,75	5,6	21,6	54,0	19
10752	3 x 0,75	5,6	21,6	54,0	19
10753	4 G 0,75	6,3	28,8	66,0	19
10754	4 x 0,75	6,3	29,0	66,0	19
10755	5 G 0,75	6,9	36,0	80,0	19
10756	5 x 0,75	6,9	36,0	80,0	19
10757	7 G 0,75	7,5	50,0	110,0	19
10758	7 x 0,75	7,5	50,0	110,0	19
10759	12 G 0,75	9,8	86,0	179,0	19
10760	18 G 0,75	12,2	130,0	257,0	19
10761	25 G 0,75	14,3	180,0	365,0	19
10762	2 x 1	5,6	19,2	60,0	18
10763	3 G 1	5,9	29,0	72,0	18
10764	3 x 1	5,9	29,0	72,0	18
10765	4 G 1	6,6	38,4	86,0	18
10766	4 x 1	6,6	38,4	86,0	18
10767	5 G 1	7,3	48,0	104,0	18
10768	5 x 1	7,3	48,0	104,0	18
10769	7 G 1	8,1	67,0	141,0	18
10770	7 x 1	8,1	67,0	141,0	18
10771	12 G 1	10,4	115,0	230,0	18
10772	18 G 1	12,9	173,0	343,0	18
10773	25 G 1	15,4	240,0	485,0	18

Part no.	No.cores x cross-sec. mm ²	Outer Ø app. mm	Cop. weight kg / km	Weight app. kg / km	AWG-No.
10774	2 x 1,5	6,4	29,0	70,0	16
10775	3 G 1,5	6,8	43,0	90,0	16
10776	3 x 1,5	6,8	43,0	90,0	16
10777	4 G 1,5	7,4	58,0	109,0	16
10778	4 x 1,5	7,4	58,0	109,0	16
10779	5 G 1,5	8,3	72,0	131,0	16
10780	5 x 1,5	8,3	72,0	131,0	16
10781	6 G 1,5	9,2	86,0	157,0	16
10782	7 G 1,5	9,2	101,0	184,0	16
10783	7 x 1,5	9,2	101,0	184,0	16
10784	12 G 1,5	11,8	173,0	309,0	16
10785	18 G 1,5	14,6	259,0	440,0	16
10786	25 G 1,5	17,4	360,0	620,0	16
10787	2 x 2,5	7,8	48,0	112,0	14
10788	3 G 2,5	8,3	72,0	148,0	14
10789	3 x 2,5	8,3	72,0	148,0	14
10790	4 G 2,5	9,2	96,0	178,0	14
10791	4 x 2,5	9,2	96,0	178,0	14
10792	5 G 2,5	10,1	120,0	221,0	14
10793	5 x 2,5	10,1	120,0	221,0	14
10794	7 G 2,5	11,2	168,0	306,0	14
10795	7 x 2,5	11,2	168,0	306,0	14
10796	4 G 6	13,0	230,0	424,0	10
10797	5 G 6	14,5	288,0	525,0	10

Dimensions and specifications may be changed without prior notice. (RA01)

F-CY-JZ

flexible, Cu-screened, EMC-preferred type, meter marking



Technical data

- Special-PVC control cable adapted to DIN VDE 0285-525-2-51 / DIN EN 50525-2-51
- **Temperature range**
flexing -10°C to +80°C
fixed installation -40°C to +80°C
- **Nominal voltage**
U₀/U 300/500 V
- **Test voltage**
core/core 4000 V
core/screen 2000 V
- **Breakdown voltage**
min. 8000 V
- **Insulation resistance**
min. 20 MOhm x km
- **Mutual capacitance**
acc. to different cross sections
0,5 up to 2,5 mm²:
core/core approx. 150 nF/km
core/screen approx. 270 nF/km
- **Coupling resistance**
max. 250 Ohm/km
- **Minimum bending radius**
flexing 10x cable Ø
fixed installation 5x cable Ø
- **Radiation resistance**
up to 80x10⁶ cJ/kg (up to 80 Mrad)

Cable structure

- Bare copper conductor, to DIN VDE 0295 cl.5, fine wire, BS 6360 cl.5, IEC 60228 cl.5
- Core insulation of special PVC compound type Z 7225
- Core identification to DIN VDE 0293 black cores with continuous white numbering
- GN-YE conductor, 3 cores and above in the outer layer
- Cores stranded in layers with optimal lay length
- Foil separator
- Tinned copper braided screening, approx. 85% coverage
- Outer sheath of special PVC compound type TM2 to DIN VDE 0207-363-4-1/DIN EN 50363-4-1
- Sheath colour: grey (RAL 7001)
- With meter marking

Properties

- Extensively oil resistant, oil-/chemical resistance see "Technical Informations"
- The materials used during manufacturing are cadmium-free, contain no silicone and are free from substances harmful to the wetting properties of lacquers

Tests

- PVC self-extinguishing and flame retardant acc. to DIN VDE 0482-332-1-2, DIN EN 60332-1-2, IEC 60332-1-2 (equivalent DIN VDE 0472 part 804 test method B)

Note

- G = with GN-YE conductor
x = without GN-YE conductor (OZ)
- Please note "cleanroom qualified" when ordering.
- AWG sizes are approximate equivalent values. The actual cross section is in mm².
- Unscreened analogue type:

JZ-500

Application

For use as a data cable in control circuits, in tool-making and machine industries as well as a signal cable in computer systems and electronics. The more usual PVC inner sheath has been replaced in these cables by a stabilising foil separator, thus reducing the total diameter of the cables considerably and thereby reducing the bending radius, total weight etc. The high covering percentage of the copper screening offers interference-free signal transfer etc. The dense screening assures disturbance-free transmission of all signals and impulses. An ideal disturbance-free control cable for the above application.

EMC = Electromagnetic compatibility

To optimize the EMC features we recommend a large round contact of the copper braiding on both ends.

= Product conforms with Low-Voltage Directive 2014/35/EU.

Part no.	No. cores x cross-sec. mm ²	Outer Ø app. mm	Cop. weight kg / km	Weight app. kg / km	AWG-No.
16320	2 x 0,5	5,7	35,0	45,0	20
16321	3 G 0,5	6,0	42,0	55,0	20
16322	4 G 0,5	6,5	47,0	61,0	20
16323	5 G 0,5	6,9	56,0	74,0	20
16324	6 G 0,5	7,6	67,0	89,0	20
16325	7 G 0,5	7,6	69,0	98,0	20
16326	8 G 0,5	8,4	80,0	117,0	20
16327	10 G 0,5	9,5	94,0	135,0	20
16328	12 G 0,5	9,8	108,0	157,0	20
16329	14 G 0,5	10,4	116,0	190,0	20
16330	16 G 0,5	10,9	129,0	210,0	20
16331	18 G 0,5	11,4	145,0	217,0	20
16332	20 G 0,5	12,2	172,0	240,0	20

Part no.	No. cores x cross-sec. mm ²	Outer Ø app. mm	Cop. weight kg / km	Weight app. kg / km	AWG-No.
16333	21 G 0,5	12,2	188,0	250,0	20
16334	24 G 0,5	13,7	235,0	300,0	20
16335	25 G 0,5	13,7	240,0	314,0	20
16336	30 G 0,5	14,4	295,0	360,0	20
16337	32 G 0,5	15,1	301,0	425,0	20
16165	34 G 0,5	15,6	312,0	433,0	20
16338	36 G 0,5	15,6	318,0	446,0	20
16339	40 G 0,5	16,4	343,0	475,0	20
16490	41 G 0,5	17,0	348,0	486,0	20
16340	50 G 0,5	18,5	406,0	573,0	20
16341	61 G 0,5	19,6	508,0	653,0	20
16342	80 G 0,5	22,5	680,0	784,0	20
16343	100 G 0,5	25,0	804,0	995,0	20

Continuation ▶

F-CY-JZ

flexible, Cu-screened, EMC-preferred type, meter marking



Part no.	No.cores x cross-sec. mm ²	Outer Ø app. mm	Cop. weight kg / km	Weight app. kg / km	AWG-No.	Part no.	No.cores x cross-sec. mm ²	Outer Ø app. mm	Cop. weight kg / km	Weight app. kg / km	AWG-No.
16344	2 x 0,75	6,2	40,0	59,0	19	16394	3 G 1,5	7,7	80,0	100,0	16
16345	3 G 0,75	6,6	52,0	66,0	19	16395	4 G 1,5	8,3	97,0	126,0	16
16346	4 G 0,75	7,1	60,0	77,0	19	16396	5 G 1,5	9,2	119,0	160,0	16
16347	5 G 0,75	7,8	71,0	93,0	19	16397	7 G 1,5	9,9	147,0	208,0	16
16348	6 G 0,75	8,4	80,0	113,0	19	16398	8 G 1,5	11,2	170,0	244,0	16
16349	7 G 0,75	8,4	91,0	130,0	19	16399	10 G 1,5	12,7	193,0	315,0	16
16350	8 G 0,75	9,5	110,0	145,0	19	16400	12 G 1,5	13,5	267,0	338,0	16
16351	10 G 0,75	10,7	137,0	180,0	19	16401	14 G 1,5	14,1	283,0	383,0	16
16353	12 G 0,75	11,1	142,0	202,0	19	16402	16 G 1,5	15,0	315,0	424,0	16
16354	14 G 0,75	11,5	180,0	225,0	19	16403	18 G 1,5	15,7	374,0	479,0	16
16355	16 G 0,75	12,3	200,0	275,0	19	16449	19 G 1,5	15,7	386,0	508,0	16
16356	18 G 0,75	12,9	212,0	292,0	19	16404	20 G 1,5	16,7	396,0	545,0	16
16447	19 G 0,75	12,9	230,0	308,0	19	16405	21 G 1,5	16,7	425,0	560,0	16
16357	20 G 0,75	13,9	238,0	320,0	19	16406	24 G 1,5	18,5	458,0	690,0	16
16358	21 G 0,75	13,9	246,0	378,0	19	16407	25 G 1,5	18,5	526,0	705,0	16
16359	24 G 0,75	15,4	270,0	435,0	19	16450	27 G 1,5	19,1	531,0	774,0	16
16360	25 G 0,75	15,4	281,0	415,0	19	16408	28 G 1,5	19,7	541,0	810,0	16
16361	27 G 0,75	15,7	304,0	435,0	19	16409	30 G 1,5	19,7	555,0	830,0	16
16362	30 G 0,75	16,4	320,0	450,0	19	16410	35 G 1,5	21,3	645,0	890,0	16
16363	32 G 0,75	17,0	342,0	484,0	19	16451	37 G 1,5	21,3	674,0	945,0	16
16166	34 G 0,75	17,8	345,0	502,0	19	16411	40 G 1,5	22,3	725,0	1060,0	16
16364	36 G 0,75	17,8	350,0	535,0	19	16493	41 G 1,5	23,1	801,0	1071,0	16
16448	37 G 0,75	17,8	361,0	592,0	19	16412	50 G 1,5	25,5	885,0	1290,0	16
16365	40 G 0,75	18,4	369,0	610,0	19	16413	61 G 1,5	27,1	1100,0	1705,0	16
16491	41 G 0,75	19,3	400,0	622,0	19	16414	80 G 1,5	31,1	1324,0	2010,0	16
16366	50 G 0,75	21,0	461,0	777,0	19	16415	100 G 1,5	34,5	1641,0	2505,0	16
16367	61 G 0,75	22,3	540,0	900,0	19	16416	2 x 2,5	8,5	96,0	130,0	14
16368	80 G 0,75	25,7	711,0	1210,0	19	16417	3 G 2,5	9,2	144,0	167,0	14
16369	100 G 0,75	28,5	900,0	1445,0	19	16418	4 G 2,5	10,0	148,0	195,0	14
16370	2 x 1	6,5	50,0	65,0	18	16419	5 G 2,5	11,0	181,0	223,0	14
16371	3 G 1	6,9	60,0	80,0	18	16420	7 G 2,5	12,1	255,0	344,0	14
16372	4 G 1	7,6	71,0	98,0	18	16421	10 G 2,5	15,7	340,0	460,0	14
16373	5 G 1	8,2	88,0	127,0	18	16438	12 G 2,5	16,4	441,0	570,0	14
16374	6 G 1	9,0	97,0	144,0	18	16452	18 G 2,5	19,3	570,0	681,0	14
16375	7 G 1	9,0	111,0	158,0	18	16422	2 x 4	10,5	120,0	185,0	12
16376	8 G 1	10,0	127,0	197,0	18	16423	3 G 4	11,1	174,0	240,0	12
16377	10 G 1	11,3	150,0	232,0	18	16424	4 G 4	12,3	230,0	310,0	12
16378	12 G 1	11,9	184,0	260,0	18	16425	5 G 4	13,8	273,0	385,0	12
16379	14 G 1	12,4	196,0	302,0	18	16426	7 G 4	15,1	316,0	500,0	12
16380	16 G 1	13,0	209,0	346,0	18	16427	2 x 6	11,9	173,0	268,0	10
16381	18 G 1	14,0	260,0	380,0	18	16428	3 G 6	12,6	240,0	330,0	10
16352	19 G 1	14,0	280,0	412,0	18	16429	4 G 6	14,2	305,0	415,0	10
16382	20 G 1	14,9	317,0	440,0	18	16430	5 G 6	15,6	439,0	509,0	10
16383	24 G 1	16,5	320,0	493,0	18	16431	7 G 6	17,1	505,0	672,0	10
16384	25 G 1	16,5	349,0	534,0	18	16432	2 x 10	15,3	255,0	425,0	8
16439	27 G 1	16,9	400,0	562,0	18	16433	3 G 10	16,5	350,0	500,0	8
16385	28 G 1	17,6	408,0	595,0	18	16434	4 G 10	18,2	535,0	783,0	8
16386	30 G 1	17,6	441,0	616,0	18	16435	5 G 10	20,0	592,0	856,0	8
16387	34 G 1	19,0	486,0	741,0	18	16436	7 G 10	22,1	810,0	1305,0	8
16446	37 G 1	19,0	519,0	790,0	18	16458	3 G 16	19,0	585,0	795,0	6
16388	40 G 1	19,7	510,0	835,0	18	16440	4 G 16	21,0	740,0	880,0	6
16492	41 G 1	20,6	531,0	843,0	18	16437	5 G 16	23,1	895,0	1295,0	6
16389	50 G 1	22,4	625,0	1025,0	18	16441	4 G 25	26,4	1140,0	1570,0	4
16390	61 G 1	23,8	702,0	1205,0	18	16442	5 G 25	29,0	1380,0	1965,0	4
16391	80 G 1	27,4	920,0	1445,0	18	16443	4 G 35	29,0	1576,0	2070,0	2
16392	100 G 1	30,6	1120,0	1613,0	18	16444	5 G 35	32,3	1930,0	2690,0	2
16393	2 x 1,5	7,1	63,0	88,0	16	16445	4 G 50	34,8	2155,0	3015,0	1

Dimensions and specifications may be changed without prior notice. (RA01)

Y-CY-JZ

flexible, Cu-screened, transparent, EMC-preferred type, meter marking



Technical data

- Special-PVC control cable adapted to DIN VDE 0285-525-2-51 / DIN EN 50525-2-51
- **Temperature range**
flexing -15°C to +80°C
fixed installation -40°C to +80°C
- **Nominal voltage**
U₀/U 300/500 V
- **Test voltage**
4000 V
- **Breakdown voltage**
min. 8000 V
- **Insulation resistance**
min. 20 MOhm x km
- **Mutual capacitance**
acc. to different cross sections
0,5 up to 2,5 mm²:
core/core approx. 150 nF/km
core/screen approx. 270 nF/km
- **Coupling resistance**
max. 250 Ohm/km
- **Minimum bending radius**
flexing 10x cable Ø
fixed installation 5x cable Ø
- **Radiation resistance**
up to 80x10⁶ cJ/kg (up to 80 Mrad)

Cable structure

- Bare copper conductor, to DIN VDE 0295 cl.5, fine wire, BS 6360 cl.5, IEC 60228 cl.5
- Core insulation of special PVC compound type Z 7225
- Core identification to DIN VDE 0293 black cores with continuous white numbering
- GN-YE conductor, 3 cores and above in the outer layer
- Cores stranded in layers with optimal lay length
- Inner sheath of PVC, grey
- Tinned copper braided screen, approx. 85% coverage
- Outer sheath of special PVC
- Sheath colour: transparent
- With meter marking

Properties

- Extensively oil resistant, oil-/chemical resistance see "Technical Informations"
- The materials used during manufacturing are cadmium-free, contain no silicone and are free from substances harmful to the wetting properties of lacquers

Tests

- PVC self-extinguishing and flame retardant acc. to DIN VDE 0482-332-1-2, DIN EN 60332-1-2, IEC 60332-1-2 (equivalent DIN VDE 0472 part 804 test method B)

Note

- G = with GN-YEconductor
x = without GN-YE conductor (OZ)
- AWG sizes are approximate equivalent values. The actual cross section is in mm².
- Unscreened analogue type:

JZ-500

Application

For use as a data and control cable in machinery, computer systems etc. as well as a signal cable for electronics. The high level of screening ensures a high degree of interference protection. The screening density assures disturbancefree transmission of all signals and impulses. The PVC-inner sheaths of those cables raise the mechanical stress. The applied clear transparent PVC outer sheath accentuates the optical view of the tinned copper braid.

EMC = Electromagnetic compatibility

To optimize the EMC features we recommend a large round contact of the copper braiding on both ends.

= Product conforms with Low-Voltage Directive 2014/35/EU.

Part no.	No. cores x cross-sec. mm ²	Outer Ø app. mm	Cop. weight kg / km	Weight app. kg / km	AWG-No.
16200	2 x 0,5	7,0	41,0	67,0	20
16201	3 G 0,5	7,3	45,0	83,0	20
16169	3 x 0,5	7,3	45,0	83,0	20
16202	4 G 0,5	7,9	54,0	94,0	20
16170	4 x 0,5	7,9	54,0	94,0	20
16203	5 G 0,5	8,4	66,0	108,0	20
16171	5 x 0,5	8,4	66,0	108,0	20
16204	6 G 0,5	9,1	73,0	125,0	20
16205	7 G 0,5	9,1	79,0	136,0	20
17172	7 x 0,5	9,1	79,0	136,0	20
16206	8 G 0,5	9,7	82,0	150,0	20
16207	10 G 0,5	10,7	107,0	170,0	20
16208	12 G 0,5	11,5	137,0	195,0	20
16209	14 G 0,5	12,2	142,0	223,0	20
16210	16 G 0,5	12,7	147,0	250,0	20

Part no.	No. cores x cross-sec. mm ²	Outer Ø app. mm	Cop. weight kg / km	Weight app. kg / km	AWG-No.
16211	18 G 0,5	13,5	156,0	277,0	20
16212	20 G 0,5	14,2	173,0	310,0	20
16315	21 G 0,5	14,2	189,0	331,0	20
16213	24 G 0,5	15,5	236,0	390,0	20
16214	25 G 0,5	15,7	250,0	407,0	20
16215	30 G 0,5	16,2	297,0	520,0	20
16216	32 G 0,5	17,0	312,0	550,0	20
16217	36 G 0,5	17,7	320,0	585,0	20
16218	40 G 0,5	18,4	345,0	654,0	20
16453	41 G 0,5	18,9	348,0	671,0	20
16219	50 G 0,5	20,7	407,0	740,0	20
16220	61 G 0,5	22,0	520,0	850,0	20
16221	80 G 0,5	25,0	690,0	1080,0	20
16222	100 G 0,5	27,4	805,0	1350,0	20

Continuation ▶

Y-CY-JZ

flexible, Cu-screened, transparent, EMC-preferred type, meter marking



Part no.	No.cores x cross-sec. mm ²	Outer Ø app. mm	Cop. weight kg / km	Weight app. kg / km	AWG-No.	Part no.	No.cores x cross-sec. mm ²	Outer Ø app. mm	Cop. weight kg / km	Weight app. kg / km	AWG-No.
16223	2 x 0,75	7,7	46,0	87,0	19	16181	4 x 1,5	9,8	99,0	168,0	16
16224	3 G 0,75	8,0	57,0	98,0	19	16274	5 G 1,5	10,8	123,0	202,0	16
16173	3 x 0,75	8,0	57,0	98,0	19	16182	5 x 1,5	10,8	123,0	202,0	16
16225	4 G 0,75	8,5	63,0	113,0	19	16275	7 G 1,5	11,7	148,0	304,0	16
16196	4 x 0,75	8,5	63,0	113,0	19	16183	7 x 1,5	11,7	148,0	304,0	16
16226	5 G 0,75	9,3	76,0	130,0	19	16276	8 G 1,5	12,6	172,0	336,0	16
16174	5 x 0,75	9,3	76,0	130,0	19	16277	10 G 1,5	14,2	198,0	420,0	16
16227	6 G 0,75	9,9	82,0	156,0	19	16278	12 G 1,5	14,9	274,0	434,0	16
16228	7 G 0,75	9,9	100,0	184,0	19	16279	14 G 1,5	15,8	294,0	480,0	16
16175	7 x 0,75	9,9	100,0	184,0	19	16280	16 G 1,5	16,7	318,0	525,0	16
16229	8 G 0,75	10,6	112,0	221,0	19	16281	18 G 1,5	17,4	386,0	640,0	16
16230	10 G 0,75	11,8	140,0	270,0	19	16282	20 G 1,5	18,5	401,0	690,0	16
16231	12 G 0,75	12,7	175,0	292,0	19	16317	21 G 1,5	18,5	447,0	720,0	16
16232	14 G 0,75	13,3	190,0	315,0	19	16283	24 G 1,5	20,4	487,0	770,0	16
16233	16 G 0,75	14,1	204,0	335,0	19	16284	25 G 1,5	20,8	531,0	805,0	16
16234	18 G 0,75	14,9	240,0	358,0	19	16285	28 G 1,5	21,4	562,0	900,0	16
16235	20 G 0,75	15,4	262,0	420,0	19	16286	30 G 1,5	21,6	598,0	950,0	16
16316	21 G 0,75	15,4	274,0	454,0	19	16287	35 G 1,5	23,2	685,0	1100,0	16
16236	24 G 0,75	17,3	291,0	480,0	19	16288	40 G 1,5	24,5	759,0	1350,0	16
16237	25 G 0,75	17,5	306,0	508,0	19	16456	41 G 1,5	25,0	840,0	1381,0	16
16238	27 G 0,75	17,7	326,0	535,0	19	16289	50 G 1,5	27,4	997,0	1675,0	16
16239	30 G 0,75	18,3	340,0	640,0	19	16290	61 G 1,5	29,2	1120,0	1800,0	16
16240	32 G 0,75	18,9	349,0	688,0	19	16291	80 G 1,5	33,4	1360,0	2300,0	16
16241	36 G 0,75	19,7	358,0	730,0	19	16292	100 G 1,5	36,8	1690,0	2600,0	16
16242	40 G 0,75	20,4	371,0	950,0	19	16293	2 x 2,5	10,1	110,0	180,0	14
16454	41 G 0,75	21,0	403,0	971,0	19	16294	3 G 2,5	10,8	148,0	216,0	14
16243	50 G 0,75	23,2	470,0	1100,0	19	16295	4 G 2,5	11,5	169,0	267,0	14
16244	61 G 0,75	24,6	550,0	1290,0	19	16296	5 G 2,5	12,8	220,0	347,0	14
16245	80 G 0,75	28,3	715,0	1510,0	19	16297	7 G 2,5	14,0	284,0	407,0	14
16246	100 G 0,75	31,1	910,0	1640,0	19	16298	10 G 2,5	16,8	369,0	660,0	14
16248	2 x 1	8,0	54,0	97,0	18	16318	12 G 2,5	17,9	470,0	722,0	14
16249	3 G 1	8,3	64,0	103,0	18	16299	2 x 4	11,6	124,0	302,0	12
16176	3 x 1	8,3	64,0	103,0	18	16300	3 G 4	12,5	178,0	340,0	12
16250	4 G 1	9,0	76,0	146,0	18	16301	4 G 4	13,7	234,0	410,0	12
16177	4 x 1	9,0	76,0	146,0	18	16302	5 G 4	14,9	284,0	502,0	12
16251	5 G 1	9,7	89,0	169,0	18	16303	7 G 4	16,2	321,0	638,0	12
16178	5 x 1	9,7	89,0	169,0	18	16304	2 x 6	13,7	176,0	350,0	10
16252	6 G 1	10,3	101,0	199,0	18	16305	3 G 6	14,4	245,0	450,0	10
16253	7 G 1	10,3	114,0	219,0	18	16306	4 G 6	15,7	316,0	559,0	10
16179	7 x 1	10,3	114,0	219,0	18	16307	5 G 6	17,3	442,0	702,0	10
16254	8 G 1	11,2	130,0	270,0	18	16308	7 G 6	19,0	530,0	907,0	10
16255	10 G 1	12,6	156,0	330,0	18	16309	2 x 10	16,6	260,0	500,0	8
16256	12 G 1	13,3	186,0	350,0	18	16310	3 G 10	17,6	367,0	750,0	8
16257	14 G 1	14,1	198,0	400,0	18	16311	4 G 10	19,4	549,0	1020,0	8
16258	16 G 1	14,8	214,0	422,0	18	16312	5 G 10	21,3	604,0	1115,0	8
16259	18 G 1	15,6	284,0	514,0	18	16313	7 G 10	23,4	820,0	1500,0	8
16260	20 G 1	16,4	325,0	545,0	18	16460	4 G 16	23,4	807,0	1380,0	6
16261	24 G 1	18,2	366,0	640,0	18	16314	5 G 16	26,0	940,0	1553,0	6
16262	25 G 1	18,5	387,0	689,0	18	16461	4 G 25	28,3	1169,0	1890,0	4
16263	28 G 1	19,1	421,0	710,0	18	16462	5 G 25	31,5	1420,0	2270,0	4
16264	30 G 1	19,2	457,0	762,0	18	16463	4 G 35	32,9	1680,0	2390,0	2
16265	34 G 1	20,9	500,0	910,0	18	16464	5 G 35	36,9	2020,0	2885,0	2
16266	40 G 1	21,5	536,0	1070,0	18	16465	4 G 50	38,6	2370,0	3315,0	1
16455	41 G 1	22,2	578,0	1092,0	18	16157	5 G 50	43,5	2880,0	4150,0	1
16267	50 G 1	24,8	681,0	1315,0	18	16466	4 G 70	46,1	3257,0	4600,0	2/0
16268	61 G 1	26,0	710,0	1370,0	18	16158	5 G 70	50,5	4032,0	5750,0	2/0
16269	80 G 1	30,0	940,0	1610,0	18	16467	4 G 95	51,1	4060,0	6060,0	3/0
16270	100 G 1	33,1	1180,0	1840,0	18	16159	5 G 95	56,0	5244,0	7580,0	3/0
16271	2 x 1,5	8,6	64,0	130,0	16	16468	4 G 120	56,5	5231,0	7315,0	4/0
16272	3 G 1,5	9,2	82,0	152,0	16	16160	5 G 120	62,1	6624,0	9150,0	4/0
16180	3 x 1,5	9,2	82,0	152,0	16	16167	4 G 150	64,6	7760,0	9680,0	300 kcmil
16273	4 G 1,5	9,8	99,0	168,0	16	16168	5 G 150	70,6	8496,0	10170,0	300 kcmil

Dimensions and specifications may be changed without prior notice. (RA01)

JZ-500 HMH

flexible control cable, halogen-free, extremely fire resistant¹⁾, oil resistant¹⁾, meter marking



Technical data

- Halogen-free flexible control cable adapted to
DIN VDE 0285-525-2-51 /
DIN EN 50525-2-51 and
DIN VDE 0285-525-3-11 /
DIN EN 50525-3-11
- **Temperature range**
flexing -15°C to +70°C
fixed installation -40°C to +70°C
- **Nominal voltage**
U₀/U 300/500 V
- **Test voltage**
2000 V
- **Minimum bending radius**
flexing 12,5x cable Ø
fixed installation 4x cable Ø
- **Radiation resistance**
up to 100x10⁶ cJ/kg (up to 100 Mrad)

Cable structure

- Bare copper conductor, to
DIN VDE 0295 cl.5, fine wire,
BS 6360 cl.5, IEC 60228 cl.5
- Core insulation of halogen-free polymer compound type T16 to
DIN VDE 0207-363-7 / DIN EN 50363-7
- Core identification to DIN VDE 0293
black cores with continuous white numbering
- GN-YE conductor, 3 cores and above in the outer layer
- Cores stranded in layers with optimal lay length
- Outer sheath of halogen-free polymer compound type TM7 to
DIN VDE 0207-363-8 / DIN EN 50363-8
- Outer Sheath colour: grey (RAL 7001)
- With meter marking
- **LS0H**= Low Smoke Zero Halogen

Properties

- ¹⁾ For the critical applications we advise for consultation
- The materials used during manufacturing are cadmium-free, contain no silicone and are free from substances harmful to the wetting properties of lacquers

Tests

- Flame test acc. to
DIN VDE 0482-332-3-24, BS 4066 part 3,
DIN EN 60332-3-24, IEC 60332-3-24
(previously DIN VDE 0472 part 804 test method C)
- Self-extinguishing and flame retardant acc. to DIN VDE 0482-332-1-2,
DIN EN 60332-1-2, IEC 60332-1-2
(equivalent DIN VDE 0472 part 804 test method B)
- Corrosiveness of combustion gases acc. to DIN VDE 0482-754-2,
DIN EN 60754-2, IEC 60754-2
(previously DIN VDE 0482-267-2-2)
- Halogen-free acc. to
DIN VDE 0482-754-1,
DIN EN 60754-1, IEC 60754-1
(previously DIN VDE 0482-267-2-1)
- Smoke density acc. to DIN VDE 0482 part 1034-1+2, DIN EN 61034-1+2,
IEC 61034-1+2, BS 7622 part 1+2

Note

- G = with GN-YE conductor
x = without GN-YE conductor (OZ)
- AWG sizes are approximate equivalent values. The actual cross section is in mm².
- Please note "cleanroom qualified" when ordering.
- Screened analogue type:
JZ-500 HMH-C

Application

Used as measuring, monitoring and control cables in tool machinery, conveyor belts, production lines, in plant, in air-conditioning, in foundries and steel mills. For fixed installation or flexible application, casual, not constantly recurring free movement without forced motion and without tensile stress, for medium mechanical stress. The cable is suitable for use in dry, damp and wet locations and on plaster.

CE = Product conforms with Low-Voltage Directive 2014/35/EU.

Part no.	No. cores x cross-sec. mm ²	Outer Ø app. mm	Cop. weight kg / km	Weight app. kg / km	AWG-No.
11201	2 x 0,5	4,8	9,6	43,0	20
11202	3 G 0,5	5,1	14,4	50,0	20
11332	3 x 0,5	5,1	14,4	50,0	20
11203	4 G 0,5	5,6	19,0	60,0	20
11333	4 x 0,5	5,5	19,0	60,0	20
11204	5 G 0,5	6,2	24,0	71,0	20
11334	5 x 0,5	6,2	24,0	71,0	20
11205	7 G 0,5	6,7	33,6	84,0	20
11206	8 G 0,5	7,4	38,0	101,0	20
11207	10 G 0,5	8,3	48,0	121,0	20
11208	12 G 0,5	8,7	58,0	142,0	20
11209	16 G 0,5	10,0	76,0	183,0	20

Part no.	No. cores x cross-sec. mm ²	Outer Ø app. mm	Cop. weight kg / km	Weight app. kg / km	AWG-No.
11210	18 G 0,5	10,7	86,0	204,0	20
11211	20 G 0,5	11,3	96,0	227,0	20
11212	25 G 0,5	12,6	120,0	283,0	20
11213	30 G 0,5	13,5	144,0	324,0	20
11214	34 G 0,5	14,3	163,0	367,0	20
11215	37 G 0,5	14,5	178,0	381,0	20
11216	41 G 0,5	15,8	197,0	417,0	20
11217	42 G 0,5	15,8	202,0	454,0	20
11218	50 G 0,5	17,5	240,0	519,0	20
11219	61 G 0,5	18,5	293,0	635,0	20
11220	65 G 0,5	19,4	312,0	694,0	20

Continuation ▶

JZ-500 HMH

flexible control cable, halogen-free, extremely fire resistant, oil resistant¹⁾, meter marking



Part no.	No. cores x cross-sec. mm ²	Outer Ø app. mm	Cop. weight kg / km	Weight app. kg / km	AWG-No.	Part no.	No. cores x cross-sec. mm ²	Outer Ø app. mm	Cop. weight kg / km	Weight app. kg / km	AWG-No.
11221	2 x 0,75	5,3	14,4	47,0	19	11277	2 x 2,5	7,8	48,0	118,0	14
11222	3 G 0,75	5,6	21,6	56,0	19	11278	3 G 2,5	8,3	72,0	151,0	14
11335	3 x 0,75	5,6	21,6	56,0	19	11279	4 G 2,5	9,2	96,0	181,0	14
11223	4 G 0,75	6,3	29,0	69,0	19	11280	5 G 2,5	10,1	120,0	224,0	14
11336	4 x 0,75	6,3	29,0	69,0	19	11281	7 G 2,5	11,2	168,0	316,0	14
11224	5 G 0,75	6,9	36,0	83,0	19	11282	8 G 2,5	12,3	192,0	370,0	14
11337	5 x 0,75	6,9	36,0	83,0	19	11283	10 G 2,5	14,0	240,0	451,0	14
11225	7 G 0,75	7,5	50,0	114,0	19	11284	12 G 2,5	14,8	288,0	499,0	14
11338	7 x 0,75	7,5	50,0	114,0	19	11285	16 G 2,5	17,1	384,0	720,0	14
11226	8 G 0,75	8,3	58,0	136,0	19	11286	18 G 2,5	18,2	432,0	769,0	14
11227	10 G 0,75	9,2	72,0	172,0	19	11287	20 G 2,5	19,2	480,0	911,0	14
11228	12 G 0,75	9,8	86,0	183,0	19	11288	25 G 2,5	21,6	600,0	1047,0	14
11229	16 G 0,75	11,4	115,0	241,0	19	11289	30 G 2,5	23,0	720,0	1280,0	14
11230	18 G 0,75	12,2	130,0	266,0	19	11290	2 x 4	9,3	77,0	199,0	12
11231	20 G 0,75	12,7	144,0	291,0	19	11291	3 G 4	9,8	115,0	247,0	12
11232	25 G 0,75	14,3	180,0	374,0	19	11292	4 G 4	10,9	154,0	299,0	12
11233	30 G 0,75	15,3	216,0	450,0	19	11293	5 G 4	12,1	192,0	369,0	12
11234	34 G 0,75	16,5	245,0	517,0	19	11294	7 G 4	13,2	269,0	463,0	12
11235	37 G 0,75	16,7	260,0	541,0	19	11295	8 G 4	14,7	307,0	601,0	12
11236	41 G 0,75	18,1	296,0	611,0	19	11296	10 G 4	17,5	384,0	698,0	12
11237	42 G 0,75	18,1	302,0	621,0	19	11297	12 G 4	17,7	461,0	790,0	12
11238	50 G 0,75	19,8	360,0	742,0	19	11298	16 G 4	20,3	614,0	1130,0	12
11239	61 G 0,75	21,2	439,0	853,0	19	11299	18 G 4	21,6	691,0	1280,0	12
11240	65 G 0,75	21,8	468,0	909,0	19	11300	2 x 6	11,0	115,0	266,0	10
11241	2 x 1	5,6	19,2	63,0	18	11301	3 G 6	11,9	173,0	360,0	10
11242	3 G 1	5,9	29,0	74,0	18	11302	4 G 6	13,0	230,0	429,0	10
11339	3 x 1	5,9	29,0	74,0	18	11303	5 G 6	14,5	288,0	529,0	10
11243	4 G 1	6,6	38,4	90,0	18	11304	7 G 6	16,2	403,0	631,0	10
11340	4 x 1	6,6	38,4	90,0	18	11305	2 x 10	13,8	192,0	440,0	8
11244	5 G 1	7,3	48,0	109,0	18	11306	3 G 10	14,9	288,0	550,0	8
11245	7 G 1	8,1	67,0	151,0	18	11307	4 G 10	16,5	384,0	708,0	8
11246	8 G 1	8,8	77,0	184,0	18	11308	5 G 10	18,3	480,0	862,0	8
11247	10 G 1	9,8	96,0	224,0	18	11309	7 G 10	20,2	672,0	1124,0	8
11248	12 G 1	10,4	115,0	243,0	18	11310	2 x 16	16,8	307,0	642,0	6
11249	16 G 1	12,3	154,0	314,0	18	11311	3 G 16	18,3	461,0	830,0	6
11250	18 G 1	12,9	173,0	361,0	18	11312	4 G 16	20,1	614,0	1060,0	6
11251	20 G 1	13,8	192,0	387,0	18	11313	5 G 16	22,6	768,0	1270,0	6
11252	25 G 1	15,4	240,0	496,0	18	11314	7 G 16	24,8	1075,0	1794,0	6
11253	34 G 1	17,7	326,0	670,0	18	11315	3 G 25	22,3	720,0	1190,0	4
11254	37 G 1	17,9	355,0	713,0	18	11316	4 G 25	25,0	960,0	1594,0	4
11255	41 G 1	19,5	394,0	784,0	18	11317	5 G 25	27,7	1200,0	2014,0	4
11256	42 G 1	19,5	403,0	824,0	18	11318	3 G 35	25,9	1008,0	1590,0	2
11257	50 G 1	21,3	480,0	952,0	18	11319	4 G 35	28,7	1344,0	2200,0	2
11258	61 G 1	22,5	586,0	1140,0	18	11320	5 G 35	31,9	1680,0	2693,0	2
11259	65 G 1	23,6	628,0	1201,0	18	11321	3 G 50	30,8	1440,0	2571,0	1
11260	2 x 1,5	6,4	29,0	70,0	16	11322	4 G 50	34,1	1920,0	3087,0	1
11261	3 G 1,5	6,8	43,0	94,0	16	11323	5 G 50	38,1	2400,0	3980,0	1
11341	3 x 1,5	6,8	43,0	94,0	16	11324	3 G 70	36,4	2016,0	3207,0	2/0
11262	4 G 1,5	7,4	58,0	112,0	16	11325	4 G 70	40,2	2688,0	4077,0	2/0
11263	5 G 1,5	8,3	72,0	141,0	16	11326	5 G 70	44,7	3360,0	5501,0	2/0
11264	7 G 1,5	9,2	101,0	191,0	16	11327	3 G 95	41,3	2736,0	4708,0	3/0
11265	8 G 1,5	10,0	115,0	224,0	16	11328	4 G 95	46,0	3648,0	5590,0	3/0
11266	10 G 1,5	10,9	144,0	282,0	16	11329	5 G 95	50,7	4560,0	6972,0	3/0
11267	12 G 1,5	11,8	173,0	311,0	16	11330	3 G 120	47,0	3456,0	5515,0	4/0
11268	16 G 1,5	13,9	230,0	392,0	16	11331	4 G 120	51,0	4608,0	7100,0	4/0
11269	18 G 1,5	14,6	259,0	450,0	16						
11270	20 G 1,5	15,6	288,0	497,0	16						
11271	25 G 1,5	17,4	360,0	630,0	16						
11272	34 G 1,5	20,2	490,0	842,0	16						
11273	37 G 1,5	20,2	533,0	897,0	16						
11274	50 G 1,5	24,2	720,0	1277,0	16						
11275	61 G 1,5	25,8	878,0	1460,0	16						
11276	65 G 1,5	26,8	936,0	1612,0	16						

Dimensions and specifications may be changed without prior notice. (RA03)

JZ-500 HMH-C

flexible control cable, halogen-free, extremely fire resistant, oil resistant¹⁾,
Cu-screened, EMC-preferred type, meter marking



Technical data

- Halogen-free core flexible control cable adapted to DIN VDE 0285-525-2-51 / DIN EN 50525-2-51 and DIN VDE 0285-525-3-11 / DIN EN 50525-3-11
- **Temperature range**
flexing -15°C to +70°C
fixed installation -40°C to +70°C
- **Nominal voltage**
U₀/U 300/500 V
- **Test voltage**
2000 V
- **Coupling resistance**
max. 250 Ohm/km
- **Minimum bending radius**
flexing 12,5x cable Ø
fixed installation 4x cable Ø
- **Radiation resistance**
up to 100x10⁶ cJ/kg (up to 100 Mrad)

Cable structure

- Bare copper conductor, to DIN VDE 0295 cl.5, fine wire, BS 6360 cl.5, IEC 60228 cl.5
- Core insulation of halogen-free polymer compound type T16 to DIN VDE 0207-363-7 / DIN EN 50363-7
- Core identification to DIN VDE 0293 black cores with continuous white numbering
- GN-YE conductor, 3 cores and above in the outer layer
- Cores stranded in layers with optimal lay length
- Separating foil
- Tinned copper braided screen, approx. 85% coverage
- Outer sheath of halogen-free polymer compound type TM7 to DIN VDE 0207-363-8 / DIN EN 50363-8
- Sheath colour: grey (RAL 7001)
- With meter marking
- **LSOH**= Low Smoke Zero Halogen

Properties

- ¹⁾We recommend you for critical applications a consultation
- The materials used during manufacturing are cadmium-free, contain no silicone and are free from substances harmful to the wetting properties of lacquers

Tests

- Flame test acc. to DIN VDE 0482-332-3-24, BS 4066 part 3, DIN EN 60332-3-24, IEC 60332-3-24 (previously DIN VDE 0472 part 804 test method C)
- Self-extinguishing and flame retardant acc. to DIN VDE 0482-332-1-2, DIN EN 60332-1-2, IEC 60332-1-2 (equivalent DIN VDE 0472 part 804 test method B)
- Corrosiveness of combustion gases acc. to DIN VDE 0482-754-2, DIN EN 60754-2, IEC 60754-2 (previously DIN VDE 0482-267-2-2)
- Halogen-free acc. to DIN VDE 0482-754-1, DIN EN 60754-1, IEC 60754-1 (previously DIN VDE 0482-267-2-1)
- Smoke density acc. to DIN VDE 0482 part 1034-1+2, DIN EN 61034-1+2, IEC 61034-1+2, BS 7622 part 1+2

Note

- G = with GN-YE conductor
x = without GN-YE conductor (OZ)
- Cleanroom qualification tested with analog type. Please note "cleanroom qualified" when ordering.
- AWG sizes are approximate equivalent values. The actual cross section is in mm².
- Unscreened analogue type:

JZ-500 HMH

Application

Halogen-free, flame retardant control cables are used for instrumentation and control cables in tooling machinery, conveyor and transportation belts, production lines, in plant construction, air-conditioning systems as well as in iron and steel works. For fixed installation or for flexing applications, for casual, not constantly recurring free movement without forced motion and without tensile stress for medium mechanical loads. The cable is suitable for use in dry, damp and wet environments and on plaster. An interference-free transmission of signals and pulse is assured by the high degree of screening.

EMC = Electromagnetic compatibility

To optimize the EMC features we recommend a large round contact of the copper braiding on both ends.

= Product conforms with Low-Voltage Directive 2014/35/EU.

Part no.	No. cores x cross-sec. mm ²	Outer Ø app. mm	Cop. weight kg / km	Weight app. kg / km	AWG-No.
11656	2 x 0,5	5,7	35,0	46,0	20
11657	3 G 0,5	5,9	42,0	56,0	20
11342	3 x 0,5	5,9	42,0	56,0	20
11658	4 G 0,5	6,4	47,0	62,0	20
11343	4 x 0,5	6,4	47,0	62,0	20

Part no.	No. cores x cross-sec. mm ²	Outer Ø app. mm	Cop. weight kg / km	Weight app. kg / km	AWG-No.
11659	5 G 0,5	6,9	56,0	75,0	20
11660	7 G 0,5	7,6	69,0	98,0	20
11663	12 G 0,5	9,7	108,0	158,0	20
11665	18 G 0,5	11,5	145,0	216,0	20
11667	25 G 0,5	13,7	240,0	315,0	20

Continuation ▶

JZ-500 HMH-C

flexible control cable, halogen-free, extremely fire resistant, oil resistant¹⁾,
Cu-screened, EMC-preferred type, meter marking



Part no.	No. cores x cross-sec. mm ²	Outer Ø app. mm	Cop. weight kg / km	Weight app. kg / km	AWG-No.	Part no.	No. cores x cross-sec. mm ²	Outer Ø app. mm	Cop. weight kg / km	Weight app. kg / km	AWG-No.
11678	2 x 0,75	6,1	40,0	60,0	19	11766	2 x 4	10,0	120,0	184,0	12
11679	3 G 0,75	6,3	52,0	68,0	19	11768	3 G 4	10,6	174,0	238,0	12
11344	3 x 0,75	6,3	52,0	68,0	19	11769	4 G 4	11,6	230,0	305,0	12
11680	4 G 0,75	6,8	60,0	78,0	19	11770	5 G 4	12,8	273,0	388,0	12
11345	4 x 0,75	6,8	60,0	78,0	19	11771	7 G 4	14,2	316,0	504,0	12
11681	5 G 0,75	7,4	71,0	95,0	19	11781	2 G 6	11,7	173,0	270,0	10
11346	5 x 0,75	7,4	71,0	95,0	19	11782	3 G 6	12,5	240,0	328,0	10
11682	7 G 0,75	8,2	91,0	130,0	19	11783	4 G 6	13,8	305,0	416,0	10
11347	7 x 0,75	8,2	91,0	130,0	19	11784	5 G 6	15,4	439,0	510,0	10
11685	12 G 0,75	10,5	142,0	203,0	19	11785	7 G 6	17,0	505,0	670,0	10
11687	18 G 0,75	12,7	212,0	290,0	19	11786	2 x 10	14,5	255,0	420,0	8
11689	25 G 0,75	15,0	281,0	413,0	19	11787	3 G 10	15,6	350,0	495,0	8
11700	2 x 1	6,4	50,0	66,0	18	11788	4 G 10	17,2	535,0	785,0	8
11701	3 G 1	6,7	60,0	80,0	18	11789	5 G 10	19,1	592,0	855,0	8
11348	3 x 1	6,7	60,0	80,0	18	11790	7 G 10	21,2	810,0	1308,0	8
11702	4 G 1	7,2	71,0	100,0	18	11793	4 G 16	20,3	740,0	882,0	6
11349	4 x 1	7,2	71,0	100,0	18	11794	5 G 16	22,2	895,0	1293,0	6
11703	5 G 1	8,0	88,0	130,0	18	11812	7 G 16	24,8	1282,0	2149,0	6
11704	7 G 1	8,7	111,0	160,0	18	11795	3 G 25	22,5	1070,0	1432,0	4
11707	12 G 1	11,4	184,0	260,0	18	11796	4 G 25	25,0	1140,0	1911,0	4
11709	18 G 1	13,6	260,0	382,0	18	11797	5 G 25	27,5	1380,0	2414,0	4
11711	25 G 1	16,2	349,0	540,0	18	11798	3 G 35	25,7	1240,0	1914,0	2
11722	2 x 1,5	7,0	63,0	88,0	16	11799	4 G 35	28,5	1576,0	2542,0	2
11723	3 G 1,5	7,4	80,0	100,0	16	11800	5 G 35	31,7	1930,0	3180,0	2
11350	3 x 1,5	7,4	80,0	100,0	16	11801	3 G 50	30,8	1675,0	3080,0	1
11724	4 G 1,5	8,1	97,0	125,0	16	11802	4 G 50	34,1	2155,0	3550,0	1
11725	5 G 1,5	9,0	119,0	158,0	16	11803	5 G 50	38,1	2794,0	4753,0	1
11726	7 G 1,5	9,8	147,0	210,0	16	11804	3 G 70	36,0	2288,0	3840,0	2/0
11729	12 G 1,5	12,8	267,0	340,0	16	11805	4 G 70	40,0	3120,0	4939,0	2/0
11731	18 G 1,5	15,6	374,0	480,0	16	11806	5 G 70	44,5	3705,0	6572,0	2/0
11733	25 G 1,5	18,4	526,0	702,0	16	11807	3 G 95	41,1	3010,0	5651,0	3/0
11744	2 x 2,5	8,4	96,0	132,0	14	11808	4 G 95	45,6	4043,0	6690,0	3/0
11745	3 G 2,5	8,8	144,0	168,0	14	11809	5 G 95	50,7	5026,0	8370,0	3/0
11746	4 G 2,5	9,8	148,0	195,0	14	11810	3 G 120	45,2	3812,0	6342,0	4/0
11747	5 G 2,5	10,8	181,0	222,0	14	11811	4 G 120	50,1	5069,0	8453,0	4/0
11748	7 G 2,5	11,9	255,0	345,0	14	11813	4 G 185	63,0	8040,0	10800,0	350 kcmil
11751	12 G 2,5	15,8	441,0	572,0	14						

Dimensions and specifications may be changed without prior notice. (RA03)

MEGAFLEX® 500

halogen-free, flame retardant, oil resistant, UV resistant, flexible, meter marking



Technical data

- Halogen-free flexible control cable adapted to
DIN VDE 0285-525-3-11 /
DIN EN 50525-3-11,
to UL Style 20939, UL Std.758
- **Temperature range**
flexing -30°C to +80°C
fixed installation -40°C to +80°C
- **Nominal voltage**
U₀/U 300/500 V
UL/CSA 600 V
- **Test voltage** 3000 V
- **Minimum bending radius**
flexing 10x cable Ø
fixed installation 4x cable Ø
- **Flexibility**
Alternate bending test acc. to
DIN VDE 0473-396 / DIN EN 50396

Cable structure

- Bare copper conductor, to
DIN VDE 0295 cl.5, fine wire,
BS 6360 cl.5, IEC 60228 cl.5
- Core insulation of halogen free
special polymer
- Core identification to DIN VDE 0293
black cores with continuous white
numbering
- GN-YE conductor, 3 cores and above
in the outer layer
- Cores stranded in layers with
optimal lay length
- Outer sheath of halogen-free
special polymer
- Sheath colour: grey (RAL 7001)
- With meter marking
- **LSOH**= Low Smoke Zero Halogen

Note

- G = with GN-YE conductor
x = without GN-YE conductor (OZ)
- Also available as a 0,6/1 kV cable
MEGAFLEX® 600
- AWG sizes are approximate equivalent
values. The actual cross section is in mm².
- Screened analogue type:

MEGAFLEX® 500-C

Properties

- Highly flame retardant
- Resistant to oils and greases
- Resistant to UV and weathering
- Hydrolysis resistant
- Flexible, abrasion- and wear-resistant
- Ozone-resistant, recyclable
- The materials used during manufacturing
are cadmium-free, contain no silicone
and are free from substances harmful
to the wetting properties of lacquers

Tests

- Flame test acc. to DIN VDE 0482-332-3-24,
BS 4066 part 3, DIN EN 60332-3-24,
IEC 60332-3-24 (previously DIN VDE 0472
part 804 test method C)
- Self-extinguishing and flame retardant
acc. to DIN VDE 0482-332-1-2,
DIN EN 60332-1-2, IEC 60332-1-2
(equivalent DIN VDE 0472 part 804
test method B), CSA FT1
- Corrosiveness of combustion gases
acc. to NF X 10-702
- Halogen-free acc. to
DIN VDE 0482-754-1,
DIN EN 60754-1, IEC 60754-1
(previously DIN VDE 0482-267-2-1)
- Smoke density acc. to DIN VDE 0482
part 1034-1+2, DIN EN 61034-1+2,
IEC 61034-1+2, BS 7622 part 1+2
- Oil resistant to DIN VDE 0473-811-404/
DIN EN 60811-404
- Hydrolysis resistant to DIN EN 61234-1
- Ozone resistant to
DIN VDE 0473-811-403/DIN EN 60811-403

Application

For fixed installation or flexible application, with free movements without forcing which do not constantly recur and without tensile stress, for high mechanical strain. As a measuring and control cable primarily in machinery and plant construction, in air-conditioning systems, at the warehouse and conveyor systems, in ship-building and in the renewable energies such as in the construction of wind power stations.

CE = Product conforms with Low-Voltage Directive 2014/35/EU.

Part no.	No. cores x cross-sec. mm ²	AWG-No.	Outer Ø app. mm	Cop. weight kg / km	Weight app. kg / km
13344	2 x 0,5	20	5,0	9,6	43,0
13345	3 G 0,5	20	5,3	14,4	50,0
13346	3 x 0,5	20	5,3	14,4	50,0
13347	4 G 0,5	20	5,7	19,0	60,0
13348	4 x 0,5	20	5,7	19,0	60,0
13349	5 G 0,5	20	6,2	24,0	71,0
13350	5 x 0,5	20	6,2	24,0	71,0
13351	7 G 0,5	20	7,4	33,6	84,0

Part no.	No. cores x cross-sec. mm ²	AWG-No.	Outer Ø app. mm	Cop. weight kg / km	Weight app. kg / km
13352	8 G 0,5	20	8,0	38,0	101,0
13353	10 G 0,5	20	8,8	48,0	121,0
13354	12 G 0,5	20	9,1	58,0	142,0
13355	16 G 0,5	20	10,0	76,0	183,0
13356	18 G 0,5	20	10,7	86,0	204,0
13357	20 G 0,5	20	11,2	96,0	227,0
13359	25 G 0,5	20	12,7	120,0	283,0
13360	30 G 0,5	20	13,5	144,0	324,0

Continuation ▶

MEGAFLEX® 500

halogen-free, flame retardant, oil resistant, UV resistant, flexible, meter marking



Part no.	No. cores x cross-sec. mm ²	AWG-No.	Outer Ø app. mm	Cop. weight kg / km	Weight app. kg / km
13361	34 G 0,5	20	14,5	163,0	367,0
13362	37 G 0,5	20	14,5	178,0	381,0
13363	41 G 0,5	20	15,8	197,0	417,0
13364	42 G 0,5	20	15,8	202,0	454,0
13365	50 G 0,5	20	17,3	240,0	519,0
13366	61 G 0,5	20	18,5	293,0	635,0
13367	65 G 0,5	20	19,4	312,0	694,0
13368	2 x 0,75	19	5,4	14,4	47,0
13369	3 G 0,75	19	5,7	21,6	56,0
13370	3 x 0,75	19	5,7	21,6	56,0
13371	4 G 0,75	19	6,2	29,0	69,0
13372	4 x 0,75	19	6,2	29,0	69,0
13373	5 G 0,75	19	6,8	36,0	83,0
13374	5 x 0,75	19	6,8	36,0	83,0
13375	7 G 0,75	19	8,1	50,0	114,0
13376	7 x 0,75	19	8,1	50,0	114,0
13377	8 G 0,75	19	8,9	58,0	136,0
13378	10 G 0,75	19	9,6	72,0	172,0
13379	12 G 0,75	19	9,9	86,0	183,0
13380	16 G 0,75	19	11,2	115,0	241,0
13381	18 G 0,75	19	11,9	130,0	266,0
13382	20 G 0,75	19	12,6	144,0	291,0
13383	25 G 0,75	19	14,1	180,0	374,0
13384	30 G 0,75	19	15,4	216,0	450,0
13385	34 G 0,75	19	16,4	245,0	517,0
13386	37 G 0,75	19	16,4	260,0	541,0
13387	41 G 0,75	19	17,6	296,0	611,0
13388	42 G 0,75	19	17,6	302,0	621,0
13389	50 G 0,75	19	19,8	360,0	742,0
13390	61 G 0,75	19	20,9	439,0	853,0
13392	65 G 0,75	19	21,8	468,0	909,0
13393	2 x 1	18	5,7	19,2	63,0
13394	3 G 1	18	6,0	29,0	74,0
13395	3 x 1	18	6,0	29,0	74,0
13396	4 G 1	18	6,6	38,4	90,0
13397	4 x 1	18	6,6	38,4	90,0
13398	5 G 1	18	7,2	48,0	109,0
13399	7 G 1	18	8,6	67,0	151,0
13400	8 G 1	18	9,4	77,0	184,0
13401	10 G 1	18	10,4	96,0	224,0
13402	12 G 1	18	10,7	115,0	243,0
13403	16 G 1	18	12,0	154,0	314,0
13404	18 G 1	18	12,7	173,0	361,0
13405	20 G 1	18	13,5	192,0	387,0
13406	25 G 1	18	15,2	240,0	496,0
13407	34 G 1	18	17,4	326,0	670,0
13408	37 G 1	18	17,4	355,0	713,0
13409	41 G 1	18	18,9	394,0	784,0
13410	42 G 1	18	18,9	403,0	824,0
13411	50 G 1	18	21,0	480,0	952,0
13412	61 G 1	18	22,2	586,0	1140,0
13413	65 G 1	18	23,2	628,0	1201,0
13414	2 x 1,5	16	6,3	29,0	70,0
13415	3 G 1,5	16	6,6	43,0	94,0
13416	3 x 1,5	16	6,6	43,0	94,0
13417	4 G 1,5	16	7,2	58,0	112,0
13418	5 G 1,5	16	7,9	72,0	141,0
13419	7 G 1,5	16	9,5	101,0	191,0
13420	8 G 1,5	16	10,4	115,0	224,0
13421	10 G 1,5	16	11,3	144,0	282,0
13422	12 G 1,5	16	11,7	173,0	311,0
13423	16 G 1,5	16	13,3	230,0	392,0
13425	18 G 1,5	16	14,0	259,0	450,0
13426	20 G 1,5	16	14,9	288,0	497,0

Part no.	No. cores x cross-sec. mm ²	AWG-No.	Outer Ø app. mm	Cop. weight kg / km	Weight app. kg / km
13427	25 G 1,5	16	16,8	360,0	630,0
13428	34 G 1,5	16	19,4	490,0	842,0
13429	37 G 1,5	16	19,4	533,0	897,0
13430	50 G 1,5	16	23,4	720,0	1277,0
13431	61 G 1,5	16	24,8	878,0	1460,0
13432	65 G 1,5	16	25,8	936,0	1612,0
13433	2 x 2,5	14	7,6	48,0	118,0
13434	3 G 2,5	14	8,3	72,0	151,0
13435	4 G 2,5	14	9,1	96,0	181,0
13436	5 G 2,5	14	10,2	120,0	224,0
13437	7 G 2,5	14	12,1	168,0	316,0
13438	8 G 2,5	14	13,2	192,0	370,0
13439	10 G 2,5	14	14,6	240,0	451,0
13440	12 G 2,5	14	15,2	288,0	499,0
13441	16 G 2,5	14	16,8	384,0	720,0
13442	18 G 2,5	14	18,1	432,0	769,0
13443	20 G 2,5	14	19,0	480,0	911,0
13444	25 G 2,5	14	22,2	600,0	1047,0
13445	30 G 2,5	14	22,9	720,0	1280,0
13446	2 x 4	12	9,2	77,0	199,0
13447	3 G 4	12	9,9	115,0	247,0
13448	4 G 4	12	11,0	154,0	299,0
13449	5 G 4	12	12,1	192,0	369,0
13450	7 G 4	12	13,3	269,0	463,0
13451	8 G 4	12	15,9	307,0	601,0
13452	10 G 4	12	17,3	384,0	698,0
13453	12 G 4	12	18,3	461,0	790,0
13454	16 G 4	12	20,2	614,0	1130,0
13455	18 G 4	12	21,8	691,0	1280,0
13456	2 x 6	10	10,8	115,0	266,0
13457	3 G 6	10	11,7	173,0	360,0
13458	4 G 6	10	13,0	230,0	429,0
13459	5 G 6	10	14,5	288,0	529,0
13460	7 G 6	10	16,0	403,0	631,0
13461	2 x 10	8	14,0	192,0	440,0
13462	3 G 10	8	15,0	288,0	550,0
13463	4 G 10	8	16,8	384,0	708,0
13464	5 G 10	8	18,7	480,0	862,0
13465	7 G 10	8	20,6	672,0	1124,0
13466	2 x 16	6	16,5	307,0	642,0
13467	3 G 16	6	17,6	461,0	830,0
13468	4 G 16	6	19,7	641,0	1060,0
13469	5 G 16	6	21,9	768,0	1270,0
13470	7 G 16	6	24,4	1075,0	1794,0
13471	3 G 25	4	22,5	720,0	1190,0
13472	4 G 25	4	25,2	960,0	1594,0
13473	5 G 25	4	27,9	1200,0	2014,0
13474	3 G 35	2	26,3	1008,0	1590,0
13475	4 G 35	2	28,5	1344,0	2200,0
13476	5 G 35	2	31,2	1680,0	2693,0
13477	3 G 50	1	30,2	1440,0	2571,0
13478	4 G 50	1	34,0	1920,0	3087,0
13479	5 G 50	1	37,8	2400,0	3980,0
13480	3 G 70	2/0	37,0	2016,0	3207,0
13481	4 G 70	2/0	41,5	2688,0	4077,0
13482	5 G 70	2/0	46,2	3360,0	5501,0
13483	3 G 95	3/0	41,4	2736,0	4708,0
13484	4 G 95	3/0	46,2	3648,0	5590,0
13485	5 G 95	3/0	51,5	4560,0	6972,0
13486	3 G 120	4/0	45,7	3456,0	5515,0
13487	4 G 120	4/0	51,2	4608,0	7100,0
13488	3 G 150	300 kcmil	52,8	4320,0	6279,0
13489	4 G 150	300 kcmil	58,3	5760,0	7781,0

Dimensions and specifications may be changed without prior notice. (RA03)

MEGAFLEX® 500-C

halogen-free, flame retardant, oil resistant, UV resistant, flexible, screened,
EMC-preferred types, meter marking



Technical data

- Halogen-free flexible control cable adapted to
DIN VDE 0285-525-3-11 /
DIN EN 50525-3-11,
to UL Style 20939, UL Std.758
- **Temperature range**
flexing -30°C to +80°C
fixed installation -40°C to +80°C
- **Nominal voltage**
U₀/U 300/500 V
UL/CSA 600 V
- **Test voltage**
3000 V
- **Coupling resistance**
max. 250 Ohm/km
- **Minimum bending radius**
flexing 10x cable Ø
fixed installation 4x cable Ø
- **Flexibility**
Alternate bending test acc. to
DIN VDE 0473-396 / DIN EN 50396

Cable structure

- Bare copper, fine wire conductor, to
DIN VDE 0295 cl.5, BS 6360 cl.5 and
IEC 60228 cl.5
- Core insulation of halogen-free
special polymer
- Core identification to DIN VDE 0293
black cores with continuous white
numbering
- GN-YE conductor, 3 cores and above
in the outer layer
- Cores stranded in layers with
optimal lay length
- Separating foil
- Tinned copper braided screen,
approx. 85% coverage
- Outer sheath of halogen-free
special polymer
- Sheath colour: grey (RAL 7001)
- With meter marking
- **LSOH**= Low Smoke Zero Halogen

Note

- G = with GN-YE conductor
x = without GN-YE conductor (OZ)
- AWG sizes are approximate equivalent
values. The actual cross section is in mm².
- Unscreened analogue type:
MEGAFLEX® 500

Properties

- Halogen-free
- Highly flame retardant
- Resistant to oils and greases
- Resistant to UV and weathering
- Flexible, abrasion and wear resistant
- Ozone-resistant
- Recycleable
- The materials used during manufacturing
are cadmium-free, contain no silicone
and are free from substances harmful
to the wetting properties of lacquers

Tests

- Flame test acc. to DIN VDE 0482-332-3-24,
BS 4066 part 3, DIN EN 60332-3-24,
IEC 60332-3-24 (previously DIN VDE 0472
part 804 test method C)
- Self-extinguishing and flame retardant
acc. to DIN VDE 0482-332-1-2,
DIN EN 60332-1-2, IEC 60332-1-2
(equivalent DIN VDE 0472 part 804
test method B), CSA FT1
- Corrosiveness of combustion gases acc. to
NF X 10-702
- Halogen-free acc. to
DIN VDE 0482-754-1,
DIN EN 60754-1, IEC 60754-1
(previously DIN VDE 0482-267-2-1)
- Smoke density acc. to DIN VDE 0482
part 1034-1+2, DIN EN 61034-1+2,
IEC 61034-1+2, BS 7622 part 1+2
- Oil resistant to DIN VDE 0473-811-404 /
DIN EN 60811-404
- Hydrolysis resistant to DIN EN 61234-1
- Ozone resistant to DIN VDE 0473-811-403/
DIN EN 60811-403

Application

For fixed installation or flexible application that does not permanently recurring free movement without forced motion and without tensile stress, for high mechanical strain. As a measuring and control cable e. g. in machine and plant engineering, air conditioning in the warehouse and materials handling, shipbuilding and in the newable energies such as wind power stations.

EMC = Electromagnetic compatibility

To optimize the EMC features we recommend a large round contact of the copper braiding on both ends.

= Product conforms with Low-Voltage Directive 2014/35/EU.

Part no.	No. cores x cross-sec. mm ²	AWG-No.	Outer Ø app. mm	Cop. weight kg / km	Weight app. kg / km
13500	2 x 0,5	20	5,7	35,0	46,0
13501	3 G 0,5	20	6,0	42,0	56,0
13502	3 x 0,5	20	6,0	42,0	56,0
13503	4 G 0,5	20	6,5	47,0	62,0
13504	4 x 0,5	20	6,5	47,0	62,0
13505	5 G 0,5	20	7,0	56,0	75,0
13506	5 x 0,5	20	7,0	56,0	75,0
13507	7 G 0,5	20	7,9	69,0	98,0

Part no.	No. cores x cross-sec. mm ²	AWG-No.	Outer Ø app. mm	Cop. weight kg / km	Weight app. kg / km
13508	8 G 0,5	20	8,5	80,0	116,0
13509	10 G 0,5	20	9,3	94,0	135,0
13510	12 G 0,5	20	9,6	108,0	158,0
13511	16 G 0,5	20	10,7	129,0	210,0
13512	18 G 0,5	20	11,2	145,0	216,0
13514	20 G 0,5	20	11,9	172,0	240,0
13515	25 G 0,5	20	13,4	240,0	315,0

Continuation ▶

MEGAFLEX® 500-C

halogen-free, flame retardant, oil resistant, UV resistant, flexible, screened,
EMC-preferred types, meter marking



Part no.	No. cores x cross-sec. mm ²	AWG-No.	Outer Ø app. mm	Cop. weight kg / km	Weight app. kg / km
13516	2 x 0,75	19	6,1	40,0	60,0
13517	3 G 0,75	19	6,4	52,0	68,0
13518	3 x 0,75	19	6,4	52,0	68,0
13519	4 G 0,75	19	6,9	60,0	78,0
13520	4 x 0,75	19	6,9	60,0	78,0
13521	5 G 0,75	19	7,4	71,0	95,0
13522	5 x 0,75	19	7,4	71,0	95,0
13523	7 G 0,75	19	8,6	91,0	130,0
13524	7 x 0,75	19	8,6	91,0	130,0
13525	8 G 0,75	19	9,4	110,0	145,0
13526	10 G 0,75	19	10,2	137,0	180,0
13527	12 G 0,75	19	10,4	142,0	203,0
13528	16 G 0,75	19	11,6	200,0	275,0
13529	18 G 0,75	19	12,4	212,0	290,0
13530	20 G 0,75	19	12,9	238,0	320,0
13531	25 G 0,75	19	14,8	281,0	413,0
13532	2 x 1	18	6,4	50,0	66,0
13533	3 G 1	18	6,7	60,0	80,0
13534	3 x 1	18	6,7	60,0	80,0
13535	4 G 1	18	7,3	71,0	100,0
13536	4 x 1	18	7,3	71,0	100,0
13537	5 G 1	18	7,8	88,0	130,0
13538	7 G 1	18	9,1	111,0	160,0
13539	8 G 1	18	9,9	127,0	197,0
13540	10 G 1	18	10,8	150,0	232,0
13541	12 G 1	18	11,2	184,0	260,0
13542	16 G 1	18	12,3	209,0	346,0
13543	18 G 1	18	13,2	260,0	382,0
13544	20 G 1	18	13,8	317,0	440,0
13545	25 G 1	18	15,8	349,0	540,0
13546	2 x 1,5	16	7,0	63,0	88,0
13547	3 G 1,5	16	7,3	80,0	100,0
13548	3 x 1,5	16	7,3	80,0	100,0
13549	4 G 1,5	16	7,9	97,0	125,0
13550	5 G 1,5	16	8,6	119,0	158,0
13552	7 G 1,5	16	10,2	147,0	210,0
13554	8 G 1,5	16	11,1	170,0	244,0
13556	10 G 1,5	16	12,0	193,0	315,0
13557	12 G 1,5	16	12,5	267,0	340,0

Part no.	No. cores x cross-sec. mm ²	AWG-No.	Outer Ø app. mm	Cop. weight kg / km	Weight app. kg / km
13558	16 G 1,5	16	13,8	315,0	424,0
13559	18 G 1,5	16	15,0	374,0	480,0
13560	20 G 1,5	16	15,7	396,0	545,0
13561	25 G 1,5	16	18,0	526,0	702,0
13562	2 x 2,5	14	8,3	96,0	132,0
13563	3 G 2,5	14	9,0	144,0	168,0
13565	4 G 2,5	14	9,8	148,0	195,0
13566	5 G 2,5	14	10,9	181,0	256,0
13567	7 G 2,5	14	12,9	255,0	345,0
13568	8 G 2,5	17	13,8	285,0	390,0
13569	10 G 2,5	14	15,8	340,0	482,0
13570	12 G 2,5	14	15,9	441,0	572,0
13571	2 x 4	12	9,8	120,0	220,0
13572	3 G 4	12	10,6	174,0	251,0
13573	4 G 4	12	11,5	230,0	305,0
13574	5 G 4	12	12,7	273,0	388,0
13575	7 G 4	12	13,9	316,0	504,0
13576	2 x 6	10	11,5	173,0	270,0
13577	3 G 6	10	12,4	240,0	351,0
13578	4 G 6	10	13,8	305,0	464,0
13579	5 G 6	10	15,7	439,0	546,0
13580	7 G 6	10	16,6	505,0	670,0
13581	2 x 10	8	14,9	255,0	461,0
13582	3 G 10	8	15,9	350,0	574,0
13583	4 G 10	8	17,8	535,0	785,0
13584	5 G 10	8	19,6	592,0	914,0
13585	7 G 10	8	21,6	810,0	1308,0
13586	2 x 16	6	17,3	422,0	670,0
13587	3 G 16	6	18,5	585,0	911,0
13588	4 G 16	6	20,8	740,0	1105,0
13589	5 G 16	6	22,9	895,0	1293,0
13590	7 G 16	6	25,0	1282,0	2149,0
13591	4 G 25	4	26,2	1140,0	1911,0
13592	4 G 35	2	30,4	1576,0	2542,0
13593	4 G 50	1	34,6	2155,0	3550,0
13594	4 G 70	2/0	41,3	3120,0	4939,0
13595	4 G 95	3/0	46,2	4043,0	6690,0
13596	4 G 120	4/0	51,0	5069,0	8453,0
13597	4 G 150	300 kcmil	59,0	5792,0	9104,0

Dimensions and specifications may be changed without prior notice. (RA03)

JZ-600

flexible, number coded, 0,6/1 kV, meter marking



Technical data

- Special PVC control cable adapted to DIN VDE 0262 and DIN VDE 0285-525-2-51 / DIN EN 50525-2-51, with insulation wall thickness for 1 kV
- **Temperature range**
flexing -15°C to +80°C
fixed installation -40°C to +80°C
- **Nominal voltage**
U₀/U 0,6/1 kV
- **Test voltage**
4000 V
- **Breakdown voltage**
min. 8000 V
- **Insulation resistance**
min. 20 MOhm x km
- **Minimum bending radius**
flexing 7,5x cable Ø
fixed installation 4x cable Ø
- **Radiation resistance**
up to 80x10⁶ cJ/kg (up to 80 Mrad)

Cable structure

- Bare copper conductor, to DIN VDE 0295 cl.5, fine wire, BS 6360 cl.5, IEC 60228 cl.5
- Core insulation of special PVC compound type T12 to DIN VDE 0207-363-3 / DIN EN 50363-3
- Core identification to DIN VDE 0293
black cores with continuous white numbering
- GN-YE conductor, 3 cores and above in the outer layer
- Cores stranded in layers with optimal lay length
- Outer sheath of special PVC compound type TM2 to DIN VDE 0207-363-4-1/DIN EN 50363-4-1
- Sheath colour: black (RAL 9005)
- With meter marking

Properties

- Extensively oil resistant, oil-/chemical resistance see "Technical Informations"
- The materials used during manufacturing are cadmium-free, contain no silicone and are free from substances harmful to the wetting properties of lacquers
- UV resistant

Tests

- PVC self-extinguishing and flame retardant acc. to DIN VDE 0482-332-1-2, DIN EN 60332-1-2, IEC 60332-1-2 (equivalent DIN VDE 0472 part 804 test method B)

Note

- G = with GN-YE conductor
x = without GN-YE conductor (OZ)
- AWG sizes are approximate equivalent values. The actual cross section is in mm².
- Screened analogue type:

JZ-600-Y-CY

Application

Wiring cable for measuring and controlling purposes in tool machinery, conveyor belts and production lines, for plant installations, air conditioning and in steel production plants and rolling mills. Suitable for installation for flexible use for medium mechanical stresses with free movement without tensile stress or forced movements in dry, moist and wet rooms as well as outside (fixed installation). Is not suitable to be used as direct burria (suitable from an outer diameter of 18,0 mm for direct burial) or as underwater cable. The cores have been numbered in such a way that the numbers are easily identifiable, even if the cable has only been stripped back a few cm. The core numbers have been underlined to avoid confusion. The earth core is located in the outer layer. The black, special PVC outer sheath is resistant to the ultra violet radiation. Mainly used in South-European, Eastern and Arabian countries.

= Product conforms with Low-Voltage Directive 2014/35/EU.

Part no.	No. cores x cross-sec. mm ²	Outer Ø app. mm	Cop. weight kg / km	Weight app. kg / km	AWG-No.
10550	2 x 0,5	6,2	9,6	56,0	20
10551	3 G 0,5	6,5	14,0	68,0	20
10552	3 x 0,5	6,5	14,0	68,0	20
10553	4 G 0,5	7,1	19,0	100,0	20
10554	4 x 0,5	7,1	19,0	100,0	20
10555	5 G 0,5	7,9	24,0	117,0	20
10556	5 x 0,5	7,9	24,0	117,0	20
10557	6 G 0,5	8,5	29,0	126,0	20
10558	7 G 0,5	8,5	34,0	138,0	20
10559	7 x 0,5	8,5	34,0	138,0	20
10560	8 G 0,5	9,5	38,0	150,0	20
10561	8 x 0,5	9,5	38,0	150,0	20
10562	10 G 0,5	10,8	48,0	176,0	20
10563	12 G 0,5	11,3	58,0	200,0	20
10564	12 x 0,5	11,3	58,0	200,0	20
10565	14 G 0,5	12,1	67,0	230,0	20
10566	16 G 0,5	12,7	76,0	250,0	20
10567	18 G 0,5	13,5	86,0	276,0	20
10568	20 G 0,5	14,2	96,0	293,0	20
10569	21 G 0,5	14,2	96,0	305,0	20
10570	25 G 0,5	15,8	120,0	335,0	20
10571	30 G 0,5	16,9	144,0	348,0	20
10572	32 G 0,5	18,5	154,0	355,0	20
10573	34 G 0,5	18,7	163,0	520,0	20
10574	40 G 0,5	20,1	192,0	590,0	20

Part no.	No. cores x cross-sec. mm ²	Outer Ø app. mm	Cop. weight kg / km	Weight app. kg / km	AWG-No.
10575	42 G 0,5	20,1	202,0	595,0	20
10576	50 G 0,5	21,7	240,0	715,0	20
10577	52 G 0,5	21,7	252,0	740,0	20
10578	61 G 0,5	23,1	293,0	840,0	20
10579	65 G 0,5	24,6	312,0	880,0	20
10580	80 G 0,5	26,7	384,0	960,0	20
10581	100 G 0,5	29,6	480,0	1050,0	20
10582	2 x 0,75	6,7	14,0	66,0	19
10583	3 G 0,75	7,1	22,0	74,0	19
10584	3 x 0,75	7,1	22,0	74,0	19
10585	4 G 0,75	7,7	29,0	126,0	19
10586	4 x 0,75	7,7	29,0	126,0	19
10587	5 G 0,75	8,5	36,0	140,0	19
10588	5 x 0,75	8,5	36,0	140,0	19
10589	6 G 0,75	9,5	43,0	170,0	19
10590	6 x 0,75	9,5	43,0	170,0	19
10591	7 G 0,75	9,5	50,0	190,0	19
10592	7 x 0,75	9,5	50,0	190,0	19
10593	8 G 0,75	10,5	58,0	212,0	19
10594	8 x 0,75	10,5	58,0	212,0	19
10595	9 G 0,75	11,8	65,0	227,0	19
10596	10 G 0,75	12,0	72,0	238,0	19
10597	12 G 0,75	12,6	86,0	257,0	19
10598	12 x 0,75	12,6	86,0	257,0	19
10599	14 G 0,75	13,2	101,0	286,0	19

Continuation ▶

JZ-600

flexible, number coded, 0,6/1 kV, meter marking



Part no.	No.cores x cross-sec. mm ²	Outer Ø app. mm	Cop. weight kg / km	Weight app. kg / km	AWG-No.
10600	15 G 0,75	14,0	108,0	319,0	19
10601	18 G 0,75	14,8	130,0	362,0	19
10602	20 G 0,75	15,7	144,0	394,0	19
10603	21 G 0,75	15,7	151,0	422,0	19
10604	25 G 0,75	17,5	180,0	486,0	19
10605	32 G 0,75	19,3	230,0	595,0	19
10606	34 G 0,75	20,3	245,0	638,0	19
10607	37 G 0,75	20,3	260,0	696,0	19
10608	40 G 0,75	21,8	288,0	726,0	19
10609	41 G 0,75	22,0	296,0	750,0	19
10610	42 G 0,75	22,0	302,0	770,0	19
10611	50 G 0,75	24,2	360,0	895,0	19
10612	61 G 0,75	25,8	439,0	1070,0	19
10613	65 G 0,75	27,4	468,0	1110,0	19
10614	80 G 0,75	29,5	576,0	1500,0	19
10615	100 G 0,75	32,7	720,0	1889,0	19
10616	2 x 1	7,0	19,2	80,0	18
10617	3 G 1	7,4	29,0	96,0	18
10618	3 x 1	7,4	29,0	96,0	18
10619	4 G 1	8,3	38,0	100,0	18
10620	4 x 1	8,3	38,0	100,0	18
10621	5 G 1	9,2	48,0	130,0	18
10622	5 x 1	9,2	48,0	130,0	18
10623	6 G 1	9,9	58,0	150,0	18
10624	7 G 1	9,9	67,0	170,0	18
10625	7 x 1	9,9	67,0	170,0	18
10626	8 G 1	11,0	77,0	230,0	18
10627	9 G 1	12,6	86,0	250,0	18
10628	10 G 1	12,8	96,0	270,0	18
10629	10 x 1	12,8	96,0	270,0	18
10630	12 G 1	13,2	115,0	290,0	18
10631	12 x 1	13,2	115,0	290,0	18
10632	14 G 1	14,1	134,0	320,0	18
10633	16 G 1	14,8	154,0	360,0	18
10634	18 G 1	15,7	173,0	405,0	18
10635	18 x 1	15,7	173,0	405,0	18
10636	20 G 1	16,7	192,0	450,0	18
10637	20 x 1	16,7	192,0	480,0	18
10638	21 G 1	16,7	205,0	510,0	18
10639	24 G 1	18,6	236,0	550,0	18
10640	25 G 1	18,6	240,0	570,0	18
10641	25 x 1	18,6	240,0	570,0	18
10642	26 G 1	19,0	252,0	590,0	18
10643	30 x 1	19,9	308,0	650,0	18
10644	34 G 1	21,5	326,0	750,0	18
10645	36 G 1	21,5	346,0	790,0	18
10646	40 G 1	23,4	384,0	850,0	18
10647	40 x 1	23,4	384,0	850,0	18
10648	41 G 1	23,4	394,0	890,0	18
10649	42 G 1	23,4	403,0	900,0	18
10650	50 G 1	25,7	480,0	1100,0	18
10651	56 G 1	26,4	538,0	1190,0	18
10652	61 G 1	27,3	586,0	1266,0	18
10653	65 G 1	29,0	628,0	1560,0	18
10654	80 G 1	31,4	786,0	1810,0	18
10655	100 G 1	34,8	960,0	1950,0	18
10656	2 x 1,5	8,2	29,0	95,0	16
10657	3 G 1,5	8,7	43,0	112,0	16
10658	3 x 1,5	8,7	43,0	112,0	16
10659	4 G 1,5	9,7	58,0	139,0	16
10660	4 x 1,5	9,7	58,0	139,0	16
10661	5 G 1,5	10,7	72,0	170,0	16
10662	5 x 1,5	10,7	72,0	170,0	16
10663	6 G 1,5	11,6	86,0	190,0	16
10664	7 G 1,5	11,6	101,0	225,0	16
10665	7 x 1,5	11,6	101,0	225,0	16
10666	8 G 1,5	13,1	115,0	250,0	16
10667	9 G 1,5	14,8	130,0	280,0	16
10668	10 G 1,5	15,0	144,0	300,0	16
10669	11 G 1,5	15,7	158,0	330,0	16
10670	12 G 1,5	15,7	173,0	370,0	16
10671	12 x 1,5	15,7	173,0	370,0	16
10672	14 G 1,5	16,7	202,0	400,0	16
10673	16 G 1,5	17,5	230,0	450,0	16
10674	18 G 1,5	18,6	259,0	520,0	16
10675	19 G 1,5	18,8	279,0	550,0	16
10676	20 G 1,5	19,8	288,0	600,0	16
10677	21 G 1,5	19,8	302,0	600,0	16
10678	25 G 1,5	22,2	360,0	730,0	16
10679	32 G 1,5	24,5	461,0	880,0	16
10680	34 G 1,5	25,6	490,0	950,0	16
10681	40 G 1,5	27,8	576,0	990,0	16

Part no.	No.cores x cross-sec. mm ²	Outer Ø app. mm	Cop. weight kg / km	Weight app. kg / km	AWG-No.
10682	42 G 1,5	27,8	605,0	1120,0	16
10683	50 G 1,5	30,5	720,0	1400,0	16
10684	56 G 1,5	31,5	806,0	1530,0	16
10685	61 G 1,5	32,6	878,0	1700,0	16
10686	65 G 1,5	34,6	936,0	1900,0	16
10687	80 G 1,5	37,4	1152,0	2300,0	16
10688	100 G 1,5	41,6	1440,0	2700,0	16
10689	2 x 2,5	9,6	48,0	160,0	14
10690	3 G 2,5	10,2	72,0	175,0	14
10691	3 x 2,5	10,2	72,0	175,0	14
10692	4 G 2,5	11,3	96,0	203,0	14
10693	4 x 2,5	11,3	96,0	203,0	14
10694	5 G 2,5	12,5	120,0	251,0	14
10695	5 x 2,5	12,5	120,0	251,0	14
10696	7 G 2,5	13,8	168,0	330,0	14
10697	7 x 2,5	13,8	168,0	330,0	14
10698	8 G 2,5	15,3	192,0	400,0	14
10699	12 G 2,5	18,6	288,0	553,0	14
10700	14 G 2,5	19,7	336,0	630,0	14
10701	18 G 2,5	22,0	432,0	795,0	14
10702	21 G 2,5	23,4	504,0	930,0	14
10703	25 G 2,5	26,2	600,0	1110,0	14
10704	34 G 2,5	30,4	816,0	1450,0	14
10705	42 G 2,5	33,2	1008,0	1750,0	14
10706	50 G 2,5	36,3	1200,0	2100,0	14
10707	61 G 2,5	38,8	1464,0	2540,0	14
10708	100 G 2,5	49,6	2400,0	3850,0	14
10709	2 x 4	11,0	77,0	180,0	12
10710	3 G 4	11,7	115,0	230,0	12
10711	4 G 4	13,0	154,0	310,0	12
10712	5 G 4	14,3	192,0	410,0	12
10713	7 G 4	15,8	269,0	540,0	12
10714	8 G 4	17,5	307,0	710,0	12
10715	12 G 4	21,5	461,0	860,0	12
10716	3 G 6	13,2	173,0	370,0	10
10717	4 G 6	14,6	230,0	430,0	10
10718	5 G 6	16,2	288,0	650,0	10
10719	7 G 6	18,6	403,0	860,0	10
10720	3 G 10	16,8	288,0	660,0	8
10721	4 G 10	18,6	384,0	790,0	8
10722	5 G 10	20,5	480,0	960,0	8
10723	7 G 10	22,8	672,0	1300,0	8
10724	3 G 16	20,2	461,0	700,0	6
10725	4 G 16	22,4	614,0	1100,0	6
10726	5 G 16	25,0	768,0	1600,0	6
10727	7 G 16	27,4	1075,0	1890,0	6
10728	3 G 25	24,8	720,0	1450,0	4
10729	4 G 25	27,4	960,0	1600,0	4
10730	5 G 25	30,5	1200,0	2050,0	4
10731	7 G 25	33,8	1680,0	2900,0	4
10732	3 G 35	27,4	1008,0	1900,0	2
10733	4 G 35	30,4	1344,0	2400,0	2
10734	5 G 35	33,6	1680,0	2900,0	2
10735	3 G 50	32,3	1440,0	2700,0	1
10736	4 G 50	35,8	1920,0	3400,0	1
10742	5 G 50	39,7	2400,0	4361,0	1
10737	3 G 70	36,6	2016,0	3300,0	2/0
10738	4 G 70	40,7	2688,0	4400,0	2/0
10743	5 G 70	44,9	3360,0	5807,0	2/0
10739	3 G 95	41,9	2736,0	5050,0	3/0
10740	4 G 95	46,6	3648,0	6010,0	3/0
10744	5 G 95	51,7	4560,0	7752,0	3/0
10741	4 G 120	51,6	4608,0	7500,0	4/0
10745	4 G 150	57,4	5760,0	8640,0	300 kcmil
10746	4 G 185	63,2	7104,0	10380,0	350 kcmil

Dimensions and specifications may be changed without prior notice. (RA01)

JZ-600-Y-CY

flexible, number coded, 0,6/1 kV, Cu screened meter marking, EMC-preferred type



Technical data

- Adapted to DIN VDE 0262 and DIN VDE 0285-525-2-51 / DIN EN 50525-2-51
- **Temperature range**
flexing -15°C to +80°C
fixed installation -40°C to +80°C
- **Nominal voltage**
U₀/U 0,6/1 kV
- **Test voltage**
4000 V
- **Breakdown voltage**
min. 8000 V
- **Insulation resistance**
min. 20 MOhm x km
- **Coupling resistance**
max. 250 Ohm/km
- **Minimum bending radius**
flexing 10x cable Ø
fixed installation 5x cable Ø
- **Radiation resistance**
up to 80x10⁶ cJ/kg (up to 80 Mrad)

Cable structure

- Bare copper conductor, to DIN VDE 0295 cl.5, fine wire, BS 6360 cl.5, IEC 60228 cl.5
- Core insulation of Special PVC compound type T12 to DIN VDE 0207-363-3 / DIN EN 50363-3
- Core identification to DIN VDE 0293 black cores with continuous white numbering
- GN-YE conductor, 3 cores and above in the outer layer
- Cores stranded in layers with optimal lay length
- Inner sheath of PVC
- Tinned copper braided screen, approx. 85% coverage
- Outer sheath of special PVC compound type TM2 to DIN VDE 0207-363-4-1/DIN EN 50363-4-1
- Sheath colour: black (RAL 9005)
- With meter marking

Properties

- Extensively oil resistant, oil-/chemical resistance see "Technical Informations"
- The materials used during manufacturing are cadmium-free, contain no silicone and are free from substances harmful to the wetting properties of lacquers
- UV resistant

Tests

- PVC self-extinguishing and flame retardant acc. to DIN VDE 0482-332-1-2, DIN EN 60332-1-2, IEC 60332-1-2 (equivalent DIN VDE 0472 part 804 test method B)

Note

- G = with GN-YE conductor
x = without GN-YE conductor (OZ)
- Further sizes are available on request.
- AWG sizes are approximate equivalent values. The actual cross section is in mm².
- Unscreened analogue type:

JZ-600

Application

Wiring cable for measuring and controlling purposes in tool machinery, conveyor belts and production lines, for plant installations, air conditioning and in steel production plants and rolling mills. Suitable for installation for flexible use for medium mechanical stresses with free movement without tensile stress or forced movements in dry, moist and wet rooms as well as outside (fixed installation). Is not suitable to be used as direct burial (suitable from an outer diameter of 20 mm for direct burial) or as underwater cable. The cores have been numbered in such a way that the numbers are easily identifiable, even if the cable has only been stripped back a few cm. The core numbers have been underlined to avoid confusion. The earth core is located in the outer layer. The black, special PVC outer sheath is resistant to the ultra violet radiation. Mainly used in South-European, Eastern and Arabian countries. Interference-free transmission of signals and pulses is assured by the high degree of screening.

EMC = Electromagnetic compatibility

To optimize the EMC features we recommend a large round contact of the copper braiding on both ends.

= Product conforms with Low-Voltage Directive 2014/35/EU.

Part no.	No. cores x cross-sec. mm ²	Outer Ø app. mm	Cop. weight kg / km	Weight app. kg / km	AWG-No.
11464	2 x 0,5	8,5	41,0	115,0	20
11465	3 G 0,5	8,8	45,0	127,0	20
11466	4 G 0,5	9,4	54,0	149,0	20
11467	5 G 0,5	10,2	66,0	169,0	20
11469	7 G 0,5	10,8	79,0	230,0	20
11472	12 G 0,5	14,3	137,0	386,0	20
11475	18 G 0,5	16,4	156,0	428,0	20
11478	25 G 0,5	19,3	250,0	693,0	20
11489	2 x 0,75	8,8	46,0	128,0	19
11490	3 G 0,75	9,1	57,0	143,0	19
11491	4 G 0,75	9,9	63,0	164,0	19
11492	5 G 0,75	10,6	76,0	198,0	19
11494	7 G 0,75	11,5	100,0	232,0	19
11498	12 G 0,75	15,0	175,0	360,0	19
11501	18 G 0,75	17,2	240,0	562,0	19
11504	25 G 0,75	20,6	306,0	729,0	19

Part no.	No. cores x cross-sec. mm ²	Outer Ø app. mm	Cop. weight kg / km	Weight app. kg / km	AWG-No.
11516	2 x 1	9,2	54,0	146,0	18
11517	3 G 1	9,8	64,0	165,0	18
11518	4 G 1	10,4	76,0	204,0	18
11519	5 G 1	11,4	89,0	224,0	18
11521	7 G 1	12,3	114,0	379,0	18
11525	12 G 1	15,9	186,0	430,0	18
11528	18 G 1	18,2	284,0	636,0	18
11532	25 G 1	22,0	387,0	837,0	18
11546	2 x 1,5	10,4	64,0	175,0	16
11547	3 G 1,5	10,8	82,0	213,0	16
11548	4 G 1,5	11,5	99,0	247,0	16
11549	5 G 1,5	13,0	123,0	300,0	16
11551	7 G 1,5	14,2	148,0	364,0	16
11556	12 G 1,5	18,4	274,0	668,0	16
11559	18 G 1,5	21,3	386,0	844,0	16
11563	25 G 1,5	25,4	531,0	1356,0	16

Continuation ▶

JZ-600-Y-CY

flexible, number coded, 0,6/1 kV, Cu screened meter marking, EMC-preferred type



Part no.	No. cores x cross-sec. mm ²	Outer Ø app. mm	Cop. weight kg / km	Weight app. kg / km	AWG-No.	Part no.	No. cores x cross-sec. mm ²	Outer Ø app. mm	Cop. weight kg / km	Weight app. kg / km	AWG-No.
11574	2 x 2,5	11,8	110,0	241,0	14	11608	3 G 16	23,4	653,0	1395,0	6
11575	3 G 2,5	12,8	148,0	266,0	14	11609	4 G 16	25,7	807,0	1426,0	6
11576	4 G 2,5	13,8	169,0	351,0	14	11610	5 G 16	28,5	940,0	2720,0	6
11577	5 G 2,5	15,0	220,0	434,0	14	11611	7 G 16	31,4	1345,0	3213,0	6
11578	7 G 2,5	16,3	284,0	517,0	14	11612	3 G 25	28,2	920,0	1810,0	4
11580	12 G 2,5	21,6	470,0	862,0	14	11613	4 G 25	31,3	1169,0	2261,0	4
11582	18 G 2,5	25,2	572,0	1236,0	14	11614	5 G 25	34,5	1420,0	2773,0	4
11584	25 G 2,5	30,0	740,0	1659,0	14	11615	7 G 25	37,8	1921,0	4980,0	4
11590	2 x 4	13,6	124,0	306,0	12	11616	3 G 35	31,2	1250,0	2400,0	2
11591	3 G 4	14,6	178,0	444,0	12	11617	4 G 35	34,5	1680,0	2973,0	2
11592	4 G 4	15,7	234,0	489,0	12	11618	5 G 35	38,0	2020,0	3548,0	2
11593	5 G 4	17,2	284,0	623,0	12	11619	3 G 50	36,5	1887,0	3120,0	1
11594	7 G 4	18,9	321,0	775,0	12	11620	4 G 50	40,5	2370,0	3873,0	1
11596	12 G 4	24,5	581,0	1244,0	12	11621	5 G 50	45,2	2880,0	4634,0	1
11597	2 x 6	14,9	176,0	433,0	10	11622	3 G 70	41,8	2516,0	4220,0	2/0
11598	3 G 6	15,9	245,0	572,0	10	11623	4 G 70	46,0	3257,0	5546,0	2/0
11599	4 G 6	17,4	316,0	673,0	10	11624	5 G 70	50,4	4032,0	6410,0	2/0
11600	5 G 6	19,2	442,0	841,0	10	11625	3 G 95	46,8	3086,0	5240,0	3/0
11601	7 G 6	20,9	530,0	1078,0	10	11626	4 G 95	51,3	4060,0	6538,0	3/0
11602	2 x 10	18,6	260,0	640,0	8	11627	5 G 95	56,1	5244,0	7812,0	3/0
11603	3 G 10	19,8	367,0	820,0	8	11628	3 G 120	51,8	4176,0	7210,0	4/0
11604	4 G 10	21,5	549,0	979,0	8	11629	4 G 120	56,3	5231,0	7994,0	4/0
11605	5 G 10	23,5	604,0	1207,0	8	13137	4 G 150	64,4	7760,0	10305,0	300 kcmil
11606	7 G 10	25,6	820,0	2210,0	8	13147	4 G 185	69,5	8104,0	12154,0	350 kcmil
11607	2 x 16	21,8	491,0	1150,0	6						

Dimensions and specifications may be changed without prior notice. (RA01)

JZ-600 HMH

flexible control cable, halogen-free, extremely fire resistant, oil resistant¹⁾, 0,6/1 kV, meter marking



Technical data

- Halogen-free, flexible control cable, adapted to DIN VDE 0285-525-2-51 / DIN EN 50525-2-51 and DIN VDE 0285-525-3-11 / DIN EN 50525-3-11
- **Temperature range**
flexing -15°C to +70°C
fixed -40°C to +70°C
- **Nominal voltage**
U₀/U 0,6/1 kV
- **Test voltage**
4000 V
- **Minimum bending radius**
flexing 15x cable Ø
fixed installation 7,5x cable Ø
- **Radiation resistance**
up to 100x10⁶ cJ/kg (up to 100 Mrad)

Cable structure

- Bare copper conductor, to DIN VDE 0295 cl.5, fine wire, BS 6360 cl.5, IEC 60228 cl.5
- Core insulation of halogen-free polymer compound type T16 to DIN VDE 0207-363-7 / DIN EN 50363-7
- Core identification to DIN VDE 0293 black cores with continuous white numbering
- GN-YE conductor, 3 cores and above in the outer layer
- Cores stranded in layers with optimal lay length
- Outer sheath of halogen-free polymer compound type TM7 to DIN VDE 0207-363-8 / DIN EN 50363-8
- Sheath colour: black (RAL 9005)
- With meter marking
- **LSOH**= Low Smoke Zero Halogen

Properties

- ¹⁾ For critical applications, we recommend that you consult
- The materials used during manufacturing are cadmium-free, contain no silicone and are free from substances harmful to the wetting properties of lacquers

Tests

- Flame test acc. to DIN VDE 0482-332-3-24, BS 4066 part 3, DIN EN 60332-3-24, IEC 60332-3-24 (previously DIN VDE 0472 part 804 test method C)
- Self-extinguishing and flame retardant acc. to DIN VDE 0482-332-1-2, DIN EN 60332-1-2, IEC 60332-1-2 (equivalent DIN VDE 0472 part 804 test method B)
- Corrosiveness of combustion gases acc. to DIN VDE 0482-754-2, DIN EN 60754-2, IEC 60754-2 (previously DIN VDE 0482-267-2-2)
- Halogen-free acc. to DIN VDE 0482-754-1, DIN EN 60754-1, IEC 60754-1 (previously DIN VDE 0482-267-2-1)
- Smoke density acc. to DIN VDE 0482 part 1034-1+2, DIN EN 61034-1+2, IEC 61034-1+2, BS 7622 part 1+2

Note

- G = with GN-YE conductor
x = without GN-YE conductor (OZ)
- AWG sizes are approximate equivalent values. The actual cross section is in mm².
- Screened analogue type:

JZ-600 HMH-C

Application

Halogen-free, flame retardant cables are used as measuring and control cable in machine tools, conveyor belts, production lines as well as in plant installations, in heating and air-conditioning systems and steel production works. For fixed installation or flexible application, directed without forcing by casual, constantly recurring free movements and without tensile stress, for medium mechanical strain. This cable is suitable for the application in dry, damp and wet environments, outdoors (fixed installation) and for laying on plaster.

EMC = Electromagnetic compatibility

To optimize the EMC features we recommend a large round contact of the copper braiding on both ends.

CE = Product conforms with Low-Voltage Directive 2014/35/EU.

Part no.	No. cores x cross-sec. mm ²	Outer Ø app. mm	Cop. weight kg / km	Weight app. kg / km	AWG-No.
12723	2 x 0,5	6,3	9,6	57,0	20
12724	3 G 0,5	6,6	14,4	69,0	20
12725	3 x 0,5	6,6	14,4	69,0	20
12726	4 G 0,5	7,2	19,0	104,0	20
12727	4 x 0,5	7,2	19,0	104,0	20
12728	5 G 0,5	8,0	24,0	121,0	20
12729	5 x 0,5	8,0	24,0	121,0	20
12730	7 G 0,5	8,7	33,6	145,0	20
12731	10 G 0,5	10,3	48,0	186,0	20
12732	12 G 0,5	11,2	58,0	224,0	20
12733	18 G 0,5	13,8	86,0	292,0	20
12734	25 G 0,5	16,1	120,0	357,0	20

Part no.	No. cores x cross-sec. mm ²	Outer Ø app. mm	Cop. weight kg / km	Weight app. kg / km	AWG-No.
12735	2 x 0,75	6,6	14,4	68,0	19
12736	3 G 0,75	6,9	21,6	77,0	19
12737	3 x 0,75	6,9	21,6	77,0	19
12738	4 G 0,75	7,5	29,0	136,0	19
12739	4 x 0,75	7,5	29,0	136,0	19
12740	5 G 0,75	8,4	36,0	152,0	19
12741	5 x 0,75	8,4	36,0	152,0	19
12742	7 G 0,75	9,3	50,0	208,0	19
12743	10 G 0,75	11,4	72,0	250,0	19
12744	12 G 0,75	12,2	86,0	271,0	19
12745	18 G 0,75	14,5	130,0	387,0	19
12746	25 G 0,75	17,2	180,0	498,0	19

Continuation ▶

JZ-600 HMH

flexible control cable, halogen-free, extremely fire resistant,
oil resistant¹⁾, 0,6/1 kV, meter marking



Part no.	No. cores x cross-sec. mm ²	Outer Ø app. mm	Cop. weight kg / km	Weight app. kg / km	AWG-No.
12747	2 x 1	7,0	19,2	82,0	18
12748	3 G 1	7,4	29,0	99,0	18
12749	3 x 1	7,4	29,0	99,0	18
12750	4 G 1	8,2	38,4	140,0	18
12751	4 x 1	8,2	38,4	140,0	18
12752	5 G 1	9,2	48,0	160,0	18
12753	5 x 1	9,2	48,0	160,0	18
12754	7 G 1	9,9	67,0	217,0	18
12755	10 G 1	11,9	96,0	271,0	18
12756	12 G 1	12,8	115,0	301,0	18
12757	18 G 1	15,7	173,0	417,0	18
12758	25 G 1	18,6	240,0	576,0	18
12759	2 x 1,5	8,2	29,0	97,0	16
12760	3 G 1,5	8,6	43,0	119,0	16
12761	3 x 1,5	8,6	43,0	119,0	16
12762	4 G 1,5	9,6	58,0	148,0	16
12763	4 x 1,5	9,6	58,0	148,0	16
12764	5 G 1,5	10,7	72,0	172,0	16
12765	5 x 1,5	10,7	72,0	172,0	16
12766	7 G 1,5	11,6	101,0	243,0	16
12767	10 G 1,5	15,2	144,0	311,0	16
12768	12 G 1,5	15,5	173,0	392,0	16
12769	18 G 1,5	18,6	259,0	529,0	16
12770	25 G 1,5	22,5	360,0	741,0	16
12771	2 x 2,5	9,6	48,0	160,0	14
12772	3 G 2,5	10,1	72,0	177,0	14
12773	3 x 2,5	10,1	72,0	177,0	14
12774	4 G 2,5	11,2	96,0	209,0	14
12775	4 x 2,5	11,2	96,0	209,0	14

Part no.	No. cores x cross-sec. mm ²	Outer Ø app. mm	Cop. weight kg / km	Weight app. kg / km	AWG-No.
12776	5 G 2,5	12,5	120,0	272,0	14
12777	5 x 2,5	12,5	120,0	272,0	14
12778	7 G 2,5	13,8	168,0	340,0	14
12779	10 G 2,5	16,6	288,0	561,0	14
12780	12 G 2,5	18,3	432,0	799,0	14
12781	18 G 2,5	22,0	480,0	940,0	14
12782	25 G 2,5	26,2	600,0	1121,0	14
12783	3 G 4	11,7	115,0	255,0	12
12784	4 G 4	12,9	154,0	319,0	12
12785	5 G 4	14,4	192,0	423,0	12
12786	3 G 6	13,1	173,0	380,0	10
12787	4 G 6	14,5	230,0	441,0	10
12788	5 G 6	16,2	288,0	657,0	10
12789	3 G 10	16,8	288,0	668,0	8
12790	4 G 10	18,5	384,0	796,0	8
12791	5 G 10	20,5	480,0	972,0	8
12792	3 G 16	20,2	461,0	832,0	6
12793	4 G 16	22,4	614,0	1122,0	6
12794	5 G 16	25,0	768,0	1604,0	6
12795	3 G 25	24,8	720,0	1457,0	4
12796	4 G 25	27,4	960,0	1611,0	4
12797	5 G 25	30,5	1200,0	2070,0	4
12798	3 G 35	27,4	1008,0	1914,0	2
12799	4 G 35	30,3	1344,0	2424,0	2
12800	5 G 35	33,6	1680,0	2970,0	2
12801	4 G 50	35,8	1920,0	3467,0	1
12802	4 G 70	40,8	2688,0	4491,0	2/0
12803	4 G 95	46,2	3648,0	6170,0	3/0
12804	4 G 120	51,6	4608,0	7618,0	4/0

Dimensions and specifications may be changed without prior notice. (RA03)

JZ-600 HMH-C

flexible control cable, halogen-free, extremely fire resistant, oil resistant¹⁾, 0,6/1 kV, screened, EMC-preferred type, meter marking



Technical data

- Halogen-free, flexible control cable, core construction adapted to DIN VDE 0285-525-2-51 / DIN EN 50525-2-51 and DIN VDE 0285-525-3-11 / DIN EN 50525-3-11
- **Temperature range**
flexing -15°C to +70°C
fixed -40°C to +70°C
- **Nominal voltage**
U₀/U 0,6/1 kV
- **Test voltage**
4000 V
- **Coupling resistance**
max. 250 Ohm/km
- **Minimum bending radius**
flexing 15x cable Ø
fixed installation 7,5x cable Ø
- **Radiation resistance**
up to 100x10⁶ cJ/kg (up to 100 Mrad)

Cable structure

- Bare copper conductor, to DIN VDE 0295 cl.5, fine wire, BS 6360 cl.5, IEC 60228 cl.5
- Core insulation of halogen-free polymer compound type T16 to DIN VDE 0207-363-7 / DIN EN 50363-7
- Core identification to DIN VDE 0293 black cores with continuous white numbering
- GN-YE conductor, 3 cores and above in the outer layer
- Cores stranded in layers with optimal lay length
- Inner sheath
- Tinned copper braided screen, approx. 85% coverage
- Outer sheath of halogen-free polymer compound type, TM7 to DIN VDE 0207-363-8 / DIN EN 50363-8
- Sheath colour: black (RAL 9005)
- With meter marking
- **LSOH**= Low Smoke Zero Halogen

Properties

- ¹⁾ For critical applications recommend you request a consultation
- The materials used during manufacturing are cadmium-free, contain no silicone and are free from substances harmful to the wetting properties of lacquers

Tests

- Flame test acc. to DIN VDE 0482-332-3-24, BS 4066 part 3, DIN EN 60332-3-24, IEC 60332-3-24 (previously DIN VDE 0472 part 804 test method C)
- Self-extinguishing and flame retardant acc. to DIN VDE 0482-332-1-2, DIN EN 60332-1-2, IEC 60332-1-2 (equivalent DIN VDE 0472 part 804 test method B)
- Corrosiveness of combustion gases acc. to DIN VDE 0482-754-2, DIN EN 60754-2, IEC 60754-2 (previously DIN VDE 0482-267-2-2)
- Halogen-free acc. to DIN VDE 0482-754-1, DIN EN 60754-1, IEC 60754-1 (previously DIN VDE 0482-267-2-1)
- Smoke density acc. to DIN VDE 0482 part 1034-1+2, DIN EN 61034-1+2, IEC 61034-1+2, BS 7622 part 1+2

Note

- G = with GN-YE conductor
- AWG sizes are approximate equivalent values. The actual cross section is in mm².
- Unscreened analogue type:

JZ-600 HMH

Application

Halogen-free, flame retardant cables are used as measuring and control cable in machine tools, conveyor belts, production lines as well as in plant installations, in heating and air-conditioning systems and steel production works. For fixed installation or flexible application, directed without forcing by casual, constantly recurring free movements and without tensile stress, for medium mechanical strain. This cable is suitable for the application in dry, damp and wet environments, outdoors (fixed installation) and for laying on plaster. The dense screening assures interference-free transmission of all signals and impulses.

EMC = Electromagnetic compatibility

To optimize the EMC features we recommend a large round contact of the copper braiding on both ends.

CE = Product conforms with Low-Voltage Directive 2014/35/EU.

Part no.	No. cores x cross-sec. mm ²	Outer Ø app. mm	Cop. weight kg / km	Weight app. kg / km	AWG-No.
12850	3 G 0,5	8,8	45,0	150,0	20
12851	4 G 0,5	9,4	54,0	170,0	20
12852	5 G 0,5	10,2	66,0	199,0	20
12853	7 G 0,5	10,8	79,0	235,0	20
12854	12 G 0,5	14,3	137,0	320,0	20
12855	18 G 0,5	16,4	156,0	428,0	20
12856	25 G 0,5	19,3	250,0	503,0	20
12857	3 G 0,75	9,1	57,0	155,0	19
12858	4 G 0,75	9,9	63,0	190,0	19
12859	5 G 0,75	10,6	76,0	228,0	19
12860	7 G 0,75	11,5	100,0	323,0	19
12861	12 G 0,75	14,9	175,0	410,0	19
12862	18 G 0,75	17,2	240,0	560,0	19
12863	25 G 0,75	20,6	306,0	730,0	19

Part no.	No. cores x cross-sec. mm ²	Outer Ø app. mm	Cop. weight kg / km	Weight app. kg / km	AWG-No.
12864	3 G 1	9,8	64,0	163,0	18
12865	4 G 1	10,4	76,0	200,0	18
12866	5 G 1	11,4	89,0	239,0	18
12867	7 G 1	12,3	114,0	289,0	18
12868	12 G 1	15,9	186,0	464,0	18
12869	18 G 1	18,2	284,0	628,0	18
12870	25 G 1	22,0	387,0	855,0	18
12871	3 G 1,5	10,8	82,0	187,0	16
12872	4 G 1,5	11,5	99,0	240,0	16
12873	5 G 1,5	13,0	123,0	289,0	16
12874	7 G 1,5	14,2	148,0	383,0	16
12875	12 G 1,5	18,4	274,0	592,0	16
12876	18 G 1,5	21,3	386,0	806,0	16
12877	25 G 1,5	25,4	531,0	1241,0	16

Continuation ▶

JZ-600 HMH-C

flexible control cable, halogen-free, extremely fire resistant,
oil resistant¹⁾, 0,6/1 kV, screened, EMC-preferred type, meter marking



Part no.	No. cores x cross-sec. mm ²	Outer Ø app. mm	Cop. weight kg / km	Weight app. kg / km	AWG-No.	Part no.	No. cores x cross-sec. mm ²	Outer Ø app. mm	Cop. weight kg / km	Weight app. kg / km	AWG-No.
12878	3 G 2,5	12,8	148,0	298,0	14	12894	4 G 16	25,7	807,0	1395,0	6
12879	4 G 2,5	13,8	169,0	345,0	14	12895	5 G 16	28,5	940,0	1870,0	6
12880	5 G 2,5	15,0	220,0	427,0	14	12896	7 G 16	31,4	1345,0	2720,0	6
12881	7 G 2,5	16,3	284,0	561,0	14	12897	3 G 25	28,2	920,0	2465,0	4
12882	12 G 2,5	21,6	470,0	857,0	14	12898	4 G 25	31,3	1169,0	2750,0	4
12883	18 G 2,5	25,2	572,0	1355,0	14	12899	5 G 25	34,5	1420,0	3490,0	4
12884	25 G 2,5	30,0	740,0	1995,0	14	12900	3 G 35	31,2	1250,0	3230,0	2
12885	3 G 4	14,6	178,0	391,0	12	12901	4 G 35	34,5	1680,0	4100,0	2
12886	4 G 4	15,7	234,0	527,0	12	12902	5 G 35	38,0	2020,0	4950,0	2
12887	5 G 4	17,2	284,0	700,0	12	12903	4 G 50	40,5	2370,0	5780,0	1
12888	3 G 6	15,9	245,0	629,0	10	12904	4 G 70	46,0	3257,0	7480,0	2/0
12889	4 G 6	17,4	316,0	731,0	10	12905	4 G 95	51,3	4060,0	10220,0	3/0
12890	5 G 6	19,2	442,0	1105,0	10	12906	4 G 120	56,4	5231,0	13750,0	4/0
12891	3 G 10	19,8	367,0	1125,0	8	12907	4 G 150	64,4	6794,0	15900,0	4/0
12892	4 G 10	21,5	549,0	1345,0	8						
12893	5 G 10	23,5	604,0	1635,0	8						

Dimensions and specifications may be changed without prior notice. (RA03)

JZ-600 UL/CSA

flexible, number coded, 1000 V, meter marking



Technical data

- Special PVC control cables adapted to DIN VDE 0276 part 627, DIN VDE 0285-525-2-51 / DIN EN 50525-2-51, with insulation thickness for 1 kV and to UL Std.758 Style 21179
- **Temperature range**
flexing -5°C to +80°C
fixed installation -40°C to +80°C
- **Nominal voltage**
VDE U₀/U 600/1000 V
UL/CSA 1000 V
- **Test voltage**
4000 V
- **Breakdown voltage**
min. 8000 V
- **Insulation resistance**
min. 20 MOhm x km
- **Minimum bending radius**
flexing 7,5x cable Ø
fixed installation 4x cable Ø
- **Radiation resistance**
up to 80x10⁶ cJ/kg (up to 80 Mrad)

Cable structure

- Bare copper conductor, to DIN VDE 0295 cl.5, fine wire, BS 6360 cl.5, IEC 60228 cl.5
- Core insulation of special PVC compound type T12 to DIN VDE 0207-363-3 / DIN EN 50363-3 and class 43 acc. to UL Std.1581
- Core identification to DIN VDE 0293 black cores with continuous white numbering
- GN-YE conductor, 3 cores and above in the outer layer
- Cores stranded in layers with optimal lay length
- Outer sheath of special PVC compound type TM2 to DIN VDE 0207-363-4-1/DIN EN 50363-4-1 and class 43 acc. to UL Std.1581
- Sheath colour: black (RAL 9005) or grey (RAL 7001)
- With meter marking

Properties

- Extensively oil resistant, oil-/chemical resistance see "Technical Informations"
- UV resistant (building with black sheath)
- The materials used during manufacturing are cadmium-free, contain no silicone and are free from substances harmful to the wetting properties of lacquers

Tests

- PVC self-extinguishing and flame retardant acc. to DIN VDE 0482-332-1-2, DIN EN 60332-1-2, IEC 60332-1-2 (equivalent DIN VDE 0472 part 804 test method B), UL VW-1, CSA FT1

Note

- G = with GN-YE conductor
x = without GN-YE conductor (OZ)
- AWG sizes are approximate equivalent values. The actual cross section is in mm².
- Screened analogue type:
JZ-600-Y-CY UL/CSA

Application

Wiring cable for measuring and controlling purposes in tool machinery, conveyor belts and production lines, for plant installations, air conditioning and in steel production plants and rolling mills. Suitable for installation for flexible use for medium mechanical stresses with free movement without tensile stress or forced movements in dry, moist and wet rooms as well as outside (fixed installation, building with black sheath). Is not suitable to be used as direct burial- or as underwater cable. The cores have been numbered in such a way that the numbers are easily identifiable, even if the cable has only been stripped back a few cm. The core numbers have been underlined to avoid confusion. The earth core is located in the outer layer. The black, special PVC outer sheath is resistant to the ultra violet radiation. Mainly used in South-European, Eastern and Arabian countries.

☑ = Product conforms with Low-Voltage Directive 2014/35/EU.

Part no.	No. cores x cross-sec.	AWG-No.	Outer Ø app. mm	Cop. weight kg / km	Weight app. kg / km
black					
11815	2 x 0,5	20	6,4	9,6	56,0
11816	3 G 0,5	20	6,8	14,4	68,0
11817	4 G 0,5	20	7,6	19,0	100,0
11818	5 G 0,5	20	8,2	24,0	117,0
11819	7 G 0,5	20	9,8	33,6	138,0
11820	12 G 0,5	20	12,2	58,0	200,0
11821	18 G 0,5	20	14,4	86,0	276,0
11822	25 G 0,5	20	17,2	120,0	335,0
11823	2 x 0,75	19	6,8	14,4	66,0
11824	3 G 0,75	19	7,2	21,6	74,0
11825	4 G 0,75	19	8,0	29,0	126,0
11826	5 G 0,75	19	8,8	36,0	140,0
11827	7 G 0,75	19	10,7	50,0	190,0
11828	12 G 0,75	19	13,1	86,0	257,0
11829	18 G 0,75	19	15,6	130,0	362,0
11830	25 G 0,75	19	18,9	180,0	486,0
11831	2 x 1	18	7,4	19,2	80,0
11832	3 G 1	18	8,0	29,2	96,0
11833	4 G 1	18	8,8	38,4	100,0
11834	5 G 1	18	9,8	48,0	130,0
11835	7 G 1	18	11,7	67,0	170,0
11836	12 G 1	18	14,5	115,0	290,0
11837	18 G 1	18	17,3	173,0	405,0
11838	25 G 1	18	21,1	240,0	570,0
11839	2 x 1,5	16	8,4	29,0	95,0
11840	3 G 1,5	16	9,1	43,0	112,0
11841	4 G 1,5	16	9,9	58,0	139,0
11842	5 G 1,5	16	11,0	72,0	170,0
11843	7 G 1,5	16	13,3	101,0	225,0
11844	12 G 1,5	16	16,6	173,0	370,0
11845	18 G 1,5	16	19,7	259,0	520,0
11846	25 G 1,5	16	23,9	360,0	730,0

Part no.	No. cores x cross-sec.	AWG-No.	Outer Ø app. mm	Cop. weight kg / km	Weight app. kg / km
grey					
11880	2 x 0,5	20	6,4	9,6	56,0
11881	3 G 0,5	20	6,8	14,4	68,0
11882	4 G 0,5	20	7,6	19,0	100,0
11883	5 G 0,5	20	8,2	24,0	117,0
11884	7 G 0,5	20	9,8	33,6	138,0
11885	12 G 0,5	20	12,2	58,0	200,0
11886	18 G 0,5	20	14,4	86,0	276,0
11887	25 G 0,5	20	17,2	120,0	335,0
11888	2 x 0,75	19	6,8	14,4	66,0
11889	3 G 0,75	19	7,2	21,6	74,0
11890	4 G 0,75	19	8,0	29,0	126,0
11891	5 G 0,75	19	8,8	36,0	140,0
11892	7 G 0,75	19	10,7	50,0	190,0
11893	12 G 0,75	19	13,1	86,0	257,0
11894	18 G 0,75	19	15,6	130,0	362,0
11895	25 G 0,75	19	18,9	180,0	486,0
11896	2 x 1	18	7,4	19,2	80,0
11897	3 G 1	18	8,0	29,2	96,0
11898	4 G 1	18	8,8	38,4	100,0
11899	5 G 1	18	9,8	48,0	130,0
11900	7 G 1	18	11,7	67,0	170,0
11901	12 G 1	18	14,5	115,0	290,0
11902	18 G 1	18	17,3	173,0	405,0
11903	25 G 1	18	21,1	240,0	570,0
11904	2 x 1,5	16	8,4	29,0	95,0
11905	3 G 1,5	16	9,1	43,0	112,0
11906	4 G 1,5	16	9,9	58,0	139,0
11907	5 G 1,5	16	11,0	72,0	170,0
11908	7 G 1,5	16	13,3	101,0	225,0
11909	12 G 1,5	16	16,6	173,0	370,0
11910	18 G 1,5	16	19,7	259,0	520,0
11911	25 G 1,5	16	23,9	360,0	730,0

Continuation ▶

JZ-600 UL/CSA

flexible, number coded, 1000 V, meter marking



Part no. Sheath colour	No. cores x cross-sec. mm ²	AWG-No.	Outer Ø app. mm	Cop. weight kg / km	Weight app. kg / km
11847	2 x 2,5	14	9,4	48,0	160,0
11848	3 G 2,5	14	9,9	72,0	175,0
11849	4 G 2,5	14	11,1	96,0	203,0
11850	5 G 2,5	14	12,4	120,0	251,0
11851	7 G 2,5	14	15,0	168,0	330,0
11852	12 G 2,5	14	18,4	288,0	553,0
11853	18 G 2,5	14	22,0	432,0	795,0
11854	25 G 2,5	14	26,9	600,0	1110,0
11855	2 x 4	12	11,4	77,0	180,0
11856	3 G 4	12	12,3	115,0	230,0
11857	4 G 4	12	13,8	154,0	310,0
11858	5 G 4	12	15,3	192,0	410,0
11859	7 G 4	12	16,8	269,0	540,0
11860	12 G 4	12	22,9	461,0	860,0
11861	3 G 6	10	14,1	173,0	370,0
11862	4 G 6	10	15,6	230,0	430,0
11863	5 G 6	10	17,3	288,0	650,0
11864	7 G 6	10	19,3	403,0	860,0
11865	3 G 10	8	16,5	288,0	660,0
11866	4 G 10	8	18,1	384,0	790,0
11867	5 G 10	8	20,5	480,0	960,0
11868	7 G 10	8	22,5	672,0	1300,0
11869	3 G 16	6	19,6	461,0	760,0
11870	4 G 16	6	21,7	614,0	1100,0
11871	5 G 16	6	24,2	768,0	1600,0
11872	7 G 16	6	25,7	1075,0	1890,0
11873	3 G 25	4	24,0	720,0	1450,0
11874	4 G 25	4	26,9	960,0	1600,0
11875	5 G 25	4	29,4	1200,0	2050,0
11876	7 G 25	4	32,8	1680,0	2900,0

Part no. Sheath colour	No. cores x cross-sec. mm ²	AWG-No.	Outer Ø app. mm	Cop. weight kg / km	Weight app. kg / km
11912	2 x 2,5	14	9,4	48,0	160,0
11913	3 G 2,5	14	9,9	72,0	175,0
11914	4 G 2,5	14	11,1	96,0	203,0
11915	5 G 2,5	14	12,4	120,0	251,0
11916	7 G 2,5	14	15,0	168,0	330,0
11917	12 G 2,5	14	18,4	288,0	553,0
11918	18 G 2,5	14	22,0	432,0	795,0
11919	25 G 2,5	14	26,9	600,0	1110,0
11920	2 x 4	12	11,4	77,0	180,0
11921	3 G 4	12	12,3	115,0	230,0
11922	4 G 4	12	13,8	154,0	310,0
11923	5 G 4	12	15,3	192,0	410,0
11924	7 G 4	12	16,8	269,0	540,0
11925	12 G 4	12	22,9	461,0	860,0
11926	3 G 6	10	14,1	173,0	370,0
11927	4 G 6	10	15,6	230,0	430,0
11928	5 G 6	10	17,3	288,0	650,0
11929	7 G 6	10	19,3	403,0	860,0
11930	3 G 10	8	16,5	288,0	660,0
11931	4 G 10	8	18,4	384,0	790,0
11932	5 G 10	8	20,5	480,0	960,0
11933	7 G 10	8	22,5	672,0	1300,0
11934	3 G 16	6	19,6	461,0	760,0
11935	4 G 16	6	21,7	614,0	1100,0
11936	5 G 16	6	24,2	768,0	1600,0
11937	7 G 16	6	25,7	1075,0	1890,0
11938	3 G 25	4	24,0	720,0	1450,0
11939	4 G 25	4	26,9	960,0	1600,0
11940	5 G 25	4	29,3	1200,0	2050,0
11941	7 G 25	4	32,6	1680,0	2900,0

Dimensions and specifications may be changed without prior notice. (RN01)

JZ-600-Y-CY UL/CSA

EMC-preferred type, number coded, 1000 V, Cu-screened, flexible, meter marking



Technical data

- Special PVC control cables adapted to DIN VDE 0276 part 627, DIN VDE 0285-525-2-51 / DIN EN 50525-2-51, with insulation thickness for 1 kV and to UL Std.758 Style 21179
- **Temperature range**
flexing -5°C to +80°C
fixed installation -40°C to +80°C
- **Nominal voltage**
VDE U₀/U 600/1000 V
UL/CSA 1000 V
- **Test voltage**
4000 V
- **Breakdown voltage**
min. 8000 V
- **Insulation resistance**
min. 20 MOhm x km
- **Minimum bending radius**
flexing 10x cable Ø
fixed installation 5x cable Ø
- **Radiation resistance**
up to 80x10⁶ cJ/kg (up to 80 Mrad)
- **Coupling resistance**
max. 250 Ohm/km

Cable structure

- Bare copper, fine wire conductors, acc. to DIN VDE 0295 cl.5, BS 6360 cl.5 and IEC 60228 cl.5
- Core insulation of special PVC compound type T12 to DIN VDE 0207-363-3 / DIN EN 50363-3 and class 43 acc. to UL Std.1581
- Core identification to DIN VDE 0293 black cores with continuous white numbering
- GN-YE conductor, 3 cores and above in the outer layer
- Cores stranded in layers with optimal lay length
- PVC-insulated inner sheath TM2, to DIN VDE 0207-363-4-1/DIN EN 50363-4-1, class 43 acc. to UL Std.1581
- Braided screen of tinned Cu wires, coverage approx. 85%
- Outer sheath of special PVC compound type TM2 to DIN VDE 0207-363-4-1/DIN EN 50363-4-1 and class 43 acc. to UL Std.1581
- Sheath colour: black (RAL 9005) or grey (RAL 7001)
- With meter marking

Properties

- Extensively oil resistant, oil-/chemical resistance see "Technical Informations"
- UV resistant (building with black sheath)
- The materials used during manufacturing are cadmium-free, contain no silicone and are free from substances harmful to the wetting properties of lacquers

Tests

- PVC self-extinguishing and flame retardant acc. to DIN VDE 0482-332-1-2, DIN EN 60332-1-2, IEC 60332-1-2 (equivalent DIN VDE 0472 part 804 test method B), UL VW-1, CSA FT1

Note

- G = with GN-YE conductor
x = without GN-YE conductor (OZ)
- AWG sizes are approximate equivalent values. The actual cross section is in mm².
- Unscreened analogue type:
JZ-600 UL/CSA

Application

PVC control cable for measuring, monitoring and control purposes in tool machinery, conveyor belts and production lines in machinery, in air conditioning, in foundries and steel mills. Suitable for installation for flexible use for medium mechanical stresses with free movement without tensile stress or forced movements in dry, moist and wet rooms as well as outside (fixed installation, building with black sheath). Is not suitable to be used as direct burial- or as underwater cable. Interference-free transmission of signals and pulses is assured by the high degree of screening.

EMC = Electromagnetic compatibility

To optimize the EMC features we recommend a large round contact of the copper braiding on both ends.

CE = Product conforms with Low-Voltage Directive 2014/35/EU.

Part no. Sheath colour	No.cores x cross-sec. mm ²	AWG-No.	Outer Ø app. mm	Cop. weight kg / km	Weight app. kg / km
black					
12345	2 x 0,5	20	8,3	41,0	129,0
12346	3 G 0,5	20	8,6	45,0	150,0
12347	4 G 0,5	20	9,4	54,0	170,0
12348	5 G 0,5	20	10,1	66,0	199,0
12349	7 G 0,5	20	12,1	79,0	235,0
12350	12 G 0,5	20	14,7	137,0	320,0
12351	18 G 0,5	20	17,3	156,0	428,0
12352	25 G 0,5	20	20,6	250,0	503,0
12353	2 x 0,75	19	8,7	46,0	143,0
12354	3 G 0,75	19	9,0	57,0	155,0
12355	4 G 0,75	19	9,9	63,0	190,0
12356	5 G 0,75	19	10,8	76,0	228,0
12357	7 G 0,75	19	13,0	100,0	323,0
12358	12 G 0,75	19	15,8	175,0	410,0
12359	18 G 0,75	19	17,9	240,0	560,0
12360	25 G 0,75	19	22,8	306,0	730,0
12361	2 x 1	18	9,4	54,0	150,0
12362	3 G 1	18	9,8	64,0	163,0
12363	4 G 1	18	10,8	76,0	200,0
12364	5 G 1	18	12,1	89,0	239,0
12365	7 G 1	18	14,5	114,0	289,0
12366	12 G 1	18	17,4	186,0	464,0
12367	18 G 1	18	20,7	284,0	628,0
12368	25 G 1	18	24,8	387,0	855,0
12369	2 x 1,5	16	10,2	64,0	162,0
12370	3 G 1,5	16	10,9	82,0	187,0
12371	4 G 1,5	16	12,2	99,0	240,0

Part no. Sheath colour	No.cores x cross-sec. mm ²	AWG-No.	Outer Ø app. mm	Cop. weight kg / km	Weight app. kg / km
grey					
12410	2 x 0,5	20	8,3	41,0	129,0
12411	3 G 0,5	20	8,6	45,0	150,0
12412	4 G 0,5	20	9,4	54,0	170,0
12413	5 G 0,5	20	10,1	66,0	199,0
12414	7 G 0,5	20	12,1	79,0	235,0
12415	12 G 0,5	20	14,7	137,0	320,0
12416	18 G 0,5	20	17,3	156,0	428,0
12417	25 G 0,5	20	20,6	250,0	503,0
12418	2 x 0,75	19	8,7	46,0	143,0
12419	3 G 0,75	19	9,0	57,0	155,0
12420	4 G 0,75	19	9,9	63,0	190,0
12421	5 G 0,75	19	10,8	76,0	228,0
12422	7 G 0,75	19	13,0	100,0	323,0
12423	12 G 0,75	19	15,8	175,0	410,0
12424	18 G 0,75	19	17,9	240,0	560,0
12425	25 G 0,75	19	22,8	306,0	730,0
12426	2 x 1	18	9,4	54,0	150,0
12427	3 G 1	18	9,8	64,0	163,0
12428	4 G 1	18	10,8	76,0	200,0
12429	5 G 1	18	12,1	89,0	239,0
12430	7 G 1	18	14,5	114,0	289,0
12431	12 G 1	18	17,4	186,0	464,0
12432	18 G 1	18	20,7	284,0	628,0
12433	25 G 1	18	24,8	387,0	855,0
12434	2 x 1,5	16	10,2	64,0	162,0
12435	3 G 1,5	16	10,9	82,0	187,0
12436	4 G 1,5	16	12,2	99,0	240,0

Continuation ▶

JZ-600-Y-CY UL/CSA

EMC-preferred type, number coded, 1000 V, Cu-screened, flexible, meter marking



Part no. Sheath colour	No. cores x cross-sec. mm ²	AWG-No.	Outer Ø app. mm	Cop. weight kg / km	Weight app. kg / km	Part no. Sheath colour	No. cores x cross-sec. mm ²	AWG-No.	Outer Ø app. mm	Cop. weight kg / km	Weight app. kg / km
black						grey					
12372	5 G 1,5	16	13,3	123,0	289,0	12437	5 G 1,5	16	13,3	123,0	289,0
12373	7 G 1,5	16	16,0	148,0	383,0	12438	7 G 1,5	16	16,0	148,0	383,0
12374	12 G 1,5	16	19,6	274,0	592,0	12439	12 G 1,5	16	19,6	274,0	592,0
12375	18 G 1,5	16	23,4	386,0	806,0	12440	18 G 1,5	16	23,4	386,0	806,0
12376	25 G 1,5	16	28,2	531,0	1241,0	12441	25 G 1,5	16	28,2	531,0	1241,0
12377	2 x 2,5	14	11,5	110,0	272,0	12442	2 x 2,5	14	11,5	110,0	272,0
12378	3 G 2,5	14	12,2	148,0	298,0	12443	3 G 2,5	14	12,2	148,0	298,0
12379	4 G 2,5	14	13,4	169,0	345,0	12444	4 G 2,5	14	13,4	169,0	345,0
12380	5 G 2,5	14	14,9	220,0	427,0	12445	5 G 2,5	14	14,9	220,0	427,0
12381	7 G 2,5	14	17,9	284,0	561,0	12446	7 G 2,5	14	17,9	284,0	561,0
12382	12 G 2,5	14	21,9	470,0	857,0	12447	12 G 2,5	14	21,9	470,0	857,0
12383	18 G 2,5	14	26,1	572,0	1355,0	12448	18 G 2,5	14	26,1	572,0	1355,0
12384	25 G 2,5	14	31,9	740,0	1995,0	12449	25 G 2,5	14	31,9	740,0	1995,0
12385	2 x 4	12	14,3	124,0	306,0	12450	2 x 4	12	14,3	124,0	306,0
12386	3 G 4	12	15,1	178,0	391,0	12451	3 G 4	12	15,1	178,0	391,0
12387	4 G 4	12	16,7	234,0	527,0	12452	4 G 4	12	16,7	234,0	527,0
12388	5 G 4	12	18,6	284,0	700,0	12453	5 G 4	12	18,6	284,0	700,0
12389	7 G 4	12	20,0	321,0	920,0	12454	7 G 4	12	20,0	321,0	920,0
12390	3 G 6	10	17,0	245,0	629,0	12455	3 G 6	10	17,0	245,0	629,0
12391	4 G 6	10	18,7	316,0	731,0	12456	4 G 6	10	18,7	316,0	731,0
12392	5 G 6	10	20,7	442,0	1105,0	12457	5 G 6	10	20,7	442,0	1105,0
12393	7 G 6	10	23,0	530,0	1465,0	12458	7 G 6	10	23,0	530,0	1465,0
12394	3 G 10	8	19,6	367,0	1125,0	12459	3 G 10	8	19,6	367,0	1125,0
12395	4 G 10	8	21,9	549,0	1345,0	12460	4 G 10	8	21,9	549,0	1345,0
12396	5 G 10	8	24,1	604,0	1635,0	12461	5 G 10	8	24,1	604,0	1635,0
12397	7 G 10	8	26,8	820,0	2210,0	12462	7 G 10	8	26,8	820,0	2210,0
12398	3 G 16	6	23,5	653,0	1395,0	12463	3 G 16	6	23,5	653,0	1395,0
12399	4 G 16	6	26,4	807,0	1870,0	12464	4 G 16	6	26,4	807,0	1870,0
12400	5 G 16	6	28,8	940,0	2720,0	12465	5 G 16	6	28,8	940,0	2720,0
12401	7 G 16	6	31,9	1345,0	3213,0	12466	7 G 16	6	31,9	1345,0	3213,0
12402	3 G 25	4	28,0	920,0	2465,0	12467	3 G 25	4	28,0	920,0	2465,0
12403	4 G 25	4	32,5	1169,0	2750,0	12468	4 G 25	4	32,5	1169,0	2750,0
12404	5 G 25	4	35,7	1420,0	3490,0	12469	5 G 25	4	35,7	1420,0	3490,0
12405	7 G 25	4	39,0	1921,0	4980,0	12470	7 G 25	4	39,0	1921,0	4980,0

Dimensions and specifications may be changed without prior notice. (RN01)

JZ-602

two approval control cable, 90°C, 600 V, oil resistant, meter marking

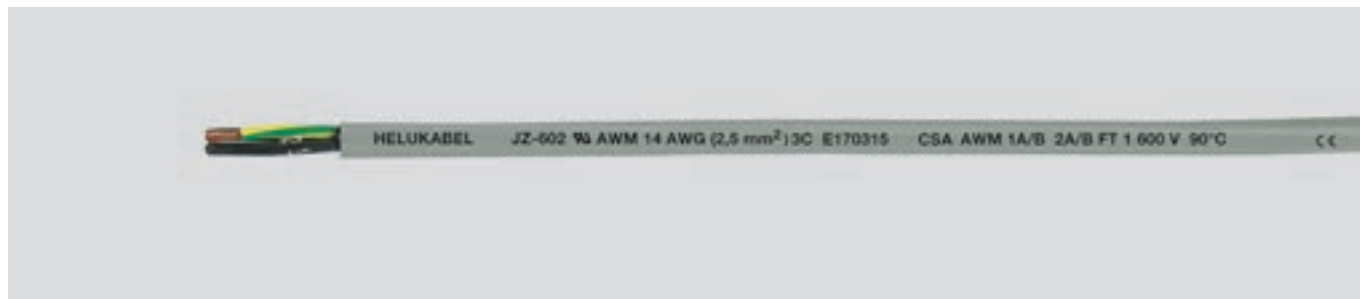

Technical data

- Control cable of special-PVC acc. to UL CSA AWM I/II A/B Style 2587 (sheath insulation) and CSA
- **Temperature range**
flexing -5°C to +90°C
fixed installation -40°C to +90°C
- **Nominal voltage**
UL/CSA 600 V
- **Test voltage**
3000 V
- **Breakdown voltage**
min. 6000 V
- **Insulation resistance**
min 20 MOhm x km
- **Minimum bending radius**
flexing 7,5x cable Ø
fixed installation 4x cable Ø
- **Radiation resistance**
up to 80x10⁶ cJ/kg (up to 80 Mrad)

Cable structure

- Bare copper conductor, to DIN VDE 0295 cl.5, fine wire, BS 6360 cl.5, IEC 60228 cl.5
- Core insulation of PVC compound type T13 to DIN VDE 0207-363-3 / DIN EN 50363-3 and class 43 acc. to UL Std.1581
- Core identification black cores with continuous white numbering
- GN-YE conductor, 3 cores and above in the outer layer
- Cores stranded in layers with optimal lay length
- Outer sheath of special PVC compound type YM5 to DIN VDE 0207 part 5 and class 43 acc. to UL Std.1581
- Sheath colour: grey (RAL 7001)
- With meter marking

Properties

- Resistant to mineral oils, synthetic oils and coolant
- The outer sheath is approved with an improved oil resistance test
- The materials used during manufacturing are cadmium-free, contain no silicone and are free from substances harmful to the wetting properties of lacquers

Tests

- PVC self-extinguishing and flame retardant acc. to DIN VDE 0482-332-1-2, DIN EN 60332-1-2, IEC 60332-1-2 (equivalent DIN VDE 0472 part 804 test method B), UL VW-1, CSA FT1

Note

- G = with GN-YE conductor
x = without GN-YE conductor (OZ)
- Please note "cleanroom qualified" when ordering.
- AWG sizes are approximate equivalent values. The actual cross section is in mm².
- Screened analogue type:
JZ-602-CY

Application

UL-approved and CSA certified flexible control cable rated at 600 V. Used in machine tools, control systems, connection between control panels and machines, assembly lines and other industrial equipment. Suitable for installation in dry, moist or wet environment and moderate flexing applications.

☑️ = Product conforms with Low-Voltage Directive 2014/35/EU.

Part no.	No. cores x cross-sec. mm ²	AWG-No.	Outer Ø app. mm	Cop. weight kg / km	Weight app. kg / km
83090	2 x 0,5	20	5,6	9,6	49,0
83091	3 G 0,5	20	5,9	14,0	58,0
83092	4 G 0,5	20	6,4	19,0	69,0
83093	5 G 0,5	20	6,9	24,0	84,0
83094	7 G 0,5	20	7,5	34,0	123,0
83100	8 G 0,5	20	8,3	38,4	140,0
83101	9 G 0,5	20	8,9	43,2	177,0
83095	12 G 0,5	20	9,8	58,0	192,0
83096	18 G 0,5	20	12,0	86,0	256,0
83097	25 G 0,5	20	14,3	120,0	358,0
83098	34 G 0,5	20	16,5	163,0	487,0
83099	41 G 0,5	20	17,9	197,0	580,0
83080	2 x 1	18	6,3	19,2	53,0
83081	3 G 1	18	6,6	27,0	61,0
83082	4 G 1	18	7,2	38,4	74,0
83565	3 x 1	18	6,6	27,0	61,0
83083	5 G 1	18	7,9	48,0	90,0
83084	7 G 1	18	8,7	67,0	130,0
83102	8 G 1	18	9,5	76,8	144,0
83103	9 G 1	18	10,4	86,4	180,0
83085	12 G 1	18	11,2	115,2	198,0
83086	18 G 1	18	14,1	173,0	274,0
83087	25 G 1	18	16,8	240,0	384,0
83088	34 G 1	18	19,5	326,0	494,0
83089	41 G 1	18	21,2	394,0	508,0
83070	2 x 1,5	16	6,8	28,8	73,0
83071	3 G 1,5	16	7,2	44,0	94,0
83072	4 G 1,5	16	7,9	58,0	117,0
83073	5 G 1,5	16	8,7	72,0	140,0
83074	7 G 1,5	16	9,7	101,0	186,0

Part no.	No. cores x cross-sec. mm ²	AWG-No.	Outer Ø app. mm	Cop. weight kg / km	Weight app. kg / km
83104	9 G 1,5	16	11,5	129,7	244,0
83075	12 G 1,5	16	12,6	173,0	319,0
83076	18 G 1,5	16	15,8	260,0	451,0
83077	25 G 1,5	16	18,3	360,0	625,0
83078	34 G 1,5	16	21,4	490,0	840,0
83079	41 G 1,5	16	23,3	590,0	1032,0
83060	2 x 2,5	14	7,8	48,0	115,0
83061	3 G 2,5	14	8,5	72,0	143,0
83062	4 G 2,5	14	9,3	96,0	185,0
83063	5 G 2,5	14	10,4	120,0	221,0
83064	7 G 2,5	14	11,5	168,0	293,0
83065	9 G 2,5	14	13,9	216,0	429,0
83066	12 G 2,5	14	15,2	288,0	563,0
83067	18 G 2,5	14	18,7	432,0	854,0
83068	19 G 2,5	14	18,7	456,0	914,0
83069	25 G 2,5	14	22,2	600,0	1188,0
83051	3 G 4	12	9,7	115,0	232,0
83052	4 G 4	12	10,6	154,0	298,0
83053	5 G 4	12	11,8	192,0	358,0
83054	7 G 4	12	13,1	269,0	460,0
83041	3 G 6	10	11,3	173,0	360,0
83042	4 G 6	10	12,5	231,0	402,0
83043	5 G 6	10	13,9	288,0	484,0
83044	7 G 6	10	15,4	403,0	630,0
83031	3 G 10	8	14,7	288,0	535,0
83032	4 G 10	8	16,3	384,0	653,0
83033	5 G 10	8	18,3	480,0	786,0
83034	7 G 10	8	20,2	672,0	1100,0

Continuation ▶

JZ-602

two approval control cable, 90°C, 600 V, oil resistant, meter marking



Part no.	No. cores x cross-sec. mm ²	AWG-No.	Outer Ø app. mm	Cop. weight kg / km	Weight app. kg / km
83020	2 x 16	6	18,8	307,0	640,0
83021	3 G 16	6	20,2	461,0	810,0
83022	4 G 16	6	22,3	615,0	1045,0
83023	5 G 16	6	24,9	768,0	1260,0
83024	7 G 16	6	27,5	1075,0	1760,0
83011	3 G 25	4	24,0	720,0	1180,0
83012	4 G 25	4	26,9	960,0	1507,0
83013	5 G 25	4	31,9	1200,0	1858,0
83014	7 G 25	4	33,0	1680,0	2830,0
83001	3 G 35	2	26,2	1008,0	1590,0
83002	4 G 35	2	29,7	1344,0	2123,0
83003	5 G 35	2	33,0	1680,0	2612,0

Part no.	No. cores x cross-sec. mm ²	AWG-No.	Outer Ø app. mm	Cop. weight kg / km	Weight app. kg / km
83004	3 G 50	1	31,9	1440,0	2652,0
83005	4 G 50	1	35,6	1920,0	3058,0
83006	5 G 50	1	39,7	2400,0	4093,0
83007	3 G 70	2/0	36,8	2016,0	3307,0
83008	4 G 70	2/0	40,9	2688,0	4254,0
83009	5 G 70	2/0	45,6	3360,0	5661,0
83010	3 G 95	3/0	40,9	2736,0	4867,0
83015	4 G 95	3/0	45,6	3648,0	5762,0
83016	5 G 95	3/0	50,7	4560,0	7208,0
83017	3 G 120	4/0	48,1	3456,0	5580,0
83018	4 G 120	4/0	53,3	4608,0	7280,0
83019	5 G 120	4/0	58,9	5760,0	8692,0

Dimensions and specifications may be changed without prior notice. (RN01)

JZ-602-CY

screened two approval control cable, oil resistant, EMC-preferred type, 90°C, 600 V, meter marking



Technical data

- Control cable of special-PVC acc. to UL CSA AWM I/II A/B Style 2587 (sheath insulation) and CSA
- **Temperature range** flexing -5°C to +90°C fixed installation -40°C to +90°C
- **Nominal voltage** UL/CSA 600 V
- **Test voltage** 3000 V
- **Breakdown voltage** min. 6000 V
- **Insulation resistance** min. 20 MOhm x km
- **Minimum bending radius** flexing 10x cable Ø fixed installation 5x cable Ø
- **Radiation resistance** up to 80x10⁶ cJ/kg (up to 80 Mrad)
- **Coupling resistance** max. 250 Ohm/km

Cable structure

- Bare copper, fine wire stranded to DIN VDE 0295 cl.5, BS 6360 cl.5 and IEC 60228 cl.5
- Core insulation of PVC compound type T13 to DIN VDE 0207-363-3 / DIN EN 50363-3 and class 43 acc. to UL Std.1581
- Core identification to DIN VDE 0293 black cores with continuous white numbering
- GN-YE conductor, 3 cores and above in the outer layer
- Cores stranded in layers with optimal lay length
- PVC-insulated inner sheath YM5 to DIN VDE 0207 part 5
- Braided screen of tinned Cu wires approx. 85% coverage
- Outer sheath of special PVC compound type YM5 to DIN VDE 0207 part 5 and class 43 acc. to UL Std.1581
- Sheath colour: grey (RAL 7001)
- With meter marking

Properties

- Resistant to mineral oils, synthetic oils and coolant
- The outer sheath is approved with an improved oil resistance test
- The materials used during manufacturing are cadmium-free, contain no silicone and are free from substances harmful to the wetting properties of lacquers

Tests

- PVC self-extinguishing and flame retardant acc. to DIN VDE 0482-332-1-2, DIN EN 60332-1-2, IEC 60332-1-2 (equivalent DIN VDE 0472 part 804 test method B), UL VW-1, CSA FT1

Note

- G = with GN-YE conductor
x = without GN-YE conductor (OZ)
- Cleanroom qualification tested with analog type. Please note "cleanroom qualified" when ordering.
- AWG sizes are approximate equivalent values. The actual cross section is in mm².
- Unscreened analogue type:
JZ-602

Application

UL and CSA approved flexible control cables up to 600 V, for all machinery in tooling and plant construction, suitable for installation in dry, moist or wet environments for medium mechanical loads. Designed for the export-orientated machinery manufacturer, specifically for USA and Canada. The thick braiding screen ensures compliance with electromagnetic requirements.

EMC = Electromagnetic compatibility

To optimize the EMC features we recommend a large round contact of the copper braiding on both ends.

= Product conforms with Low-Voltage Directive 2014/35/EU.

Part no.	No. cores x cross-sec. mm ²	AWG-No.	Outer Ø app. mm	Cop. weight kg / km	Weight app. kg / km
82990	2 x 0,5	20	7,4	35,0	93,0
82991	3 G 0,5	20	7,7	42,0	124,0
82992	4 G 0,5	20	8,2	47,0	133,0
82993	5 G 0,5	20	9,0	56,0	153,0
82994	7 G 0,5	20	9,6	69,0	191,0
82995	9 G 0,5	20	11,2	87,0	243,0
82996	12 G 0,5	20	12,3	108,0	322,0
82997	18 G 0,5	20	14,7	145,0	374,0
82998	25 G 0,5	20	17,0	240,0	436,0
82999	34 G 0,5	20	21,4	312,0	560,0
83000	41 G 0,5	20	21,4	348,0	663,0
82979	2 x 1	18	8,1	50,0	107,0
82980	3 G 1	18	8,5	60,0	130,0
82981	4 G 1	18	9,2	71,0	155,0
82982	5 G 1	18	10,1	88,0	181,0
82983	7 G 1	18	10,8	111,0	209,0
82984	9 G 1	18	12,7	139,0	321,0
82985	12 G 1	18	14,1	184,0	341,0
82986	18 G 1	18	16,6	260,0	473,0
82987	25 G 1	18	19,7	349,0	650,0
82988	34 G 1	18	22,6	486,0	781,0

Part no.	No. cores x cross-sec. mm ²	AWG-No.	Outer Ø app. mm	Cop. weight kg / km	Weight app. kg / km
82989	41 G 1	18	24,7	531,0	892,0
82968	2 x 1,5	16	8,6	63,0	136,0
82969	3 G 1,5	16	9,2	80,0	165,0
82970	4 G 1,5	16	10,0	97,0	192,0
82971	5 G 1,5	16	11,0	119,0	224,0
82972	7 G 1,5	16	11,8	147,0	273,0
82973	9 G 1,5	16	14,0	182,0	340,0
82974	12 G 1,5	16	15,3	267,0	461,0
82975	18 G 1,5	16	18,5	374,0	674,0
82976	25 G 1,5	16	21,8	526,0	950,0
82977	34 G 1,5	16	25,2	629,0	1203,0
82978	41 G 1,5	16	27,6	801,0	1588,0
82959	2 x 2,5	14	10,1	96,0	173,0
82960	3 G 2,5	14	10,6	144,0	220,0
82961	4 G 2,5	14	11,6	148,0	270,0
82962	5 G 2,5	14	12,7	181,0	329,0
82963	7 G 2,5	14	14,0	255,0	428,0
82964	9 G 2,5	14	16,4	309,0	580,0
82965	12 G 2,5	14	18,1	441,0	761,0
82966	18 G 2,5	14	22,2	570,0	1140,0
82967	25 G 2,5	14	27,0	738,0	1551,0

Continuation ▶

JZ-602-CY

screened two approval control cable, oil resistant, EMC-preferred type,
90°C, 600 V, meter marking



Part no.	No. cores x cross-sec. mm ²	AWG-No.	Outer Ø app. mm	Cop. weight kg / km	Weight app. kg / km
82954	2 x 4	12	11,2	120,0	209,0
82955	3 G 4	12	11,9	174,0	310,0
82956	4 G 4	12	13,3	230,0	456,0
82957	5 G 4	12	14,6	273,0	532,0
82958	7 G 4	12	15,9	316,0	737,0
82949	2 x 6	10	12,9	173,0	318,0
82950	3 G 6	10	14,0	240,0	411,0
82951	4 G 6	10	15,4	305,0	572,0
82952	5 G 6	10	17,0	439,0	732,0
82953	7 G 6	10	18,3	505,0	961,0
82945	3 G 10	8	16,3	350,0	741,0
82946	4 G 10	8	19,4	535,0	988,0
82947	5 G 10	8	21,6	592,0	1202,0
82948	7 G 10	8	23,9	810,0	1743,0
82941	3 G 16	6	23,9	585,0	1088,0
82942	4 G 16	6	26,4	740,0	1662,0
82943	5 G 16	6	29,6	895,0	2021,0
82944	7 G 16	6	32,6	1282,0	2720,0

Part no.	No. cores x cross-sec. mm ²	AWG-No.	Outer Ø app. mm	Cop. weight kg / km	Weight app. kg / km
82937	3 G 25	4	28,3	1070,0	1947,0
82938	4 G 25	4	31,4	1140,0	2591,0
82939	5 G 25	4	34,6	1380,0	3197,0
82940	7 G 25	4	38,1	1870,0	4530,0
82934	3 G 35	2	31,3	1240,0	2701,0
82935	4 G 35	2	34,4	1576,0	3277,0
82936	5 G 35	2	38,1	1930,0	4530,0
82488	3 G 50	1	37,0	1675,0	2870,0
82780	4 G 50	1	40,9	2155,0	3960,0
82781	5 G 50	1	45,0	2794,0	4371,0
82782	3 G 70	2/0	42,1	2288,0	3647,0
82783	4 G 70	2/0	46,2	3120,0	4882,0
82914	5 G 70	2/0	50,9	3705,0	5876,0
82915	3 G 95	3/0	46,2	3010,0	4751,0
82916	4 G 95	3/0	50,0	4043,0	6368,0
82917	5 G 95	3/0	56,0	5026,0	7843,0
82918	3 G 120	4/0	52,8	3812,0	5899,0
82919	4 G 120	4/0	58,2	5069,0	8010,0
82920	5 G 120	4/0	63,8	5877,0	9205,0

Dimensions and specifications may be changed without prior notice. (RN01)

JZ-603

Multi approval control cable, oil resistant, meter marking



Technical data

- Special PVC control cable with oil resistant outer sheath to DIN VDE 0285-525-2-51/ DIN EN 50525-2-51 and UL Style 2587
- **Temperature range**
HAR
flexing -5°C to +70°C
fixed installation -40°C to +70°C
UL/CSA
flexing -5°C to +90°C
fixed installation -40°C to +90°C
- **Nominal voltage**
HAR U₀/U 300/500 V
UL/CSA 600 V
- **Test voltage**
3000 V
- **Breakdown voltage**
min. 6000 V
- **Insulation resistance**
min. 20 MOhm x km
- **Minimum bending radius**
flexing 7,5x cable Ø
fixed installation 4x cable Ø
- **Radiation resistance**
up to 80x10⁶ cJ/kg (up to 80 Mrad)

Cable structure

- Bare copper conductor, to DIN VDE 0295 cl.5, fine wire, BS 6360 cl.5, IEC 60228 cl.5
- Core insulation of special PVC compound type T12 to DIN VDE 0207-363-3 / DIN EN 50363-3 and class 43 acc. to UL Std.1581
- Core identification to DIN VDE 0293 black cores with continuous white numbering
- GN-YE conductor, 3 cores and above in the outer layer
- Cores stranded in layers with optimal lay length
- Outer sheath of oil resistant special PVC compound type TM5 to DIN VDE 0207-363-4-1/DIN EN 50363-4-1 and class 43 acc. to UL Std.1581
- Sheath colour: grey (RAL 7001)
- With meter marking

Properties

- The materials used during manufacturing are cadmium-free, contain no silicone and are free from substances harmful to the wetting properties of lacquers

Tests

- PVC self-extinguishing and flame retardant acc. to DIN VDE 0482-332-1-2, DIN EN 60332-1-2, IEC 60332-1-2 (equivalent DIN VDE 0472 part 804 test method B), UL VW-1, CSA FT1
- Oil resistant to DIN VDE 0473-811-404/ DIN EN 60811-404, UL-Std.1581 part 50.182

Note

- G = with GN-YE conductor
x = without GN-YE conductor (OZ)
- AWG sizes are approximate equivalent values. The actual cross section is in mm².
- Screened analogue type:
JZ-603-CY

Application

UL-CSA-HAR approved cables offer any company exporting anywhere in the world, primarily designed for exporters, used in machine tools, control systems, assembly lines and other industrial equipment. These cables are suitable for flexible use for mechanical stresses with free movements in dry, moist and wet rooms but not for open air.

☑️ = Product conforms with Low-Voltage Directive 2014/35/EU.

Part no.	No. cores x cross-sec. mm ²	AWG-No.	Outer Ø app. mm	Cop. weight kg / km	Weight app. kg / km
83704	2 x 0,5	20	5,8	9,6	52,0
83650	3 G 0,5	20	6,1	14,0	63,0
83651	4 G 0,5	20	6,7	19,0	69,0
83652	5 G 0,5	20	7,3	24,0	87,0
83653	7 G 0,5	20	8,8	34,0	119,0
83654	12 G 0,5	20	11,1	58,0	198,0
83655	18 G 0,5	20	12,9	86,0	266,0
83656	25 G 0,5	20	16,0	120,0	380,0
83657	34 G 0,5	20	17,7	163,0	508,0
83658	41 G 0,5	20	19,5	197,0	594,0
83659	50 G 0,5	20	21,3	240,0	715,0
83660	61 G 0,5	20	23,8	293,0	840,0
83705	2 x 0,75	19	6,1	14,4	66,0
83661	3 G 0,75	19	6,5	22,0	76,0
83662	4 G 0,75	19	7,1	29,0	85,0
83663	5 G 0,75	19	7,9	36,0	113,0
83664	7 G 0,75	19	9,5	50,0	144,0
83665	12 G 0,75	19	11,6	86,0	245,0
83666	18 G 0,75	19	13,9	130,0	327,0
83667	25 G 0,75	19	17,1	180,0	466,0
83668	34 G 0,75	19	19,1	245,0	626,0
83669	41 G 0,75	19	20,9	296,0	747,0
83670	50 G 0,75	19	23,0	360,0	896,0
83671	61 G 0,75	19	25,3	439,0	1070,0
83706	2 x 1	18	6,4	19,2	70,0
83672	3 G 1	18	6,8	29,0	88,0
83673	4 G 1	18	7,5	39,0	99,0
83674	5 G 1	18	8,4	48,0	132,0
83675	7 G 1	18	10,0	67,0	170,0
83676	12 G 1	18	12,5	115,0	285,0

Part no.	No. cores x cross-sec. mm ²	AWG-No.	Outer Ø app. mm	Cop. weight kg / km	Weight app. kg / km
83677	18 G 1	18	14,7	173,0	405,0
83678	25 G 1	18	18,0	240,0	570,0
83679	34 G 1	18	20,3	326,0	742,0
83680	41 G 1	18	22,4	394,0	885,0
83681	50 G 1	18	24,3	480,0	1071,0
83682	61 G 1	18	26,8	586,0	1265,0
83707	2 x 1,5	16	7,4	28,8	91,0
83683	3 G 1,5	16	8,0	43,0	110,0
83684	4 G 1,5	16	8,7	58,0	141,0
83685	5 G 1,5	16	9,8	72,0	167,0
83686	7 G 1,5	16	11,9	101,0	225,0
83687	12 G 1,5	16	14,5	173,0	361,0
83688	18 G 1,5	16	17,4	259,0	518,0
83689	25 G 1,5	16	21,3	360,0	730,0
83690	34 G 1,5	16	24,1	490,0	945,0
83691	41 G 1,5	16	26,2	591,0	1135,0
83692	50 G 1,5	16	28,8	720,0	1381,0
83693	61 G 1,5	16	31,5	878,0	1640,0
83708	2 x 2,5	14	9,1	48,0	125,0
83694	3 G 2,5	14	9,9	72,0	169,0
83695	4 G 2,5	14	11,0	96,0	209,0
83696	5 G 2,5	14	12,0	120,0	256,0
83697	7 G 2,5	14	14,6	168,0	340,0
83698	12 G 2,5	14	18,1	288,0	579,0
83699	18 G 2,5	14	22,1	432,0	851,0
83700	25 G 2,5	14	26,5	600,0	1175,0
83701	34 G 2,5	14	29,9	816,0	1529,0
83702	50 G 2,5	14	35,2	1200,0	2290,0
83703	61 G 2,5	14	38,4	1464,0	2724,0

Dimensions and specifications may be changed without prior notice. (RN01)

JZ-603-CY

Multi approval control cable, oil resistant, Cu-screened,
EMC-preferred, meter marking



Technical data

- Special PVC control cable with oil resistant outer sheath to DIN VDE 0285-525-2-51, DIN EN 50525-2-51 and to UL Style 2587
- **Temperature range**
HAR
flexing -5°C to +70°C
fixed installation -40°C to +70°C
UL/CSA
flexing -5°C to +90°C
fixed installation -40°C to +90°C
- **Nominal voltage**
HAR U₀/U 300/500 V
UL/CSA 600 V
- **Test voltage**
3000 V
- **Breakdown voltage**
min. 6000 V
- **Insulation resistance**
min. 20 MOhm x km
- **Minimum bending radius**
flexing 10x cable Ø
fixed installation 5x cable Ø
- **Radiation resistance**
up to 80x10⁶ cJ/kg (up to 80 Mrad)
- **Coupling resistance**
max. 250 Ohm/km

Cable structure

- Bare copper, fine wire conductor to DIN VDE 0295 cl.5, BS 6360 cl.5 and IEC 60228 cl.5
- Core insulation of special PVC compound type T12 to DIN VDE 0207-363-3 / DIN EN 50363-3 and class 43 acc. to UL Std.1581
- Core identification to DIN VDE 0293 black cores with continuous white numbering
- GN-YE conductor, 3 cores and above in the outer layer
- Cores stranded in layers with optimal lay length
- PVC based inner sheath
- Tinned copper braiding screening, 85% coverage
- Outer sheath of special PVC, oil resistant compound type TM5 to DIN VDE 0207-363-4-1/DIN EN 50363-4-1 and class 43 acc. to UL Std.1581
- Sheath colour: grey (RAL 7001)
- With meter marking

Properties

- Oil resistant to DIN VDE 0473-811-404/ DIN EN 60811-404, UL 1581 part 50.182
- The materials used during manufacturing are cadmium-free, contain no silicone and are free from substances harmful to the wetting properties of lacquers

Tests

- PVC self-extinguishing and flame retardant acc. to DIN VDE 0482-332-1-2, DIN EN 60332-1-2, IEC 60332-1-2 (equivalent DIN VDE 0472 part 804 test method B), UL VW-1, CSA FT1

Note

- G = with GN-YE conductor
x = without GN-YE conductor (OZ)
- AWG sizes are approximate equivalent values. The actual cross section is in mm².
- Unscreened analogue type:
JZ-603

Application

UL-CSA-HAR approved cables offer any company exporting anywhere in the world, primarily designed for exporters, used in machine tools, control systems, assembly lines and other industrial equipment. These cables are suitable for flexible use for medium mechanical stresses with free movements in dry, moist and wet rooms but not for open air.

EMC = Electromagnetic compatibility

To optimize the EMC features we recommend a large round contact of the copper braiding on both ends.

☑ = Product conforms with Low-Voltage Directive 2014/35/EU.

Part no.	No. cores x cross-sec. mm ²	AWG-No.	Outer Ø app. mm	Cop. weight kg / km	Weight app. kg / km
83709	2 x 0,5	20	8,0	41,0	90,0
83720	3 G 0,5	20	8,3	45,0	105,0
83721	4 G 0,5	20	8,9	54,0	123,0
83722	5 G 0,5	20	9,7	66,0	147,0
83723	7 G 0,5	20	11,2	79,0	195,0
83724	12 G 0,5	20	13,6	137,0	276,0
83725	18 G 0,5	20	15,4	156,0	418,0
83726	25 G 0,5	20	18,6	250,0	504,0
83727	34 G 0,5	20	20,8	316,0	632,0
83728	41 G 0,5	20	22,6	348,0	750,0
83729	50 G 0,5	20	24,8	407,0	968,0
83730	61 G 0,5	20	26,0	520,0	1068,0
83710	2 x 0,75	19	8,3	46,0	101,0
83731	3 G 0,75	19	8,6	57,0	127,0
83732	4 G 0,75	19	9,4	63,0	155,0
83733	5 G 0,75	19	10,1	76,0	180,0
83734	7 G 0,75	19	11,9	100,0	225,0
83735	12 G 0,75	19	14,2	175,0	326,0
83736	18 G 0,75	19	16,6	240,0	457,0
83737	25 G 0,75	19	20,0	306,0	635,0
83738	34 G 0,75	19	22,4	346,0	805,0
83739	41 G 0,75	19	24,0	403,0	908,0
83740	50 G 0,75	19	26,2	470,0	1155,0
83741	61 G 0,75	19	30,0	550,0	1400,0

Part no.	No. cores x cross-sec. mm ²	AWG-No.	Outer Ø app. mm	Cop. weight kg / km	Weight app. kg / km
83711	2 x 1	18	8,6	54,0	113,0
83742	3 G 1	18	9,2	64,0	144,0
83743	4 G 1	18	9,8	76,0	178,0
83744	5 G 1	18	10,7	89,0	205,0
83745	7 G 1	18	12,5	114,0	263,0
83746	12 G 1	18	15,1	186,0	424,0
83747	18 G 1	18	17,3	284,0	560,0
83748	25 G 1	18	21,1	387,0	760,0
83749	34 G 1	18	23,5	500,0	945,0
83750	41 G 1	18	25,5	578,0	1151,0
83751	50 G 1	18	27,6	681,0	1300,0
83752	61 G 1	18	32,4	710,0	1500,0
83712	2 x 1,5	16	9,6	64,0	144,0
83753	3 G 1,5	16	10,1	82,0	160,0
83754	4 G 1,5	16	11,0	99,0	210,0
83755	5 G 1,5	16	12,3	123,0	240,0
83756	7 G 1,5	16	14,2	148,0	305,0
83757	12 G 1,5	16	17,1	274,0	482,0
83758	18 G 1,5	16	20,0	386,0	611,0
83759	25 G 1,5	16	24,0	531,0	950,0
83760	34 G 1,5	16	27,1	671,0	1200,0
83761	41 G 1,5	16	29,7	840,0	1400,0
83762	50 G 1,5	16	31,8	997,0	1665,0
83763	61 G 1,5	16	34,6	1120,0	1852,0

Continuation ▶

JZ-603-CY

Multi approval control cable, oil resistant, Cu-screened,
EMC-preferred, meter marking



Part no.	No. cores x cross-sec. mm ²	AWG-No.	Outer Ø app. mm	Cop. weight kg / km	Weight app. kg / km
83713	2 x 2,5	14	11,4	110,0	189,0
83764	3 G 2,5	14	12,0	148,0	244,0
83765	4 G 2,5	14	13,4	169,0	296,0
83766	5 G 2,5	14	14,6	220,0	367,0
83767	7 G 2,5	14	17,2	284,0	478,0
83768	12 G 2,5	14	21,2	470,0	622,0

Part no.	No. cores x cross-sec. mm ²	AWG-No.	Outer Ø app. mm	Cop. weight kg / km	Weight app. kg / km
83769	18 G 2,5	14	24,8	572,0	1010,0
83770	25 G 2,5	14	29,8	740,0	1375,0
83771	34 G 2,5	14	33,4	1179,0	1893,0
83772	50 G 2,5	14	39,0	1660,0	2666,0
83773	61 G 2,5	14	41,0	1992,0	3077,0

Dimensions and specifications may be changed without prior notice. (RN01)

H07RN-F

rubber-sheathed cable



Technical data

- Rubber sheathed cable H07RN-F to DIN VDE 0285-525-2-21, BS 7919 DIN EN 50525-2-21, IEC 60245-4
- **Temperature range**
flexing -25°C bis +60°C
fixed installation -30°C bis +60°C
- Permissible conductor **operating temperature** +60°C
- **Nominal voltage**
U₀/U 450/750 V
in case of protected and fixed installation
U₀/U 600/1000 V
- Max. permissible **operating voltage** in three phase and one phase a.c. system
U₀/U 476/825 V
direct current-system
U₀/U 619/1238 V
- **Test voltage**
2500 V
- **Permanent tensile load**
max. 15 N/mm²
- **Minimum bending radius**
for fixed installation 4x cable Ø
for guiding over roller 7,5x cable Ø
during winding on drums 5x cable Ø

Cable structure

- Bare copper conductor, to DIN VDE 0295 cl.5, fine wire, BS 6360 cl.5, IEC 60228 cl.5
- Core insulation of rubber EI4 to DIN VDE 0207-363-1 / DIN EN 50363-1
- Core identification to DIN VDE 0293-308
- up to 5 cores coloured
- from 6 cores, black with continuous white numbering
- GN-YE conductor, 3 cores and above
- Cores stranded in layers with optimal lay length
- Outer sheath of rubber EM2 to DIN VDE 0207-363-2-1/DIN EN 50363-2-1
- Sheath colour: black

Properties

Resistant to

- Weather

Tests

- Self-extinguishing and flame retardant acc. to DIN VDE 0482-332-1-2, DIN EN 60332-1-2, IEC 60332-1-2 (equivalent DIN VDE 0472 part 804 test method B)
- Ozone resistant of the insulation to DIN VDE 0473-396, DIN EN 50396
- Oil resistant test acc. to DIN VDE 0473-811-404, DIN EN 60811-404

Note

- G = with GN-YE conductor
x = without GN-YE conductor
- AWG sizes are approximate equivalent values. The actual cross section is in mm².
- The core identification of a single core sheathed, of an insulated wire is black.
- adapted to VDE with designation **07RN-F**
- Part.-no. 37094, 19G1,5 mm²
- Part.-no. 37098, 19G2,5 mm²
- Part.-no. 34349, 5G120 mm²
- Part.-no. 34127, 5G150 mm²

Application

Heavy duty rubber-sheathed flexible cables are suited for use for medium mechanical stress in dry, damp and wet areas as well as in open air and in agriculture plants. They are used for equipment in industry works such as boilers, heating plates, hand lamps, electric tools such as drills, circular saws and homework tools as well as for transportable motors or machines at site. These cables are also suitable for fixed installation on plaster, in temporary buildings and residential barracks. They are suitable for direct laying on components and mechanical parts of machines, for example lifts and cranes. They can be used in case of protected and fixed installation in tubes or in equipment as well as rotor connecting cable of motors with a working voltage up to 1000 V alternating voltage or a direct voltage up to 750 V against ground.

☑ = Product conforms with Low-Voltage Directive 2014/35/EU.

Part no.	No. cores x cross-sec. mm ²	Outer Ø min. - max. mm	Cop. weight kg / km	Weight app. kg / km	AWG-No.
37001	1 x 1,5	5,7 - 7,1	14,4	58,0	16
37002	1 x 2,5	6,3 - 7,9	24,0	71,0	14
37003	1 x 4	7,2 - 9,0	38,0	100,0	12
37004	1 x 6	7,9 - 9,8	58,0	130,0	10
37005	1 x 10	9,5 - 11,9	96,0	230,0	8
37006	1 x 16	10,8 - 13,4	154,0	290,0	6
37007	1 x 25	12,7 - 15,8	240,0	420,0	4
37008	1 x 35	14,3 - 17,9	336,0	530,0	2
37009	1 x 50	16,5 - 20,6	480,0	750,0	1
37010	1 x 70	18,6 - 23,3	672,0	960,0	2/0
37011	1 x 95	20,8 - 26,0	912,0	1250,0	3/0
37012	1 x 120	22,8 - 28,6	1152,0	1560,0	4/0
37013	1 x 150	25,2 - 31,4	1440,0	1900,0	300 kcmil
37014	1 x 185	27,6 - 34,4	1776,0	2300,0	350 kcmil
37015	1 x 240	30,6 - 38,3	2304,0	2950,0	500 kcmil
37016	1 x 300	33,5 - 41,9	2880,0	3600,0	600 kcmil
37017	1 x 400	37,4 - 46,8	3840,0	4600,0	750 kcmil
37018	1 x 500	41,3 - 52,0	4800,0	6000,0	1000 kcmil

Part no.	No. cores x cross-sec. mm ²	Outer Ø min. - max. mm	Cop. weight kg / km	Weight app. kg / km	AWG-No.
37019	2 x 1	7,7 - 10,0	19,0	98,0	18
37020	2 x 1,5	8,5 - 11,0	29,0	135,0	16
37021	2 x 2,5	10,2 - 13,1	48,0	193,0	14
37022	2 x 4	11,8 - 15,1	77,0	280,0	12
37023	2 x 6	13,1 - 16,8	115,0	330,0	10
37024	2 x 10	17,7 - 22,6	192,0	586,0	8
37025	2 x 16	20,2 - 25,7	307,0	810,0	6
37026	2 x 25	24,3 - 30,7	480,0	1160,0	4

Continuation ▶

H07RN-F

rubber-sheathed cable



Part no.	No. cores x cross-sec. mm ²	Outer Ø min. - max. mm	Cop. weight kg / km	Weight app. kg / km	AWG-No.
37027	3 G 1	8,3 - 10,7	29,0	130,0	18
37028	3 G 1,5	9,2 - 11,9	43,0	165,0	16
37029	3 G 2,5	10,9 - 14,0	72,0	235,0	14
37030	3 G 4	12,7 - 16,2	115,0	320,0	12
37031	3 G 6	14,1 - 18,0	173,0	420,0	10
37032	3 G 10	19,1 - 24,2	288,0	810,0	8
37033	3 G 16	21,8 - 27,6	461,0	1050,0	6
37034	3 G 25	26,1 - 33,0	720,0	1250,0	4
37035	3 G 35	29,3 - 37,1	1008,0	1900,0	2
37036	3 G 50	34,1 - 42,9	1440,0	2600,0	1
37037	3 G 70	38,4 - 48,3	2016,0	3400,0	2/0
37038	3 G 95	43,3 - 54,0	2736,0	4450,0	3/0
37039	3 G 120	47,4 - 60,0	3456,0	5180,0	4/0
37040	3 G 150	52,0 - 66,0	4320,0	6500,0	300 kcmil
37041	3 G 185	57,0 - 72,0	5328,0	7860,0	350 kcmil
37042	3 G 240	65,0 - 82,0	6912,0	10224,0	500 kcmil
37043	3 G 300	72,0 - 90,0	8640,0	12620,0	600 kcmil
37044	4 G 1	9,2 - 11,9	38,0	150,0	18
37045	4 G 1,5	10,2 - 13,1	58,0	200,0	16
37046	4 G 2,5	12,1 - 15,5	96,0	290,0	14
37047	4 G 4	14,0 - 17,9	154,0	395,0	12
37048	4 G 6	15,7 - 20,0	230,0	540,0	10
37049	4 G 10	20,9 - 26,5	384,0	950,0	8
37050	4 G 16	23,8 - 30,1	614,0	1260,0	6
37051	4 G 25	28,9 - 36,6	960,0	1860,0	4
37052	4 G 35	32,5 - 41,1	1344,0	2380,0	2
37053	4 G 50	37,7 - 47,5	1920,0	3190,0	1
37054	4 G 70	42,7 - 54,0	2688,0	4260,0	2/0

Part no.	No. cores x cross-sec. mm ²	Outer Ø min. - max. mm	Cop. weight kg / km	Weight app. kg / km	AWG-No.
37055	4 G 95	48,4 - 61,0	3648,0	5600,0	3/0
37056	4 G 120	53,0 - 66,0	4608,0	6830,0	4/0
37057	4 G 150	58,0 - 73,0	5760,0	8320,0	300 kcmil
37058	4 G 185	64,0 - 80,0	7104,0	9800,0	350 kcmil
37059	4 G 240	72,0 - 91,0	9216,0	12100,0	500 kcmil
37060	4 G 300	80,0 - 101,0	11520,0	15200,0	600 kcmil
37061	5 G 1,5	11,2 - 14,4	72,0	240,0	16
37062	5 G 2,5	13,3 - 17,0	120,0	345,0	14
37063	5 G 4	15,6 - 19,9	192,0	485,0	12
37064	5 G 6	17,5 - 22,2	288,0	650,0	10
37065	5 G 10	22,9 - 29,1	480,0	1200,0	8
37066	5 G 16	26,4 - 33,3	768,0	1550,0	6
37067	5 G 25	32,0 - 40,4	1200,0	2250,0	4
37068	5 G 35	35,7 - 45,1	1680,0	2750,0	2
37091	5 G 50	41,8 - 53,0	2400,0	3950,0	1
37154	5 G 70	47,5 - 60,0	3360,0	4740,0	2/0
34090	5 G 95	54,0 - 67,0	4560,0	6600,0	3/0
34349	5 G 120	58,0 - 73,0	5760,0	8180,0	4/0
34127	5 G 150	64,0 - 80,0	7200,0	10600,0	300 kcmil
37092	7 G 1,5	14,7 - 18,7	101,0	375,0	16
37079	7 G 2,5	17,1 - 21,8	168,0	520,0	14
37093	12 G 1,5	17,6 - 22,4	175,0	460,0	16
37096	12 G 2,5	20,6 - 26,2	288,0	760,0	14
37097	18 G 2,5	24,4 - 30,9	432,0	850,0	14
37094	19 G 1,5	20,7 - 26,3	274,0	810,0	16
37098	19 G 2,5	25,5 - 31,0	456,0	1075,0	14
37095	24 G 1,5	24,3 - 30,7	346,0	1015,0	16
37099	24 G 2,5	28,8 - 36,4	576,0	1390,0	14

Dimensions and specifications may be changed without prior notice. (RF01)

SOOW

rubber-sheathed cable



Technical data

- Rubber-sheathed cable acc. to UL Std.62
CAN/CSA-C 22.2 No.49
- UL - SOOW
CSA - SOOW
- **Temperature range**
-40°C to +90°C
- Permissible **operating temperature**
at the conductor +90°C
- **Nominal voltage**
600 V
- **Test voltage**
2500 V
- **Minimum bending radius**
flexing 6x cable Ø

Cable structure

- Copper-conductor bare or tinned, fine wire stranded with AWG dimensions
- Core insulation of rubber (EPR)
- Core identification
3 cores: BK, WH, GN
4 cores: BK, WH, RD, GN
5 cores: BK, WH, RD, GN, OG
- Cores stranded in layers with optimal lay length
- Separator
- Outer sheath of rubber (CPE)
- Sheath colour: black

Properties

- Ozone-resistant
- Weather and UV resistant
- Resistant to oils and greases

Application

Approved, heavy rubber-sheathed cable, for usage in dry, moist, wet rooms as well as outdoors. Used as supply cable in industrial plants and processing facilities, for cranes, hand lamps, lifting devices, construction machineries and motors.

☑ = Product conforms with Low-Voltage Directive 2014/35/EU.

Part no.	Cross-section mm ² x AWG-No.	No. cores	Outer Ø app. mm	Cop. weight kg / km	Weight app. kg / km	Part no.	Cross-section mm ² x AWG-No.	No. cores	Outer Ø app. mm	Cop. weight kg / km	Weight app. kg / km
38548	1	3 x 18	9,1	24,0	110,0	38557	4	3 x 12	15,2	95,0	323,0
38549	1	4 x 18	9,8	32,0	130,0	38558	4	4 x 12	16,5	127,0	389,0
38550	1	5 x 18	11,7	40,0	183,0	38559	4	5 x 12	17,8	159,0	475,0
38551	1,5	3 x 16	10,1	38,0	134,0	38560	6	3 x 10	16,5	152,0	419,0
38552	1,5	4 x 16	10,6	51,0	160,0	38561	6	4 x 10	18,0	202,0	500,0
38553	1,5	5 x 16	12,5	63,0	222,0	38562	6	5 x 10	19,3	253,0	609,0
38554	2,5	3 x 14	13,3	60,0	240,0	38563	10	3 x 8	21,1	241,0	673,0
38555	2,5	4 x 14	14,4	80,0	286,0	38564	10	4 x 8	23,5	322,0	859,0
38556	2,5	5 x 14	16,4	100,0	374,0	38565	10	5 x 8	25,4	402,0	1017,0

Dimensions and specifications may be changed without prior notice. (RF01)

HELUWIND® WK POWERLINE ALU MULTI

0,6/1 kV, finely stranded aluminium conductor



Technical data

- **Temperature range**
flexing -20°C to +90°C
fixed installation -40°C to +90°C
- **Nominal voltage**
0,6/1kV
- **Minimum bending radius**
flexing 8x cable Ø
fixed installation 6x cable Ø
- **Flame retardant**
EN 60332-1 Low Smoke Emission

Cable structure

- Aluminium conductor, finely stranded
- Special PVC insulation
- Other colours on request
- Core identification: colour code
- Special PVC compound sheath
On request: rubber insulated outer sheath
- Sheath colour: black

Properties

- Oil resistant
- UV resistant
- Flexible
- Lightweight
- Robust
- Durable
- Easy to assemble

Note

For more information, especially on custom cables and connectivity solutions, please contact us:
wind@helukabel.de

Application

The HELUWIND® WK POWERLINE ALU MULTI is a highly flexible aluminium cable with a fine wire stranded structure. Thanks to its high level of flexibility and reduced weight, this cable is suitable for many industrial applications.

The HELUWIND® WK POWERLINE ALU MULTI may only be used with certified connection technology from HELUKABEL®. This includes C8 crimp connections and screwed connections; both described in the "Connection Technology" section and tested in accordance with IEC 61238-1 cl. A.

The cable is also available in other insulation materials and in a halogen-free design.

= Product conforms with Low-Voltage Directive 2014/35/EU.

Part no.	No. cores x cross-sec. mm ²	Outer Ø app. mm	AL weight kg / km	Weight app. kg / km
711083	4x50	38,8	590,0	980,0
711084	4x70	43,0	824,0	1280,0
711085	4x95	50,0	1120,0	1640,0

Part no.	No. cores x cross-sec. mm ²	Outer Ø app. mm	AL weight kg / km	Weight app. kg / km
711086	4x120	54,5	1420,0	2005,0
711087	4x150	58,0	1764,0	2320,0

Dimensions and specifications may be changed without prior notice.

HELUTHERM® 145 MULTI

flexible, cross-linked, halogen-free, meter marking



Technical data

- Halogen-free control and connecting cable with increased heat resistance
- **Temperature range**
flexing -35°C to +120°C
fixed installation -55°C to +145°C
in short-circuit +250°C
- **Nominal voltage**
up to 1,0 mm² U₀/U 300/500 V
from 1,5 mm² U₀/U 450/750 V
with protected fixed installation
from 1,5 mm² U₀/U 600/1000 V
- **Test voltage**
3000 V
- **Minimum bending radius**
in operation 8x cable Ø
fixed installation 4x cable Ø
- **Caloric load values**
see "Technical Informations"
- **Power ratings table**
see "Technical Informations"
- **Approval**
Germanischer Lloyd

Cable structure

- Tinned Cu wires, acc. to
DIN VDE 0295 cl.5, BS 6360 cl.5
and IEC 60228 cl. 5
- Core insulation of halogen-free,
cross-linked polyolefin-copolymer
- Core identification to DIN VDE 0293-308
- for 2 cores BN, BU
- up to 5 cores coloured
- from 6 cores, black with continuous
white numbering
- GN-YE conductor, 3 cores and above
- Cores stranded in layers with
optimal lay length
- Fleece wrapping
- Outer sheath of halogen-free,
cross-linked Polyolefin-Copolymer
- Sheath colour: black
- With meter marking

Note

- G = with GN-YE conductor
x = without GN-YE conductor
- Also available in other colours on request
- AWG sizes are approximate equivalent
values. The actual cross section is in mm².
- Screened analogue type:

HELUTHERM® 145 MULTI-C

Properties

- Reduced flame propagation
- Good abrasion and notch resistance
- Good resistance to oils and weathering
- Resistant to UV radiation and ozone
- Resistant to soldering temperatures
- Thermal class B
- Are resistant to melting, even when in
contact with a soldering iron at
temperatures of between 300°C and
380°C, because of the cross-linking for
the insulation material
- The materials used during manufacturing
are cadmium-free, contain no silicone
and are free from substances harmful
to the wetting properties of lacquers

Tests

- Flame test (unit flame test) acc. to
DIN VDE 0482-332-3-22, BS 4066 part 3,
DIN EN 60332-3-22, IEC 60332-3-22
(previously DIN VDE 0472
part 804 test method C)
- Flame test (cable) acc. to
DIN VDE 0482-332-1-2, DIN EN 60332-1-2,
IEC 60332-1-2 (equivalent DIN VDE 0472
part 804 test method B)
- Corrosiveness of combustion gases
acc. to DIN VDE 0482 part 267,
DIN EN 50267-2-2, IEC 60754-2
(equivalent DIN VDE 0472 part 813)
- Halogen-free
acc. to DIN VDE 0482 part 267,
DIN EN 50267-2-1, IEC 60754-1
(equivalent DIN VDE 0472 part 815)
- Smoke density
acc. to DIN VDE 0482 part 1034-1+2,
DIN EN 61034-1+2, IEC 61034-1+2,
BS 7622 part 1+2
(previously DIN VDE 0472 part 816)

Application

These halogen-free, cross-linked and temperature resistant wiring and control cables with enhanced fire-behaviour properties are used for wiring up the lighting fixtures, heaters, electric machines (temperature class B), switching systems and distribution switchboards. A very long service life is also given on account of their excellent high-temperature stability. These cables exhibit good resistance to weathering as well as being very stable to temperature, moisture, ozone and UV radiation. These cables are therefore mainly used for traffic control systems and diverse outdoor applications. The development of smoke is low and no corrosive gases are liberated during combustion of these halogen-free cables in case of fire. The risk of toxic fumes is considerably less in the event of fire because the caloric load values is lower. Precious time can thus be won for a disciplined evacuation, and unnecessary loss of life can be prevented. The extent of the damage to costly control and monitoring systems and the concrete and steel structures of buildings and plant due to fire is reduced by this. Injuries to persons and damage to materials can be prevented. A lower conductor cross section is possible in certain circumstances because of the high thermal load and thus savings in the space and weight required can be made. These wiring and control cables provide a significant contribution in safety engineering and environmental protection.

CE = Product conforms with Low-Voltage Directive 2014/35/EU.

Part no.	No. cores x cross-sec. mm ²	Outer Ø app. mm	Cop. weight kg / km	Weight app. kg / km	AWG-No.	Part no.	No. cores x cross-sec. mm ²	Outer Ø app. mm	Cop. weight kg / km	Weight app. kg / km	AWG-No.
53376	1 x 0,25	2,9	2,4	11,4	24	53381	6 G 0,25	6,5	14,4	58,0	24
52630	1 G 0,25	2,9	2,4	11,4	24	53382	7 G 0,25	6,9	16,8	64,0	24
53377	2 x 0,25	4,6	4,8	28,7	24	53383	8 G 0,25	7,3	19,2	71,0	24
53378	3 G 0,25	4,9	7,2	33,7	24	53384	10 G 0,25	8,1	24,0	84,0	24
53379	4 G 0,25	5,5	9,6	41,8	24	53385	12 G 0,25	8,1	28,8	90,0	24
53380	5 G 0,25	5,8	12,0	47,0	24	53386	14 G 0,25	8,6	33,6	102,0	24

Continuation ▶

HELUTHERM® 145 MULTI

flexible, cross-linked, halogen-free, meter marking



Part no.	No. cores x cross-sec. mm ²	Outer Ø app. mm	Cop. weight kg / km	Weight app. kg / km	AWG-No.
53387	16 G 0,25	8,9	38,4	114,0	24
53388	19 G 0,25	10,1	45,6	132,0	24
53389	21 G 0,25	10,5	50,4	145,0	24
52631	1 G 0,5	3,2	4,8	15,7	20
53391	1 x 0,5	3,2	4,8	15,7	20
53392	2 x 0,5	5,1	9,6	39,6	20
53393	3 G 0,5	5,5	14,4	48,1	20
53394	4 G 0,5	5,9	19,2	51,0	20
53395	5 G 0,5	6,7	24,0	64,0	20
53396	6 G 0,5	7,1	28,8	74,0	20
53397	7 G 0,5	7,8	33,6	88,0	20
53398	8 G 0,5	8,6	38,4	102,0	20
53399	10 G 0,5	9,4	48,0	123,0	20
53400	12 G 0,5	9,4	57,6	135,0	20
53401	14 G 0,5	10,0	67,2	153,0	20
53402	16 G 0,5	10,7	76,8	176,0	20
53403	19 G 0,5	12,4	91,2	213,0	20
53404	21 G 0,5	13,0	100,8	234,0	20
53405	24 G 0,5	14,0	115,2	263,0	20
53406	25 G 0,5	14,0	120,0	269,0	20
53407	27 G 0,5	14,0	129,6	280,0	20
53408	30 G 0,5	15,0	144,0	311,0	20
53409	33 G 0,5	15,0	158,4	343,0	20
53410	37 G 0,5	17,0	177,6	392,0	20
52632	1 G 0,75	3,5	7,2	19,8	19
53411	1 x 0,75	3,5	7,2	19,8	19
53412	2 x 0,75	5,9	14,4	40,0	19
53413	3 G 0,75	6,2	21,6	53,0	19
53414	4 G 0,75	6,9	28,8	69,0	19
53415	5 G 0,75	7,7	36,0	86,0	19
53416	6 G 0,75	8,3	43,2	101,0	19
53417	7 G 0,75	9,1	50,4	117,0	19
53418	8 G 0,75	10,2	57,6	140,0	19
53419	10 G 0,75	11,1	72,0	167,0	19
53420	12 G 0,75	11,1	86,4	183,0	19
53421	14 G 0,75	11,7	100,8	212,0	19
53422	16 G 0,75	12,5	115,2	239,0	19
53423	19 G 0,75	14,0	136,8	290,0	19
53424	21 G 0,75	15,0	151,2	323,0	19
53425	24 G 0,75	16,0	172,8	364,0	19
53426	25 G 0,75	16,0	180,0	371,0	19
53427	27 G 0,75	16,0	194,4	387,0	19
53428	30 G 0,75	17,0	216,0	429,0	19
53429	33 G 0,75	18,0	237,6	468,0	19
53430	37 G 0,75	19,0	266,4	550,0	19
52633	1 G 1	3,9	9,6	25,2	18
53431	1 x 1	3,9	9,6	25,2	18
53432	2 x 1	6,3	19,2	50,0	18
53433	3 G 1	6,8	28,8	66,0	18
53434	4 G 1	7,4	38,4	86,0	18
53435	5 G 1	8,3	48,0	106,0	18
53436	6 G 1	8,9	57,6	127,0	18
53437	7 G 1	9,9	67,2	155,0	18
53438	8 G 1	11,0	76,8	187,0	18
53439	10 G 1	12,1	96,0	214,0	18
53440	12 G 1	12,1	115,2	230,0	18
53441	14 G 1	12,7	134,4	266,0	18
53442	16 G 1	13,6	153,6	301,0	18
53443	19 G 1	15,1	182,4	377,0	18
53444	21 G 1	16,0	201,6	419,0	18
53445	24 G 1	17,1	230,4	464,0	18
53446	25 G 1	17,1	240,0	472,0	18
53447	27 G 1	17,1	259,2	488,0	18
53448	30 G 1	17,7	288,0	536,0	18
53449	33 G 1	18,9	316,8	605,0	18
53450	37 G 1	20,3	355,2	690,0	18
52634	1 G 1,5	4,3	14,4	32,3	16
53451	1 x 1,5	4,3	14,4	32,3	16
53452	2 x 1,5	7,6	28,8	69,0	16
53453	3 G 1,5	8,1	43,2	93,0	16
53454	4 G 1,5	8,8	57,6	120,0	16
53455	5 G 1,5	9,8	72,0	152,0	16
53456	6 G 1,5	10,9	86,4	187,0	16
53457	7 G 1,5	12,0	100,8	222,0	16
53458	8 G 1,5	14,0	115,2	263,0	16
53459	10 G 1,5	14,6	144,0	308,0	16
53460	12 G 1,5	14,6	172,8	330,0	16
53461	14 G 1,5	15,4	201,6	383,0	16
53462	16 G 1,5	16,2	230,4	438,0	16
53463	19 G 1,5	18,3	273,6	554,0	16
53464	21 G 1,5	19,7	302,4	614,0	16
53465	24 G 1,5	21,1	345,6	791,0	16
53466	25 G 1,5	21,1	360,0	701,0	16
53467	27 G 1,5	21,1	388,8	723,0	16
53468	30 G 1,5	21,8	432,0	796,0	16
53469	33 G 1,5	22,6	475,2	880,0	16
53470	37 G 1,5	24,8	532,8	1026,0	16
52635	1 G 2,5	5,0	24,0	46,9	14

Part no.	No. cores x cross-sec. mm ²	Outer Ø app. mm	Cop. weight kg / km	Weight app. kg / km	AWG-No.
53471	1 x 2,5	5,0	24,0	46,9	14
53472	2 x 2,5	9,0	48,0	99,0	14
53473	3 G 2,5	9,8	72,0	140,0	14
53474	4 G 2,5	10,8	96,0	183,0	14
53475	5 G 2,5	12,0	120,0	231,0	14
53476	6 G 2,5	13,2	144,0	280,0	14
53477	7 G 2,5	14,6	168,0	336,0	14
53478	8 G 2,5	15,7	192,0	397,0	14
53479	10 G 2,5	17,7	240,0	460,0	14
53480	12 G 2,5	18,7	288,0	500,0	14
53481	14 G 2,5	19,0	336,0	593,0	14
53482	16 G 2,5	20,1	384,0	675,0	14
53483	19 G 2,5	20,7	456,0	835,0	14
53484	21 G 2,5	23,7	504,0	939,0	14
53485	24 G 2,5	25,8	576,0	1047,0	14
53486	25 G 2,5	25,8	600,0	1067,0	14
53487	27 G 2,5	25,8	648,0	1107,0	14
53488	30 G 2,5	26,7	720,0	1219,0	14
53489	33 G 2,5	28,0	792,0	1349,0	14
53490	37 G 2,5	30,6	888,0	1565,0	14
52636	1 G 4	5,6	38,4	96,0	12
53491	1 x 4	5,6	38,4	96,0	12
53492	2 x 4	10,2	76,8	159,0	12
53493	3 G 4	10,9	115,2	197,0	12
53494	4 G 4	12,2	153,6	260,0	12
53495	5 G 4	13,5	192,0	329,0	12
53496	6 G 4	14,9	230,4	398,0	12
53497	7 G 4	16,4	268,8	478,0	12
53498	8 G 4	17,6	307,2	553,0	12
53499	10 G 4	20,1	384,0	663,0	12
53500	12 G 4	20,1	460,8	725,0	12
53501	14 G 4	21,5	537,6	797,0	12
52637	1 G 6	6,1	57,6	108,0	10
53502	1 x 6	6,1	57,6	108,0	10
53503	2 x 6	11,6	115,2	216,0	10
53504	3 G 6	12,4	172,8	285,0	10
53505	4 G 6	13,8	230,4	375,0	10
53506	5 G 6	15,4	288,0	465,0	10
53507	6 G 6	16,7	345,6	544,0	10
53508	7 G 6	18,3	403,2	664,0	10
52638	1 G 10	7,7	96,0	144,0	8
53509	1 x 10	7,7	96,0	144,0	8
53510	2 x 10	14,7	192,0	351,0	8
53511	3 G 10	15,7	288,0	475,0	8
53512	4 G 10	17,5	384,0	630,0	8
53513	5 G 10	19,6	480,0	782,0	8
53514	6 G 10	21,7	576,0	914,0	8
53515	7 G 10	23,7	672,0	1092,0	8
52639	1 G 16	9,1	153,6	205,0	6
53516	1 x 16	9,1	153,6	205,0	6
53517	2 x 16	17,7	307,2	495,0	6
53518	3 G 16	19,3	460,8	691,0	6
53519	4 G 16	21,5	614,4	905,0	6
53520	5 G 16	23,9	768,0	1129,0	6
53521	6 G 16	26,2	921,6	1327,0	6
53522	7 G 16	28,9	1075,2	1590,0	6
52640	1 G 25	10,0	240,0	336,0	4
53523	1 x 25	10,9	240,0	336,0	4
53524	2 x 25	21,3	480,0	833,0	4
53525	3 G 25	22,7	720,0	1139,0	4
53526	4 G 25	25,4	960,0	1489,0	4
53527	5 G 25	28,1	1200,0	1863,0	4
53528	6 G 25	31,1	1440,0	2275,0	4
53529	7 G 25	34,5	1680,0	2633,0	4
52641	1 G 35	12,1	336,0	454,0	2
53530	1 x 35	12,1	336,0	454,0	2
53531	2 x 35	23,7	672,0	1104,0	2
53532	3 G 35	25,5	1008,0	1513,0	2
53533	4 G 35	28,4	1344,0	1992,0	2
53534	5 G 35	31,3	1680,0	2488,0	2
52642	1 G 50	14,9	480,0	638,0	1
53535	1 x 50	14,9	480,0	638,0	1
53536	2 x 50	29,3	960,0	1573,0	1
53537	3 G 50	31,5	1440,0	2154,0	1
53538	4 G 50	35,3	1920,0	2819,0	1
53539	5 G 50	39,1	2400,0	3505,0	1
52643	1 G 70	17,1	672,0	875,0	2/0
53540	1 x 70	17,1	672,0	875,0	2/0
53541	2 x 70	33,7	1344,0	2157,0	2/0
53542	3 G 70	36,4	2016,0	2946,0	2/0
53543	4 G 70	40,3	2688,0	3888,0	2/0
53544	5 G 70	44,5	3360,0	4864,0	2/0
52644	1 G 95	19,2	912,0	1149,0	3/0
53545	1 x 95	19,2	912,0	1149,0	3/0
53546	2 x 95	37,5	1824,0	2763,0	3/0
53547	3 G 95	40,0	2736,0	3835,0	3/0
53548	4 G 95	45,3	3648,0	5052,0	3/0
53549	5 G 95	50,7	4560,0	6307,0	3/0

Dimensions and specifications may be changed without prior notice. (RE01)

HELUTHERM® 145 MULTI-C

flexible, cross-linked, halogen-free, Cu-screened, EMC-preferred type



Technical data

- Temperature-resistant and halogen-free connection and control cable
- **Temperature range**
flexing -35°C to +120°C
fixed installation -55°C to +145°C
in short-circuit +250°C
- **Nominal voltage**
up to 1,0 mm² U₀/U 300/500 V
from 1,5 mm² U₀/U 450/750 V
with protected fixed installation
from 1,5 mm² U₀/U 600/1000 V
- **Test voltage**
3000 V
- **Minimum bending radius**
in operation 8x cable Ø
fixed installation 4x cable Ø
- **Coupling resistance**
max. 250 Ohm/km
- **Caloric load values**
see "Technical Informations"
- **Power ratings table**
see "Technical Informations"
- **Approval**
Germanischer Lloyd

Cable structure

- Tinned copper conductor, to DIN VDE 0295 cl.5, fine wire, BS 6360 cl.5, IEC 60228 cl.5
- Core insulation of cross-linked, halogen-free polyolefin-copolymer
- Core identification black cores with continuous white numbering
- Cores stranded in layers with optimal lay length
- Tinned copper braided screen, approx. 85% coverage
- Outer sheath of cross-linked, halogen-free polyolefin-copolymer
- Sheath colour: black
- With meter marking

Note

- Also available in other colours on request
- AWG sizes are approximate equivalent values. The actual cross section is in mm².
- Unscreened analogue type:
HELUTHERM® 145 MULTI

Properties

- Lower propagation of fire
- Low development of smoke and fumes
- Good abrasion and notch resistance
- Good resistance to oils and weathering
- Resistant to UV radiation and ozone
- Resistant to soldering temperatures
- Thermal class B
- These control cables are resistant to melting, even when in contact with a soldering iron at temperatures of between 300°C and 380°C, because of the cross-linking for the insulation material
- The materials used during manufacturing are cadmium-free, contain no silicone and are free from substances harmful to the wetting properties of lacquers

Tests

- Flame test (unit flame test) acc. to DIN VDE 0482-332-3-22, BS 4066 Teil 3, DIN EN 60332-3-22, IEC 60332-3-22 (previously DIN VDE 0472 part 804 test method C)
- Flame test (cable) acc. to DIN VDE 0482-332-1-2, DIN EN 60332-1-2, IEC 60332-1-2 (equivalent DIN VDE 0472 part 804 test method B)
- Corrosiveness of combustion gases acc. to DIN VDE 0482 part 267, DIN EN 50267-2-2, IEC 60754-2 (equivalent DIN VDE 0472 part 813)
- Halogen-free acc. to DIN VDE 0482 part 267, DIN EN 50267-2-1, IEC 60754-1 (equivalent DIN VDE 0472 part 815)
- Smoke density acc. to DIN VDE 0482 part 1034-1+2, DIN EN 61034-1+2, IEC 61034-1+2, BS 7622 part 1+2 (previously DIN VDE 0472 part 816)

Application

These halogen-free, cross-linked and temperature resistant wiring and control cables with enhanced fire-behaviour properties are used for wiring up the lighting fixtures, heaters, electric machines (temperature class B), switching systems and distribution switchboards. A very long service life is also given on account of their excellent high-temperature stability. These cables exhibit good resistance to weathering as well as being very stable to temperature, moisture, ozone and UV radiation. These cables are therefore mainly used for traffic control systems and diverse outdoor applications. The development of smoke is low and no corrosive gases are liberated during combustion of these halogen-free cables in case of fire. The risk of toxic fumes is considerably less in the event of fire because the caloric load values is lower. Precious time can thus be won for a disciplined evacuation, and unnecessary loss of life can be prevented. The extent of the damage to costly control and monitoring systems and the concrete and steel structures of buildings and plant due to fire is reduced by this. Injuries to persons and damage to materials can be prevented. A lower conductor cross section is possible in certain circumstances because of the high thermal load and thus savings in the space and weight required can be made. These wiring and control cables provide a significant contribution in safety engineering and environmental protection.

EMC = Electromagnetic compatibility

To optimize the EMC features we recommend a large round contact of the copper braiding on both ends.

CE = Product conforms with Low-Voltage Directive 2014/35/EU.

Part no.	No. cores x cross-sec. mm ²	Outer Ø app. mm	Cop. weight kg / km	Weight app. kg / km	AWG-No.
52194	2 x 0,25	5,0	16,0	36,0	24
52195	3 x 0,25	5,5	21,0	44,0	24

Part no.	No. cores x cross-sec. mm ²	Outer Ø app. mm	Cop. weight kg / km	Weight app. kg / km	AWG-No.
52196	5 x 0,25	6,4	29,0	68,0	24
52197	7 x 0,25	7,5	37,0	95,0	24

Continuation ▶

HELUTHERM® 145 MULTI-C

flexible, cross-linked, halogen-free, Cu-screened, EMC-preferred type



Part no.	No. cores x cross-sec. mm ²	Outer Ø app. mm	Cop. weight kg / km	Weight app. kg / km	AWG-No.	Part no.	No. cores x cross-sec. mm ²	Outer Ø app. mm	Cop. weight kg / km	Weight app. kg / km	AWG-No.
52198	1 x 0,5	3,7	15,0	24,0	20	52246	7 x 1,5	12,6	136,0	264,0	16
52199	2 x 0,5	5,6	29,0	55,0	20	52247	8 x 1,5	13,7	172,0	308,0	16
52200	3 x 0,5	6,1	38,0	64,0	20	52248	10 x 1,5	15,0	193,0	361,0	16
52201	4 x 0,5	6,7	45,0	78,0	20	52249	12 x 1,5	15,0	222,0	383,0	16
52202	5 x 0,5	7,3	51,0	95,0	20	52250	14 x 1,5	16,0	272,0	458,0	16
52203	6 x 0,5	7,9	66,0	106,0	20	52251	16 x 1,5	17,0	285,0	515,0	16
52204	7 x 0,5	8,4	68,0	122,0	20	52252	19 x 1,5	19,3	331,0	639,0	16
52205	8 x 0,5	9,0	80,0	138,0	20	52253	21 x 1,5	20,3	367,0	705,0	16
52206	10 x 0,5	10,0	93,0	161,0	20	51000	25 x 1,5	21,7	526,0	841,0	16
52207	12 x 0,5	10,0	107,0	170,0	20	52254	1 x 2,5	5,6	28,0	59,0	14
52208	14 x 0,5	11,0	122,0	193,0	20	52255	2 x 2,5	9,8	96,0	148,0	14
52209	16 x 0,5	11,7	129,0	216,0	20	52256	3 x 2,5	10,4	146,0	183,0	14
52210	19 x 0,5	12,8	158,0	253,0	20	52257	4 x 2,5	11,5	150,0	221,0	14
52211	21 x 0,5	13,5	167,0	281,0	20	52258	5 x 2,5	12,6	200,0	273,0	14
52212	1 x 0,75	4,0	18,0	29,0	19	52259	6 x 2,5	13,8	227,0	326,0	14
52213	2 x 0,75	6,6	38,0	71,0	19	52260	7 x 2,5	15,3	235,0	397,0	14
52214	3 x 0,75	6,9	50,0	82,0	19	52261	8 x 2,5	16,5	265,0	475,0	14
52215	4 x 0,75	7,6	58,0	100,0	19	52262	10 x 2,5	18,3	326,0	542,0	14
52216	5 x 0,75	8,3	70,0	117,0	19	52263	12 x 2,5	18,3	376,0	582,0	14
52217	6 x 0,75	8,9	85,0	135,0	18	52264	14 x 2,5	19,6	428,0	681,0	14
52218	7 x 0,75	9,9	90,0	158,0	19	52265	16 x 2,5	20,7	480,0	778,0	14
52219	8 x 0,75	10,6	110,0	178,0	19	52266	19 x 2,5	23,5	557,0	948,0	14
52220	10 x 0,75	11,5	140,0	207,0	19	52267	21 x 2,5	24,4	606,0	1042,0	14
52221	12 x 0,75	11,5	148,0	220,0	19	52268	1 x 4	6,3	56,0	86,0	12
52222	14 x 0,75	12,2	167,0	250,0	19	52269	2 x 4	10,9	135,0	196,0	12
52223	16 x 0,75	12,9	183,0	282,0	19	52270	3 x 4	11,5	178,0	248,0	12
52224	19 x 0,75	14,5	212,0	335,0	19	52271	4 x 4	12,8	220,0	316,0	12
52225	21 x 0,75	15,3	230,0	370,0	19	52272	5 x 4	14,3	259,0	376,0	12
52226	1 x 1	4,2	20,0	33,0	18	52273	6 x 4	15,6	302,0	452,0	12
52227	2 x 1	7,0	46,0	78,0	18	52274	7 x 4	17,0	355,0	555,0	12
52228	3 x 1	7,4	56,0	92,0	18	52275	8 x 4	18,3	392,0	655,0	12
52229	4 x 1	8,1	66,0	112,0	18	52276	10 x 4	20,7	480,0	767,0	12
52230	5 x 1	8,9	95,0	134,0	18	52277	12 x 4	20,7	557,0	829,0	12
52231	6 x 1	9,5	105,0	164,0	18	52278	14 x 4	22,1	636,0	948,0	12
52232	7 x 1	10,5	109,0	192,0	18	52279	1 x 6	6,9	81,0	108,0	10
52233	8 x 1	11,4	130,0	219,0	18	52280	2 x 6	12,1	175,0	255,0	10
52234	10 x 1	12,5	138,0	254,0	18	52281	3 x 6	12,8	240,0	330,0	10
52235	12 x 1	12,5	164,0	270,0	18	52282	4 x 6	14,3	305,0	429,0	10
52236	14 x 1	13,5	198,0	308,0	18	52283	5 x 6	16,0	441,0	536,0	10
52237	16 x 1	14,3	203,0	350,0	18	52284	6 x 6	17,4	473,0	624,0	10
52238	19 x 1	16,2	235,0	447,0	18	52285	7 x 6	19,3	505,0	751,0	10
52239	21 x 1	17,0	257,0	492,0	18	52286	1 x 10	8,4	124,0	170,0	8
52240	1 x 1,5	4,8	22,0	42,0	16	52287	2 x 10	15,1	265,0	409,0	8
52241	2 x 1,5	8,2	58,0	105,0	16	52288	3 x 10	16,4	370,0	550,0	8
52242	3 x 1,5	8,7	71,0	121,0	16	52289	4 x 10	18,1	485,0	715,0	8
52243	4 x 1,5	9,4	86,0	156,0	16	52290	5 x 10	20,2	610,0	882,0	8
52244	5 x 1,5	10,5	104,0	188,0	16	52291	6 x 10	22,3	715,0	1026,0	8
52245	6 x 1,5	11,5	118,0	225,0	16	52292	7 x 10	24,3	820,0	1195,0	8

Dimensions and specifications may be changed without prior notice. (RE01)





H07 V-K / (H)07 V-K

FIVENORM

THHN/THWN

H05Z-K/H07z-K

■ SINGLE CONDUCTORS

Designation	Page
HEL UWIND® WK POWERLINE ALU Single	156
H07V-K / (H)07V-K	157
H05Z-K / H07Z-K	159
FIVENORM	161
HELUTHERM® 145	164
HELUTHERM® 145, 600V	166
THHN/THWN	167

HELUWIND® WK POWERLINE ALU SINGLE

0,6/1 kV, flexible aluminium stranded wires



Technical data

- **Temperature range**
flexing -20°C to +90°C
fixed installation -40°C to +105°C
- Permissible conductor **operating temperature** +105°C up to 3000h
- **Nominal voltage**
0,6/1 kV
- **Test voltage**
2,5 kV
- **Minimum bending radius**
4x cable Ø acc. to
DIN VDE 0298 Part 3, Table 2
- **Flame test**
IEC 60332-1-2
- **Approvals**
conforms to DIN VDE 0250-813
UL/CSA in preparation

Cable structure

- Fine-wire aluminium strands
- Special insulation black
- Other colours available upon request

Properties

- UV resistant
- Oil resistant
- Easy to assemble
- Recyclable

Note

For more information, especially on custom cables and connectivity solutions, please contact us: wind@helukabel.de

Application

The HELUWIND® WK POWERLINE ALU Single is a highly flexible, fine-wire, single conductor with a heat-resistant wire insulation. Its reduced weight of up to 50% over comparable copper wires (H07-VK) provides a huge advantage in many applications.

The HELUWIND® WK POWERLINE ALU Single may only be used with certified connection technology from HELUKABEL®. This includes C8 crimp connections and screwed connections; both described in the "Connection Technology" section and tested in accordance with IEC 61238-1 cl. A. A space-saving welding technique is available as an additional option.

The wire is also available in a halogen-free design, with UL/CSA approval, and a rated voltage of 1.8/3 kV. Suitable for the interior wiring of devices, distributors, and switchboards as well as for protected laying in and on lamps with a nominal voltage up to 1000 V AC or up to 750 V DC towards the end. Not suitable for direct laying on trays, gutters, or tubs.

☑️ = Product conforms with Low-Voltage Directive 2014/35/EU.

Part no.	No. cores x cross-sec. mm ²	AWG-No.	Outer Ø app. mm	AL weight kg / km	Weight app. kg / km
709914	1x70	-	15,9	206,0	315,0
709915	1x95	-	17,2	280,0	420,0
709916	1x120	-	18,2	355,0	507,0
709917	1x150	-	19,2	441,0	601,0

Part no.	No. cores x cross-sec. mm ²	AWG-No.	Outer Ø app. mm	AL weight kg / km	Weight app. kg / km
709918	1x185	-	22,1	544,0	950,0
709919	1x240	-	25,1	706,0	1060,0
709920	1x300	-	27,8	882,0	1290,0
709921	1x400	-	32,7	1176,0	1460,0

Dimensions and specifications may be changed without prior notice.

H07V-K / (H)07V-K

PVC-Single Cores, fine wire stranded



Technical data

- PVC single cores to
DIN VDE 0285-525-2-31/
DIN EN 50525-2-31 and IEC 60227-3
- **Temperature range**
flexing -5°C to +70°C
fixed installation -30°C to +80°C
- **Nominal voltage**
U₀/U 450/750 V
- **Test voltage**
2500 V
- **Insulation resistance**
min. 10 MOhm x km
- **Minimum bending radius**
fixed installation
core Ø ≤ 8 mm: 4x core Ø
core Ø > 8-12 mm: 5x core Ø
core Ø > 12 mm: 6x core Ø
- **Radiation resistance**
up to 80x10⁶ cJ/kg (up to 80 Mrad)

Cable structure

- Bare Cu-conductor, to
DIN VDE 0295 cl.5, fine wire,
BS 6360 cl.5, IEC 60228 cl.5
- Core insulation of PVC
compound type T11 to
DIN VDE 0207-363-3 / DIN EN 50363-3
and IEC 60227-3
- Core identification: see table below

Properties

- The materials used during manufacturing
are cadmium-free, contain no silicone
and are free from substances harmful
to the wetting properties of lacquers

Tests

- PVC self-extinguishing and flame retardant
acc. to DIN VDE 0482-332-1-2,
DIN EN 60332-1-2, IEC 60332-1-2
(equivalent DIN VDE 0472 part 804
test method B)

Note

- The following colours are recommended
(only single colour): black, white, blue, grey,
brown, red, orange, turquoise, violet and
pink. Two-coloured combinations are not
allowed, with exceptions of green-yellow.
- Colours yellow, green, transparent only in
(H)07V-K available.
- Two-coloured combination is only
permitted for (H)07V-K.

Application

These single cores are suitable for laying in tubes, under and surface mounting of plasters and also in closed installation conduits. These are not allowed to install for direct laying on cable trays, channels or tanks. These types are permitted for the inner wiring of equipment, distributor and switchboards and also for protective laying to the lightings with a nominal voltage up to 1000 V alternating current or up to 750 V direct current against earth.

☑ = Product conforms with Low-Voltage Directive 2014/35/EU.

H07V-K, (H)07V-K

Cross-sec. mm ² app. RAL	Outer Ø min. - max. mm	Cop. weight kg / km	BK	GN-YE	BU	BN	RD	WH	GY	VT	YE	PK	GN	TRANS	D-BU	OG	2-col.	U-BU
			9005	-	5015	8003	3000	9003	7001	4005	1021	3015	6018	-	5010	2003	-	5002



Coil in cardboard (100m)

Packing

H07V-K coil

Part no.	Outer Ø min. - max. mm	Cop. weight kg / km	29129	29130	29131	29132	29133	29134	29135	29136	29137	29138	29139	29140	29141	29142	29144	26395
1,5	2,8 - 3,4	14,4																
2,5	3,4 - 4,1	24,0	29145	29146	29147	29148	29149	29150	29151	29152	29153	29154	29155	29156	29157	29158	29160	26396
4	3,9 - 4,8	38,0	29161	29162	29163	29164	29165	29166	29167	29168	29169	29170	29171	29172	29173	29174	29176	26397
6	4,4 - 5,3	58,0	29177	29178	29179	29180	29181	29182	29183	29184	29185	29186	29187	29188	29189	29190	29192	26398



Spool (with various capacity)

Packing

H07V-K spool

Part no.	Outer Ø min. - max. mm	Cop. weight kg / km	26690	26691	26692	26693	26694	26695	26696	26697	26698	26699	26700	26701	26702	26703	26705	26399
1,5	2,8 - 3,4	14,4																
2,5	3,4 - 4,1	24,0	26706	26707	26708	26709	26710	26711	26712	26713	26714	26715	26716	26717	26718	26719	26721	26400
4	3,9 - 4,8	38,0	26722	26723	26724	26725	26726	26727	26728	26729	26730	26731	26732	26733	26734	26735	26737	26401
6	4,4 - 5,3	58,0	26738	26739	26740	26741	26742	26743	26744	26745	26746	26747	26748	26749	26750	26751	26753	26402

Continuation ▶

H07V-K / (H)07V-K

PVC-Single Cores, fine wire stranded

H05V-U, (H)05V-U, (H)07V-U



Cross-sec. mm²	Outer Ø min. - max. mm	Cop. weight kg / km	BK	GN-YE	BU	BN	RD	WH	GY	VT	YE	PK	GN	TRANS	D-BU	OG	2-col.	U-BU
app. RAL			9005	-	5015	8003	3000	9003	7001	4005	1021	3015	6018	-	5010	2003	-	5002



Packing **Barrel (with various capacity)**

H07V-K barrel

Part no.			26755	26756	26757	26758	26759	26760	26761	26762	26763	26764	26765	26766	26767	26768	26770	26403
1,5	2,8 - 3,4	14,4																
Part no.			26771	26772	26773	26774	26775	26776	26777	26778	26779	26780	26781	26782	26783	26784	26786	26404
2,5	3,4 - 4,1	24,0																
Part no.			26787	26788	26789	26790	26791	26792	26793	26794	26795	26796	26797	26798	26799	26800	26802	26819
4	3,9 - 4,8	38,0																
Part no.			26803	26804	26805	26806	26807	26808	26809	26810	26811	26812	26813	26814	26815	26816	26818	26820
6	4,4 - 5,3	58,0																



Packing **Coil in foil (100m)**

H07V-K coil

Part no.			26060	26061	26062	26063	26064	26065	26066	26067	26068	26069	26092	26099	26108	26109	26111	26821
1,5	2,8 - 3,4	14,4																
Part no.			26112	26113	26114	26115	26116	26117	26118	26119	29855	29856	29857	29858	29859	29890	29892	26822
2,5	3,4 - 4,1	24,0																
Part no.			29893	29894	29895	29896	29897	29898	29899	29905	29906	29907	29908	29909	29910	29911	29913	26823
4	3,9 - 4,8	38,0																
Part no.			29914	29915	29916	29917	29918	29919	29921	29922	29923	29924	29925	29926	29927	29928	29933	26824
6	4,4 - 5,3	58,0																
Part no.			29193	29194	29195	29196	29197	29198	29199	29200	29201	29202	29203	29204	29205	29206	29208	-
10	5,7 - 6,8	96,0																
Part no.			29209	29210	29211	29212	29213	29214	29215	29216	29217	29218	29219	29220	29221	29222	29224	-
16	6,7 - 8,1	154,0																
Part no.			29225	29226	29227	29228	29229	29230	29231	29232	29233	29234	29235	29236	29237	29238	29240	-
25	8,4 - 10,2	240,0																
Part no.			29241	29242	29243	29244	29245	29246	29247	29248	29249	29250	29251	29252	29253	29254	29256	-
35	9,7 - 11,7	336,0																
Part no.			29257	29258	29259	29260	29261	29262	29263	29264	29265	29266	29267	29268	29269	29270	29272	-
50	11,5 - 13,9	480,0																
Part no.			29273	29274	29275	29276	29277	29278	29279	29280	29281	29282	29283	29284	29285	29286	29288	-
70	13,2 - 16,0	672,0																
Part no.			29289	29290	29291	29292	29293	29294	29295	29296	29297	29298	29299	29300	29301	29302	29304	-
95	15,1 - 18,2	912,0																
Part no.			29418	29419	29420	29421	29422	29423	29424	29425	29426	29427	29428	29429	29430	29431	29433	-
120	16,7 - 20,2	1152,0																
Part no.			29434	29435	29436	29437	29438	29439	29440	29441	29442	29443	29444	29445	29446	29447	29449	-
150	18,6 - 22,5	1440,0																
Part no.			29494	29495	29496	29497	29498	29499	29590	29591	29592	29593	29594	29595	29596	29597	29599	-
185	20,6 - 24,9	1776,0																
Part no.			29813	29814	29815	29816	29817	29818	29819	29840	29841	29842	29843	29844	29845	29846	29848	-
240	23,5 - 28,4	2304,0																



Packing **Drum**

H07V-K drum

Part no.			26825	26826	26827	26828	26829	26830	26831	26832	26833	26834	26835	26836	26837	26838	26840	-
10	5,7 - 6,8	96,0																
Part no.			26841	26842	26843	26844	26845	26846	26847	26848	26849	26850	26851	26852	26853	26854	26856	-
16	6,7 - 8,1	154,0																
Part no.			26857	26858	26859	26860	26861	26862	26863	26864	26865	26866	26867	26868	26869	26870	26872	-
25	8,4 - 10,2	240,0																
Part no.			26873	26874	26875	26876	26877	26878	26879	26880	26881	26882	26883	26884	26885	26886	26888	-
35	9,7 - 11,7	336,0																
Part no.			26889	26890	26891	26892	26893	26894	26895	26896	26897	26898	26899	26900	26901	26902	26904	-
50	11,5 - 13,9	480,0																
Part no.			26905	26906	26907	26908	26909	26910	26911	26912	26913	26914	26915	26916	26917	26918	26920	-
70	13,2 - 16,0	672,0																
Part no.			26921	26922	26923	26924	26925	26926	26927	26928	26929	26930	26931	26932	26933	26934	26936	-
95	15,1 - 18,2	912,0																
Part no.			29305	29306	29307	29308	29309	29310	29311	29312	29313	29314	29315	29316	29317	29318	29320	-
120	16,7 - 20,2	1152,0																
Part no.			29321	29322	29323	29324	29325	29326	29327	29328	29329	29330	29331	29332	29333	29334	29336	-
150	18,6 - 22,5	1440,0																
Part no.			29337	29338	29339	29340	29341	29342	29343	29344	29345	29346	29347	29348	29349	29350	29352	-
185	20,6 - 24,9	1776,0																
Part no.			29353	29354	29355	29356	29357	29358	29359	29360	29361	29362	29363	29364	29365	29366	29368	-
240	23,5 - 28,4	2304,0																
Part no.			28878	28879	28880	28881	28882	28883	28884	28885	28886	28887	28888	-	28889	28890	28891	-
300	26,0 - 30,5	2880,0																

Dimensions and specifications may be changed without prior notice. (RK01)

H05Z-K / H07Z-K

single core, halogen-free



Technical data

- Single cores for low emission of smoke and corrosive gases in case of fire to DIN VDE 0285-525-3-41 / DIN EN 50525-3-41
- **Conductor resistance** acc. to DIN VDE 0295 cl.5
- **Temperature range** -40°C to +90°C
- Permissible conductor **operating temperature** +90°C
- **Nominal voltage**
H05Z-K = U₀/U 300/500 V
H07Z-K = U₀/U 450/750 V
- **Test voltage** 2500 V
- **Insulation resistance** at 90°C to DIN VDE 0282 part 9
- **Minimum bending radius**
fixed installation
core Ø ≤ 8 mm: 4x core Ø
core Ø > 8-12 mm: 5x core Ø
core Ø > 12 mm: 6x core Ø
- **Radiation resistance**
up to 20x10⁶ cJ/kg (up to 20 Mrad)

Cable structure

- Bare Cu-conductor, to DIN VDE 0295 cl.5, fine wire, BS 6360 cl.5, IEC 60228 cl.5
- Separating foil over conductor permitted
- Core insulation of cross-linked polyolefin compound type EI5 to DIN VDE 0207-363-5 / DIN EN 50363-5
- Core identification: see table below
- **LSOH**= Low Smoke Zero Halogen

Properties

- The materials used during manufacturing are cadmium-free, contain no silicone and are free from substances harmful to the wetting properties of lacquers
- ### Tests
- Self-extinguishing and flame retardant acc. o DIN VDE 0482-332-1-2, DIN EN 60332-1-2, IEC 60332-1-2 (equivalent DIN VDE 0472 part 804 test method B)
 - Ozone resistant acc. to DIN VDE 0473-811-403, DIN EN 60811-403
 - Smoke density acc. to DIN VDE 0482 part 1034-1+2, DIN EN 61034-1+2, IEC 61034-1+2, BS 7622 part 1+2 (previously DIN VDE 0472 part 816)
 - Halogen-free acc. to DIN VDE 0285-525-1, DIN EN 50525-1 appendix B

Note

- Type H07Z-K
Colour yellow only as (H)07Z-K available

Application

Halogen-free single-core wires are used for installation in dry environments for wiring up lighting fixtures and units where valuable assets are to be protected from further damage resulting from fire. These types are suitable for laying in tubes on and under plaster, as well as in closed installation ducts.

H07Z-K, suitable for protected, permanent laying in or on lighting installations or switching and control equipment up to 1000 V AC or 750 V DC to earth.

☑ = Product conforms with Low-Voltage Directive 2014/35/EU.

H05Z-K

Cross-sec. mm ²	Outer Ø min. - max. mm	Cop. weight kg / km	Weight app. kg / km	BK	GN-YE	BU	BN	RD	WH	GY	VT	YE	D-BU	OG	U-BU
Part no. 0,5	2,1 - 2,6	4,8	9,0	52872	52873	52874	52875	52876	52877	52878	52879	52880	52945	52946	53071
Part no. 0,75	2,2 - 2,8	7,2	12,4	52881	52882	52883	52884	52885	52886	52887	52888	52889	52947	52948	53072
Part no. 1	2,4 - 2,9	9,6	15,0	52890	52891	52892	52893	52894	52895	52896	52897	52898	52949	52950	53073

H07Z-K

Cross-sec. mm ²	Outer Ø min. - max. mm	Cop. weight kg / km	Weight app. kg / km	BK	GN-YE	BU	BN	RD	WH	GY	VT	YE	D-BU	OG	U-BU
Part no. 1,5	2,8 - 3,5	14,4	24,0	51768	51769	51770	51771	51772	51773	51774	51775	51776	52951	52952	53074
Part no. 2,5	3,4 - 4,3	24,0	35,0	51777	51778	51779	51780	51781	51782	51783	51784	51785	52953	52954	53075
Part no. 4	3,9 - 4,9	38,0	51,0	51786	51787	51788	51789	51790	51791	51792	51793	51794	52955	52956	53076
Part no. 6	4,4 - 5,5	58,0	71,0	51795	51796	51797	51798	51799	51800	51801	51802	51803	52957	52958	53077
Part no. 10	5,7 - 7,1	96,0	118,0	51804	51805	51806	51807	51808	51809	51810	51811	51812	52959	52960	53078
Part no. 16	6,7 - 8,4	154,0	180,0	51813	51814	51815	51816	51817	51818	51819	51820	51821	52961	52962	53079
Part no. 25	8,4 - 10,6	240,0	278,0	51822	51823	51824	51825	51826	51827	51828	51829	51830	52963	52964	53080
Part no. 35	9,7 - 12,1	336,0	375,0	51831	51832	51833	51834	51835	51836	51837	51838	51839	52965	52966	53081
Part no. 50	11,5 - 14,4	480,0	560,0	51840	51841	51842	51843	51844	51845	51846	51847	51848	52967	52968	53082

Continuation ▶

H05Z-K / H07Z-K

single core, halogen-free



H07Z-K

Cross-sec. mm ²	Outer Ø min. - max. mm	Cop. weight kg / km	Weight app. kg / km	BK	GN-YE	BU	BN	RD	WH	GY	VT	YE	D-BU	OG	U-BU
Part no. 70	13,2 - 16,6	672,0	780,0	51849	51850	51851	51852	51853	51854	51855	51856	51857	52969	52970	53083
Part no. 95	15,1 - 18,8	912,0	952,0	51858	51859	51860	51861	51862	51863	51864	51865	51866	52971	52972	53084
Part no. 120	16,7 - 20,9	1152,0	1200,0	51867	51868	51869	51870	51871	51872	51873	51874	51875	52973	52974	53085
Part no. 150	18,6 - 23,3	1440,0	1505,0	51876	51877	51878	51879	51880	51881	51882	51883	51884	52975	52976	53086
Part no. 185	20,6 - 25,8	1776,0	1845,0	51885	51886	51887	51888	51889	51890	51891	51892	51893	52977	52978	53087
Part no. 240	23,5 - 29,4	2304,0	2400,0	51894	51895	51896	51897	51898	51899	51900	51901	51902	52979	52980	53088

H05Z-K, barrel (with various capacity)

Cross-sec. mm ²	Outer Ø min. - max. mm	Cop. weight kg / km	Weight app. kg / km	RD/WH	BU/WH	BN/WH	D-BU/WH
Part no. 0,5	2,1 - 2,6	4,8	9,0	51392	51393	51394	51395
Part no. 0,75	2,2 - 2,8	7,2	12,4	51396	51397	51398	51399
Part no. 1	2,2 - 2,8	9,6	15,0	51400	51401	51402	51403

H07Z-K, barrel (with various capacity)

Cross-sec. mm ²	Outer Ø min. - max. mm	Cop. weight kg / km	Weight app. kg / km	RD/WH	BU/WH	BN/WH	D-BU/WH
Part no. 1,5	2,8 - 3,5	14,4	24,0	51404	51405	51406	51407
Part no. 2,5	3,4 - 4,3	24,0	35,0	51408	51409	51410	51411
Part no. 4	3,9 - 4,9	38,0	51,0	51412	51413	51414	51415
Part no. 6	4,4 - 5,5	58,0	71,0	51416	51417	51418	50899

H05Z-K two colour

Cross-sec. mm ²	Outer Ø min. - max. mm	Cop. weight kg / km	Weight app. kg / km	BK	GN-YE	BU	BN	RD	WH	GY	VT	YE	D-BU	OG	U-BU
Part no. 0,5	2,1 - 2,6	4,8	9,0	52809	52810	52811	52812	52813	52814	52815	52816	-	52817	52819	-
Part no. 0,75	2,2 - 2,8	7,2	12,4	52821	52822	52823	52824	52825	52826	52827	52828	-	52829	52831	-
Part no. 1	2,4 - 2,9	9,6	15,0	52833	52834	52835	52836	52837	52838	52839	52840	-	52841	52843	-

H07Z-K two colour

Cross-sec. mm ²	Outer Ø min. - max. mm	Cop. weight kg / km	Weight app. kg / km	BK	GN-YE	BU	BN	RD	WH	GY	VT	YE	D-BU	OG	U-BU
Part no. 1,5	2,8 - 3,5	14,4	24,0	52845	52846	52847	52848	52849	52850	52851	52852	-	52853	52855	-
Part no. 2,5	3,4 - 4,3	24,0	35,0	52857	52858	52859	52860	52861	52862	52863	52864	-	52865	52867	-
Part no. 4	3,9 - 4,9	38,0	51,0	52135	52136	52137	52138	52139	52140	52141	52142	-	52143	52144	-
Part no. 6	4,4 - 5,5	58,0	71,0	52145	52146	52147	52148	52149	52150	52151	52152	-	52153	52154	-

Dimensions and specifications may be changed without prior notice. (RK01)

FIVENORM

HAR-UL-CSA-AWM-MTW, PVC single core, UL Style 10269/UL Standard 1063, 600 V, 105°C



Technical data

- PVC-single cores acc. to DIN VDE 0285-525-2-31/ DIN EN 50525-2-31, UL Std.1063, UL Style 10269 and CSA-TEW and CSA-AWM I A/B
- **Temperature range**
H05V2-K / H07V2-K
flexing +5°C to +90°C
fixed installation -40°C to +90°C
UL (AWM) -40°C to +105°C
UL (MTW) -40°C to +90°C
CSA (TEW) -40°C to +105°C
- **Nominal voltage**
up to 1 mm² H05V2-K: U₀/U 300/500 V
from 1,5 mm² H07V2-K: U₀/U 450/750 V
UL (AWM) 1000 V (AC)
UL (AWM) 1250 V (DC)
UL (MTW) 600 V
CSA (TEW) 600 V
- **Test voltage**
H05V2-K = 2000 V
H07V2-K = 2500 V
- **Test voltage** (Spark Test)
0,5 mm² = 5 kV
≥ 0,75 mm² = 6 kV
- **Insulation resistance**
min. 20 MΩm x km
- **Minimum bending radius**
fixed installation for core Ø:
≤ 8 mm: 4x core Ø
> 8-12 mm: 5x core Ø
> 12 mm: 6x core Ø

Cable structure

- Bare copper fine wire stranded to DIN VDE 0295 cl.5, BS 6360 cl.5 and IEC 60228 cl.5, acc. to UL Std.758
- Core insulation of PVC compound type T13 to DIN VDE 0207-363-3/DIN EN 50363-3 CSA-C 22.2 No. 210 tab.12 class H and class 43 acc. to UL Std.1581
- Core identification to DIN VDE 0293

Properties

- The materials used during manufacturing are cadmium-free, contain no silicone and are free from substances harmful to the wetting properties of lacquers
- Tests**
- PCV self-extinguishing and flame retardant acc. to DIN VDE 0482-332-1-2, DIN EN 60332-1-2, IEC 60332-1-2 (equivalent DIN VDE 0472 part 804 test method B), UL VW-1, CSA FT1

Note

- Tinned conductor on request.
- up to = 1,0 mm² = H05V2-K, from 1,5 mm² up to 35 mm² = H07V2-K. Cross-sections up to 35 mm² is acc. to DIN VDE 0285-525-2-31. Due to this cross section >35 mm² is the type H07V-K but with an increased heat-resistant PVC-compound T13.
- **Type H05V:**
approved one-colour mark: black, blue, brown, grey, orange, pink, red, turquoise, violet, white, green and yellow.
Two-coloured mark in any combination of the above individual colours.
- **Type H07V:**
approved mark: black, blue, brown, grey, orange, pink, red, turquoise, violet, white and green-yellow.
Other marks are available as (H).

Application

Five norms approved connecting jumper wire primarily designed for exportes, used in machine tools. The approbation of HAR, UL-AWM, UL-MTW, CSA-AWM, CSA-Equipment-wire make possible an economical storekeeping and simplification of parts list.

☑ = Product conforms with Low-Voltage Directive 2014/35/EU.

Cross-sec. mm ² / AWG-no.	Outer Ø app. mm	Cop. weight kg / km	BK	GN-YE	BU	BN	RD	WH	GY	VT	YE	PK	GN	TRANS	D-BU	OG	o.col.	2-col.
app. RAL			9005	-	5015	8003	3000	1013	7000	4005	1021	3015	6018	-	5010	2003	-	-
Part no.			64075	64076	64077	64078	64079	64080	64081	64082	64083	64084	64085	64086	64087	64088	64089	64090
0,5 / 22	2,5	5,2																
Part no.			64091	64092	64093	64094	64095	64096	64097	64098	64099	64100	64101	64102	64103	64104	64105	64106
0,75 / 20	2,65	7,2																
Part no.			64107	64108	64109	64110	64111	64112	64113	64114	64115	64116	64117	64118	64119	64120	64121	64122
1 / 18	2,8	9,6																

Continuation ▶

FIVENORM

HAR-UL-CSA-AWM-MTW, PVC single core, UL Style 10269/UL Standard 1063, 600 V, 105°C



Cross-sec. mm² / AWG-no. app. RAL	Outer Ø app. mm	Cop. weight kg / km	BK	GN-YE	BU	BN	RD	WH	GY	VT	YE	PK	GN	TRANS	D-BU	OG	o.col.	2-col.
Part no. 1,5 / 16	3,05	14,4	9005 64123	- 64124	5015 64125	8003 64126	3000 64127	1013 64128	7000 64129	4005 64130	1021 64131	3015 64132	6018 64133	- 64134	5010 64135	2003 64136	- 64137	- 64138
Part no. 2,5 / 14	3,6	24,0	64139	64140	64141	64142	64143	64144	64145	64146	64147	64148	64149	64150	64151	64152	64153	64154
Part no. 4 / 12	4,1	38,0	64155	64156	64157	64158	64159	64160	64161	64162	64163	64164	64165	64166	64167	64168	64169	64170
Part no. 6 / 10	4,8	58,0	64171	64172	64173	64174	64175	64176	64177	64178	64179	64180	64181	64182	64183	64184	64185	64186
Part no. 10 / 8	6,4	96,0	64187	64188	64189	64190	64191	64192	64193	64194	64195	64196	64197	64198	64199	64200	64201	64202
Part no. 16 / 6	8,1	154,0	64203	64204	64205	64206	64207	64208	64209	64210	64211	64212	64213	64214	64215	64216	64217	64218
Part no. 25 / 4	9,6	240,0	64219	64220	64221	64222	64223	64224	64225	64226	64227	64228	64229	64230	64231	64232	64233	64234
Part no. 35 / 2	10,8	336,0	64235	64236	64237	64238	64239	64240	64241	64242	64243	64244	64245	64246	64247	64248	64249	64250
Part no. 50 / 1	13,6	480,0	64251	64252	64253	64254	64255	64256	64257	64258	64259	64260	64261	64262	64263	64264	64265	64266
Part no. 70 / 2/0	15,2	672,0	64267	64268	64269	64270	64271	64272	64273	64274	64275	64276	64277	64278	64279	64280	64281	64282
Part no. 95 / 3/0	16,8	912,0	64283	64284	64285	64286	64287	64288	64289	64290	64291	64292	64293	64294	64295	64296	64297	64298
Part no. 120 / 4/0	19,5	1152,0	64299	64300	64301	64302	64303	64304	64305	64306	64307	64308	64309	64310	64311	64312	64313	64314
Part no. 150 / 300 kcmil	22,2	1440,0	64315	64316	64317	64318	64319	64320	64321	64322	64323	64324	64325	64326	64327	64328	64329	64330

Barrel (with various capacity)

Cross-sec. mm² / AWG-no. app. RAL	Outer Ø app. mm	Cop. weight kg / km	BK	GN-YE	BU	BN	RD	WH	GY	VT	YE	PK	GN	TRANS	D-BU	OG	o.col.	2-col.
Part no. 0,5 / 22	2,5	5,2	9005 65402	- 65403	5015 65404	8003 65405	3000 65406	1013 65407	7000 65408	4005 65409	1021 65413	3015 65410	6018 65412	- 65414	5010 65411	2003 65411	- 65411	- 65411
Part no. 0,75 / 20	2,65	7,2	65415	65416	65417	65418	65419	65420	65421	65422	65426	65423	65425	65427	65428	65429	65430	65431
Part no. 1 / 18	2,8	9,6	65428	65429	65430	65431	65432	65433	65434	65435	65439	65436	65438	65440	65437	65438	65439	65440

Barrel (with various capacity)

Cross-sec. mm² / AWG-no. app. RAL	Outer Ø app. mm	Cop. weight kg / km	BK	GN-YE	BU	BN	RD	WH	GY	VT	YE	PK	GN	TRANS	D-BU	OG	o.col.	2-col.
Part no. 1,5 / 16	3,05	14,4	9005 65441	- 65442	5015 65443	8003 65444	3000 65445	1013 65446	7000 65447	4005 65448	1021 65452	3015 65449	6018 65451	- 65453	5010 65453	2003 65450	- 65453	- 65450
Part no. 2,5 / 14	3,6	24,0	65454	65455	65456	65457	65458	65459	65460	65461	65465	65462	65464	65466	65467	65468	65469	65470
Part no. 4 / 12	4,1	38,0	65467	65468	65469	65470	65471	65472	65473	65474	65478	65475	65477	65479	65480	65481	65482	65483
Part no. 6 / 10	4,8	58,0	65550	65551	65552	65553	65554	65555	65556	65557	65558	65559	65560	65561	65562	65563	65564	65565

Two colour

Cross-sec. mm² / AWG-no. app. RAL	Outer Ø app. mm	Cop. weight kg / km	BU/WH	WH/BU	D-BU/WH	WH/OG	WH/RD	BK/OG	D-BU/OG	RD/WH	WH/D-BU	YE/BN	OG/BU
Part no. 0,5 / 22	2,5	5,2	63402	63403	63404	63405	63406	63482	63332	63352	63372	65386	69625
Part no. 0,75 / 20	2,65	7,2	63407	63408	63409	63410	63411	63483	63333	63353	63373	65387	69626
Part no. 1 / 18	2,8	9,6	63412	63413	63414	63415	63416	63484	63334	63354	63374	65388	69627

Two colour

Cross-sec. mm² / AWG-no. app. RAL	Outer Ø app. mm	Cop. weight kg / km	WH/YE	OG/D-BU	YE/BU	BU/OG	OG/RD	OG/BK	OG/WH	YE/RD	BK/YE
Part no. 0,5 / 22	2,5	5,2	69827	69828	69829	69830	69831	69832	69833	69834	69835
Part no. 0,75 / 20	2,65	7,2	69836	69837	69838	69839	69840	69841	69842	69843	69844
Part no. 1 / 18	2,8	9,6	69845	69846	69847	69848	69849	69850	69851	69852	69853

Continuation ►

FIVENORM

HAR-UL-CSA-AWM-MTW, PVC single core, UL Style 10269/UL Standard 1063, 600 V, 105°C



Two colour

Cross-sec. mm ² / AWG-no. app. RAL	Outer Ø app. mm	Cop. weight kg / km	BU/WH	WH/BU	D-BU/WH	WH/OG	WH/RD	BK/OG	D-BU/OG	RD/WH	WH/D-BU	YE/BN	OG/BU
Part no. 1,5 / 16	3,05	14,4	63417	63418	63419	63420	63421	63485	63335	63355	63375	65389	69628
Part no. 2,5 / 14	3,6	24,0	63422	63423	63424	63425	63426	63486	63336	63356	63376	65390	69629
Part no. 4 / 12	4,1	38,0	63427	63428	63429	63430	63431	63487	63337	63357	63377	65391	69630
Part no. 6 / 10	4,8	58,0	63432	63433	63434	63435	63436	63488	63338	63358	63378	65392	69655
Part no. 10 / 8	6,4	96,0	63437	63438	63439	63440	63441	63489	63339	63359	63379	65393	69656
Part no. 16 / 6	8,1	154,0	63442	63443	63444	63445	63446	63490	63340	63360	63380	65394	69657
Part no. 25 / 4	9,6	240,0	63447	63448	63449	63450	63451	63491	63342	63362	63382	65395	69658
Part no. 35 / 2	10,8	336,0	63452	63453	63454	63455	63456	63492	63343	63363	63383	65396	69659
Part no. 50 / 1	13,6	480,0	63457	63458	63459	63460	63461	63493	63344	63364	63384	65397	69660
Part no. 70 / 2/0	15,2	627,0	63462	63463	63464	63465	63466	63494	63345	63365	63385	65398	69738
Part no. 95 / 3/0	16,8	912,0	63467	63468	63469	63470	63471	63495	63346	63366	63386	65499	69739
Part no. 120 / 4/0	19,5	1152,0	63472	63473	63474	63475	63476	63496	63347	63367	63387	65400	69740
Part no. 150 / 300 kcmil	22,2	1440,0	63477	63478	63479	63480	63481	63497	63348	63368	63388	65401	69741

Two colour

Cross-sec. mm ² / AWG-no. app. RAL	Outer Ø app. mm	Cop. weight kg / km	WH/YE	OG/D-BU	YE/BU	BU/OG	OG/RD	OG/BK	OG/WH	YE/RD	BK/YE
Part no. 1,5 / 16	3,05	14,4	69854	69855	69856	69857	69858	69859	69860	69861	69862
Part no. 2,5 / 14	3,6	24,0	69863	69864	69865	69866	69867	69868	69869	69870	69871
Part no. 4 / 12	4,1	38,0	69872	69873	69874	69875	69876	69877	69878	69879	69880
Part no. 6 / 10	4,8	58,0	69881	69882	69883	69884	69885	69886	69887	69888	69889
Part no. 10 / 8	6,4	96,0	69890	69891	69892	69893	69894	69895	69896	69897	69898
Part no. 16 / 6	8,1	154,0	69899	69900	69901	69902	69903	69904	69905	69906	69907

Two colour, barrel (with various capacity)

Cross-sec. mm ² / AWG-no. app. RAL	Outer Ø app. mm	Cop. weight kg / km	BU/WH	WH/BU	D-BU/WH	WH/OG	WH/RD	BK/OG	D-BU/OG	RD/WH	WH/D-BU	YE/BN	OG/BU
Part no. 0,5 / 22	2,5	5,2	65479	65480	65481	65482	65483	65484	65485	65486	65487	65488	65489
Part no. 0,75 / 20	2,65	7,2	65490	65491	65492	65493	65494	65495	65496	65497	65498	65502	65503
Part no. 1 / 18	2,8	9,6	65504	65505	65506	65507	65508	65509	65510	65511	65512	65514	65515

Two colour, barrel (with various capacity)

Cross-sec. mm ² / AWG-no. app. RAL	Outer Ø app. mm	Cop. weight kg / km	BU/WH	WH/BU	D-BU/WH	WH/OG	WH/RD	BK/OG	D-BU/OG	RD/WH	WH/D-BU	YE/BN	OG/BU
Part no. 1,5 / 16	3,05	14,4	65516	65517	65518	65519	65520	65521	65522	65523	65524	65525	65526
Part no. 2,5 / 14	3,6	24,0	65527	65528	65529	65530	65531	65532	65533	65534	65535	65536	65537
Part no. 4 / 12	4,1	38,0	65538	65539	65540	65541	65542	65543	65544	65545	65546	65547	65548

Dimensions and specifications may be changed without prior notice. (RN06)

HELUTHERM® 145

flexible, cross-linked, halogen-free



Technical data

- Halogen-free single cores with increased heat resistance
- **Temperature range**
flexing -35°C to +120°C
fixed installation -55°C to +145°C
- **Nominal voltage**
up to 1 mm² = U₀/U 300/500 V
from 1,5 mm² = U₀/U 450/ 750 V
at fixed and protected installation
from 1,5 mm² = U₀/U 600/1000 V
- **Test voltage**
3500 V
- **Minimum bending radius**
flexing 12,5x core Ø
fixed installation 4x core Ø
- **Caloric load values**
see "Technical Informations"
- **Approval**
Germanischer Lloyd

Cable structure

- Tinned copper conductor, to DIN VDE 0295 cl.5, fine wire, BS 6360 cl.5, IEC 60228 cl.5
- Core insulation of polyolefin-copolymer cross-linked and halogen-free
- Core identification, see table below

Tests

- Flame test (unit flame test) acc. to DIN VDE 0482-332-3-22, BS 4066 Teil 3, DIN EN 60332-3-22, IEC 60332-3-22 (previously DIN VDE 0472 part 804 test method C)
- Flame test (cable) acc. to DIN VDE 0482-332-1-2, DIN EN 60332-1-2, IEC 60332-1-2 (equivalent DIN VDE 0472 part 804 test method B)
- Corrosiveness of combustion gases acc. to DIN VDE 0482 part 267, DIN EN 50267-2-2, IEC 60754-2 (equivalent DIN VDE 0472 part 813)
- Halogen-free acc. to DIN VDE 0482 part 267, DIN EN 50267-2-1, IEC 60754-1 (equivalent DIN VDE 0472 part 815)
- Smoke density acc. to DIN VDE 0482 part 1034-1+2, DIN EN 61034-1+2, IEC 61034-1+2, BS 7622 part 1+2 (previously DIN VDE 0472 part 816)

Properties

- Lower propagation of fire
- Low development of smoke and fumes
- Good abrasion and notch resistance
- Good resistance to oils and weathering
- Resistant to UV radiation and ozone
- Resistant to soldering temperatures
- Thermal class B
- These single-core cables are resistant to melting, even when in contact with a soldering iron at temperatures of between 300°C and 380°C, because of the cross-linking for the insulation material
- Due to the high temperature profile the cross section of conductor can under certain circumstances be reduced, hereby enabling a saving in space requirement and weight
- The materials used during manufacturing are cadmium-free, contain no silicone and are free from substances harmful to the wetting properties of lacquers

Application

These temperature resistant single-core cables are used for the internal wiring of lighting fixtures, heaters, electrical machinery, switching systems and distributors in equipment and plant and machinery, suitable for laying in tubes on and under plaster, in closed installation ducts, as well as for traffic systems and outdoor applications. These cables are not approved for direct routing on racks, gutters or tanks. These halogen-free single core cables are characterised by their amazingly high long-time resistance to temperature and feature among the leading halogen-free, flame resistant products in the world. These single core cables significantly contribute to safety and the environment.

☑️ = Product conforms with Low-Voltage Directive 2014/35/EU.

Cross-sec. mm ²	Outer Ø app. mm	Cop. weight kg / km	Weight app. kg / km	BK	GN-YE	BU	BN	RD	WH	GY	VT	YE	GN	D-BU	OG	BEIGE	2-col.
Part no. 0,25	1,6	2,4	4,0	50999	50998	51070	51071	51072	51073	51074	51075	51076	51078	51079	51077	51164	51165
Part no. 0,34	1,7	3,2	5,0	51167	51166	51168	51169	51170	51171	51172	51173	51174	51176	51177	51175	51178	51179
Part no. 0,5	1,9	4,8	7,0	51281	51280	51282	51283	51284	51285	51286	51287	51288	51290	51291	51289	51292	51293
Part no. 0,75	2,2	7,2	11,0	51295	51294	51296	51297	51298	51299	51300	51301	51302	51304	51305	51303	51306	51307
Part no. 1	2,5	9,6	14,0	51309	51308	51310	51311	51312	51313	51314	51315	51316	51318	51319	51317	51320	51321
Part no. 1,5	2,9	14,4	20,0	51323	51322	51324	51325	51326	51327	51328	51329	51330	51332	51333	51331	51334	51335
Part no. 2,5	3,5	24,0	30,0	51337	51336	51338	51339	51340	51341	51342	51343	51344	51346	51347	51345	51348	51349
Part no. 4	4,3	38,0	47,0	51351	51350	51352	51353	51354	51355	51356	51357	51358	51360	51361	51359	51362	51363
Part no. 6	5,0	58,0	72,0	51365	51364	51366	51367	51368	51369	51370	51371	51372	51374	51375	51373	51376	51377
Part no. 10	6,3	96,0	120,0	51379	51378	51380	51381	51382	51383	51384	51385	51386	51388	51389	51387	51390	51391

Continuation ▶

HELUTHERM® 145

flexible, cross-linked, halogen-free



Cross-sec. mm ²	Outer Ø app. mm	Cop. weight kg / km	Weight app. kg / km	BK	GN-YE	BU	BN	RD	WH	GY	VT	YE	GN	D-BU	OG	BEIGE	2-col.
Part no. 16	7,3	154,0	182,0	51420	51419	51421	51422	51423	51424	51425	51426	51427	51429	51430	51428	51431	51432
Part no. 25	9,6	240,0	272,0	51434	51433	51435	51436	51437	51438	51439	51440	51441	51443	51444	51442	51445	51446
Part no. 35	10,8	336,0	371,0	51448	51447	51449	51450	51451	51452	51453	51454	51455	51457	51458	51456	51459	51460
Part no. 50	12,6	480,0	530,0	51462	51461	51463	51464	51465	51466	51467	51468	51469	51471	51472	51470	51473	51474
Part no. 70	14,6	672,0	730,0	51476	51475	51477	51478	51479	51480	51481	51482	51483	51485	51486	51484	51487	51488
Part no. 95	16,5	912,0	964,0	51490	51489	51491	51492	51493	51494	51495	51496	51497	51499	51500	51498	51501	51502
Part no. 120	18,0	1152,0	1235,0	51504	51503	51505	51506	51507	51508	51509	51510	51511	51513	51514	51512	51515	51516
Part no. 150	20,0	1440,0	1523,0	51518	51517	51519	51520	51521	51522	51523	51524	51525	51527	51528	51526	51529	51530
Part no. 185	22,2	1776,0	1850,0	51532	51531	51533	51534	51535	51536	51537	51538	51539	51541	51542	51540	51543	51544
Part no. 240	24,5	2304,0	2432,0	51546	51545	51547	51548	51549	51550	51551	51552	51553	51555	51556	51554	51557	51558

Dimensions and specifications may be changed without prior notice. (RK01)

HELUTHERM® 145

600 V, flexible single core, cross-linked, halogen-free

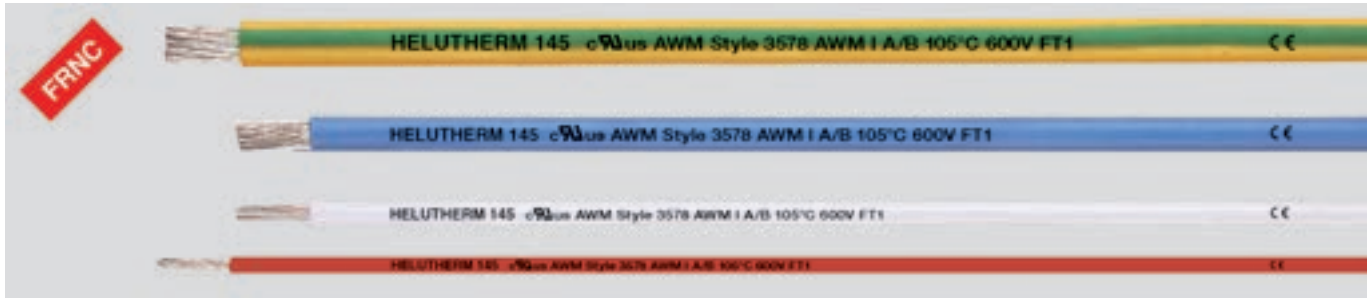

Technical data

- Halogen-free single cores with increased heat resistance acc. to UL Style 3578 CSA C22.2 No. 210
- **Temperature range**
flexing -35°C to +120°C
fixed installation -55°C to +145°C
UL/CSA
flexing -35°C to +105°C
fixed installation -55°C to +105°C
- **Nominal voltage**
600 V
- **Test voltage**
3000 V
- **Minimum bending radius**
flexing 12,5x core Ø
fixed installation 4x core Ø
- **Caloric load values**
see "Technical Informations"
- **Power ratings table**
see "Technical Informations"
- **Approval**
Germanischer Lloyd

Cable structure

- Tinned Cu wires, acc. to DIN VDE 0295 cl.5, BS 6360 cl.5 and IEC 60228 cl.5
 - Core insulation of cross-linked polyolefin-copolymer
 - Core identification, see table below
- Tests**
- Flame test acc. to DIN VDE 0482-332-3-22, BS 4066 part 3, DIN EN 60332-3-22, IEC 60332-3-22 (previously DIN VDE 0472 part 804 test method C)
 - Corrosiveness of combustion gases acc. to DIN VDE 0482 part 267, DIN EN 50267-2-2, IEC 60754-2 (equivalent DIN VDE 0472 part 813)
 - Halogen-free acc. to DIN VDE 0482 part 267, DIN EN 50267-2-1, IEC 60754-1 (equivalent DIN VDE 0472 part 815)
 - Smoke density acc. to DIN VDE 0482 part 1034-1+2, DIN EN 61034-1+2, IEC 61034-1+2, BS 7622 part 1+2 (previously DIN VDE 0472 part 816)

Properties

- Halogen-free
- Lower propagation of fire
- Low development of smoke and fumes
- Good abrasion and notch resistance
- Good resistance to oils and weathering
- Resistant to UV radiation and ozone
- Resistant to soldering temperatures
- Resistant to melting, even when in contact with a soldering iron at temperatures of between 300°C and 380°C, because of the cross-linking for the insulation material
- Due to the high temperature profile the cross section of conductor can under certain circumstances be reduced, hereby enabling a saving in space requirement and weight
- The materials used during manufacturing are cadmium-free, contain no silicone and are free from substances harmful to the wetting properties of lacquers

Application

These temperature resistant single-core cables are used for the internal wiring of lighting fixtures, heaters, electrical machinery, switching systems and distributors in equipment and plant and machinery, suitable for installation on, in and beneath plaster, in closed installation ducts, as well as for traffic systems and outdoor applications. These cables are not approved for direct routing on racks, gutters or tanks. These halogen-free single core cables are characterised by their amazingly high long-time resistance to temperature and feature among the leading halogen-free, flame resistant products in the world.

☑ = Product conforms with Low-Voltage Directive 2014/35/EU.

Cross-sec. mm²	Outer Ø app. mm	Cop. weight kg / km	Weight app. kg / km	BK	GN-YE	BU	BN	RD	WH	GY	VT	YE	PK	GN	OG	BEIGE	2-col.
Part no. 0,25	2,3	2,4	7,0	59473	59472	59474	59475	59476	59477	59478	59479	59480	59483	59482	59481	59484	59485
Part no. 0,5	2,6	4,8	11,0	59487	59486	59488	59489	59490	59491	59492	59493	59494	59497	59496	59495	59498	59499
Part no. 0,75	2,8	7,2	14,0	59501	59500	59502	59503	59504	59505	59506	59507	59508	59511	59510	59509	59512	59513
Part no. 1	2,9	9,6	17,0	59515	59514	59516	59517	59518	59519	59520	59521	59522	59525	59524	59523	59526	59527
Part no. 1,5	3,1	14,4	22,0	59529	59528	59530	59531	59532	59533	59534	59535	59536	59539	59538	59537	59540	59541
Part no. 2,5	3,6	24,0	33,0	59543	59542	59544	59545	59546	59547	59548	59549	59550	59553	59552	59551	59554	59555
Part no. 4	4,3	38,4	53,0	59557	59556	59558	59559	59560	59561	59562	59563	59564	59567	59566	59565	59568	59569
Part no. 6	5,0	57,6	78,0	59571	59570	59572	59573	59574	59575	59576	59577	59578	59581	59580	59579	59582	59583
Part no. 10	6,4	96,0	136,0	59585	59584	59586	59587	59588	59589	59590	59591	59592	59595	59594	59593	59596	59597
Part no. 16	7,5	154,0	203,0	59599	59598	59600	59601	59602	59603	59604	59605	59606	59609	59608	59607	59610	59611
Part no. 25	9,6	240,0	300,0	59613	59612	59614	59615	59616	59617	59618	59619	59620	59623	59622	59621	59624	59625
Part no. 35	10,8	336,0	405,0	59627	59626	59628	59629	59630	59631	59632	59633	59634	59637	59636	59635	59638	59639
Part no. 50	12,6	480,0	580,0	59641	59640	59642	59643	59644	59645	59646	59647	59648	59651	59650	59649	59652	59653

Dimensions and specifications may be changed without prior notice. (RN06)

THHN / THWN

90°C, 600 V, UL listed, PVC + nylon single core



Technical data

- PVC + Nylon insulated single cores to UL Std.83 and UL Std.1063 (MTW)
- **Temperature range**
THHN dry environments: 90°C
THWN wet environments: 75°C
- **Nominal voltage**
600 V
- **Minimum bending radius**
8x core Ø
- **Test voltage** (Spark test)
 AWG 14 to AWG 10 = 7,5 kV
 AWG 8 to AWG 2/0 = 10 kV
 AWG 3/0 to AWG 4/0 = 12,5 kV
 kcmil 250 to kcmil 500 = 15 kV
 kcmil 600 to kcmil 1000 = 17,5 kV

Cable structure

- Bare copper conductor, with AWG dimensions
- Core insulation of PVC and Nylon-sheath
- Core identification coloured

Properties

Resistant against

- Oils
- Gasoline
- Water
- Acids
- Ozone
- Lyes
- Sunlight
- Abrasion

Note

- 1 kcmil = 1000 circ mils = 0,5067 mm².
- Please complete the part number for these cables by adding the suffix for the colour required as per the list:
 0 = green
 1 = black
 2 = blue
 3 = brown
 4 = red
 5 = white
 6 = grey
 7 = yellow
 8 = orange
 9 = pink

Application

For the electrical installation of machine tools and the relative control. THWN = Thermoplastic PVC-insulated building wire, Heat resistant 75°C, for Wet and dry locations, flame retardant. THHN = Thermoplastic PVC-insulated building wire, Nylon sheath, 90°C, 600 V, for dry and damp locations.
 ☞☞ = Product conforms with Low-Voltage Directive 2014/35/EU.

Part no.	Cross-section mm ²	AWG-No.	Cond. make-up n x wire Ø	Outer Ø app. mm	Cop. weight kg / km	Weight app. kg / km
6320x	2,08	14	19 x 0,38	3,0	20,7	25,0
6321x	3,32	12	19 x 0,48	3,4	33,0	37,0
6322x	5,26	10	19 x 0,6	4,3	51,6	60,0
6323x	8,35	8	19 x 0,75	5,5	80,6	95,0
6324x	13,39	6	19 x 0,96	6,6	125,0	143,0
6325x	21,14	4	19 x 1,19	8,4	201,0	229,0
6326x	26,65	3	19 x 1,336	9,1	253,0	282,0
6327x	33,61	2	19 x 1,5	10,0	317,0	349,0
6328x	42,38	1	19 x 1,686	11,4	399,0	449,0
6329x	53,47	1/0	19 x 1,89	12,4	500,0	557,0
6330x	67,4	2/0	19 x 2,126	13,7	631,0	691,0
6331x	84,97	3/0	19 x 2,387	15,0	792,0	861,0
6332x	107,17	4/0	19 x 2,68	16,5	996,0	1069,0

Part no.	Cross-section mm ²	AWG-No.	Cond. make-up n x wire Ø	Outer Ø app. mm	Cop. weight kg / km	Weight app. kg / km
63331	127	250 kcmil	37 x 2,088	18,29	1178,0	1277,0
63341	152	300 kcmil	37 x 2,286	19,56	1410,0	1515,0
63351	178	350 kcmil	37 x 2,47	21,08	1645,0	1753,0
63361	203	400 kcmil	37 x 2,7	22,35	1902,0	1998,0
63371	254	500 kcmil	37 x 2,95	24,13	2345,0	2466,0
63381	304	600 kcmil	61 x 2,52	26,75	2920,0	3000,0
63391	380	750 kcmil	61 x 2,82	29,36	3658,0	3713,0
63401	507	1000 kcmil	61 x 3,25	33,27	4858,0	4870,0

Dimensions and specifications may be changed without prior notice. (RN06)

DATAFLAMM

SUPER-PAAR-TRONIC-C-PUR

DATAFLAMM-C

Control cable UL (LiYY-TP)

PAAR-TRONIC-CY

DATAFLAMM-C-PAAR



■ DATA CABLES

Designation	Page
PAAR-TRONIC-CY	170
DATAFLAMM®	172
DATAFLAMM®-C	173
DATAFLAMM®-C-PAAR	174
Command Cable UL (LiYY)	175
Command Cable UL (LiCY)	176
Command Cable UL (LiYY-TP)	178
Command Cable UL (LiCY-TP)	180
SUPERTRONIC® -PURö	182
SUPERTRONIC® -C-PURö	183
SUPERTRONIC®-330 PURö	184
SUPERTRONIC®-330 C-PURö	185
SUPER-PAAR-TRONIC-C-PUR®	186
SUPER-PAAR-TRONIC 340-C-PUR	187

PAAR-TRONIC-CY

EMC-preferred type, flexible, Cu-screened, colour coded to DIN 47100, meter marking



Technical data

- Special PVC data cables for electronic control adapted to DIN VDE 0812 and 0814
- **Temperature range**
flexing -5°C to +80°C
fixed installation -30°C to +80°C
- **Operating peak voltage**
(not for heavy current installation purposes)
350 V
- **Test voltage**
core/core 1200 V
core/screen 800 V
- **Breakdown voltage**
min. 2400 V
- **Insulation resistance**
min. 20 MOhm x km
- **Plant capacity** (approx.-value) at 800 Hz
core/core 0,14 mm² = 120 pF/m
core/core 0,25 mm² = 150 pF/m
core/screen 0,14 mm² = 240 pF/m
core/screen 0,25 mm² = 270 pF/m
- **Inductance**
approx. 0,65 mH/km
- **Impedance**
approx. 78 Ohm
- **K₁-coupling**
approx. 300 pF/100 m
- **Coupling resistance**
max. 250 Ohm/km
- **Minimum bending radius**
flexing 10x cable Ø
fixed installation 5x cable Ø
- **Radiation resistance**
up to 80x10⁶ cJ/kg (up to 80 Mrad)

Cable structure

- Bare copper conductor, from 0,5 mm² to DIN VDE 0295 cl.5, fine wire, BS 6360 cl.5, IEC 60228 cl.5
- Conductor construction:
0,14 mm² = 18x0,1 mm
0,25 mm² = 14x0,15 mm
0,34 mm² = 7x0,25 mm
- Core insulation of special PVC compound type T12 to DIN VDE 0207-363-3 / DIN EN 50363-3
- Core identification (pair) to DIN 47100
- Cores stranded in pairs with optimal lay length
- Pairs stranded in layers with optimal lay length
- Foil wrapping
- Drain wire, tinned
- Tinned copper braided screen, approx. 85% coverage
- Outer sheath of special PVC compound type TM2 to DIN VDE 0207-363-4-1/DIN EN 50363-4-1
- Sheath colour: grey (RAL 7032) also available in other colours on request
- With meter marking

Properties

- Extensively oil resistant, oil-/chemical resistance see "Technical Informations"
- The materials used during manufacturing are cadmium-free, contain no silicone and are free from substances harmful to the wetting properties of lacquers

Tests

- PCV self-extinguishing and flame retardant acc. to DIN VDE 0482-332-1-2, DIN EN 60332-1-2, IEC 60332-1-2 (equivalent DIN VDE 0472 part 804 test method B)

Note

- AWG sizes are approximate equivalent values. The actual cross section is in mm².
- Unscreened analogue type:
PAAR-TRONIC

Application

These data control cables are used for flexible use with free movement without tensile stress or forced movements in dry, moist and wet rooms but not suitable for open air. PAAR-TRONIC-CY is well suited for use in areas subject to signal interference. The high level of screening reduces substantially the effects of electrical disturbances from parallel running wiring etc. The copper screening is also often used as an "earth". The twisted pairs conform favourable cross-talk attenuation values.

EMC = Electromagnetic compatibility

To optimize the EMC features we recommend a large round contact of the copper braiding on both ends.

= Product conforms with Low-Voltage Directive 2014/35/EU.

Part no.	No. pairs x cross-sec. mm ²	Outer Ø app. mm	Cop. weight kg / km	Weight app. kg / km	AWG-No.
21001	1 x 2 x 0,14	4,0	15,6	34,0	26
21002	2 x 2 x 0,14	5,0	18,5	40,0	26
21003	3 x 2 x 0,14	5,7	23,0	49,0	26
21004	4 x 2 x 0,14	6,1	26,6	55,0	26
21005	5 x 2 x 0,14	6,8	30,7	66,0	26

Part no.	No. pairs x cross-sec. mm ²	Outer Ø app. mm	Cop. weight kg / km	Weight app. kg / km	AWG-No.
21006	6 x 2 x 0,14	7,2	48,5	86,0	26
21007	7 x 2 x 0,14	7,2	51,1	91,0	26
21008	8 x 2 x 0,14	8,2	53,7	97,0	26
21009	10 x 2 x 0,14	9,1	59,0	109,0	26
21010	12 x 2 x 0,14	9,6	66,0	141,0	26

Continuation ▶

PAAR-TRONIC-CY

EMC-preferred type, flexible, Cu-screened, colour coded to DIN 47100, meter marking



Part no.	No.pairs x cross-sec. mm ²	Outer Ø app. mm	Cop. weight kg / km	Weight app. kg / km	AWG-No.	Part no.	No.pairs x cross-sec. mm ²	Outer Ø app. mm	Cop. weight kg / km	Weight app. kg / km	AWG-No.
21011	14 x 2 x 0,14	10,4	74,0	148,0	26	19972	3 x 2 x 0,34	7,2	44,9	78,0	22
21012	15 x 2 x 0,14	10,6	76,0	152,0	26	19973	4 x 2 x 0,34	8,1	54,2	90,0	22
21013	16 x 2 x 0,14	10,7	79,0	155,0	26	19974	5 x 2 x 0,34	9,0	63,5	110,0	22
21014	18 x 2 x 0,14	11,2	83,0	171,0	26	19975	6 x 2 x 0,34	10,0	73,1	130,0	22
21015	20 x 2 x 0,14	11,4	97,0	183,0	26	19976	7 x 2 x 0,34	10,0	79,5	145,0	22
21016	22 x 2 x 0,14	12,3	103,0	205,0	26	19977	8 x 2 x 0,34	10,8	88,4	150,0	22
21017	24 x 2 x 0,14	12,8	111,0	228,0	26	19978	9 x 2 x 0,34	11,1	99,3	170,0	22
21018	25 x 2 x 0,14	12,9	113,0	239,0	26	19979	10 x 2 x 0,34	12,2	106,9	190,0	22
21019	26 x 2 x 0,14	13,0	122,0	245,0	26	19980	12 x 2 x 0,34	12,9	122,1	220,0	22
21020	27 x 2 x 0,14	13,1	125,0	251,0	26	19981	14 x 2 x 0,34	13,9	138,2	245,0	22
21021	28 x 2 x 0,14	14,0	128,0	258,0	26	19982	16 x 2 x 0,34	14,5	154,2	250,0	22
21022	30 x 2 x 0,14	14,1	140,0	270,0	26	19983	18 x 2 x 0,34	15,3	197,9	275,0	22
21023	32 x 2 x 0,14	14,8	145,0	284,0	26	19984	21 x 2 x 0,34	16,3	214,4	300,0	22
21024	34 x 2 x 0,14	14,9	150,0	300,0	26	19985	25 x 2 x 0,34	17,6	238,5	400,0	22
21025	36 x 2 x 0,14	15,6	156,0	316,0	26	19986	27 x 2 x 0,34	18,0	262,5	410,0	22
21026	38 x 2 x 0,14	16,4	162,0	350,0	26	19987	30 x 2 x 0,34	19,5	286,6	440,0	22
21027	40 x 2 x 0,14	16,8	177,0	370,0	26	19988	34 x 2 x 0,34	20,8	310,1	510,0	22
21028	44 x 2 x 0,14	17,0	181,0	390,0	26	19989	37 x 2 x 0,34	21,4	368,7	550,0	22
21029	46 x 2 x 0,14	17,2	195,0	430,0	26	19990	40 x 2 x 0,34	22,1	392,6	590,0	22
21030	50 x 2 x 0,14	18,0	202,0	440,0	26	19991	44 x 2 x 0,34	23,0	424,3	600,0	22
21031	52 x 2 x 0,14	18,2	206,0	460,0	26	19992	50 x 2 x 0,34	24,5	455,9	650,0	22
21032	55 x 2 x 0,14	18,7	210,0	480,0	26	19993	52 x 2 x 0,34	24,7	487,6	680,0	22
21033	1 x 2 x 0,25	4,4	15,0	45,0	24	19994	56 x 2 x 0,34	26,1	518,5	750,0	22
21034	2 x 2 x 0,25	5,8	28,0	53,0	24	19995	61 x 2 x 0,34	27,5	557,2	840,0	22
21035	3 x 2 x 0,25	6,4	32,0	65,0	24	17047	1 x 2 x 0,5	5,3	24,0	60,0	20
21036	4 x 2 x 0,25	7,2	38,0	80,0	24	17001	2 x 2 x 0,5	7,6	54,0	89,0	20
21037	5 x 2 x 0,25	8,1	55,0	98,0	24	17002	3 x 2 x 0,5	8,2	70,0	104,0	20
21038	6 x 2 x 0,25	8,8	65,0	114,0	24	17003	4 x 2 x 0,5	9,0	91,0	126,0	20
21039	7 x 2 x 0,25	8,8	70,0	121,0	24	17004	5 x 2 x 0,5	9,9	105,0	148,0	20
21040	8 x 2 x 0,25	9,4	75,0	129,0	24	17005	6 x 2 x 0,5	10,9	120,0	171,0	20
21041	10 x 2 x 0,25	10,8	110,0	157,0	24	17006	8 x 2 x 0,5	12,0	144,0	290,0	20
21042	12 x 2 x 0,25	11,4	117,0	189,0	24	17007	10 x 2 x 0,5	13,8	178,0	320,0	20
21043	14 x 2 x 0,25	12,0	122,0	213,0	24	17008	12 x 2 x 0,5	14,5	199,0	361,0	20
21044	15 x 2 x 0,25	12,5	134,0	225,0	24	17009	16 x 2 x 0,5	16,1	254,0	421,0	20
21045	16 x 2 x 0,25	12,6	143,0	237,0	24	17010	20 x 2 x 0,5	18,4	302,0	580,0	20
21046	18 x 2 x 0,25	13,3	148,0	248,0	24	17011	25 x 2 x 0,5	21,0	344,0	740,0	20
21047	20 x 2 x 0,25	14,0	162,0	275,0	24	17048	1 x 2 x 0,75	6,0	28,0	71,0	19
21048	22 x 2 x 0,25	15,0	172,0	303,0	24	17012	2 x 2 x 0,75	8,7	58,0	105,0	19
21049	24 x 2 x 0,25	15,7	223,0	330,0	24	17013	3 x 2 x 0,75	9,3	84,0	128,0	19
21050	25 x 2 x 0,25	15,8	233,0	343,0	24	17014	4 x 2 x 0,75	10,6	108,0	156,0	19
21051	26 x 2 x 0,25	15,9	238,0	345,0	24	17015	5 x 2 x 0,75	11,7	126,0	189,0	19
21052	27 x 2 x 0,25	16,0	244,0	350,0	24	17016	6 x 2 x 0,75	12,7	146,0	216,0	19
21053	28 x 2 x 0,25	16,6	249,0	360,0	24	17017	8 x 2 x 0,75	14,4	180,0	309,0	19
21054	30 x 2 x 0,25	17,0	254,0	375,0	24	17018	10 x 2 x 0,75	15,6	220,0	355,0	19
21055	32 x 2 x 0,25	17,6	290,0	400,0	24	17019	12 x 2 x 0,75	16,8	261,0	405,0	19
21056	34 x 2 x 0,25	17,9	312,0	410,0	24	17020	16 x 2 x 0,75	18,7	328,0	565,0	19
21057	36 x 2 x 0,25	18,6	322,0	420,0	24	17021	20 x 2 x 0,75	20,9	392,0	700,0	19
21058	38 x 2 x 0,25	19,0	339,0	450,0	24	17022	25 x 2 x 0,75	23,2	470,0	950,0	19
21059	40 x 2 x 0,25	19,7	349,0	485,0	24	17049	1 x 2 x 1	6,3	46,0	75,0	18
21060	44 x 2 x 0,25	20,7	359,0	500,0	24	17050	2 x 2 x 1	9,1	82,0	116,0	18
21061	46 x 2 x 0,25	21,2	398,0	540,0	24	17051	3 x 2 x 1	9,8	103,0	140,0	18
21062	50 x 2 x 0,25	22,0	403,0	550,0	24	17052	4 x 2 x 1	10,9	132,0	191,0	18
21063	52 x 2 x 0,25	22,0	435,0	580,0	24	17053	1 x 2 x 1,5	7,2	63,0	84,0	16
21064	55 x 2 x 0,25	22,5	464,0	630,0	24	17054	2 x 2 x 1,5	10,7	111,0	122,0	16
19970	1 x 2 x 0,34	5,0	16,0	58,0	22	17055	3 x 2 x 1,5	11,4	136,0	194,0	16
19971	2 x 2 x 0,34	6,7	36,9	65,0	22	17056	4 x 2 x 1,5	12,8	172,0	240,0	16

Dimensions and specifications may be changed without prior notice. (RB01)



Technical data

- Halogen-free special data cable
- **Temperature range**
flexing +5°C to +70°C
fixed installation -40°C to +70°C
- **Operating peak voltage**
(not for heavy current installation purposes)
0,14 mm² = 350 V
≥ 0,25 mm² = 500 V
- **Test voltage**
0,14 mm² = 800 V
≥ 0,25 mm² = 1200 V
- **Insulation resistance**
min. 2 GOhm x km
- **Capacitance**
core/core < 70 nF/km
- **Minimum bending radius**
flexing 7,5x cable Ø
fixed installation 4x cable Ø
- **Radiation resistance**
up to 100x10⁶ cJ/kg (up to 100 Mrad)

Cable structure

- Bare copper conductor, fine wire to DIN VDE 0812
- Conductor construction:
0,34 mm² = 7x0,25 mm
- Core insulation of PE compound type LD/MD to DIN VDE 0819-103 / DIN EN 50290-2-23
- Core identification to DIN 47100, without colour repetition
- Cores stranded in layers with optimal lay length
- Outer sheath compound type HM2 to DIN VDE 0207 part 24
- Sheath colour: grey (RAL 7005)
- With meter marking

Properties

- PE-insulated cores, compared with PVC-insulated cores, assure a remarkable and more favourable capacitance values

Tests

- Halogen-free acc. to DIN VDE 0482-754-1, DIN EN 60754-1, IEC 60754-1 (previously DIN VDE 0482-267-2-1)
- Corrosiveness of combustion gases acc. to DIN VDE 0482-754-2, DIN EN 60754-2, IEC 60754-2 (previously DIN VDE 0482-267-2-2)
- Halogen-free sheath compound, self-extinguishing and flame retardant acc. to DIN VDE 0482-332-1-2, DIN EN 60332-1-2, IEC 60332-1-2 (equivalent DIN VDE 0472 part 804 test method B)

Note

- AWG sizes are approximate equivalent values. The actual cross section is in mm².
- Screened analogue type: **DATAFLAMM®-C**

Application

DATAFLAMM® halogen-free data cables are used as connecting cable for signal, measuring, control, call-announcing and two-way intercom speaking systems, clock installations, electronic weighing equipment and electrical apparatus for office requirements. The cables are suitable for installation in dry, damp and wet environments. These cables are generally installed in telecommunication apparatus and data transmission systems in public buildings, laboratories, trading centres where the freedom from halogen in case of fire and the flame propagation must be avoided. The halogen-free thermoplastic sheath produce neither corrosive nor toxic gases.

☑️ = Product conforms with Low-Voltage Directive 2014/35/EU.

Part no.	No. cores x cross-sec. mm ²	Outer Ø app. mm	Cop. weight kg / km	Weight app. kg / km	AWG-No.
52300	2 x 0,14	3,3	2,6	14,0	26
52301	3 x 0,14	3,5	4,0	17,0	26
52302	4 x 0,14	3,7	5,3	19,0	26
52303	5 x 0,14	4,0	6,6	23,0	26
52304	6 x 0,14	4,3	7,9	25,0	26
52305	7 x 0,14	4,3	9,2	27,0	26
52306	8 x 0,14	4,6	10,3	30,0	26
52307	10 x 0,14	5,4	13,2	38,0	26
52308	12 x 0,14	5,7	16,0	45,0	26
52309	15 x 0,14	6,1	20,1	57,0	26
52310	18 x 0,14	6,7	23,7	65,0	26
52311	21 x 0,14	7,0	27,9	76,0	26
52312	25 x 0,14	7,8	33,4	88,0	26
52313	30 x 0,14	8,2	39,3	98,0	26
52314	34 x 0,14	8,8	45,5	111,0	26
52315	40 x 0,14	9,5	53,6	139,0	26
52316	50 x 0,14	10,5	64,9	164,0	26
52317	2 x 0,25	3,8	4,7	18,0	24
52318	3 x 0,25	4,0	7,1	21,0	24
52319	4 x 0,25	4,3	9,5	26,0	24
52320	5 x 0,25	4,7	12,0	31,0	24
52321	7 x 0,25	5,1	16,6	40,0	24
52322	10 x 0,25	6,4	24,0	56,0	24
52323	12 x 0,25	6,6	28,6	64,0	24
52324	15 x 0,25	7,4	36,0	80,0	24
52430	18 x 0,25	7,9	43,2	90,0	24
52431	21 x 0,25	8,6	50,4	105,0	24
52325	25 x 0,25	9,4	59,8	121,0	24
52326	34 x 0,25	11,0	81,3	168,0	24
52327	40 x 0,25	12,0	96,0	196,0	24
52328	2 x 0,34	4,4	6,4	25,0	22
52329	3 x 0,34	4,7	9,7	30,0	22

Part no.	No. cores x cross-sec. mm ²	Outer Ø app. mm	Cop. weight kg / km	Weight app. kg / km	AWG-No.
52330	4 x 0,34	5,0	13,0	35,0	22
52331	5 x 0,34	5,5	16,4	43,0	22
52332	7 x 0,34	6,0	22,7	58,0	22
52333	10 x 0,34	7,8	32,4	80,0	22
52334	12 x 0,34	8,0	39,1	91,0	22
52335	15 x 0,34	9,0	49,1	115,0	22
52336	18 x 0,34	9,8	59,1	135,0	22
52337	21 x 0,34	10,4	68,3	154,0	22
52338	25 x 0,34	12,0	81,4	180,0	22
52339	34 x 0,34	13,6	111,1	233,0	22
52340	40 x 0,34	14,8	130,5	272,0	22
52341	2 x 0,5	4,6	9,5	30,0	20
52342	3 x 0,5	4,9	14,2	36,0	20
52343	4 x 0,5	5,3	19,2	43,0	20
52344	5 x 0,5	5,9	24,0	56,0	20
52345	7 x 0,5	6,4	33,7	70,0	20
52346	10 x 0,5	8,3	48,0	101,0	20
52347	12 x 0,5	8,6	57,4	117,0	20
52348	15 x 0,5	9,8	72,0	145,0	20
52349	18 x 0,5	10,5	86,4	171,0	20
52350	21 x 0,5	11,1	101,0	197,0	20
52351	25 x 0,5	12,6	120,0	230,0	20
52352	30 x 0,5	13,3	142,6	269,0	20
52353	34 x 0,5	14,5	163,1	301,0	20
52354	40 x 0,5	15,8	192,0	365,0	20
52355	2 x 0,75	5,2	14,3	40,0	19
52356	3 x 0,75	5,5	21,5	51,0	19
52357	4 x 0,75	6,0	28,6	61,0	19
52358	5 x 0,75	6,7	36,1	76,0	19
52359	7 x 0,75	7,3	50,3	97,0	19
52360	10 x 0,75	9,8	72,0	137,0	19
52361	12 x 0,75	10,0	86,2	167,0	19

Dimensions and specifications may be changed without prior notice. (RB01)

DATAFLAMM® -C

EMC-preferred type, halogen-free, screened, meter marking



Technical data

- Halogen-free special data cable
- **Temperature range**
flexing +5°C to +70°C
fixed installation -40°C to +70°C
- **Operating peak voltage**
(not for heavy current installation purposes)
0,14 mm² = 350 V
≥ 0,25 mm² = 500 V
- **Test voltage**
0,14 mm² = 800 V
≥ 0,25 mm² = 1200 V
- **Insulation resistance**
min. 2 GOhm x km
- **Capacitance**
core/core < 70 nF/km
- **Minimum bending radius**
flexing 7,5x cable Ø
fixed installation 4x cable Ø
- **Coupling resistance**
max. 250 Ohm/km
- **Radiation resistance**
up to 100x10⁶ cJ/kg (up to 100 Mrad)

Cable structure

- Bare copper conductor, to DIN VDE 0812, fine wire
- Conductor construction:
0,34 mm² = 7x0,25 mm
- Core insulation of PE compound type LD/MD to DIN VDE 0819-103 / DIN EN 50290-2-23
- Core identification to DIN 47100
- Cores stranded in layers with optimal lay length
- Foil wrapping
- Tinned copper braided screen, approx. 85% coverage
- Outer sheath compound type HM2 to DIN VDE 0207 part 24
- Sheath colour: grey (RAL 7005)
- With meter marking

Properties

- PE-insulated cores, compared with PVC-insulated cores, assure a remarkable and more favourable capacitance values

Tests

- Halogen-free acc. to DIN VDE 0482-754-1, DIN EN 60754-1, IEC 60754-1 (previously DIN VDE 0482-267-2-1)
- Corrosiveness of combustion gases acc. to DIN VDE 0482-754-2, DIN EN 60754-2, IEC 60754-2 (previously DIN VDE 0482-267-2-2)
- Halogen-free sheath compound, self-extinguishing and flame retardant acc. to DIN VDE 0482-332-1-2, DIN EN 60332-1-2, IEC 60332-1-2

Note

- AWG sizes are approximate equivalent values. The actual cross section is in mm².
- Unscreened analogue type: **DATAFLAMM®**

Application

As a connecting and interconnecting cable for signaling, measuring, control and intercom purposes for the use in paging and intercom systems, clock systems, weighing equipment and office machines. The cables can be laid on or under plaster, in dry, damp and wet rooms as well as masonry and concrete. Areas of use are telecommunications and information processing systems in public buildings, laboratories, warehouses and other buildings in which the release of halogens in the event of fire must be avoided. Due to the screening without interference against foreign encoder or high-frequency signals.

EMC = Electromagnetic compatibility

To optimize the EMC features we recommend a large round contact of the copper braiding on both ends.

CE = Product conforms with Low-Voltage Directive 2014/35/EU.

Part no.	No. cores x cross-sec. mm ²	Outer Ø app. mm	Cop. weight kg / km	Weight app. kg / km	AWG-No.
52365	2 x 0,14	3,7	12,4	21,0	26
52366	3 x 0,14	3,9	14,0	25,0	26
52367	4 x 0,14	4,1	15,8	26,0	26
52368	5 x 0,14	4,4	19,5	32,0	26
52369	7 x 0,14	4,7	23,4	39,0	26
52370	10 x 0,14	5,9	28,4	54,0	26
52371	12 x 0,14	6,0	31,4	69,0	26
52372	14 x 0,14	6,4	37,5	76,0	26
52373	16 x 0,14	6,7	43,4	82,0	26
52374	18 x 0,14	7,0	51,4	90,0	26
52375	21 x 0,14	7,4	61,8	102,0	26
52376	25 x 0,14	8,3	76,0	121,0	26
52377	30 x 0,14	8,6	92,7	146,0	26
52378	34 x 0,14	9,4	121,0	167,0	26
52379	40 x 0,14	10,2	126,1	170,0	26
52380	2 x 0,25	4,3	14,6	23,0	24
52381	3 x 0,25	4,5	17,0	28,0	24
52382	4 x 0,25	4,8	20,6	34,0	24
52384	5 x 0,25	5,2	24,7	42,0	24
52385	7 x 0,25	5,6	31,2	49,0	24
52386	10 x 0,25	7,2	42,1	81,0	24
52387	12 x 0,25	7,3	47,5	88,0	24
52388	14 x 0,25	7,9	52,7	100,0	24
52389	16 x 0,25	8,3	58,1	113,0	24
52390	18 x 0,25	9,1	78,0	126,0	24
52391	21 x 0,25	9,5	94,3	144,0	24
52392	25 x 0,25	10,6	116,5	164,0	24
52393	30 x 0,25	11,1	132,2	191,0	24
52394	34 x 0,25	11,9	144,6	214,0	24
52395	40 x 0,25	13,0	163,3	245,0	24
52396	2 x 0,34	4,8	16,9	31,0	22
52397	3 x 0,34	5,1	20,6	38,0	22

Part no.	No. cores x cross-sec. mm ²	Outer Ø app. mm	Cop. weight kg / km	Weight app. kg / km	AWG-No.
52398	4 x 0,34	5,5	24,5	47,0	22
52399	5 x 0,34	6,0	30,0	58,0	22
52400	7 x 0,34	6,4	38,2	76,0	22
52401	10 x 0,34	8,0	62,2	110,0	22
52402	12 x 0,34	8,5	69,4	123,0	22
52403	14 x 0,34	9,0	82,1	140,0	22
52404	16 x 0,34	9,5	95,0	157,0	22
52405	18 x 0,34	10,2	107,3	172,0	22
52406	21 x 0,34	10,8	122,4	195,0	22
52407	25 x 0,34	12,2	142,2	226,0	22
52408	30 x 0,34	12,7	162,6	261,0	22
52409	34 x 0,34	13,7	178,9	285,0	22
52410	40 x 0,34	14,9	203,3	330,0	22
52411	2 x 0,5	5,1	23,0	37,0	20
52412	3 x 0,5	5,5	30,0	46,0	20
52413	4 x 0,5	5,9	35,3	57,0	20
52414	5 x 0,5	6,6	52,5	77,0	20
52415	7 x 0,5	7,1	65,3	92,0	20
52416	10 x 0,5	9,3	88,7	135,0	20
52417	12 x 0,5	9,4	98,7	148,0	20
52418	18 x 0,5	11,1	141,2	210,0	20
52419	21 x 0,5	12,0	161,0	242,0	20
52420	25 x 0,5	13,5	187,2	285,0	20
52421	30 x 0,5	14,2	223,2	340,0	20
52422	40 x 0,5	16,5	294,9	445,0	20
52423	2 x 0,75	5,9	30,6	45,0	19
52424	3 x 0,75	6,2	38,1	60,0	19
52425	4 x 0,75	6,9	58,0	80,0	19
52426	5 x 0,75	7,5	68,4	97,0	19
52427	7 x 0,75	8,1	88,4	127,0	19
52428	10 x 0,75	10,4	122,5	175,0	19
52429	12 x 0,75	10,9	137,2	196,0	19

Dimensions and specifications may be changed without prior notice. (RB01)

DATAFLAMM® -C-PAAR

EMC-preferred type, halogen-free, screened, meter marking



Technical data

- Halogen-free special data cable
- **Temperature range**
flexing +5°C to +70°C
fixed installation -40°C to +70°C
- **Operating peak voltage**
(not for heavy current installation purposes)
0,14 mm² = 350 V
≥ 0,25 mm² = 500 V
- **Test voltage**
0,14 mm² = 800 V
≥ 0,25 mm² = 1200 V
- **Insulation resistance**
min. 2 GOhm x km
- **Capacitance**
core/core < 70 nF/km
- **Minimum bending radius**
flexing 7,5x cable Ø
fixed installation 4x cable Ø
- **Coupling resistance**
max. 250 Ohm/km
- **Radiation resistance**
up to 100x10⁶ cJ/kg (up to 100 Mrad)

Cable structure

- Bare copper conductor, fine wire to DIN VDE 0812
- Conductor construction:
0,34 mm² = 7x0,25 mm
- Core insulation of PE compound type LD/MD to DIN VDE 0819-103 / DIN EN 50290-2-23
- Core identification to DIN 47100
- Cores stranded in pairs with optimal lay length
- Pairs stranded in layers with optimal lay length
- Foil wrapping
- Tinned copper braided screen, approx. 85% coverage
- Outer sheath compound type HM2 to DIN VDE 0207 part 24
- Sheath colour: grey (RAL 7005)
- With meter marking

Properties

- PE-insulated cores, compared with PVC-insulated cores, assure a remarkable and more favourable capacitance values

Tests

- Halogen-free acc. to DIN VDE 0482-754-1, DIN EN 60754-1, IEC 60754-1 (previously DIN VDE 0482-267-2-1)
- Corrosiveness of combustion gases acc. to DIN VDE 0482-754-2, DIN EN 60754-2, IEC 60754-2 (previously DIN VDE 0482-267-2-2)
- Halogen-free sheath compound, self-extinguishing and flame retardant acc. to DIN VDE 0482-332-1-2, DIN EN 60332-1-2, IEC 60332-1-2 (equivalent DIN VDE 0472 part 804 test method B)

Note

- AWG sizes are approximate equivalent values. The actual cross section is in mm².

Application

Are used as connecting cable for signal, measuring, control, call-announcing and two-way intercom speaking systems, clock installations, electronic weighing equipment and electrical apparatus for office requirements. The cables are suitable for installation in dry, damp and wet environments as well as in masonry and concrete. These cables are generally installed in telecommunication apparatus and data transmission systems in public buildings, laboratories, trading centres where the freedom from halogen in case of fire and the flame propagation must be avoided. With screened braiding offers interference-free signal transfer. The halogen-free thermoplastic sheath produce neither corrosive nor toxic gases.

EMC = Electromagnetic compatibility

To optimize the EMC features we recommend a large round contact of the copper braiding on both ends.

= Product conforms with Low-Voltage Directive 2014/35/EU.

Part no.	No. pairs x cross-sec. mm ²	Outer Ø app. mm	Cop. weight kg / km	Weight app. kg / km	AWG-No.
52435	2 x 2 x 0,14	4,7	22,5	37,0	26
52436	3 x 2 x 0,14	5,1	25,6	47,0	26
52437	4 x 2 x 0,14	5,8	39,1	66,0	26
52438	5 x 2 x 0,14	6,3	45,3	76,0	26
52439	6 x 2 x 0,14	6,8	51,4	87,0	26
52440	7 x 2 x 0,14	6,8	54,2	94,0	26
52441	10 x 2 x 0,14	8,9	68,7	119,0	26
52442	12 x 2 x 0,14	9,2	78,3	135,0	26
52443	15 x 2 x 0,14	10,0	79,9	157,0	26
52444	18 x 2 x 0,14	11,0	99,2	190,0	26
52445	2 x 2 x 0,25	5,7	27,1	44,0	24
52446	3 x 2 x 0,25	6,2	42,4	66,0	24
52447	4 x 2 x 0,25	7,0	54,5	81,0	24
52448	5 x 2 x 0,25	7,9	59,8	98,0	24
52449	6 x 2 x 0,25	8,6	64,6	116,0	24
52450	7 x 2 x 0,25	8,6	71,3	120,0	24
52451	10 x 2 x 0,25	10,6	93,3	153,0	24
52452	12 x 2 x 0,25	11,4	108,0	175,0	24
52453	15 x 2 x 0,25	12,5	123,4	213,0	24
52454	18 x 2 x 0,25	13,1	139,7	248,0	24
52455	2 x 2 x 0,34	6,5	43,3	68,0	22
52456	3 x 2 x 0,34	7,2	55,0	92,0	22
52457	4 x 2 x 0,34	7,9	64,0	110,0	22
52458	5 x 2 x 0,34	8,8	74,5	128,0	22
52459	6 x 2 x 0,34	9,8	85,0	147,0	22

Part no.	No. pairs x cross-sec. mm ²	Outer Ø app. mm	Cop. weight kg / km	Weight app. kg / km	AWG-No.
52460	7 x 2 x 0,34	9,8	89,8	154,0	22
52461	10 x 2 x 0,34	12,2	119,8	209,0	22
52462	12 x 2 x 0,34	12,9	139,4	245,0	22
52463	15 x 2 x 0,34	14,4	160,0	279,0	22
52464	18 x 2 x 0,34	15,3	207,2	363,0	22
52465	2 x 2 x 0,5	7,4	50,2	76,0	20
52466	3 x 2 x 0,5	8,0	64,5	107,0	20
52467	4 x 2 x 0,5	9,0	77,2	134,0	20
52468	5 x 2 x 0,5	9,9	96,2	150,0	20
52469	6 x 2 x 0,5	10,9	107,4	176,0	20
52470	7 x 2 x 0,5	10,9	117,3	185,0	20
52471	10 x 2 x 0,5	13,8	158,2	275,0	20
52472	12 x 2 x 0,5	14,5	177,8	330,0	20
52473	15 x 2 x 0,5	15,8	236,4	380,0	20
52474	18 x 2 x 0,5	17,1	265,4	450,0	20
52475	2 x 2 x 0,75	8,5	64,6	105,0	19
52476	3 x 2 x 0,75	9,3	81,7	137,0	19
52477	4 x 2 x 0,75	10,6	107,6	166,0	19
52478	5 x 2 x 0,75	11,7	126,1	200,0	19
52479	6 x 2 x 0,75	12,7	138,6	236,0	19
52480	7 x 2 x 0,75	12,7	153,7	255,0	19
52481	10 x 2 x 0,75	15,6	220,0	363,0	19
52482	12 x 2 x 0,75	16,8	265,5	434,0	19
52483	15 x 2 x 0,75	18,6	327,6	500,0	19
52484	18 x 2 x 0,75	20,5	374,6	580,0	19

Dimensions and specifications may be changed without prior notice. (RB01)

Command Cable UL (LiYY)

Style 2464, 300 V, 80°C



Technical data

- Special PVC command cable, approved to UL Style 2464, cores for AWG 26-20 to UL Style 1061/1729 for AWG 18-16 to UL Style 1007/1569
- **Temperature range**
flexing -10°C to +80°C
fixed installation -20°C to +80°C
- **Nominal voltage**
300 V
- **Test voltage**
1500 V
- **Breakdown voltage**
min. 3000 V
- **Minimum bending radius**
flexing 15x cable Ø
fixed installation 7,5x cable Ø

Cable structure

- Tinned copper conductor, fine wire, AWG 26-20 to ASTM-B 174-95 class J-M, AWG 18-16 to ASTM-B 286
Conductor make-up to:
0,14 mm² = 7x0,162 mm
0,23 mm² = 7x0,202 mm
0,34 mm² = 7x0,254 mm
0,56 mm² = 7x0,32 mm
0,82 mm² = 19x0,235 mm
1,30 mm² = 19x0,31 mm
- Core insulation of special PVC class 43 respectively semirigid acc. to UL Std.1581 tab.50.182 and 50.183
- Core identification to DIN 47100 or international colour code
- Cores stranded in layers with optimal lay length
- Outer sheath of special PVC class 43 acc. to UL Std.1581 tab.50.182
- Sheath colour:
black (international colour code)
grey (DIN 47100 - preferred type)

Properties

- The materials used during manufacturing are cadmium-free, contain no silicone and are free from substances harmful to the wetting properties of lacquers
- **To a large extent resistant to**
Oil
Solvents
Acids
Lyes
- **Tests**
PVC flame retardant acc. to UL VW-1, CSA FT1

Note

- AWG sizes are approximate equivalent values. The actual cross section is in mm².
- Screened analogue type:
command cable UL (LiYCY)

Application

As a flexible connector and connecting cable, as control, signal and measuring line of machine tools, conveyor belts and plant construction, air conditioning systems, in foundries and steel mills.

CE = Product conforms with Low-Voltage Directive 2014/35/EU.

Part no. Sheath colour grey	Part no. Sheath colour black	No.cores x cross-sec. mm ²	AWGNo.	Outer Ø app. mm	Cop. weight kg / km	Weight app. kg / km	Part no. Sheath colour grey	Part no. Sheath colour black	No.cores x cross-sec. mm ²	AWGNo.	Outer Ø app. mm	Cop. weight kg / km	Weight app. kg / km
83137	83045	2 x 0,14	26	3,6	3,6	13,0	83185	83386	2 x 0,56	20	4,6	9,8	30,0
83138	83046	3 x 0,14	26	3,8	4,0	15,0	83186	83387	3 x 0,56	20	4,8	14,6	33,0
83139	83047	4 x 0,14	26	4,0	5,4	18,0	83187	83388	4 x 0,56	20	5,2	19,4	41,0
83140	83048	6 x 0,14	26	4,6	8,1	25,0	83188	83389	6 x 0,56	20	6,1	29,0	65,0
83141	83049	10 x 0,14	26	5,6	13,4	38,0	83189	83390	10 x 0,56	20	7,6	48,2	102,0
83142	83050	12 x 0,14	26	5,8	16,2	46,0	83190	83391	12 x 0,56	20	7,8	58,2	120,0
83143	83055	16 x 0,14	26	6,3	21,5	56,0	83191	83392	16 x 0,56	20	8,7	77,3	152,0
83144	83056	18 x 0,14	26	6,6	34,4	62,0	83192	83393	18 x 0,56	20	9,3	87,0	168,0
83145	83057	24 x 0,14	26	7,5	32,4	82,0	83193	83394	24 x 0,56	20	10,9	116,3	224,0
83146	83058	27 x 0,14	26	7,6	36,3	97,0	83194	83395	27 x 0,56	20	11,2	129,8	260,0
83147	83059	30 x 0,14	26	8,0	40,4	110,0	83195	83396	30 x 0,56	20	11,8	144,6	300,0
83153	83130	2 x 0,23	24	3,8	4,6	16,0	83201	83397	2 x 0,82	18	6,1	15,2	50,0
83154	83131	3 x 0,23	24	4,0	7,1	19,0	83202	83398	3 x 0,82	18	6,4	23,2	62,0
83155	83132	4 x 0,23	24	4,3	9,4	23,0	83203	83399	4 x 0,82	18	6,9	31,3	72,0
83156	83133	6 x 0,23	24	4,9	14,2	32,0	83204	83474	6 x 0,82	18	8,1	47,0	100,0
83157	83134	10 x 0,23	24	6,0	23,8	55,0	83205	83475	10 x 0,82	18	10,4	78,2	180,0
83158	83135	12 x 0,23	24	6,2	28,5	60,0	83206	83476	12 x 0,82	18	10,9	94,0	182,0
83159	83136	16 x 0,23	24	6,8	38,1	75,0	83207	83477	16 x 0,82	18	12,2	125,1	240,0
83160	83371	18 x 0,23	24	7,1	43,1	82,0	83208	83478	18 x 0,82	18	13,0	141,1	270,0
83161	83372	24 x 0,23	24	8,1	59,7	116,0	83209	83479	24 x 0,82	18	15,2	188,2	370,0
83162	83373	27 x 0,23	24	8,4	64,7	140,0	83210	83480	27 x 0,82	18	15,8	212,0	400,0
83163	83374	30 x 0,23	24	8,9	71,9	150,0	83211	83481	30 x 0,82	18	16,3	235,6	470,0
83169	83375	2 x 0,34	22	4,1	6,5	25,0	83217	83482	2 x 1,3	16	6,6	24,4	70,0
83170	83376	3 x 0,34	22	4,3	9,8	30,0	83218	83483	3 x 1,3	16	7,0	37,1	90,0
83171	83377	4 x 0,34	22	4,6	13,0	45,0	83219	83484	4 x 1,3	16	7,6	49,4	110,0
83172	83378	6 x 0,34	22	5,4	19,6	60,0	83220	83491	6 x 1,3	16	9,2	74,2	160,0
83173	83379	10 x 0,34	22	6,6	32,5	80,0	83221	83492	10 x 1,3	16	11,8	124,0	250,0
83174	83380	12 x 0,34	22	6,8	39,1	105,0	83222	83493	12 x 1,3	16	12,2	149,0	300,0
83175	83381	16 x 0,34	22	7,5	52,0	130,0	83223	83494	16 x 1,3	16	13,7	198,7	400,0
83176	83382	18 x 0,34	22	8,1	59,0	140,0	83224	83495	18 x 1,3	16	14,6	224,0	450,0
83177	83383	24 x 0,34	22	9,4	79,0	190,0	83225	83496	24 x 1,3	16	17,0	298,4	650,0
83178	83384	27 x 0,34	22	9,7	88,0	207,0	83226	83497	27 x 1,3	16	17,6	336,0	680,0
83179	83385	30 x 0,34	22	10,2	97,8	225,0	83227	83498	30 x 1,3	16	18,6	373,6	750,0

Dimensions and specifications may be changed without prior notice. (RN02)

Command Cable UL (LiYCY)

Style 2464, 300 V, 80°C, EMC-preferred type



Technical data

- Special PVC command cable, approved to UL Style 2464, cores for AWG 26-20 to UL Style 1061/1729 for AWG 18-16 to UL Style 1007/1569
- **Temperature range**
flexing -10°C to +80°C
fixed installation -20°C to +80°C
- **Nominal voltage**
300 V
- **Test voltage**
1500 V
- **Breakdown voltage**
min. 3000 V
- **Minimum bending radius**
flexing 15x cable Ø
fixed installation 7,5x cable Ø
- **Coupling resistance**
max. 250 Ohm/km

Cable structure

- Tinned copper conductor, fine wire, AWG 26-20 to ASTM-B 174-95 class J-M, AWG 18-16 to ASTM-B 286
Conductor make-up to:
0,14 mm² = 7x0,162 mm
0,23 mm² = 7x0,202 mm
0,34 mm² = 7x0,254 mm
0,56 mm² = 7x0,32 mm
0,82 mm² = 19x0,235 mm
1,30 mm² = 19x0,31 mm
- Core insulation of special PVC class 43 respectively semirigid acc. to UL Std. 1581 tab.50.182 and 50.183
- Colour coded to DIN 47100 or international colour code
- Cores stranded in layers with optimal lay length
- Separator-foil
- Drain wire
- Tinned copper wire braiding, approx. 85% coverage
- Outer sheath of PVC class 43 acc. to UL Std. 1581 tab.50.182
- Sheath colour:
black (international colour code)
grey (DIN 47100 - preferred type)

Properties

- The materials used during manufacturing are cadmium-free, contain no silicone and are free from substances harmful to the wetting properties of lacquers
- **To a large extent resistant to**
Oil
Solvents
Acids
Lyes

Tests

- PVC flame retardant acc. to UL VW-1, CSA FT1

Note

- AWG sizes are approximate equivalent values. The actual cross section is in mm².
- Unscreened analogue types:
command cable UL (LiYY)

Application

As a flexible interconnecting cable for electronics, control and command technology, as well as in measurement, signal, and pulse technology. Fast and inexpensive contacting by cutting and clamping technology.

EMC = Electromagnetic compatibility

To optimize the EMC features we recommend a large round contact of the copper braiding on both ends.

CE = Product conforms with Low-Voltage Directive 2014/35/EU.

Part no. Sheath colour grey	Part no. Sheath colour black	No. cores x cross-sec. mm ²	AWG-No.	Outer Ø app. mm	Cop. weight kg / km	Weight app. kg / km
83254	83976	2 x 0,14	26	3,9	12,6	20,0
83255	83977	3 x 0,14	26	4,2	13,7	25,0
83256	83978	4 x 0,14	26	4,4	14,9	28,0
83257	83979	6 x 0,14	26	5,0	18,9	30,0
83258	83980	10 x 0,14	26	6,1	29,5	50,0
83259	83981	12 x 0,14	26	6,3	31,4	53,0
83260	83982	16 x 0,14	26	6,8	43,9	60,0
83261	83983	18 x 0,14	26	7,1	52,1	70,0
83262	83984	24 x 0,14	26	8,0	62,8	100,0
83263	83985	27 x 0,14	26	8,4	66,3	105,0
83264	83986	30 x 0,14	26	8,6	70,4	110,0

Part no. Sheath colour grey	Part no. Sheath colour black	No. cores x cross-sec. mm ²	AWG-No.	Outer Ø app. mm	Cop. weight kg / km	Weight app. kg / km
83270	83987	2 x 0,23	24	4,3	16,1	20,0
83271	83988	3 x 0,23	24	4,5	18,9	25,0
83272	83989	4 x 0,23	24	4,8	23,0	30,0
83273	83990	6 x 0,23	24	5,4	32,8	40,0
83274	83991	10 x 0,23	24	6,5	50,9	60,0
83275	83992	12 x 0,23	24	6,7	59,1	70,0
83276	83993	16 x 0,23	24	7,4	68,4	90,0
83277	83994	18 x 0,23	24	7,7	79,5	123,0
83278	83995	24 x 0,23	24	8,8	97,3	131,0
83279	83996	27 x 0,23	24	9,0	122,0	160,0
83280	83997	30 x 0,23	24	9,3	132,0	170,0

Continuation ▶

Command Cable UL (LiYCY)

Style 2464, 300 V, 80°C, EMC-preferred type



Part no. Sheath colour grey	Part no. Sheath colour black	No. cores x cross-sec. mm ²	AWG-No.	Outer Ø app. mm	Cop. weight kg / km	Weight app. kg / km
83286	65044	2 x 0,34	22	4,6	18,1	40,0
83287	65045	3 x 0,34	22	4,8	22,2	50,0
83288	65046	4 x 0,34	22	5,1	28,7	60,0
83289	65047	6 x 0,34	22	6,0	45,4	80,0
83290	65048	10 x 0,34	22	7,3	66,1	130,0
83291	65049	12 x 0,34	22	7,5	70,8	140,0
83292	65050	16 x 0,34	22	8,2	88,4	160,0
83293	65051	18 x 0,34	22	8,7	104,1	170,0
83294	65052	24 x 0,34	22	9,9	129,0	220,0
83295	65053	27 x 0,34	22	10,4	138,4	250,0
83296	65054	30 x 0,34	22	10,9	159,0	280,0
83302	65055	2 x 0,56	20	5,1	29,4	50,0
83303	65056	3 x 0,56	20	5,3	39,7	55,0
83304	65057	4 x 0,56	20	5,6	46,1	61,0
83305	65058	6 x 0,56	20	6,6	66,8	90,0
83306	65059	10 x 0,56	20	8,1	93,1	133,0
83307	65060	12 x 0,56	20	8,4	117,4	151,0
83308	65061	16 x 0,56	20	9,5	130,4	190,0
83309	65062	18 x 0,56	20	9,9	151,4	216,0
83310	65063	24 x 0,56	20	11,5	237,0	339,0
83311	65064	27 x 0,56	20	12,0	257,4	374,0
83312	65065	30 x 0,56	20	12,4	297,0	397,0

Part no. Sheath colour grey	Part no. Sheath colour black	No. cores x cross-sec. mm ²	AWG-No.	Outer Ø app. mm	Cop. weight kg / km	Weight app. kg / km
83318	65066	2 x 0,82	18	6,5	39,1	60,0
83319	65067	3 x 0,82	18	6,8	50,0	75,0
83320	65068	4 x 0,82	18	7,4	59,1	90,0
83321	65069	6 x 0,82	18	8,8	89,1	125,0
83322	65070	10 x 0,82	18	10,9	141,4	180,0
83323	65071	12 x 0,82	18	11,2	152,8	220,0
83324	65072	16 x 0,82	18	12,9	184,1	290,0
83325	65073	18 x 0,82	18	13,5	207,2	300,0
83326	65074	24 x 0,82	18	15,6	272,6	450,0
83327	65075	27 x 0,82	18	15,9	289,1	470,0
83328	65076	30 x 0,82	18	16,6	317,4	490,0
83334	65077	2 x 1,3	16	6,9	59,1	90,0
83335	65078	3 x 1,3	16	7,3	74,1	160,0
83336	65079	4 x 1,3	16	7,9	96,4	200,0
83337	65080	6 x 1,3	16	9,6	137,4	290,0
83338	65081	10 x 1,3	16	12,4	191,7	450,0
83339	65082	12 x 1,3	16	12,8	251,7	600,0
83340	65083	16 x 1,3	16	12,8	276,1	650,0
83341	65084	18 x 1,3	16	15,5	364,1	680,0
83342	65085	24 x 1,3	16	18,1	442,4	900,0
83343	65086	27 x 1,3	16	18,7	494,7	990,0
83344	65087	30 x 1,3	16	19,5	521,4	1050,0

Dimensions and specifications may be changed without prior notice. (RN02)

Command Cable UL (LiYY-TP)

Style 2464, 300 V, 80°C



Technical data

- Special PVC command cable approved to UL Style 2464, cores acc. to UL Style 1061/1729
- **Temperature range**
flexing -10°C to +80°C
fixed installation -20°C to +80°C
- **Nominal voltage**
300 V
- **Test voltage**
1500 V
- **Breakdown voltage**
min. 3000 V
- **Insulation resistance**
min. 100 MOhm x km
- **Minimum bending radius**
flexing 15x cable Ø
fixed installation 7,5x cable Ø

Cable structure

- Tinned copper conductor, fine wire, acc. to ASTM-B 174-95 class J-M
Conductor make-up to:
0,14 mm² = 7x0,162 mm
0,23 mm² = 7x0,202 mm
0,34 mm² = 7x0,254 mm
0,56 mm² = 7x0,32 mm
- Core insulation of special PVC class 43 respectively semirigid acc. to UL Std. 1581 tab.50.182 and 50183
- Core identification (pair) to DIN 47100, with colour repetition from pair no. 23 or international colour code
- Cores stranded in pairs with optimal lay length
- Pairs stranded in layers with optimal lay length
- Separator-foil
- Outer sheath of special PVC class 43 acc. to UL Std. 1581 tab.50.182
- Sheath colour:
black (international colour code)
grey (DIN 47100 - preferred type)

Properties

- The materials used during manufacturing are cadmium-free, contain no silicone and are free from substances harmful to the wetting properties of lacquers
- **To a large extent resistant to**
Oil
Solvents
Acids
Lyes

Tests

- PVC flame retardant acc. to UL VW-1, CSA FT1

Note

- AWG sizes are approximate equivalent values. The actual cross section is in mm².
- Screened analogue type:
command cable UL (LiYCY-TP)

Application

Twisted pair control cable for use in tool making machinery conveyor system and production lines, in industrial plants and in air conditioning as well as in the steel producing industries.

CE = Product conforms with Low-Voltage Directive 2014/35/EU.

Part no. Sheath colour	No.pairs x cross-sec. mm ²	AWG-No.	Outer Ø app. mm	Cop. weight kg / km	Weight app. kg / km
83904	1 x 2 x 0,14	26	3,6	2,7	20,0
83905	2 x 2 x 0,14	26	5,1	5,4	24,0
83906	3 x 2 x 0,14	26	5,3	8,1	30,0
83907	4 x 2 x 0,14	26	5,8	10,8	38,0
83908	5 x 2 x 0,14	26	6,2	13,6	44,0
83909	6 x 2 x 0,14	26	6,8	16,2	51,0
83910	7 x 2 x 0,14	26	6,8	19,0	57,0
83911	8 x 2 x 0,14	26	7,3	21,7	64,0
83912	10 x 2 x 0,14	26	7,4	26,7	76,0
83913	12 x 2 x 0,14	26	9,1	32,6	93,0
83914	14 x 2 x 0,14	26	9,8	37,4	103,0
83915	15 x 2 x 0,14	26	10,6	40,7	109,0
83916	16 x 2 x 0,14	26	10,6	43,4	112,0
83917	18 x 2 x 0,14	26	11,1	48,5	119,0
83918	20 x 2 x 0,14	26	11,9	54,2	130,0
83919	22 x 2 x 0,14	26	12,4	59,3	150,0
83920	24 x 2 x 0,14	26	13,1	64,7	169,0
83921	25 x 2 x 0,14	26	13,4	67,2	178,0
83922	1 x 2 x 0,23	24	3,8	4,8	32,0
83923	2 x 2 x 0,23	24	5,3	9,7	36,0
83924	3 x 2 x 0,23	24	5,7	14,7	48,0
83925	4 x 2 x 0,23	24	6,2	19,6	56,0
83926	5 x 2 x 0,23	24	6,6	24,6	71,0
83927	6 x 2 x 0,23	24	7,2	29,3	80,0
83928	7 x 2 x 0,23	24	7,2	34,1	89,0
83929	8 x 2 x 0,23	24	7,8	39,1	98,0
83930	10 x 2 x 0,23	24	9,2	48,9	111,0
83931	12 x 2 x 0,23	24	9,7	59,4	135,0
83932	14 x 2 x 0,23	24	10,2	68,7	160,0

Part no. Sheath colour	No.pairs x cross-sec. mm ²	AWG-No.	Outer Ø app. mm	Cop. weight kg / km	Weight app. kg / km
65214	1 x 2 x 0,14	26	3,6	2,7	20,0
65215	2 x 2 x 0,14	26	5,1	5,4	24,0
65216	3 x 2 x 0,14	26	5,3	8,1	30,0
65217	4 x 2 x 0,14	26	5,8	10,8	38,0
65218	5 x 2 x 0,14	26	6,2	13,6	44,0
65219	6 x 2 x 0,14	26	6,8	16,2	51,0
65220	7 x 2 x 0,14	26	6,8	19,0	57,0
65221	8 x 2 x 0,14	26	7,3	21,7	64,0
65222	10 x 2 x 0,14	26	7,4	26,7	76,0
65223	12 x 2 x 0,14	26	9,1	32,6	93,0
65224	14 x 2 x 0,14	26	9,8	37,4	103,0
65225	15 x 2 x 0,14	26	10,6	40,7	109,0
65226	16 x 2 x 0,14	26	10,6	43,4	112,0
65227	18 x 2 x 0,14	26	11,1	48,5	119,0
65228	20 x 2 x 0,14	26	11,9	54,2	130,0
65229	22 x 2 x 0,14	26	12,4	59,3	150,0
65230	24 x 2 x 0,14	26	13,1	64,7	169,0
65231	25 x 2 x 0,14	26	13,4	67,2	178,0
65232	1 x 2 x 0,23	24	3,8	4,8	32,0
65233	2 x 2 x 0,23	24	5,3	9,7	36,0
65234	3 x 2 x 0,23	24	5,7	14,7	48,0
65235	4 x 2 x 0,23	24	6,2	19,6	56,0
65236	5 x 2 x 0,23	24	6,6	24,6	71,0
65237	6 x 2 x 0,23	24	7,2	29,3	80,0
65238	7 x 2 x 0,23	24	7,2	34,1	89,0
65239	8 x 2 x 0,23	24	7,8	39,1	98,0
65240	10 x 2 x 0,23	24	9,2	48,9	111,0
65241	12 x 2 x 0,23	24	9,7	59,4	135,0
65242	14 x 2 x 0,23	24	10,2	68,7	160,0

Continuation ▶

Command Cable UL (LiYY-TP)

Style 2464, 300 V, 80°C



Part no. Sheath colour	No.pairs x cross-sec. mm ²	AWG-No.	Outer Ø app. mm	Cop. weight kg / km	Weight app. kg / km	Part no. Sheath colour	No.pairs x cross-sec. mm ²	AWG-No.	Outer Ø app. mm	Cop. weight kg / km	Weight app. kg / km
grey						black					
83933	15 x 2 x 0,23	24	10,9	73,7	171,0	65243	15 x 2 x 0,23	24	10,9	73,7	171,0
83934	16 x 2 x 0,23	24	10,9	79,1	185,0	65244	16 x 2 x 0,23	24	10,9	79,1	185,0
83935	18 x 2 x 0,23	24	11,5	88,9	209,0	65245	18 x 2 x 0,23	24	11,5	88,9	209,0
83936	20 x 2 x 0,23	24	12,2	98,4	230,0	65246	20 x 2 x 0,23	24	12,2	98,4	230,0
83937	22 x 2 x 0,23	24	13,0	108,6	248,0	65247	22 x 2 x 0,23	24	13,0	108,6	248,0
83938	24 x 2 x 0,23	24	13,7	117,9	279,0	65248	24 x 2 x 0,23	24	13,7	117,9	279,0
83939	25 x 2 x 0,23	24	14,2	123,5	292,0	65249	25 x 2 x 0,23	24	14,2	123,5	292,0
83940	1 x 2 x 0,34	22	4,2	6,5	38,0	65250	1 x 2 x 0,34	22	4,2	6,5	38,0
83941	2 x 2 x 0,34	22	5,9	13,0	44,0	65251	2 x 2 x 0,34	22	5,9	13,0	44,0
83942	3 x 2 x 0,34	22	6,3	19,5	60,0	65252	3 x 2 x 0,34	22	6,3	19,5	60,0
83943	4 x 2 x 0,34	22	7,0	26,1	79,0	65253	4 x 2 x 0,34	22	7,0	26,1	79,0
83944	5 x 2 x 0,34	22	7,6	32,6	92,0	65254	5 x 2 x 0,34	22	7,6	32,6	92,0
83945	6 x 2 x 0,34	22	8,2	39,2	119,0	65255	6 x 2 x 0,34	22	8,2	39,2	119,0
83946	7 x 2 x 0,34	22	8,2	45,7	128,0	65256	7 x 2 x 0,34	22	8,2	45,7	128,0
83947	8 x 2 x 0,34	22	9,0	52,3	139,0	65257	8 x 2 x 0,34	22	9,0	52,3	139,0
83948	10 x 2 x 0,34	22	10,7	65,3	171,0	65258	10 x 2 x 0,34	22	10,7	65,3	171,0
83949	12 x 2 x 0,34	22	11,3	78,4	194,0	65259	12 x 2 x 0,34	22	11,3	78,4	194,0
83950	14 x 2 x 0,34	22	12,1	91,5	222,0	65260	14 x 2 x 0,34	22	12,1	91,5	222,0
83951	15 x 2 x 0,34	22	12,7	97,8	231,0	65261	15 x 2 x 0,34	22	12,7	97,8	231,0
83952	16 x 2 x 0,34	22	12,7	104,6	240,0	65262	16 x 2 x 0,34	22	12,7	104,6	240,0
83953	18 x 2 x 0,34	22	13,6	117,8	264,0	65263	18 x 2 x 0,34	22	13,6	117,8	264,0
83954	20 x 2 x 0,34	22	14,4	130,7	291,0	65264	20 x 2 x 0,34	22	14,4	130,7	291,0
83955	22 x 2 x 0,34	22	15,1	143,6	300,0	65265	22 x 2 x 0,34	22	15,1	143,6	300,0
83956	24 x 2 x 0,34	22	16,2	156,8	359,0	65266	24 x 2 x 0,34	22	16,2	156,8	359,0
83957	25 x 2 x 0,34	22	16,7	163,3	381,0	65267	25 x 2 x 0,34	22	16,7	163,3	381,0
83958	1 x 2 x 0,56	20	4,6	10,8	60,0	65268	1 x 2 x 0,56	20	4,6	10,8	60,0
83959	2 x 2 x 0,56	20	6,5	21,5	80,0	65269	2 x 2 x 0,56	20	6,5	21,5	80,0
83960	3 x 2 x 0,56	20	7,1	32,3	94,0	65270	3 x 2 x 0,56	20	7,1	32,3	94,0
83961	4 x 2 x 0,56	20	7,8	43,1	104,0	65271	4 x 2 x 0,56	20	7,8	43,1	104,0
83962	5 x 2 x 0,56	20	8,6	53,8	130,0	65272	5 x 2 x 0,56	20	8,6	53,8	130,0
83963	6 x 2 x 0,56	20	9,6	64,6	151,0	65273	6 x 2 x 0,56	20	9,6	64,6	151,0
83964	7 x 2 x 0,56	20	9,6	75,3	174,0	65274	7 x 2 x 0,56	20	9,6	75,3	174,0
83965	8 x 2 x 0,56	20	12,2	86,1	262,0	65275	8 x 2 x 0,56	20	12,1	86,1	262,0
83966	10 x 2 x 0,56	20	12,5	107,7	298,0	65276	10 x 2 x 0,56	20	12,5	107,7	298,0
83967	12 x 2 x 0,56	20	13,1	129,1	302,0	65277	12 x 2 x 0,56	20	13,1	129,1	302,0
83968	14 x 2 x 0,56	20	13,8	150,6	327,0	65278	14 x 2 x 0,56	20	13,8	150,6	327,0
83969	15 x 2 x 0,56	20	14,7	161,3	370,0	65279	15 x 2 x 0,56	20	14,7	161,3	370,0
83970	16 x 2 x 0,56	20	14,7	172,1	402,0	65280	16 x 2 x 0,56	20	14,7	172,1	402,0
83971	18 x 2 x 0,56	20	15,7	193,6	480,0	65281	18 x 2 x 0,56	20	15,7	193,6	480,0
83972	20 x 2 x 0,56	20	16,7	215,1	551,0	65282	20 x 2 x 0,56	20	16,7	215,1	551,0
83973	22 x 2 x 0,56	20	17,2	236,6	621,0	65283	22 x 2 x 0,56	20	17,2	236,6	621,0
83974	24 x 2 x 0,56	20	18,6	258,0	703,0	65284	24 x 2 x 0,56	20	18,6	258,0	703,0
83975	25 x 2 x 0,56	20	19,2	268,9	721,0	65285	25 x 2 x 0,56	20	19,2	268,9	721,0

Dimensions and specifications may be changed without prior notice. (RN02)

Command Cable UL (LiYCY-TP)

Style 2464, 300 V, 80°C, Cu-screened, EMC-preferred type

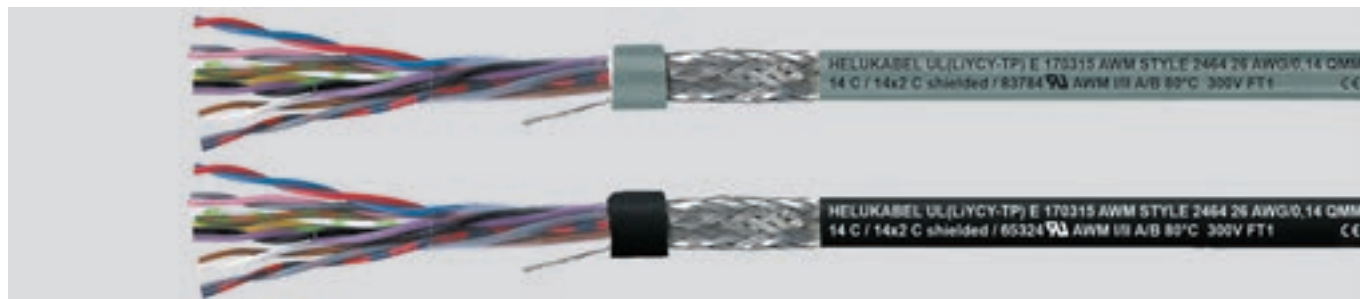

Technical data

- Special PVC command cable approved to UL Style 2464, cores acc. to UL Style 1061/1729
- **Temperature range**
flexing -10°C to +80°C
fixed installation -20°C to +80°C
- **Nominal voltage**
300 V
- **Test voltage**
1500 V
- **Breakdown voltage**
min. 3000 V
- **Insulation resistance**
min. 100 MOhm x km
- **Minimum bending radius**
flexing 15x cable Ø
fixed installation 7,5x cable Ø
- **Coupling resistance**
max. 250 Ohm/km

Cable structure

- Tinned copper conductor, fine wire, acc. to ASTM-B 174-95 class J-M
Conductor make-up to:
0,14 mm² = 7x0,162 mm
0,23 mm² = 7x0,202 mm
0,34 mm² = 7x0,254 mm
0,56 mm² = 7x0,32 mm
- Core insulation of special PVC class 43 respectively semirigid acc. to UL Std. 1581 tab.50.182 and 50183
- Core identification (pair) to DIN 47100 with colour repetition from pair no. 23 and above or international colour code
- Cores stranded in pairs with optimal lay length
- Pairs stranded in layers with optimal lay length
- Separator-foil
- Drain wire
- Tinned copper wire braiding, approx. 85% coverage
- Outer sheath of special PVC class 43 acc. to UL Std. 1581 tab.50.182
- Sheath colour:
black (international colour code)
grey (DIN 47100 - preferred type)

Properties

- The materials used during manufacturing are cadmium-free, contain no silicone and are free from substances harmful to the wetting properties of lacquers
- **To a large extent resistant to**
Oil
Solvents
Acids
Lyes

Tests

- PVC flame retardant acc. to UL VW-1, CSA FT1

Note

- AWG sizes are approximate equivalent values. The actual cross section is in mm².
- Uncreened analogue type:
command cable UL (LiYY-TP)

Application

Flexible, screened, twisted pair control and measuring cable; for machine tools, conveyor belts, plant construction, AC technology, steel production. In order to enhance EMC properties, a large contact area on both sides of the copper braiding is recommended.

EMC = Electromagnetic compatibility

To optimize the EMC features we recommend a large round contact of the copper braiding on both ends.

CE = Product conforms with Low-Voltage Directive 2014/35/EU.

Part no.	Sheath colour	Sheath colour black	No.pairs x cross-sec. mm ²	AWG-No.	Outer Ø app. mm	Cop. weight kg / km	Weight app. kg / km
83774	grey	black	1 x 2 x 0,14	26	4,0	15,7	32,0
83775	grey	black	2 x 2 x 0,14	26	5,6	19,5	39,0
83776	grey	black	3 x 2 x 0,14	26	5,8	23,7	47,0
83777	grey	black	4 x 2 x 0,14	26	6,3	26,9	55,0
83778	grey	black	5 x 2 x 0,14	26	6,7	31,2	68,0
83779	grey	black	6 x 2 x 0,14	26	7,3	49,7	86,0
83780	grey	black	7 x 2 x 0,14	26	7,3	52,0	92,0
83781	grey	black	8 x 2 x 0,14	26	7,8	53,9	97,0
83782	grey	black	10 x 2 x 0,14	26	9,1	59,6	111,0
83783	grey	black	12 x 2 x 0,14	26	9,8	67,1	141,0
83784	grey	black	14 x 2 x 0,14	26	10,5	75,2	150,0
83785	grey	black	15 x 2 x 0,14	26	11,1	77,3	154,0
83786	grey	black	16 x 2 x 0,14	26	11,1	80,4	155,0
83787	grey	black	18 x 2 x 0,14	26	11,8	84,2	170,0
83788	grey	black	20 x 2 x 0,14	26	12,4	98,2	183,0
83789	grey	black	22 x 2 x 0,14	26	13,1	104,1	207,0
83790	grey	black	24 x 2 x 0,14	26	13,6	112,0	228,0
83791	grey	black	25 x 2 x 0,14	26	15,1	114,4	239,0

Part no.	Sheath colour	Sheath colour black	No.pairs x cross-sec. mm ²	AWG-No.	Outer Ø app. mm	Cop. weight kg / km	Weight app. kg / km
83792	grey	black	1 x 2 x 0,23	24	4,2	16,4	46,0
83793	grey	black	2 x 2 x 0,23	24	5,9	27,4	53,0
83794	grey	black	3 x 2 x 0,23	24	6,2	31,7	65,0
83795	grey	black	4 x 2 x 0,23	24	6,7	37,4	79,0
83796	grey	black	5 x 2 x 0,23	24	7,2	54,7	98,0
83797	grey	black	6 x 2 x 0,23	24	7,7	65,6	114,0
83798	grey	black	7 x 2 x 0,23	24	7,7	60,2	121,0
83799	grey	black	8 x 2 x 0,23	24	8,4	74,1	129,0
83800	grey	black	10 x 2 x 0,23	24	9,9	109,3	152,0
83801	grey	black	12 x 2 x 0,23	24	10,2	115,8	189,0
83802	grey	black	14 x 2 x 0,23	24	10,9	120,7	213,0
83803	grey	black	15 x 2 x 0,23	24	11,4	132,4	225,0
83804	grey	black	16 x 2 x 0,23	24	11,4	141,6	227,0
83805	grey	black	18 x 2 x 0,23	24	12,2	146,6	238,0
83806	grey	black	20 x 2 x 0,23	24	12,7	160,6	270,0
83807	grey	black	22 x 2 x 0,23	24	13,5	170,8	300,0
83808	grey	black	24 x 2 x 0,23	24	14,5	229,7	321,0
83809	grey	black	25 x 2 x 0,23	24	14,8	231,4	340,0

Continuation ▶

Command Cable UL (LiYCY-TP)

Style 2464, 300 V, 80°C, Cu-screened, EMC-preferred type



Part no.	Sheath colour	Sheath colour	No.pairs x cross-sec. mm ²	AWG-No.	Outer Ø app. mm	Cop. weight kg / km	Weight app. kg / km	Part no.	Sheath colour	Sheath colour	No.pairs x cross-sec. mm ²	AWG-No.	Outer Ø app. mm	Cop. weight kg / km	Weight app. kg / km
83810	grey	black	1 x 2 x 0,34	22	4,6	17,0	58,0	83828	grey	black	1 x 2 x 0,56	20	5,0	26,0	70,0
83811	grey	black	2 x 2 x 0,34	22	6,4	36,7	65,0	83829	grey	black	2 x 2 x 0,56	20	7,0	56,1	89,0
83812	grey	black	3 x 2 x 0,34	22	6,9	44,6	78,0	83830	grey	black	3 x 2 x 0,56	20	7,6	71,7	102,0
83813	grey	black	4 x 2 x 0,34	22	7,5	54,1	88,0	83831	grey	black	4 x 2 x 0,56	20	8,3	92,4	119,0
83814	grey	black	5 x 2 x 0,34	22	8,1	63,4	110,0	83832	grey	black	5 x 2 x 0,56	20	9,1	107,4	140,0
83815	grey	black	6 x 2 x 0,34	22	8,8	73,4	126,0	83833	grey	black	6 x 2 x 0,56	20	10,1	122,4	162,0
83816	grey	black	7 x 2 x 0,34	22	8,8	79,4	140,0	83834	grey	black	7 x 2 x 0,56	20	10,1	131,7	198,0
83817	grey	black	8 x 2 x 0,34	22	9,7	88,4	148,0	83835	grey	black	8 x 2 x 0,56	20	12,7	144,3	272,0
83818	grey	black	10 x 2 x 0,34	22	11,5	107,0	184,0	83836	grey	black	10 x 2 x 0,56	20	13,2	179,6	307,0
83819	grey	black	12 x 2 x 0,34	22	12,0	122,4	210,0	83837	grey	black	12 x 2 x 0,56	20	13,6	201,7	318,0
83820	grey	black	14 x 2 x 0,34	22	12,6	138,2	241,0	83838	grey	black	14 x 2 x 0,56	20	14,4	221,4	342,0
83821	grey	black	15 x 2 x 0,34	22	13,4	154,3	245,0	83839	grey	black	15 x 2 x 0,56	20	15,5	231,6	381,0
83822	grey	black	16 x 2 x 0,34	22	13,4	161,4	251,0	83840	grey	black	16 x 2 x 0,56	20	15,5	257,1	417,0
83823	grey	black	18 x 2 x 0,34	22	14,4	197,9	275,0	83841	grey	black	18 x 2 x 0,56	20	16,3	282,4	494,0
83824	grey	black	20 x 2 x 0,34	22	15,0	211,4	300,0	83842	grey	black	20 x 2 x 0,56	20	17,1	306,7	570,0
83825	grey	black	22 x 2 x 0,34	22	15,9	217,6	320,0	83843	grey	black	22 x 2 x 0,56	20	18,0	321,8	643,0
83826	grey	black	24 x 2 x 0,34	22	17,0	230,4	371,0	83844	grey	black	24 x 2 x 0,56	20	19,4	342,4	724,0
83827	grey	black	25 x 2 x 0,34	22	17,3	237,0	402,0	83845	grey	black	25 x 2 x 0,56	20	19,8	361,2	740,0

Dimensions and specifications may be changed without prior notice. (RN02)

SUPERTRONIC® -PURö

special cable for drag chains, meter marking



Technical data

- Special PUR drag chain cables adapted to DIN VDE 0285-525-2-51 / DIN EN 50525-2-51
- Very high flexible due to special construction
- **Temperature range**
flexing -5°C to +70°C
fixed installation -40°C to +70°C
- **Nominal voltage**
350 V
- **Test voltage**
1500 V
- **Breakdown voltage**
min. 3000 V
- **Insulation resistance**
min. 20 MOhm x km
- **Minimum bending radius**
flexing 5x cable Ø
fixed installation 3x cable Ø
- **Radiation resistance**
up to 100x10⁶ cJ/kg (up to 100 Mrad)

Cable structure

- Bare copper conductor, extra fine wire, acc. to DIN VDE 0295 cl.6, col. 4 and 5 IEC 60228 cl.6
- **Oil resistant** PVC core insulation T12, adapted to DIN VDE 0207-363-3 / DIN EN 50363-3, for better sliding abilities
- Core identification to DIN 47100, coloured
- Cores stranded in layers with optimal lay length
- Core wrapping with textile tape
- Outer sheath of special **full-polyurethane** TMPU to DIN VDE 0207-363-10-2 / DIN EN 50363-10-2
- Sheath colour: grey (RAL 7001), surface mat
- With meter marking

Properties

- **Features**
High flexibility at low temperature, high abrasion resistance, break and cut-resistant, tear resistant
- **Resistant to**
UV-radiation, Oxygen, Ozone, Hydrolyse, Oil.
- **Conditional resistant to**
Microbes, Hydraulic liquidity, Alkalis, Lye.
- The PUR outer sheath is extremely robust with high tear, abrasion and oil-resistance.
- Adhesion-low
- The materials used during manufacturing are cadmium-free, contain no silicone and are free from substances harmful to the wetting properties of lacquers

Note

- AWG sizes are approximate equivalent values. The actual cross section is in mm².

Application

Perfect for use with cable trays. This highly flexible PUR control cable is ideal for use wherever frequent high flexing motion is required, e. g. in robotics or all moving parts. The long working life of this cable makes it both efficient and economic. For applications which go beyond standard solutions (for example for composting appliances or high shelf conveyors with extremely high processing speeds etc.) we recommend for our especially developed enquiry sheet for energy guiding systems. Before installation in cable trays please read the instructions. Further technical details see selection table for drag chain cables, see chapter "Technical Informations".

☑ = Product conforms with Low-Voltage Directive 2014/35/EU.

Part no.	No. cores x cross-sec. mm ²	Outer Ø app. mm	Cop. weight kg / km	Weight app. kg / km	AWG-No.
49583	2 x 0,14	3,5	2,8	22,0	26
49584	3 x 0,14	3,7	4,1	24,0	26
49585	4 x 0,14	3,9	5,6	29,0	26
49586	5 x 0,14	4,2	7,0	33,0	26
49587	7 x 0,14	4,9	9,8	47,0	26
49588	10 x 0,14	6,2	14,0	59,0	26
49589	12 x 0,14	6,4	16,8	67,0	26
49590	14 x 0,14	6,6	19,6	74,0	26
49591	18 x 0,14	7,3	25,2	86,0	26
49592	24 x 0,14	8,5	33,6	115,0	26
49593	25 x 0,14	8,6	35,0	120,0	26
49594	2 x 0,25	4,1	5,0	27,0	24
49595	3 x 0,25	4,3	7,5	33,0	24
49596	4 x 0,25	4,8	10,0	40,0	24
49597	5 x 0,25	5,2	12,5	48,0	24
49598	7 x 0,25	6,2	17,5	60,0	24
49599	10 x 0,25	7,4	25,0	79,0	24

Part no.	No. cores x cross-sec. mm ²	Outer Ø app. mm	Cop. weight kg / km	Weight app. kg / km	AWG-No.
49600	12 x 0,25	7,6	30,1	91,0	24
49601	14 x 0,25	7,9	35,0	102,0	24
49602	18 x 0,25	8,9	45,0	125,0	24
49603	24 x 0,25	10,0	60,0	163,0	24
49604	25 x 0,25	10,6	62,5	170,0	24
49605	2 x 0,34	4,5	6,8	32,0	22
49606	3 x 0,34	4,9	10,2	40,0	22
49607	4 x 0,34	5,3	13,6	55,0	22
49608	5 x 0,34	5,8	17,0	60,0	22
49609	7 x 0,34	6,9	23,8	80,0	22
49610	10 x 0,34	8,4	34,0	112,0	22
49611	12 x 0,34	8,6	40,8	127,0	22
49612	14 x 0,34	9,0	47,6	142,0	22
49613	18 x 0,34	10,1	61,2	175,0	22
49614	24 x 0,34	12,0	81,5	229,0	22
49615	25 x 0,34	12,2	85,0	238,0	22

Dimensions and specifications may be changed without prior notice. (RC03)

SUPERTRONIC® -C-PURö

special cable for drag chains, halogen-free, EMC-preferred type, meter marking

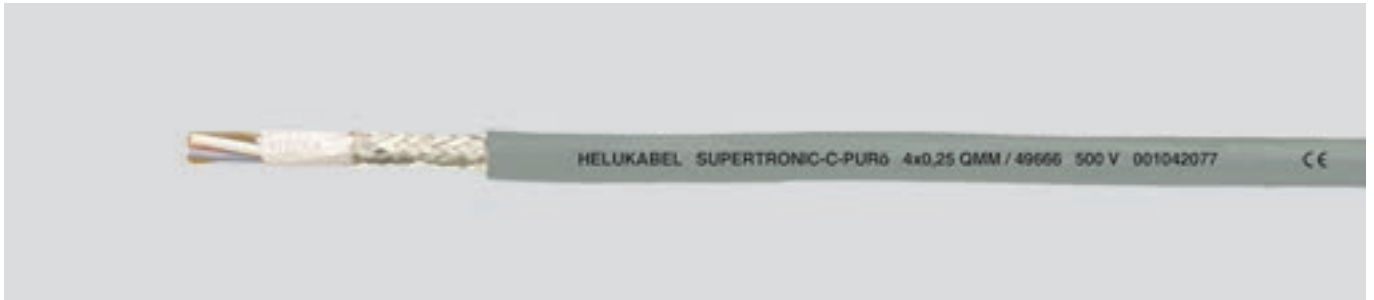

Technical data

- Special PUR drag chain cables, screened, adapted to DIN VDE 0285-525-2-51 / DIN EN 50525-2-51
- **Temperature range**
flexing -30°C to +70°C
fixed installation -40°C to +70°C
- **Nominal voltage**
0,14 mm² 350 V
0,25 and 0,34 mm² 500 V
- **Test voltage**
0,14 mm² 800 V
0,25 and 0,34 mm² 1200 V
- **Insulation resistance**
min. 100 MOhm x km
- **Capacitance**
core/core < 80 nF/km
- **Minimum bending radius**
flexing 7,5x cable Ø
fixed installation 4x cable Ø
- **Radiation resistance**
up to 100x10⁶ cJ/kg (up to 100 Mrad)

Cable structure

- Bare copper conductors, extra fine wire, acc. to DIN VDE 0295 cl.6, col.4 and 5, IEC 60228 cl.6
- Core insulation of PP
- Core identification to DIN 47100, coloured
- Cores stranded in layers with optimal lay length
- Core wrapping with textile tape
- Tinned copper braided screen, approx. 85% coverage.
- Outer sheath of special **full-polyurethane** TMPU to DIN VDE 0207-363-10-2 / DIN EN 50363-10-2
- Sheath colour: grey (RAL 7001), surface mat
- With meter marking

Properties

- **Features**
High flexibility at low temperature, high abrasion resistance, break and cut-resistant, tear resistant
- **Resistant to**
UV-radiation, Oxygen, Ozone, Hydrolyse, Oil
- **Conditional resistant to**
Microbes, Hydraulic liquidity, Alkalis, Lye
- The PUR outer sheath is extremely robust with high tear, abrasion and oil-resistance
- Adhesion-low
- The materials used during manufacturing are cadmium-free, contain no silicone and are free from substances harmful to the wetting properties of lacquers

Note

- AWG sizes are approximate equivalent values. The actual cross section is in mm².

Application

Used for installation in dry, moist and wet environments as well as for outdoors, for free movement without forced motion and for flexible routing without forced motion, for proven use as drag-chain cables. Suitable as a highly flexible control cable for fast hoisting and bending stresses in machinery and tooling construction, in robotics engineering and for continuously moving machinery parts. The long working life of this cable makes it both efficient and economic. The copper braided screening offers effective protection from both internal and external interference. For applications which go beyond standard solutions (for example for composting appliances or high shelf conveyors with extremely high processing speeds etc.) we recommend for our especially developed enquiry sheet for energy guiding systems. Before installation in cable trays please read the instructions. Further technical details see selection table for drag chain cables, see chapter "Technical Informations".

EMC = Electromagnetic compatibility

To optimize the EMC features we recommend a large round contact of the copper braiding on both ends.

☑ = Product conforms with Low-Voltage Directive 2014/35/EU.

Part no.	No. cores x cross-sec. mm ²	Outer Ø app. mm	Cop. weight kg / km	Weight app. kg / km	AWG-No.
49653	2 x 0,14	4,1	11,2	32,0	26
49654	3 x 0,14	4,3	14,1	35,0	26
49655	4 x 0,14	4,5	15,5	40,0	26
49656	5 x 0,14	4,8	18,3	45,0	26
49657	7 x 0,14	5,7	27,8	66,0	26
49658	10 x 0,14	6,7	39,3	86,0	26
49659	12 x 0,14	6,9	42,1	94,0	26
49660	14 x 0,14	7,1	45,3	102,0	26
49661	18 x 0,14	7,8	54,1	118,0	26
49662	24 x 0,14	9,0	66,3	149,0	26
49663	25 x 0,14	9,1	68,4	156,0	26
49664	2 x 0,25	4,6	14,9	38,0	24
49665	3 x 0,25	4,8	18,8	44,0	24
49666	4 x 0,25	5,3	21,3	51,0	24
49667	5 x 0,25	5,7	31,0	68,0	24
49668	7 x 0,25	6,7	39,6	82,0	24
49669	10 x 0,25	8,2	53,9	110,0	24

Part no.	No. cores x cross-sec. mm ²	Outer Ø app. mm	Cop. weight kg / km	Weight app. kg / km	AWG-No.
49670	12 x 0,25	8,4	59,1	124,0	24
49671	14 x 0,25	8,7	64,2	135,0	24
49672	18 x 0,25	9,5	78,4	160,0	24
49673	24 x 0,25	11,0	89,9	202,0	24
49674	25 x 0,25	11,1	101,0	211,0	24
49675	2 x 0,34	5,0	18,1	45,0	22
49676	3 x 0,34	5,4	28,7	60,0	22
49677	4 x 0,34	6,2	35,7	76,0	22
49678	5 x 0,34	6,7	39,1	82,0	22
49679	7 x 0,34	7,6	52,7	110,0	22
49680	10 x 0,34	9,2	67,4	148,0	22
49681	12 x 0,34	9,4	76,4	166,0	22
49682	14 x 0,34	10,0	85,5	185,0	22
49683	18 x 0,34	10,9	99,7	216,0	22
49684	24 x 0,34	12,6	147,1	300,0	22
49685	25 x 0,34	12,8	155,0	313,0	22

Dimensions and specifications may be changed without prior notice. (RC03)

SUPERTRONIC® -330 PURÖ

cable for drag chains, halogen-free, meter marking



Technical data

- Special PUR sheathed cable
- **Temperature range**
flexing -30°C to +80°C
fixed installation -40°C to +80°C
- **Nominal voltage**
300 V
- **Test voltage**
core/core 1500 V
- **Insulation resistance**
min. 100 MOhm x km
- **Capacitance**
core/core 60 nF/km
- **Minimum bending radius**
flexing 5x cable Ø
fixed installation 3x cable Ø
- **Radiation resistance**
up to 100x10⁶ cJ/kg (up to 100 Mrad)

Cable structure

- Bare copper conductor, extra fine wire, acc. to DIN VDE 0295 cl.6, col. 4, BS 6360 cl.6
- Core insulation of PP
- Core identification to DIN 47100, coloured
- Cores stranded in layers with optimal lay length
- Wrapping over the outer layer
- Outer sheath of special **full-polyurethane** compound type TMPJU to DIN VDE 0282 part 10, Annex A and acc. to UL Std.1581 tab.50227
- Sheath colour: grey (RAL 7001)
- With meter marking

Properties

- The materials used during manufacturing are cadmium-free, contain no silicone and are free from substances harmful to the wetting properties of lacquers
- Low adhesion
- High flexibility at low temperatures
- High abrasion resistance
- Tear and cut-resistant
- Notch resistant
- **Resistant to**
UV-radiation, Oxygen, Ozone, Hydrolysis, Oil
- **Partially resistant to**
Microbial attack, Hydraulic fluids, Coolant emulsion, Alkalis

Tests

- PUR outer sheath, flame retardant acc. to DIN VDE 0482-332-1-2, DIN EN 60332-1-2, IEC 60332-1-2 (equivalent DIN VDE 0472 part 804 test method B)

Note

- AWG sizes are approximate equivalent values. The actual cross section is in mm².

Application

For installation in dry, moist and wet rooms and outdoors with free movement without tensile stress or forced movements, impressively proven in drag chain application. A highly flexible PUR control cable, suitable for frequent and quick lifting and bending stresses in machine engineering and construction, in robot technology and on permanently moving machine components. Long service life guarantees reliable function and high cost-efficiency. For applications which go beyond standard solutions (for example for composting appliances or high shelf conveyors with extremely high processing speeds etc.) we recommend for our especially developed enquiry sheet for energy guiding systems. Before installation in cable trays please read the instructions. Further technical details see selection table for drag chain cables, see chapter "Technical Informations". Attractive for export-oriented mechanical engineering.

CE = Product conforms with Low-Voltage Directive 2014/35/EU.

Part no.	No. cores x cross-sec. mm ²	AWG-No.	Outer Ø app. mm	Cop. weight kg / km	Weight app. kg / km
49764	2 x 0,14	26	3,9	2,8	22,0
49765	3 x 0,14	26	4,0	4,1	24,0
49766	4 x 0,14	26	4,3	5,6	29,0
49767	5 x 0,14	26	4,7	7,0	33,0
49768	7 x 0,14	26	5,3	9,8	47,0
49769	10 x 0,14	26	6,1	14,0	57,0
49770	12 x 0,14	26	6,2	16,8	63,0
49771	14 x 0,14	26	6,5	19,6	72,0
49772	18 x 0,14	26	7,2	25,2	80,0
49773	24 x 0,14	26	8,2	33,6	110,0
49774	25 x 0,14	26	8,6	35,0	115,0
49775	2 x 0,25	24	4,3	5,0	26,0
49776	3 x 0,25	24	4,5	7,5	30,0
49777	4 x 0,25	24	4,8	10,0	39,0
49778	5 x 0,25	24	5,2	12,5	44,0
49779	7 x 0,25	24	6,0	17,5	52,0
49780	10 x 0,25	24	6,9	25,0	70,0

Part no.	No. cores x cross-sec. mm ²	AWG-No.	Outer Ø app. mm	Cop. weight kg / km	Weight app. kg / km
49781	12 x 0,25	24	7,1	30,1	84,0
49782	14 x 0,25	24	7,4	35,0	97,0
49783	18 x 0,25	24	8,2	45,0	114,0
49784	24 x 0,25	24	9,6	60,0	157,0
49785	25 x 0,25	24	10,1	62,5	160,0
49786	2 x 0,34	22	4,6	6,8	31,0
49787	3 x 0,34	22	4,8	10,2	38,0
49788	4 x 0,34	22	5,2	13,6	51,0
49789	5 x 0,34	22	5,6	17,0	54,0
49790	7 x 0,34	22	6,5	23,8	77,0
49791	10 x 0,34	22	7,5	34,0	104,0
49792	12 x 0,34	22	7,7	40,8	122,0
49793	14 x 0,34	22	8,1	47,6	140,0
49794	18 x 0,34	22	9,2	61,2	162,0
49795	24 x 0,34	22	10,7	81,5	204,0
49796	25 x 0,34	22	11,2	85,0	229,0

Dimensions and specifications may be changed without prior notice. (RN05)

SUPERTRONIC® -330 C-PURÖ

cable for drag chains, halogen-free, EMC-preferred type, meter marking



Technical data

- Special PUR sheathed cable, screened
- **Temperature range**
flexing -30°C to +80°C
fixed installation -40°C to +80°C
- **Nominal voltage**
300 V
- **Test voltage**
core/core 1500 V
core/screen 1000 V
- **Insulation resistance**
min. 100 MΩm x km
- **Capacitance**
core/core 60 nF/km
- **Minimum bending radius**
flexing 7,5x cable Ø
fixed installation 4x cable Ø
- **Radiation resistance**
up to 100x10⁶ cJ/kg (up to 100 Mrad)
- **Coupling resistance**
max. 250 Ωm/km

Cable structure

- Bare copper conductor, extra fine wire, acc. to DIN VDE 0295 cl.6, col. 4, BS 6360 cl.6
- Core insulation of PP
- Core identification to DIN 47100 coloured
- Cores stranded in layers with optimal lay length
- Wrapping over the outer layer
- Braided screen of tinned Cu wires, coverage approx. 85%
- Core wrapping with fleece
- Outer sheath of special **full polyurethane** compound type TMPU to DIN VDE 0207-363-10-2 / DIN EN 50363-10-2 and acc. to UL Std.1581 tab.50227
- Sheath colour: grey (RAL 7001)
- With meter marking

Properties

- The materials used during manufacturing are cadmium-free, contain no silicone and are free from substances harmful to the wetting properties of lacquers
- Low-adhesion
- High flexibility at low temperatures
- High abrasion resistance
- Tear and cut-resistant
- Notch resistant
- **Resistant to**
UV-radiation, Oxygen, Ozone, Hydrolysis, Oil
- **Partially resistant to**
Microbial attack, Hydraulic fluid, Coolant emulsion, Alkalis

Tests

- PUR outer sheath, flame retardant acc. to DIN VDE 0482-332-1-2, DIN EN 60332-1-2, IEC 60332-1-2 (equivalent DIN VDE 0472 part 804 test method B)

Note

- AWG sizes are approximate equivalent values. The actual cross section is in mm².

Application

Especially suited for drag chain installation in dry, moist and wet environments and outdoors with flexible movement and without tensile stress or forced movements. A highly flexible PVC control cable suitable for frequent and fast lifting and bending stresses in machines and tool building, robot systems and on constantly moving machine components. Long service lives guarantee reliable function and good cost efficiency. The dense screening assures interference-free transmission of all signals and impulses. An ideal interference-free control cable for the above applications. For applications which go beyond standard solutions (for example for composting appliances or high shelf conveyors with extremely high processing speeds etc.) we recommend for our especially developed enquiry sheet for energy guiding systems. Before installation in cable trays please read the instructions. Further technical details see selection table for drag chain cables, see lead text.

EMC = Electromagnetic compatibility

To optimize the EMC features we recommend a large round contact of the copper braiding on both ends.

☑ = Product conforms with Low-Voltage Directive 2014/35/EU.

Part no.	No.cores x cross-sec. mm ²	AWG-No.	Outer Ø app. mm	Cop. weight kg / km	Weight app. kg / km
49797	2 x 0,14	26	4,4	11,2	32,0
49798	3 x 0,14	26	4,5	14,1	35,0
49799	4 x 0,14	26	4,8	15,5	40,0
49800	5 x 0,14	26	5,0	18,3	45,0
49801	7 x 0,14	26	5,8	27,8	66,0
49802	10 x 0,14	26	6,7	39,3	86,0
49803	12 x 0,14	26	6,8	42,1	94,0
49804	14 x 0,14	26	7,1	45,3	102,0
49805	18 x 0,14	26	7,8	54,1	118,0
49806	24 x 0,14	26	8,8	66,3	149,0
49807	25 x 0,14	26	9,2	68,4	156,0
49808	2 x 0,25	24	4,8	14,9	38,0
49809	3 x 0,25	24	5,0	18,8	44,0
49810	4 x 0,25	24	5,3	21,3	51,0
49811	5 x 0,25	24	5,7	31,0	68,0
49812	7 x 0,25	24	6,6	39,6	82,0
49813	10 x 0,25	24	7,5	53,9	110,0

Part no.	No.cores x cross-sec. mm ²	AWG-No.	Outer Ø app. mm	Cop. weight kg / km	Weight app. kg / km
49814	12 x 0,25	24	7,7	59,1	124,0
49815	14 x 0,25	24	8,0	64,2	135,0
49816	18 x 0,25	24	8,8	78,4	150,0
49817	24 x 0,25	24	10,2	89,9	194,0
49818	25 x 0,25	24	10,7	101,0	204,0
49819	2 x 0,34	22	5,1	18,1	45,0
49820	3 x 0,34	22	5,3	28,7	60,0
49821	4 x 0,34	22	5,7	35,7	76,0
49822	5 x 0,34	22	6,1	39,1	82,0
49823	7 x 0,34	22	7,1	52,7	110,0
49824	10 x 0,34	22	8,1	67,4	148,0
49825	12 x 0,34	22	8,3	76,4	166,0
49826	14 x 0,34	22	8,7	85,5	185,0
49827	18 x 0,34	22	9,8	99,7	216,0
49828	24 x 0,34	22	11,3	147,1	291,0
49829	25 x 0,34	22	11,8	155,0	305,0

Dimensions and specifications may be changed without prior notice. (RN05)

SUPER-PAAR-TRONIC-C-PUR®

cable for drag chains, halogen-free, EMC-preferred type, meter marking



Technical data

- Special drag chain cable, twisted in pairs, adapted to DIN VDE 0812
- **Temperature range**
flexing -30°C to +70°C
fixed installation -40°C to +70°C
- **Nominal voltage**
350 V
- **Test voltage**
1500 V
- **Insulation resistance**
min. 100 MOhm x km
- **Mutual capacitance**
approx. 135 nF/km
- **Minimum bending radius**
flexing
at 0,25 mm²: 7,5x cable Ø
at 0,5 - 1 mm²: 10x cable Ø
fixed installation
at 0,25 mm²: 4x cable Ø
at 0,5 - 1 mm²: 5x cable Ø
- **Coupling resistance**
max. 250 Ohm/km
- **Radiation resistance**
up to 100x10⁶ cJ/kg (up to 100 Mrad)

Cable structure

- Bare copper conductors, extra fine wire acc. to DIN VDE 0295 cl.6, col. 4, BS 6360 cl.6 and IEC 60228 cl.6
- Core insulation of PP
- Core identification to DIN 47100
- Cores twisted in pairs, the pairs torsion-free stranded in layers
- Special fleece over outer layer
- Tinned copper screened braiding, approx. 85% coverage
- Outer sheath of **full-polyurethane** compound type TMPU to DIN VDE 0207-363-10-2 / DN EN 50363-10-2
- Sheath colour: grey (RAL 7001)
- With meter marking

Properties

- Very good oil resistant
- Resistant to weather, ozone, hydrolysis- and UV-radiation
- Chemical resistant to solvents, acids, lyes and hydraulic liquidity
- Guaranteed permanent application in multi-shift operation under extreme high bending stress
- High resistant to mechanical strain
- High property of alternating bending strength
- Long life durabilities through low friction-resistance by using the PP-core insulation where the core are stranded in layers
- High tensile strength-, abrasion- and impact resistant at low temperature
- Adhesion-low
- The materials used during manufacturing are cadmium-free, contain no silicone and are free from substances harmful to the wetting properties of lacquers

Note

- AWG sizes are approximate equivalent values. The actual cross section is in mm².

Application

These pair stranded and overall screened special cables for drag chains offer the operational possibilities where the outer electrical influences at high frequency cause interference of impulse transmission, are applied for permanent flexible operations in machineries, machine tools, robot technics, for movable automated machinery parts and multi-shift-operation as a transmission-cable. These highly flexible data cables are developed according to the newest state of technology improvement and with its sliding abilities by using the PP-core insulation and adhesion-low and cut-resistant PUR-outer sheath, guaranteed an optimum life durabilities and highly economic. For applications which go beyond standard solutions (for example for composting appliances or high shelf conveyors with extremely high processing speeds etc.) we recommend for our especially developed enquiry sheet for energy guiding systems. Before installation in cable trays please read the instructions. Further technical details see selection table for drag chain cables, see chapter "Technical infomations".

EMC = Electromagnetic compatibility

To optimize the EMC features we recommend a large round contact of the copper braiding on both ends.

= Product conforms with Low-Voltage Directive 2014/35/EU.

Part no.	No.pairs x cross-sec. mm ²	Outer Ø app. mm	Cop. weight kg / km	Weight app. kg / km	AWG-No.
19101	1 x 2 x 0,25	4,9	14,0	28,0	24
19102	2 x 2 x 0,25	6,8	32,0	61,0	24
19103	3 x 2 x 0,25	7,2	38,4	73,0	24
19104	4 x 2 x 0,25	7,7	43,2	90,0	24
19105	5 x 2 x 0,25	8,6	51,5	105,0	24
19106	6 x 2 x 0,25	9,2	71,8	133,0	24
19107	8 x 2 x 0,25	10,6	74,4	156,0	24
19108	10 x 2 x 0,25	11,7	90,0	188,0	24
19109	14 x 2 x 0,25	12,7	111,2	220,0	24
19119	1 x 2 x 0,5	5,7	22,0	47,0	20
19120	2 x 2 x 0,5	8,2	50,0	100,0	20
19121	3 x 2 x 0,5	8,8	71,8	131,0	20
19122	4 x 2 x 0,5	9,6	74,4	149,0	20
19123	5 x 2 x 0,5	10,6	84,5	169,0	20
19124	6 x 2 x 0,5	11,5	99,6	196,0	20
19125	8 x 2 x 0,5	13,4	144,3	285,0	20

Part no.	No.pairs x cross-sec. mm ²	Outer Ø app. mm	Cop. weight kg / km	Weight app. kg / km	AWG-No.
19126	10 x 2 x 0,5	14,9	176,0	344,0	20
19127	14 x 2 x 0,5	16,5	215,4	401,0	20
19128	1 x 2 x 0,75	6,5	34,0	61,0	19
19129	2 x 2 x 0,75	9,3	60,0	113,0	19
19130	3 x 2 x 0,75	9,8	85,7	158,0	19
19131	4 x 2 x 0,75	10,6	93,6	173,0	19
19132	5 x 2 x 0,75	11,7	113,0	203,0	19
19133	6 x 2 x 0,75	12,7	130,4	231,0	19
19134	8 x 2 x 0,75	14,9	192,2	343,0	19
19135	10 x 2 x 0,75	16,6	258,0	467,0	19
19136	14 x 2 x 0,75	18,2	316,6	546,0	19
19137	1 x 2 x 1	6,9	42,0	71,0	18
19138	2 x 2 x 1	9,9	73,0	130,0	18
19139	3 x 2 x 1	10,5	93,6	170,0	18
19140	4 x 2 x 1	11,6	117,8	204,0	18
19141	5 x 2 x 1	12,8	139,0	238,0	18

Dimensions and specifications may be changed without prior notice. (RC03)

SUPER-PAAR-TRONIC 340-C-PUR

cable for drag chains, halogen-free, EMC-preferred type, meter marking



Technical data

- Special drag chain cable, stranded in pairs
- **Temperature range**
flexing -30°C to +80°C
fixed installation -40°C to +80°C
- **Nominal voltage**
300 V
- **Test voltage**
core/core 1500 V
core/screen 1000 V
- **Insulation resistance**
min. 100 MOhm x km
- **Mutual capacitance**
core/core approx. 60 nF/km
- **Minimum bending radius**
for permanent bending
flexing
at 0,25 mm²: 7,5x cable Ø
at 0,5 - 1 mm²: 10x cable Ø
fixed installation
at 0,25 mm²: 4x cable Ø
at 0,5 - 1 mm²: 5x cable Ø
- **Coupling resistance**
max. 250 Ohm/km
- **Radiation resistance**
up to 100x10⁶ cJ/kg (up to 100 Mrad)

Cable structure

- Bare copper conductor, extra fine wire, acc. to DIN VDE 0295 cl.6, col. 4, BS 6360 cl.6 and IEC 60228 cl.6
- Core insulation of PP
- Core identification to DIN 47100
- Cores stranded in pairs, pairs stranded torsion-free in layers with optimal lay length
- Wrapping over the outer layer
- Braided screen of tinned Cu wires, coverage approx. 85%
- Core wrapping with fleece
- Outer sheath of **full polyurethane** compound type TMPU to DIN VDE 0207-363-10-2 / DIN EN 50363-10-2 and acc. to UL Std.1581 tab.50.227
- Sheath colour: grey (RAL 7001)
- With meter marking

Properties

- The materials used during manufacturing are cadmium-free, contain no silicone and are free from substances harmful to the wetting properties of lacquers
- Halogen-free
- Weather, ozone and UV resistant
- Chemical resistance to solvents, acids, alkalis and hydraulic fluids

Tests

- PUR outer sheath, flame retardant acc. to DIN VDE 0482-332-1-2, DIN EN 60332-1-2, IEC 60332-1-2 (equivalent DIN VDE 0472 part 804 test method B)
- Oil resistance acc. to DIN VDE 0473-811-404/ DIN EN 60811-404

Note

- AWG sizes are approximate equivalent values. The actual cross section is in mm².

Advantages

- Very high resistance to mechanical stresses
- Very good alternating bending strength
- High tear, abrasion and impact resistance, even at low temperatures

Application

Stranded in pairs, these fully-screened special drag chain cables can also be used where external, high-frequency interference influences pulse transfer. They are used for permanently flexible stresses in machine and tool building, in robot technology, on constantly moving machine components and for extended use in multi-shift operations. Developed to state-of-the-art technology, these highly flexible data cable, with a cut resistant and low-adhesion PUR outer sheath guaranteeing optimal service life and extremely good cost efficiency. This two-approvals single-core cable is preferred for use in export-oriented mechanical engineering, in machine tools, production lines and systems engineering. Guaranteed extended use in multi-shift operations with extremely high bending stresses. For applications which go beyond standard solutions we recommend for our especially developed enquiry sheet for energy guiding systems. Before installation in cable trays please read the instructions. Further technical details see selection table for drag chain cables, see chapter "Technical Informations".

EMC = Electromagnetic compatibility

To optimize the EMC features we recommend a large round contact of the copper braiding on both ends.

☑️ = Product conforms with Low-Voltage Directive 2014/35/EU.

Part no.	No.pairs x no.cores x cross-sec. mm ²	AWG-No.	Outer Ø app. mm	Cop. weight kg / km	Weight app. kg / km
49830	1 x 2 x 0,25	24	4,8	14,0	26,0
49831	2 x 2 x 0,25	24	6,7	32,0	61,0
49832	3 x 2 x 0,25	24	7,1	38,4	70,0
49833	4 x 2 x 0,25	24	7,6	43,2	82,0
49834	5 x 2 x 0,25	24	8,3	51,5	99,0
49835	6 x 2 x 0,25	24	9,0	71,8	126,0
49836	8 x 2 x 0,25	24	10,5	74,4	147,0
49837	10 x 2 x 0,25	24	11,9	90,0	179,0
49838	14 x 2 x 0,25	24	12,7	111,2	210,0
49839	1 x 2 x 0,34	22	5,1	20,0	35,0
49840	2 x 2 x 0,34	22	7,2	41,0	80,0
49841	3 x 2 x 0,34	22	7,6	52,2	100,0
49842	4 x 2 x 0,34	22	8,3	59,1	118,0
49843	5 x 2 x 0,34	22	9,0	67,0	134,0
49844	6 x 2 x 0,34	22	9,9	86,4	162,0
49845	8 x 2 x 0,34	22	11,9	107,5	214,0
49846	10 x 2 x 0,34	22	13,9	131,0	270,0
49847	14 x 2 x 0,34	22	14,1	150,0	304,0
49848	1 x 2 x 0,5	20	5,8	22,5	47,0
49849	2 x 2 x 0,5	20	8,4	53,0	100,0
49850	3 x 2 x 0,5	20	9,0	72,8	131,0

Part no.	No.pairs x no.cores x cross-sec. mm ²	AWG-No.	Outer Ø app. mm	Cop. weight kg / km	Weight app. kg / km
49851	4 x 2 x 0,5	20	10,0	75,6	149,0
49852	5 x 2 x 0,5	20	11,0	85,7	169,0
49853	6 x 2 x 0,5	20	11,8	103,0	181,0
49854	8 x 2 x 0,5	20	14,2	148,4	274,0
49855	10 x 2 x 0,5	20	16,5	180,0	332,0
49856	14 x 2 x 0,5	20	16,9	218,3	390,0
49857	1 x 2 x 0,75	19	6,2	35,2	56,0
49858	2 x 2 x 0,75	19	9,2	61,4	102,0
49859	3 x 2 x 0,75	19	9,8	87,1	144,0
49860	4 x 2 x 0,75	19	11,2	95,2	160,0
49861	5 x 2 x 0,75	19	12,2	115,0	193,0
49862	6 x 2 x 0,75	19	13,2	137,1	216,0
49863	8 x 2 x 0,75	19	15,6	184,4	327,0
49864	10 x 2 x 0,75	19	18,4	259,8	451,0
49865	14 x 2 x 0,75	19	18,9	318,4	521,0
49866	1 x 2 x 1	18	6,7	42,0	64,0
49867	2 x 2 x 1	18	10,0	73,0	120,0
49868	3 x 2 x 1	18	10,8	93,6	160,0
49869	4 x 2 x 1	18	11,7	117,8	184,0
49870	5 x 2 x 1	18	13,2	139,0	217,0

Dimensions and specifications may be changed without prior notice. (RN05)



TOPFLEX® 600 VFD

MULTIFLEX 600-C

JZ 604 TC Tray Cable

TC TRAY Cables

TRAYCONTROL 300-C TP

MULTIFLEX 600

TOPFLEX® 650 VFD

■ CONTROL CABLES UL LISTED

Designation	Page
UL 6141/UL 6142: New standards favour UL listed cables	190
UL listed cables: Challenges and solutions	192
TRAYCONTROL® 300	193
TRAYCONTROL® 300-C	195
TRAYCONTROL® 300 TP	197
TRAYCONTROL® 300-C TP	199
TRAYCONTROL® 500	201
TRAYCONTROL® 500-C	203
JZ 604 TC TRAY CABLE	205
JZ 604-YCY TC TRAY CABLE	207
TRAYCONTROL® 600	208
TRAYCONTROL® 600-C	210
TRAYCONTROL 610 OIL RES II	211
MULTIFLEX 600	213
MULTIFLEX 600-C	214
TOPFLEX® 600 VFD	215
TOPFLEX® 650 VFD	216

■ UL 6141/UL 6142: NEW STANDARDS FAVOUR UL LISTED CABLES

Our TRAYCONTROL® cable series and extensive portfolio of UL Listed products ensure that your systems comply with safety standards regulating the North American market.

Why did North America introduce its own standards for wind turbines?

The new Underwriters Laboratories (UL) standards aim to simplify the process of receiving final approval for wind turbines through local Authorities Having Jurisdiction (AHJ) inspectors. In the US, local AHJs need to certify that products are safe to use in accordance with general American installation regulations NEC, NESC and ANSI/IEEE C2, among others. It is not always clear whether components that comply with European CE standards also comply with American installation regulations. If there is any doubt, an AHJ inspector may shut down a construction project. UL 6141 and UL 6142 are the first American safety standards developed specifically for wind turbines. They provide a set of rules that help AHJ inspectors with the approval process, making it more transparent and predictable for everyone involved.

UL aims to harmonise with IEC 61400

For many years there were no national safety standards specifically for wind turbines in North America. The only guidelines AHJs had for reference was IEC 61400, which is the international standard for wind turbines issued by the International Electrical Commission (IEC). However, the IEC standard has been criticised in North America ever since it was published. Critics claim that it did not include enough provisions regarding electrical safety of components, controls and protection devices.

Hence, UL developed national standards to supplement IEC 61400. These standards refer directly to IEC 61400-1 (Design Requirements) and IEC 61400-2 (Small Wind Turbines), and add technical requirements primarily regarding electrical safety, control, safety devices and fire protection within wind turbines. The UL standards thereby bridge the gap between IEC standards and requirements set by national installation regulations.

UL 6142 (Small Wind Turbine Systems) has been acknowledged as a national standard by the American National Standards Institute (ANSI) since 2012. UL 6142 applies to small wind turbines that have a nominal capacity up to 1,500 V AC and can not or should not be entered by operators or service technicians for operation or maintenance.

In May 2016, ANSI issued UL 6141 (Standard for Wind Turbines Permitting Entry of Personnel) as an American National Standard. UL 6141 applies to large wind turbines that can or may be entered by operators or service technicians for operation or maintenance. Both UL standards apply exclusively to on-shore wind turbines. The latest safety standards only effect new constructions or refurbishing of wind turbines with a capacity greater than 500 kW. Existing systems do not need to be refitted.

How does UL 6141 impact the use of cables?

UL 6141 focuses primarily on electrical safety and introduces several restrictions on how cables may be used in the future. The bottom line is that appliance wiring material (AWM) – in other words, cabling material that is not UL Listed – may only be used minimally. Until now, AWM cables were frequently used in wind turbines.

UL 6141 stipulates that all accessible cables need to be installed in cable ducts. If this is impractical or impossible, e.g. in the cable loop, only so-called tray cables – cables that are approved for exposed run – are allowed. Cables in the tower and nacelle are usually accessible and therefore have to be certified for exposed run as well.

Tray cables that are designed to be used as exposed run cables, are oil and flame resistant and fulfil the increased safety requirements of UL 6141. In fact, cables need to be UL Listed in order to be classified as tray cable. Unlisted AWM cables may not be used for exposed run.



UL standards were already in place to regulate components in certain wind turbine subsystems such as generators. These standards will continue to apply. UL 6141 will apply to areas that were not regulated by a standard until now.

Local AHJ inspectors already favoured UL Listed components in the past because UL certification helps to standardise and accelerate approval processes. The recogniti-



on of UL 6141 as the national safety standard for American markets will make using UL Listed components even more prevalent. While UL 6141 does not rule out the use of AWM cables completely, it does limit their use to such an extent that UL Listed cable products will be sought-after more and more.



■ NFPA 79 EDITION 2012

Challenges and solutions

FLEXIBLE CONTROL CABLES

TRAYCONTROL 500 & TRAYCONTROL 500-C

Flexible, extremely oil-resistant control cables for open installation (ER), UL: TC-ER, PLTC-ER, ITC-ER, MTW, DP-1, WTTCC 1000V, OIL RES I & II, CSA: CIC-TC FT4, AWM I/II A/B FT4

TRAYCONTROL 600 & TRAYCONTROL 600-C

Flexible, oil-resistant TRAY CABLE for open installation (ER) UL: TC-ER, PLTC-ER, ITC-ER, MTW, DP-1, WTTCC 1000V, OIL RES I, CSA: CIC-TC FT4, AWM I/II A/B FT4

JZ 604 TC & JZ 604-FCY/YCY TC

Flexible, oil-resistant TRAY CABLE for open installation (ER) UL: TC-ER

HIGHLY FLEXIBLE CONTROL CABLES

MULTIFLEX 600 & MULTIFLEX 600-C

Highly-flexible, extremely oil-resistant cables for open installation (ER) UL: TC-ER, PLTC-ER, ITC-ER, MTW, DP-1, WTTCC 1000V, OIL RES I & II, CSA: CIC-TC FT4, AWM I/II A/B FT4

DATA CABLES

TRAYCONTROL 300 & TRAYCONTROL 300-C

Flexible, extremely oil-resistant data and control cables for open installation (ER)* UL: PLTC-ER, ITC-ER, CM, OIL RES I & II; CSA: CIC-TC FT4, CMG

TRAYCONTROL 300 TP & TRAYCONTROL 300-C TP

Flexible, extremely oil-resistant data and control cables for open installation (ER)* UL: PLTC-ER, ITC-ER, CM, OIL RES I & II; CSA: CIC-TC FT4, CMG

SINGLE CONDUCTORS

FIVENORM

The jumper wire that meets five different standards HAR: H05 V2-K/H07 V2-K; UL: MTW, AWM Style 10269; CSA: TEW bzw. AWM I/A/B

* AWG 22 - AWG 16

THHN/THWM

Flexible jumper wire UL: MTW, THHN, THWN, GASOLINE, OIL RES II, AWM W-51554

SERVO- AND MOTOR CABLES

TOPFLEX® 600 VFD

Flexible, extremely oil-resistant motor connection cables for open installation (ER) UL: TC-ER, PLTC-ER, ITC-ER, MTW, WTTCC 1000V, OIL RES I & II, CSA: CIC-TC FT4, AWM I/II A/B FT4

TOPFLEX® 650 VFD

Flexible, extremely oil-resistant motor connection cables with control pair for open installation (ER) UL: TC-ER, PLTC-ER, ITC-ER, MTW, WTTCC 1000V, OIL RES I & II, CSA: CIC-TC FT4, AWM I/II A/B FT4

TRAYCONTROL 610 OIL RES II, WTTCC (2277), FT4

Highly-flexible, extremely oil-resistant motor connection cables for open installation (ER) UL: TC-ER, PLTC-ER, ITC-ER, MTW, WTTCC 1000V, OIL RES I & II, CSA: CIC-TC FT4, AWM I/II A/B FT4

BUS CABLES

PROFINet Typ A UL CMG or PLTC, CSA FT4
PROFINet Typ B UL CMG or PLTC
PROFINet Typ B SHIPLINE UL CMG or PLTC, CSA FT4
PROFINet Typ C UL CMG
Profibus L2 Torsion UL CMX
Profibus L2 Festoon UL CMX, CSA FT4
Profibus SK innen UL CMG, CSA FT4
Profibus SK FRNC UL CM
Profibus SK Schleppkette UL CMX
DeviceNet™PVC dünn UL CMG FT4
DeviceNet™PVC dick UL CMG FT4
Siehe 222



TRAYCONTROL® 300

flexible, oil resistant, NFPA 79



Technical data

- Flexible PVC data and control cable
- **Temperature range**
-25°C to +105°C
- **Nominal voltage**
300 V
- **Test voltage**
2000 V
- **Minimum bending radius**
flexing 6x cable Ø
- **Radiation resistance**
up to 80x10⁶ cJ/kg (up to 80 Mrad)

Cable structure

- Tinned copper conductor, fine wire with AWG dimensions
- Outer sheath of special PVC (AWG 22 -AWG 16 with transparent nylon skin)
- Core identification to international colour code
- Cores stranded in layers with optimal lay length
- Separator
- Outer sheath of special PVC
- Sheath colour: grey (RAL 7001)
- With length marking in feet

Properties

- The materials used during manufacturing are cadmium-free, contain no silicone and are free from substances harmful to the wetting properties of lacquers
- ### Tests
- Self-extinguishing and flame retardant acc. to CSA FT4
 - **UL (AWG 22 - AWG 16):**
PLTC-ER, ITC-ER, Type CM, NFPA 79, OIL RES I & II, Class I Div. 2, NEC Art. 501, 725, 760 & 800, AWM 25 17
 - **UL (AWG 24 - AWG 28):**
CM, AWM 25 17, rated OIL RES I & II, NEC Art. 725, 760 & 800, NFPA 79
 - **CSA:**
CSA CMG FT4, AWM I/II A/B FT4

Note

Advantages

- Highly flexible easy to install
- Oil resistant to OIL RES I & II

Available on request

- PUR or TPE outer sheath
- Sheath colour to suit customer requirements

Application

HELUKABEL® TRAYCONTROL® 300 is a multi-core PVC data and control cable. Cross-sections with PLTC-ER and ITC-ER approval suitable for open, unprotected installation in cable trays to the machine; their outstanding oil resistance (OIL RES I & II) makes them ideally suited as connecting and joining cables and also for control, signal and measuring systems in industrial plants. The flexible cable structure facilitates installation inside and outside of machines and switch cabinets. Applications: tool machines, control panels, control and instrumentation technology, production automation, cable ducts, renewable energies.

CE = Product conforms with Low-Voltage Directive 2014/35/EU.

Part no.	Cross-section mm² x AWG-No.	No. cores	Outer Ø app. mm	Cop. weight kg / km	Weight app. kg / km	Part no.	Cross-section mm² x AWG-No.	No. cores	Outer Ø app. mm	Cop. weight kg / km	Weight app. kg / km
62625	0,093	2 x 28	3,8	1,8	12,0	62655	0,241	15 x 24	7,7	35,0	69,0
62626	0,093	3 x 28	3,9	3,0	18,0	62656	0,241	20 x 24	8,4	46,3	86,0
62627	0,093	4 x 28	4,2	4,0	21,0	62657	0,241	25 x 24	9,1	58,0	103,0
62628	0,093	6 x 28	4,7	5,0	27,0	62658	0,241	30 x 24	9,6	69,4	131,0
62629	0,093	8 x 28	5,0	7,0	30,0	62659	0,241	40 x 24	11,2	92,6	173,0
62630	0,093	10 x 28	5,6	9,0	30,0	62660	0,241	50 x 24	12,4	115,7	219,0
62631	0,093	15 x 28	6,2	13,0	43,0	62661	0,382	2 x 22	6,5	7,0	22,0
62632	0,093	20 x 28	6,8	18,0	54,0	62662	0,382	3 x 22	6,7	11,0	28,0
62633	0,093	25 x 28	7,6	22,0	63,0	62663	0,382	4 x 22	7,2	14,7	32,0
62634	0,093	30 x 28	8,0	27,0	73,0	62664	0,382	6 x 22	8,3	22,0	46,0
62635	0,093	40 x 28	8,8	36,0	89,0	62665	0,382	8 x 22	8,8	29,4	54,0
62636	0,093	50 x 28	9,8	45,0	109,0	62666	0,382	10 x 22	10,1	37,0	66,0
62637	0,154	2 x 26	4,0	3,0	18,0	62667	0,382	15 x 22	11,4	55,0	90,0
62638	0,154	3 x 26	4,2	4,0	21,0	62668	0,382	20 x 22	12,5	73,0	115,0
62639	0,154	4 x 26	4,4	6,0	24,0	62669	0,382	25 x 22	14,6	92,0	141,0
62640	0,154	6 x 26	5,0	9,0	30,0	62670	0,382	30 x 22	15,4	110,0	176,0
62641	0,154	8 x 26	5,3	12,0	34,0	62671	0,382	40 x 22	17,0	147,0	234,0
62642	0,154	10 x 26	6,0	15,0	42,0	62672	0,382	50 x 22	19,0	183,0	293,0
62643	0,154	15 x 26	6,7	22,0	52,0	62673	0,616	2 x 20	6,9	11,9	57,0
62644	0,154	20 x 26	7,5	30,0	67,0	62674	0,616	3 x 20	7,2	17,8	60,0
62645	0,154	25 x 26	8,2	37,0	80,0	62675	0,616	4 x 20	7,8	23,7	73,0
62646	0,154	30 x 26	8,6	44,0	92,0	62676	0,616	6 x 20	9,0	36,0	97,0
62647	0,154	40 x 26	9,5	59,0	116,0	62677	0,616	8 x 20	9,6	47,4	133,0
62648	0,154	50 x 26	11,1	74,0	145,0	62678	0,616	10 x 20	11,0	59,0	143,0
62649	0,241	2 x 24	4,3	5,0	19,0	62679	0,616	15 x 20	12,5	89,0	177,0
62650	0,241	3 x 24	4,5	7,0	22,0	62680	0,616	20 x 20	14,6	118,0	261,0
62651	0,241	4 x 24	4,8	9,0	27,0	62681	0,616	25 x 20	16,0	148,0	353,0
62652	0,241	6 x 24	5,5	14,0	33,0	62682	0,616	30 x 20	16,8	178,0	419,0
62653	0,241	8 x 24	5,8	18,0	42,0	62683	0,616	40 x 20	18,7	237,0	562,0
62654	0,241	10 x 24	6,6	23,2	49,0	62684	0,616	50 x 20	21,0	296,0	699,0

Continuation ▶

TRAYCONTROL® 300

flexible, oil resistant, NFPA 79



Part no.	Cross-section mm ² x AWG-No.	No.cores	Outer Ø app. mm	Cop. weight kg / km	Weight app. kg / km
62685	0,963	2 x 18	7,4	18,5	61,0
62686	0,963	3 x 18	7,7	28,0	64,0
62687	0,963	4 x 18	8,3	37,0	77,0
62688	0,963	6 x 18	9,7	56,0	101,0
62689	0,963	8 x 18	10,4	74,0	142,0
62690	0,963	10 x 18	11,9	92,0	195,0
62691	0,963	15 x 18	13,5	139,0	247,0
62692	0,963	20 x 18	15,8	185,0	328,0
62693	0,963	25 x 18	17,4	231,0	407,0
62694	0,963	30 x 18	18,3	277,0	539,0
62695	0,963	40 x 18	20,4	370,0	717,0
62696	0,963	50 x 18	23,9	462,0	894,0

Part no.	Cross-section mm ² x AWG-No.	No.cores	Outer Ø app. mm	Cop. weight kg / km	Weight app. kg / km
62697	1,31	2 x 16	7,9	25,0	83,0
62698	1,31	3 x 16	8,3	38,0	91,0
62699	1,31	4 x 16	8,9	50,0	109,0
62700	1,31	6 x 16	10,3	76,0	162,0
62702	1,31	8 x 16	11,2	101,0	243,0
62703	1,31	10 x 16	12,9	126,0	267,0
62704	1,31	15 x 16	15,4	189,0	364,0
62705	1,31	20 x 16	17,2	252,0	493,0
62706	1,31	25 x 16	18,8	314,0	608,0
62707	1,31	30 x 16	19,9	377,0	729,0
62708	1,31	40 x 16	23,3	503,0	967,0
62709	1,31	50 x 16	26,1	629,0	1214,0

Dimensions and specifications may be changed without prior notice. (RN02)

TRAYCONTROL® 300-C

flexible, oil resistant, screened, EMC-preferred type, NFPA 79



Technical data

- Flexible screened PVC data and control cable
- **Temperature range**
-25°C to +105°C
- **Nominal voltage**
300 V
- **Test voltage**
2000 V
- **Minimum bending radius**
flexing 6x cable Ø
- **Coupling resistance**
max. 250 Ohm/km
- **Radiation resistance**
up to 80x10⁶ cJ/kg (up to 80 Mrad)

Cable structure

- Tinned copper conductor, fine wire with AWG dimensions
- Core insulation of special PVC (AWG 22 - AWG 16 with transparent nylon skin)
- Core identification to international colour code
- Cores stranded in layers with optimal lay length
- 1. Screen with special aluminium foil
- Drain wire
- 2. Tinned copper braided screen, approx. 85% coverage
- Separator
- Outer sheath of special PVC
- Sheath colour: grey (RAL 7001)
- With length marking in feet

Properties

- The materials used during manufacturing are cadmium-free, contain no silicone and are free from substances harmful to the wetting properties of lacquers
- **Tests**
- Self-extinguishing and flame retardant acc. to CSA FT4
- **UL (AWG 22 - AWG 16):**
PLTC-ER, ITC-ER, Type CM, NFPA 79, OIL RES I & II, Class I Div. 2, NEC Art. 501, 725, 760 & 800, AWM 2517
- **UL (AWG 24 - AWG 28):**
CM, AWM 2517, rated OIL RES I & II, NEC Art. 725, 760 & 800, NFPA 79
- **CSA:**
CSA CMG FT4, AWM I/II A/B FT4

Note

Advantages

- Highly flexible, easy to install
- Oil resistant to OIL RES I & II

Available on request

- PUR or TPE outer sheath
- Sheath colour to suit customer requirement

Application

HELUKABEL® TRAYCONTROL® 300-C is a screened, multi-core PVC data and control cable. Cross-sections with PLTC-ER and ITC-ER approval suitable for open, unprotected installation in cable trays to the machine; their outstanding oil resistance (OIL RES I & II) makes them ideally suited as connecting and joining cables and also for control, signal and measuring systems in industrial plants. The flexible cable structure facilitates installation inside and outside of machines and switch cabinets. The double-screening with aluminium foil (100% coverage) and copper braid (approx. 85% coverage) guarantee superior EMC protection. Applications: tool machines, control panels, measuring devices, production automation, cable ducts, renewable energies.

EMC = Electromagnetic compatibility

To optimize the EMC features we recommend a large round contact of the copper braiding on both ends.

CE = Product conforms with Low-Voltage Directive 2014/35/EU.

Part no.	Cross-section mm² x AWG-No.	No. cores	Outer Ø app. mm	Cop. weight kg / km	Weight app. kg / km
62710	0,093	2 x 28	4,2	6,0	16,0
62711	0,093	3 x 28	4,3	7,0	22,0
62712	0,093	4 x 28	4,6	9,0	27,0
62713	0,093	6 x 28	5,0	12,0	34,0
62714	0,093	8 x 28	5,5	15,0	37,0
62715	0,093	10 x 28	6,0	18,0	43,0
62716	0,093	15 x 28	6,7	24,0	52,0
62717	0,093	20 x 28	7,5	30,0	67,0
62718	0,093	25 x 28	8,1	37,0	79,0
62719	0,093	30 x 28	8,5	43,0	88,0
62720	0,093	40 x 28	9,3	54,0	112,0
62721	0,093	50 x 28	10,7	67,0	131,0
62722	0,154	2 x 26	4,4	9,0	24,0
62723	0,154	3 x 26	4,5	10,0	27,0
62724	0,154	4 x 26	4,8	12,0	31,0
62725	0,154	6 x 26	5,5	16,0	39,0
62726	0,154	8 x 26	5,8	19,0	43,0
62727	0,154	10 x 26	6,5	24,0	51,0
62728	0,154	15 x 26	7,4	31,0	66,0
62729	0,154	20 x 26	8,0	40,0	79,0
62730	0,154	25 x 26	8,7	49,0	92,0
62731	0,154	30 x 26	9,1	57,0	110,0
62732	0,154	40 x 26	10,5	72,0	136,0
62733	0,154	50 x 26	11,6	88,0	165,0

Part no.	Cross-section mm² x AWG-No.	No. cores	Outer Ø app. mm	Cop. weight kg / km	Weight app. kg / km
62734	0,241	2 x 24	4,7	15,0	30,0
62735	0,241	3 x 24	4,9	16,0	33,0
62736	0,241	4 x 24	5,3	19,0	37,0
62737	0,241	6 x 24	6,2	27,0	48,0
62738	0,241	8 x 24	6,6	31,0	57,0
62739	0,241	10 x 24	7,3	39,0	67,0
62740	0,241	15 x 24	8,2	51,0	85,0
62741	0,241	20 x 24	8,8	64,0	106,0
62742	0,241	25 x 24	9,6	77,0	128,0
62743	0,241	30 x 24	10,6	92,0	155,0
62744	0,241	40 x 24	11,6	118,0	206,0
62745	0,241	50 x 24	12,9	148,0	249,0
62746	0,382	2 x 22	6,9	19,0	34,0
62747	0,382	3 x 22	7,2	22,0	40,0
62748	0,382	4 x 22	7,7	27,0	46,0
62749	0,382	6 x 22	8,8	34,0	60,0
62750	0,382	8 x 22	9,3	45,0	72,0
62751	0,382	10 x 22	10,6	69,0	85,0
62752	0,382	15 x 22	11,9	77,0	115,0
62753	0,382	20 x 22	13,0	92,0	140,0
62754	0,382	25 x 22	15,0	121,0	176,0
62755	0,382	30 x 22	15,9	139,0	210,0
62756	0,382	40 x 22	17,7	177,0	273,0
62757	0,382	50 x 22	19,7	215,0	331,0

Continuation ▶

TRAYCONTROL® 300-C

flexible, oil resistant, screened, EMC-preferred type, NFPA 79



Part no.	Cross-section mm² x AWG-No.	No.cores	Outer Ø app. mm	Cop. weight kg / km	Weight app. kg / km
62758	0,616	2 x 20	7,4	28,0	73,0
62759	0,616	3 x 20	7,7	34,0	77,0
62760	0,616	4 x 20	8,3	40,0	91,0
62761	0,616	6 x 20	9,4	54,0	118,0
62762	0,616	8 x 20	10,1	70,0	158,0
62763	0,616	10 x 20	11,5	83,0	173,0
62764	0,616	15 x 20	13,0	119,0	218,0
62765	0,616	20 x 20	15,1	130,0	298,0
62766	0,616	25 x 20	16,5	186,0	401,0
62767	0,616	30 x 20	17,5	224,0	477,0
62768	0,616	40 x 20	19,0	288,0	623,0
62769	0,616	50 x 20	22,6	337,0	752,0
62770	0,963	2 x 18	7,8	37,0	80,0
62771	0,963	3 x 18	8,2	49,0	86,0
62772	0,963	4 x 18	8,8	58,0	101,0
62773	0,963	6 x 18	10,1	82,0	130,0
62774	0,963	8 x 18	10,8	100,0	168,0
62775	0,963	10 x 18	12,4	124,0	226,0

Part no.	Cross-section mm² x AWG-No.	No.cores	Outer Ø app. mm	Cop. weight kg / km	Weight app. kg / km
62776	0,963	15 x 18	14,9	180,0	295,0
62777	0,963	20 x 18	16,3	234,0	386,0
62778	0,963	25 x 18	18,0	277,0	462,0
62779	0,963	30 x 18	18,9	323,0	590,0
62780	0,963	40 x 18	21,2	416,0	773,0
62781	0,963	50 x 18	24,7	508,0	958,0
62782	1,31	2 x 16	8,4	51,0	110,0
62783	1,31	3 x 16	8,7	63,0	116,0
62784	1,31	4 x 16	9,4	76,0	139,0
62785	1,31	6 x 16	10,9	104,0	195,0
62786	1,31	8 x 16	11,7	134,0	283,0
62787	1,31	10 x 16	13,4	168,0	316,0
62788	1,31	15 x 16	16,0	234,0	410,0
62789	1,31	20 x 16	17,8	301,0	551,0
62790	1,31	25 x 16	19,5	367,0	675,0
62791	1,31	30 x 16	20,6	428,0	794,0
62792	1,31	40 x 16	24,0	550,0	1033,0
62793	1,31	50 x 16	26,8	669,0	1274,0

Dimensions and specifications may be changed without prior notice. (RN02)

TRAYCONTROL® 300 TP

twisted pair, flexible, oil resistant, NFPA 79



Technical data

- Flexible PVC data and control cable
- **Temperature range**
-25°C to +105°C
- **Nominal voltage**
300 V
- **Test voltage**
2000 V
- **Minimum bending radius**
flexing 6x cable Ø
- **Radiation resistance**
up to 80x10⁶ cJ/kg (up to 80 Mrad)

Cable structure

- Tinned copper conductor, fine wire stranded, with AWG dimensions
- Core insulation of special PVC (AWG 22 - AWG 18 with transparent nylon skin)
- Core identification (pair) acc. to international colour code
- Cores stranded in pairs with optimal lay length
- Pairs stranded in layers with optimal lay length
- Separator
- Outer sheath of special PVC
- Sheath colour: grey (RAL 7001)
- With length marking in feet

Properties

- The materials used during manufacturing are cadmium-free, contain no silicone and are free from substances harmful to the wetting properties of lacquers
- ### Tests
- Self-extinguishing and flame retardant acc. to CSA FT4
 - **UL (AWG 22 - AWG 18):**
PLTC-ER, ITC-ER, Type CM, NFPA 79, OIL RES I & II, Class I Div. 2, NEC Art. 501, 725, 760 & 800, AWM 2517
 - **UL (AWG 24 - AWG 26):**
CM, AWM 2517, rated OIL RES I & II, NEC Art. 725, 760 & 800, NFPA 79
 - **CSA:**
CSA CMG FT4, AWM I/II A/B FT4

Note

Advantages

- Highly flexible, easy to install
- Oil resistant to OIL RES I & II

Available on request

- PUR or TPE outer sheath
- Sheath colour to suit customer requirement

Application

HELUKABEL® TRAYCONTROL® 300 TP is a twisted pair data and control cable. Cross-sections with PLTC-ER and ITC-ER approval for open, unprotected installation in cable trays to the machine; their outstanding oil resistance (OIL RES I & II) makes them ideally suited as connecting and joining cables and also for control, signal and measuring systems in industrial plants. The flexible cable structure facilitates installation inside and outside of machines and switch cabinets. Applications: tool machines, control panels, measuring devices, production automation, cable ducts, renewable energies.

CE = Product conforms with Low-Voltage Directive 2014/35/EU.

Part no.	Cross-section mm ²	No.pairs x No.cores x AWG-no.	Outer Ø app. mm	Cop. weight kg / km	Weight app. kg / km
62794	0,154	1 x 2 x 26	4,0	3,0	20,0
62795	0,154	2 x 2 x 26	5,2	5,0	24,0
62796	0,154	3 x 2 x 26	5,5	8,0	30,0
62797	0,154	4 x 2 x 26	5,9	11,0	38,0
62798	0,154	5 x 2 x 26	6,4	14,0	44,0
62799	0,154	6 x 2 x 26	6,9	16,0	51,0
62800	0,154	7 x 2 x 26	6,9	19,0	57,0
61928	0,154	8 x 2 x 26	7,6	22,0	64,0
61929	0,154	10 x 2 x 26	8,7	27,0	76,0
61930	0,154	12 x 2 x 26	9,0	33,0	93,0
61931	0,154	14 x 2 x 26	9,4	38,0	103,0
61932	0,154	15 x 2 x 26	10,4	41,0	109,0
61933	0,154	16 x 2 x 26	10,4	43,0	112,0
61934	0,154	18 x 2 x 26	11,0	49,0	119,0
61935	0,154	20 x 2 x 26	11,4	54,0	130,0
61936	0,154	22 x 2 x 26	11,9	59,0	150,0
61937	0,154	24 x 2 x 26	12,5	65,0	169,0
61938	0,154	25 x 2 x 26	12,5	67,0	178,0

Part no.	Cross-section mm ²	No.pairs x No.cores x AWG-no.	Outer Ø app. mm	Cop. weight kg / km	Weight app. kg / km
61939	0,241	1 x 2 x 24	4,3	5,0	32,0
61940	0,241	2 x 2 x 24	5,7	10,0	36,0
61941	0,241	3 x 2 x 24	6,0	15,0	48,0
61942	0,241	4 x 2 x 24	6,5	20,0	56,0
61943	0,241	5 x 2 x 24	7,0	25,0	71,0
61944	0,241	6 x 2 x 24	7,8	29,0	80,0
61945	0,241	7 x 2 x 24	7,8	34,0	89,0
61946	0,241	8 x 2 x 24	8,4	39,0	98,0
61947	0,241	10 x 2 x 24	9,7	49,0	111,0
61948	0,241	12 x 2 x 24	10,6	59,0	135,0
61949	0,241	14 x 2 x 24	11,0	69,0	160,0
61950	0,241	15 x 2 x 24	11,6	74,0	171,0
61951	0,241	16 x 2 x 24	11,6	79,0	185,0
61952	0,241	18 x 2 x 24	12,2	89,0	209,0
61953	0,241	20 x 2 x 24	12,8	98,0	230,0
61954	0,241	22 x 2 x 24	13,3	109,0	248,0
61955	0,241	24 x 2 x 24	14,0	118,0	279,0
61956	0,241	25 x 2 x 24	14,0	124,0	292,0

Continuation ▶

TRAYCONTROL® 300 TP

twisted pair, flexible, oil resistant, NFPA 79



Part no.	Cross-section mm ²	No.pairs x Outer Ø No.cores app. mm x AWG-no.	Cop. weight kg / km	Weight app. kg / km	
61957	0,382	1 x 2 x 22	6,5	7,0	38,0
61958	0,382	2 x 2 x 22	8,8	13,0	44,0
61959	0,382	3 x 2 x 22	9,2	20,0	60,0
61960	0,382	4 x 2 x 22	10,0	29,0	79,0
61961	0,382	5 x 2 x 22	10,9	33,0	92,0
61962	0,382	6 x 2 x 22	11,8	39,0	119,0
61963	0,382	7 x 2 x 22	11,8	46,0	128,0
61964	0,382	8 x 2 x 22	12,7	52,0	139,0
61965	0,382	10 x 2 x 22	15,6	65,0	171,0
61966	0,382	12 x 2 x 22	16,1	78,0	194,0
61967	0,382	14 x 2 x 22	16,9	92,0	222,0
61968	0,382	15 x 2 x 22	17,8	98,0	231,0
61969	0,382	16 x 2 x 22	17,8	105,0	240,0
61970	0,382	18 x 2 x 22	18,6	118,0	264,0
61971	0,382	20 x 2 x 22	19,6	131,0	291,0
61972	0,382	22 x 2 x 22	20,5	144,0	300,0
61973	0,382	24 x 2 x 22	22,7	157,0	359,0
61974	0,382	25 x 2 x 22	22,7	163,0	381,0
61975	0,616	1 x 2 x 20	6,9	11,0	60,0
61976	0,616	2 x 2 x 20	9,6	22,0	80,0
61977	0,616	3 x 2 x 20	10,1	32,0	94,0

Part no.	Cross-section mm ²	No.pairs x Outer Ø No.cores x AWG-no.	Cop. weight kg / km	Weight app. kg / km	
61978	0,616	4 x 2 x 20	10,9	43,0	104,0
61979	0,616	5 x 2 x 20	11,9	54,0	130,0
61980	0,616	6 x 2 x 20	12,9	65,0	151,0
61981	0,616	7 x 2 x 20	12,9	75,0	174,0
61982	0,616	8 x 2 x 20	14,8	86,0	262,0
61983	0,616	10 x 2 x 20	15,9	108,0	298,0
61984	0,616	12 x 2 x 20	17,7	129,0	302,0
61985	0,616	14 x 2 x 20	18,5	151,0	327,0
61986	0,616	15 x 2 x 20	19,5	161,0	370,0
61987	0,616	16 x 2 x 20	19,5	172,0	402,0
61988	0,616	18 x 2 x 20	20,5	194,0	480,0
61989	0,616	20 x 2 x 20	22,0	215,0	551,0
61990	0,616	22 x 2 x 20	23,1	237,0	621,0
61991	0,616	24 x 2 x 20	24,4	258,0	703,0
61992	0,616	25 x 2 x 20	24,4	269,0	721,0
61993	0,963	1 x 2 x 18	7,4	18,0	61,0
61994	0,963	2 x 2 x 18	10,3	36,0	77,0
61995	0,963	3 x 2 x 18	10,8	54,0	103,0
61996	0,963	6 x 2 x 18	14,9	107,0	216,0
61997	0,963	9 x 2 x 18	17,2	162,0	328,0
61998	0,963	15 x 2 x 18	21,3	271,0	542,0

Dimensions and specifications may be changed without prior notice. (RN02)

TRAYCONTROL® 300-C TP

twisted pair, flexible, screened, oil resistant, EMC-preferred type, NFPA 79



Technical data

- Flexible screened PVC data and control cable
- **Temperature range**
-25°C to +105°C
- **Nominal voltage**
300 V
- **Test voltage**
2000 V
- **Minimum bending radius**
flexing 6x cable Ø
- **Coupling resistance**
max. 250 Ohm/km
- **Radiation resistance**
up to 80x10⁶ cJ/kg (up to 80 Mrad)

Cable structure

- Tinned copper conductor, fine wire stranded, with AWG dimensions
- Core insulation of special PVC (AWG 22 - AWG 18 with transparent nylon skin)
- Core identification (pair) acc. to international colour code
- Cores stranded in pairs with optimal lay length
- Pairs stranded in layers with optimal lay length
- 1. Screening with special aluminium foil
- Drain wire
- 2. Tinned copper braided screen, approx. 85% coverage
- Separator
- Outer sheath of special PVC
- Sheath colour: grey (RAL 7001)
- With length marking in feet

Properties

- The materials used during manufacturing are cadmium-free, contain no silicone and are free from substances harmful to the wetting properties of lacquers
- ### Tests
- Self-extinguishing and flame retardant acc. to CSA FT4
 - **UL (AWG 22 - AWG 18):**
PLTC-ER, ITC-ER, CM, NFPA 79, OIL RES I & II, Class I Div. 2, NEC Art. 501, 725, 760 & 800, AWM 2517
 - **UL (AWG 24 - AWG 26):**
CM, AWM 2517, rated OIL RES I & II, NEC Art. 725, 760 & 800, NFPA 79
 - **CSA:**
CSA CMG FT4, AWM I/II A/B FT4

Note

Advantages

- Highly flexible, easy to install
- Oil resistant to OIL RES I & II

Available on request

- PUR or TPE outer sheath
- Sheath colour to suit customer requirement

Application

HELUKABEL® TRAYCONTROL® 300-C TP is a screened, twisted pair data and control cable. Cross-sections with PLTC-ER and ITC-ER approval suitable for open, unprotected installation in cable trays to the machine; their outstanding oil resistance (OIL RES I & II) makes them ideally suited as connecting and joining cables and also for control, signal and measuring systems in industrial plants. The flexible cable structure facilitates installation inside and outside of machines and switch cabinets. The double-screening with aluminium foil (100% coverage) and copper braid (approx. 85% coverage) guarantee superior EMC protection. Applications: tool machines, control panels, measuring devices, production automation, cable ducts, renewable energies.

EMC = Electromagnetic compatibility

To optimize the EMC features we recommend a large round contact of the copper braiding on both ends.

CE = Product conforms with Low-Voltage Directive 2014/35/EU.

Part no.	Cross-section mm ²	No.pairs x No.cores x AWG-no.	Outer Ø app. mm	Cop. weight kg / km	Weight app. kg / km
61999	0,154	1 x 2 x 26	4,4	16,0	32,0
59760	0,154	2 x 2 x 26	5,6	20,0	39,0
59761	0,154	3 x 2 x 26	5,9	24,0	47,0
59762	0,154	4 x 2 x 26	6,3	27,0	55,0
59763	0,154	5 x 2 x 26	6,8	31,0	68,0
59764	0,154	6 x 2 x 26	7,5	50,0	86,0
59765	0,154	7 x 2 x 26	7,5	52,0	92,0
59766	0,154	8 x 2 x 26	8,0	54,0	97,0
59767	0,154	10 x 2 x 26	9,1	60,0	111,0
59768	0,154	12 x 2 x 26	9,4	67,0	141,0
59769	0,154	14 x 2 x 26	10,4	75,0	150,0
59770	0,154	15 x 2 x 26	10,8	77,0	154,0
59771	0,154	16 x 2 x 26	10,8	80,0	155,0
59772	0,154	18 x 2 x 26	11,3	84,0	170,0
59773	0,154	20 x 2 x 26	11,8	98,0	183,0
59774	0,154	22 x 2 x 26	12,3	104,0	207,0
59775	0,154	24 x 2 x 26	13,0	112,0	228,0
59776	0,154	25 x 2 x 26	13,0	114,0	239,0

Part no.	Cross-section mm ²	No.pairs x No.cores x AWG-no.	Outer Ø app. mm	Cop. weight kg / km	Weight app. kg / km
59777	0,241	1 x 2 x 24	4,6	16,0	46,0
59778	0,241	2 x 2 x 24	6,2	27,0	53,0
59779	0,241	3 x 2 x 24	6,5	32,0	65,0
59780	0,241	4 x 2 x 24	7,2	37,0	79,0
59781	0,241	5 x 2 x 24	7,8	55,0	98,0
59782	0,241	6 x 2 x 24	8,3	66,0	114,0
59783	0,241	7 x 2 x 24	8,3	60,0	121,0
59784	0,241	8 x 2 x 24	8,9	74,0	129,0
59785	0,241	10 x 2 x 24	10,8	109,0	152,0
59786	0,241	12 x 2 x 24	11,0	116,0	189,0
59787	0,241	14 x 2 x 24	11,5	121,0	213,0
59788	0,241	15 x 2 x 24	12,1	132,0	225,0
59789	0,241	16 x 2 x 24	12,1	142,0	227,0
59790	0,241	18 x 2 x 24	12,6	147,0	238,0
59791	0,241	20 x 2 x 24	13,2	161,0	270,0
59792	0,241	22 x 2 x 24	13,8	171,0	300,0
59793	0,241	24 x 2 x 24	14,5	230,0	321,0
59794	0,241	25 x 2 x 24	14,5	231,0	340,0

Continuation ▶

TRAYCONTROL® 300-C TP

twisted pair, flexible, screened, oil resistant, EMC-preferred type, NFPA 79



Part no.	Cross-section mm ²	No.pairs x Outer Ø No.cores app. mm x AWG-no.	Cop. weight kg / km	Weight app. kg / km	
59795	0,382	1 x 2 x 22	6,9	17,0	58,0
59796	0,382	2 x 2 x 22	9,3	37,0	65,0
59797	0,382	3 x 2 x 22	9,7	45,0	79,0
59798	0,382	4 x 2 x 22	10,5	54,0	88,0
59799	0,382	5 x 2 x 22	11,4	63,0	110,0
59800	0,382	6 x 2 x 22	12,3	73,0	126,0
59801	0,382	7 x 2 x 22	12,3	79,0	140,0
59802	0,382	8 x 2 x 22	13,2	88,0	148,0
59803	0,382	10 x 2 x 22	15,9	107,0	184,0
59804	0,382	12 x 2 x 22	16,6	122,0	210,0
59805	0,382	14 x 2 x 22	17,4	138,0	241,0
59806	0,382	15 x 2 x 22	18,2	154,0	245,0
59807	0,382	16 x 2 x 22	18,2	161,0	251,0
59808	0,382	18 x 2 x 22	19,1	198,0	275,0
59809	0,382	20 x 2 x 22	20,1	211,0	300,0
59810	0,382	22 x 2 x 22	21,0	218,0	320,0
59811	0,382	24 x 2 x 22	23,1	230,0	371,0
59812	0,382	25 x 2 x 22	23,1	239,0	402,0
59813	0,616	1 x 2 x 20	7,4	26,0	70,0
59814	0,616	2 x 2 x 20	10,0	56,0	89,0
59815	0,616	3 x 2 x 20	10,5	72,0	102,0

Part no.	Cross-section mm ²	No.pairs x Outer Ø No.cores app. mm x AWG-no.	Cop. weight kg / km	Weight app. kg / km	
59816	0,616	4 x 2 x 20	11,4	92,0	119,0
59817	0,616	5 x 2 x 20	12,4	107,0	140,0
59818	0,616	6 x 2 x 20	13,4	122,0	162,0
59819	0,616	7 x 2 x 20	13,4	132,0	198,0
59820	0,616	8 x 2 x 20	15,3	144,0	272,0
59821	0,616	10 x 2 x 20	16,4	180,0	307,0
59822	0,616	12 x 2 x 20	18,3	202,0	318,0
59823	0,616	14 x 2 x 20	19,2	221,0	342,0
59824	0,616	15 x 2 x 20	20,1	232,0	381,0
59825	0,616	16 x 2 x 20	20,1	257,0	417,0
59826	0,616	18 x 2 x 20	21,2	282,0	494,0
59827	0,616	20 x 2 x 20	22,7	307,0	570,0
59828	0,616	22 x 2 x 20	23,8	322,0	643,0
59829	0,616	24 x 2 x 20	25,0	342,0	724,0
59830	0,616	25 x 2 x 20	25,0	361,0	740,0
59831	0,963	1 x 2 x 18	7,8	28,0	104,0
59832	0,963	2 x 2 x 18	10,8	57,0	121,0
59833	0,963	3 x 2 x 18	11,3	75,0	150,0
59834	0,963	6 x 2 x 18	15,4	139,0	328,0
59835	0,963	9 x 2 x 18	17,9	212,0	490,0
59836	0,963	15 x 2 x 18	21,9	358,0	811,0

Dimensions and specifications may be changed without prior notice. (RN02)

TRAYCONTROL® 500

flexible, oil-resistant, open installation TC-ER, PLTC-ER, ITC-ER, NFPA 79



Technical data

- PVC control cable acc. to UL Std. 1277 and UL Std. 2277
- **Temperature range**
flexing -5°C to +90°C
fixed installation -40°C to +90°C
- **Nominal voltage**
TC 600 V
AWM 1000 V
WTTTC 1000 V
- **Test voltage**
3000 V
- **Minimum bending radius**
flexing 4x cable Ø
- **Insulation resistance**
min. 20 MOhm x km
- **Radiation resistance**
up to 80x10⁶ cJ/kg (up to 80 Mrad)

Cable structure

- Bare copper conductor, fine wire with AWG dimensions
- Core insulation of special PVC with transparent nylon skin
- Core identification to DIN VDE 0293 black cores with continuous white numbering
- GN-YE conductor, 3 cores and above in the outer layer
- Cores stranded in layers with optimal lay length
- Separator
- Outer sheath of special PVC
- Sheath colour: grey (RAL 7001)
- With length marking in feet

Properties

- The materials used during manufacturing are cadmium-free, contain no silicone and are free from substances harmful to the wetting properties of lacquers

Tests

- Self-extinguishing and flame retardant acc. to CSA FT4
- **UL:**
TC-ER, PLTC-ER (AWG 18 - AWG 12), ITC-ER (AWG 18 - AWG 12), MTW, NFPA 79, WTTTC 1000 V, DP-1, OIL RES I & II, 90°C dry / 75°C wet, Class 1 Div. 2 per NEC Art. 336, 392, 501, crush impact test acc. to UL 1277
- **CSA:**
c(UL) CIC-TC FT4, CSA AWM I/II A/B FT4

Note

Advantages

- Highly flexible, easy to install

Available on request

- With blue cores (DC)
- With red cores (AC)
- Black or TPE outer sheath

Application

HELUKABEL® TRAYCONTROL® 500 is a flexible, oil-resistant control cable. The special combination of TC-ER, PLTC-ER and ITC-ER allows this cable to be used as a connecting cable for industrial plant and machinery in accordance with NFPA 79. Approved for open, unprotected installation in cable trays to the machine. Its outstanding oil resistance (OIL RES I & II) guarantees a long service life for industrial applications in dry, damp and wet environments. Recommended applications: production lines, bottling plants, machine construction, switch cabinets, conveyor systems, packaging machines, automotive industry.

☑ = Product conforms with Low-Voltage Directive 2014/35/EU.

Part no.	Cross-section mm ²	No. cores x AWG-No.	Outer Ø app. mm	Cop. weight kg / km	Weight app. kg / km
63079	0,507	2 x 20	6,6	9,8	58,0
63080	0,507	3 x 20	7,0	14,6	61,0
63081	0,507	4 x 20	7,5	19,5	76,0
63082	0,507	5 x 20	8,1	24,4	89,0
63083	0,507	7 x 20	8,7	34,1	120,0
63084	0,507	9 x 20	9,8	43,8	201,0
63085	0,507	12 x 20	10,1	58,4	250,0
63086	0,507	18 x 20	12,9	87,6	295,0
63087	0,507	25 x 20	15,7	121,7	362,0
63088	0,963	2 x 18	7,3	18,5	68,0
63089	0,963	3 x 18	7,6	27,8	88,0
63090	0,963	4 x 18	8,2	37,0	98,0
63091	0,963	5 x 18	8,9	46,3	116,0
63092	0,963	7 x 18	9,6	64,8	149,0
63093	0,963	9 x 18	11,0	83,2	186,0
63094	0,963	10 x 18	11,6	92,5	199,0
63095	0,963	12 x 18	12,2	111,0	245,0
63096	0,963	15 x 18	13,5	138,7	292,0

Part no.	Cross-section mm ²	No. cores x AWG-No.	Outer Ø app. mm	Cop. weight kg / km	Weight app. kg / km
63097	0,963	16 x 18	13,6	147,9	306,0
63098	0,963	18 x 18	15,0	166,4	366,0
63099	0,963	19 x 18	15,1	175,7	384,0
63100	0,963	25 x 18	17,4	231,2	451,0
63101	0,963	27 x 18	17,7	249,6	521,0
63102	0,963	34 x 18	19,7	314,4	625,0
63103	0,963	37 x 18	20,1	342,0	684,0
63104	0,963	41 x 18	21,0	379,0	744,0
63105	0,963	50 x 18	24,0	462,3	933,0
63106	0,963	61 x 18	25,2	564,0	1095,0
63107	1,31	2 x 16	7,8	25,2	80,0
63108	1,31	3 x 16	8,2	37,8	86,0
63109	1,31	4 x 16	8,8	50,3	115,0
63110	1,31	5 x 16	9,6	62,9	126,0
63112	1,31	6 x 16	10,2	75,5	164,0
63113	1,31	7 x 16	10,5	88,0	171,0
63114	1,31	8 x 16	11,1	100,7	201,0
63115	1,31	9 x 16	12,0	113,2	237,0

Continuation ▶

TRAYCONTROL® 500

flexible, oil-resistant, open installation TC-ER, PLTC-ER, ITC-ER, NFPA 79



Part no.	Cross-section mm ²	No. cores x AWG-No.	Outer Ø app. mm	Cop. weight kg / km	Weight app. kg / km
63116	1,31	10 x 16	12,4	125,8	259,0
63117	1,31	12 x 16	13,6	151,0	301,0
63118	1,31	14 x 16	14,5	176,1	365,0
63119	1,31	15 x 16	15,2	188,7	379,0
63120	1,31	16 x 16	16,0	201,3	405,0
63121	1,31	18 x 16	16,4	226,4	443,0
63122	1,31	19 x 16	16,6	239,0	458,0
63123	1,31	20 x 16	17,2	251,6	491,0
63124	1,31	25 x 16	18,9	314,5	564,0
63125	1,31	27 x 16	19,3	339,6	629,0
63126	1,31	30 x 16	20,0	377,3	701,0
63127	1,31	34 x 16	22,5	427,6	775,0
63128	1,31	40 x 16	23,5	503,1	946,0
63129	1,31	41 x 16	24,0	515,7	967,0
63130	1,31	50 x 16	26,1	628,8	1137,0
63131	1,31	61 x 16	27,5	767,2	1345,0
63132	2,08	2 x 14	8,9	40,0	100,0
63133	2,08	3 x 14	9,2	60,0	112,0
63111	2,08	4 x 14	10,1	80,0	141,0
63164	2,08	5 x 14	10,9	100,0	152,0
63165	2,08	6 x 14	11,5	120,0	205,0
63166	2,08	7 x 14	12,0	140,0	216,0
63167	2,08	9 x 14	14,7	180,0	312,0
63168	2,08	10 x 14	15,8	200,0	378,0
63169	2,08	12 x 14	16,4	240,0	434,0
63170	2,08	16 x 14	18,0	320,0	550,0
63171	2,08	18 x 14	18,9	359,0	616,0
63172	2,08	19 x 14	19,0	380,0	634,0
63173	2,08	25 x 14	23,0	500,0	817,0
63174	3,31	2 x 12	9,7	63,0	132,0
63175	3,31	3 x 12	10,2	95,0	177,0
63176	3,31	4 x 12	11,2	127,0	201,0
63177	3,31	5 x 12	12,3	159,0	274,0

Part no.	Cross-section mm ²	No. cores x AWG-No.	Outer Ø app. mm	Cop. weight kg / km	Weight app. kg / km
63178	3,31	6 x 12	13,6	191,0	315,0
63179	3,31	7 x 12	13,9	222,0	353,0
63180	3,31	9 x 12	16,4	286,0	476,0
63181	3,31	12 x 12	18,3	381,0	613,0
63182	3,31	16 x 12	19,8	508,0	783,0
63183	3,31	19 x 12	22,3	604,0	918,0
63184	3,31	20 x 12	23,1	636,0	961,0
63185	3,31	25 x 12	25,8	794,0	1236,0
63186	5,26	2 x 10	12,2	101,0	213,0
63187	5,26	3 x 10	12,9	151,5	283,0
63188	5,26	4 x 10	15,0	202,0	387,0
63189	5,26	5 x 10	16,3	252,5	473,0
63190	5,26	7 x 10	17,7	353,5	607,0
63191	5,26	9 x 10	20,6	454,5	771,0
63192	5,26	12 x 10	24,1	606,0	1061,0
63193	5,26	19 x 10	27,2	959,5	1528,0
63194	8,37	3 x 8	17,0	241,1	420,0
63195	8,37	4 x 8	19,2	321,4	662,0
63196	8,37	5 x 8	21,0	401,8	784,0
63197	13,3	3 x 6	19,5	383,1	701,0
63198	13,3	4 x 6	22,4	510,7	908,0
63199	13,3	5 x 6	24,5	638,4	1149,0
62802	21,2	3 x 4	24,4	610,6	1061,0
62803	21,2	4 x 4	27,0	814,1	1366,0
62804	21,2	5 x 4	29,9	1017,6	1631,0
62805	33,6	3 x 2	28,2	967,7	1480,0
62806	33,6	4 x 2	31,4	1290,3	1922,0
62807	33,6	5 x 2	34,6	1612,8	2363,0
62808	42,3	4 x 1	35,6	1624,0	2397,0
62809	52,9	4 x 1/0	38,7	2031,0	2938,0
62810	67,3	4 x 2/0	42,1	2584,0	3559,0
62811	84,4	4 x 3/0	49,4	3256,0	4181,0
62812	106,7	4 x 4/0	52,0	4097,0	5747,0

Dimensions and specifications may be changed without prior notice. (RN01)

TRAYCONTROL® 500-C

flexible, oil-resistant, screened, open installation TC-ER, PLTC-ER, ITC-ER, NFPA 79, EMC-preferred type



Technical data

- PVC control cable acc. to UL Std. 1277 and UL Std. 2277
- **Temperature range**
flexing -5°C to +90°C
fixed installation -40°C to +90°C
- **Nominal voltage**
TC 600 V
AWM 1000 V
WTTC 1000 V
- **Test voltage**
3000 V
- **Coupling resistance**
max. 250 Ohm/km
- **Minimum bending radius**
flexing 6x cable Ø
- **Insulation resistance**
min. 20 MOhm x km
- **Radiation resistance**
up to 80x10⁶ cJ/kg (up to 80 Mrad)

Cable structure

- Bare copper conductor, fine wire with AWG dimensions
- Core insulation of special PVC with transparent nylon skin
- Core identification to DIN VDE 0293 black cores with continuous white numbering
- GN-YE conductor, 3 cores and above in the outer layer
- Cores stranded in layers with optimal lay length
- Separating foil
- Braided screening of tinned copper wires, coverage approx. 85%
- Separator
- Outer sheath of special PVC
- Sheath colour: grey (RAL 7001)
- With length marking in feet

Properties

- The materials used during manufacturing are cadmium-free, contain no silicone and are free from substances harmful to the wetting properties of lacquers
- **Tests**
- Self-extinguishing and flame retardant acc. to CSA FT4
- **UL:**
TC-ER, PLTC-ER (AWG 18 - AWG 12), ITC-ER (AWG 18 - AWG 12), MTW, NFPA 79, WTTC 1000 V, DP-1, OIL RES I & II, 90°C dry / 75°C wet, Class 1 Div. 2 per NEC Art 336, 392, 501, crush impact test acc. to UL 1277
- **CSA:**
c(UL) CIC-TC FT4, CSA AWM I/II A/B FT4

Note

Advantages

- Highly flexible, easy to install

Available on request

- With blue cores (DC)
- With red cores (AC)
- Black or TPE outer sheath

Application

HELUKABEL® TRAYCONTROL® 500-C is a flexible, screened and oil-resistant control cable. The special combination of TC-ER, PLTC-ER and ITC-ER allows this cable to be used as a connecting cable for industrial plant and machinery in accordance with NFPA 79. Approved for open, unprotected installation in cable trays to the machine. Its outstanding oil resistance (OIL RES I & II) guarantees a long service life for industrial applications in dry, damp and wet environments. Recommended applications: production lines, bottling plants, machine construction, switch cabinets, conveyor systems, packaging machines, automotive industry.

EMC = Electromagnetic compatibility

To optimize the EMC features we recommend a large round contact of the copper braiding on both ends.

☑ = Product conforms with Low-Voltage Directive 2014/35/EU.

Part no.	Cross-section mm ²	No. cores x AWG-No.	Outer Ø app. mm	Cop. weight kg / km	Weight app. kg / km	Part no.	Cross-section mm ²	No. cores x AWG-No.	Outer Ø app. mm	Cop. weight kg / km	Weight app. kg / km
62813	0,507	2 x 20	7,0	35,0	95,0	62828	0,963	19 x 18	15,7	280,0	443,0
62814	0,507	3 x 20	7,6	42,0	115,0	62829	0,963	25 x 18	17,7	349,0	571,0
62815	0,507	7 x 20	9,4	69,0	164,0	62830	1,31	3 x 16	8,9	74,0	144,0
62816	0,507	12 x 20	11,0	108,0	266,0	62831	1,31	4 x 16	9,6	90,0	172,0
62817	0,507	25 x 20	16,1	240,0	435,0	62832	1,31	5 x 16	10,3	104,0	188,0
62818	0,963	2 x 18	8,1	50,0	110,0	62833	1,31	6 x 16	10,5	120,0	203,0
62819	0,963	3 x 18	8,2	60,0	118,0	62834	1,31	7 x 16	11,3	134,0	244,0
62820	0,963	4 x 18	8,8	71,0	136,0	62835	1,31	9 x 16	12,6	165,0	308,0
62821	0,963	5 x 18	9,4	88,0	148,0	62836	1,31	10 x 16	12,9	180,0	346,0
62822	0,963	7 x 18	10,1	111,0	192,0	62837	1,31	12 x 16	15,1	244,0	423,0
62823	0,963	9 x 18	11,4	140,0	244,0	62838	1,31	15 x 16	16,4	270,0	441,0
62824	0,963	10 x 18	12,0	150,0	283,0	62839	1,31	18 x 16	17,3	319,0	512,0
62825	0,963	12 x 18	12,9	184,0	329,0	62840	1,31	19 x 16	17,6	327,0	503,0
62826	0,963	15 x 18	14,8	207,0	377,0	62841	1,31	20 x 16	17,5	340,0	524,0
62827	0,963	18 x 18	15,7	260,0	435,0	62842	1,31	25 x 16	19,6	434,0	704,0

Continuation ▶

TRAYCONTROL® 500-C

flexible, oil-resistant, screened, open installation TC-ER, PLTC-ER, ITC-ER, NFPA 79, EMC-preferred type



Part no.	Cross-section mm ²	No. cores x AWG-No.	Outer Ø app. mm	Cop. weight kg / km	Weight app. kg / km
62843	2,08	3 x 14	9,8	112,0	179,0
62844	2,08	4 x 14	10,7	121,0	222,0
62845	2,08	5 x 14	11,6	150,0	266,0
62846	2,08	7 x 14	12,5	200,0	326,0
62847	2,08	9 x 14	15,0	240,0	435,0
62848	2,08	10 x 14	16,3	264,0	427,0
62849	2,08	12 x 14	16,9	350,0	592,0
62850	2,08	15 x 14	18,3	409,0	635,0
62851	2,08	18 x 14	19,5	471,0	780,0
62852	2,08	19 x 14	19,7	505,0	799,0
62853	2,08	25 x 14	23,3	652,0	1042,0
62854	3,31	3 x 12	11,4	137,0	237,0
62855	3,31	4 x 12	12,2	169,0	314,0
62856	3,31	5 x 12	13,4	201,0	386,0
62857	3,31	6 x 12	14,6	236,0	425,0
62858	3,31	7 x 12	15,5	262,0	496,0
62859	3,31	9 x 12	17,7	334,0	740,0

Part no.	Cross-section mm ²	No. cores x AWG-No.	Outer Ø app. mm	Cop. weight kg / km	Weight app. kg / km
62860	3,31	12 x 12	19,7	434,0	887,0
62861	3,31	15 x 12	21,0	531,0	903,0
62862	3,31	19 x 12	23,1	720,0	1123,0
62863	3,31	20 x 12	25,0	764,0	1490,0
62864	3,31	25 x 12	27,1	914,0	1865,0
62865	5,26	3 x 10	14,1	240,0	389,0
62866	5,26	4 x 10	15,5	305,0	549,0
62867	5,26	5 x 10	16,8	399,0	610,0
62868	5,26	7 x 10	18,2	505,0	851,0
62869	5,26	9 x 10	20,9	704,0	1132,0
62870	5,26	12 x 10	24,4	940,0	1523,0
62871	5,26	19 x 10	27,5	1210,0	1952,0
62872	8,37	4 x 8	19,9	535,0	852,0
62873	13,3	4 x 6	23,3	740,0	1202,0
62874	21,2	4 x 4	28,6	1140,0	1971,0
62875	33,6	4 x 2	33,2	1576,0	2887,0

Dimensions and specifications may be changed without prior notice. (RN01)

JZ-604 TC TRAY CABLE

PVC power cable, open installation TC-ER, NFPA 79, 90°C, 600 V, meter marking



Technical data

- PVC power cable to UL Std. 1 277 TRAY CABLE
- **Multinorm**
also conforms to the following standards:
AWM-Style 2587 to UL Std. 758 and CSA C22.2 No 210 I/II A/B 90C 600 V
- **Temperature range**
dry environment
flexing -5°C to +90°C
fixed installation -25°C to +90°C
wet environment
flexing -5°C to +75°C
fixed installation -25°C to +75°C
- **Nominal voltage**
UL 600 V
- **Test voltage**
3000 V
- **Breakdown voltage**
min. 6000 V
- **Minimum bending radius**
7,5x cable Ø
- **Radiation resistance**
up to 80x10⁶ cJ/kg (up to 80 Mrad)

Cable structure

- Bare copper, fine wire conductors, acc. to DIN VDE 0295 cl.5, BS 6360 cl.5 and IEC 60228 cl.5
- Core insulation of special PVC class 12 B acc. to tab. 50.155 UL Std. 1581, type TFF acc. to UL Std. 62 (AWG 20 - AWG 16)
type THHW acc. to UL Std. 83 (≥ AWG 14)
- Core identification to DIN VDE 0293
black cores with continuous white numbering
- GN-YE conductor, 3 cores and above in the outer layer
- Cores stranded in layers with optimal lay length
- Outer sheath of special PVC acc. to UL Std. 1277 tab. 11.2
- Sheath colour: black (RAL 9005)
- With meter marking

Properties

- The materials used during manufacturing are cadmium-free, contain no silicone and are free from substances harmful to the wetting properties of lacquers
- UV resistant

Tests

- Self-extinguishing and flame retardant acc. to CSA FT4
- UL OIL RES I
- Class 1 Div. 2 per NEC Art. 336, 392, 501

Note

- G = with GN-YE conductor
x = without GN-YE conductor (OZ)
- AWG sizes are approximate equivalent values. The actual cross section is in mm².
- Screened analogue type:
JZ-604-FCY TC TRAY CABLE
JZ-604-YCY TC TRAY CABLE

Application

USA NFPA 79 conformant flexible power cables up to 600 V, for all machinery in tool and plant construction, suitable for installation in dry, humid and damp environments, in the open and in pipes. For underground installation and for open, unprotected installation from the cable rack to machines and industrial plants.

☑ = Product conforms with Low-Voltage Directive 2014/35/EU.

Part no.	No. cores x cross-sec. mm ²	AWG-No.	Outer Ø app. mm	Cop. weight kg / km	Weight app. kg / km
69661	2 x 1	18	8,0	19,2	96,0
69662	3 G 1	18	8,4	29,0	112,0
69663	4 G 1	18	9,2	39,0	134,0
69664	5 G 1	18	10,0	48,0	162,0
69665	7 G 1	18	11,7	67,0	212,0
69666	9 G 1	18	12,6	84,0	260,0
69667	10 G 1	18	14,3	96,0	297,0
69668	12 G 1	18	14,7	115,0	374,0
69669	18 G 1	18	17,1	173,0	501,0
69670	25 G 1	18	20,3	240,0	677,0
69671	34 G 1	18	23,7	326,0	976,0
69672	50 G 1	18	27,8	480,0	1268,0
69673	2 x 1,5	16	8,4	29,0	112,0
69674	3 G 1,5	16	8,8	43,0	129,0
69675	4 G 1,5	16	9,6	58,0	155,0
69676	5 G 1,5	16	10,5	72,0	189,0
69677	7 G 1,5	16	12,3	101,0	246,0
69678	8 G 1,5	16	13,3	115,0	265,0
69679	9 G 1,5	16	13,3	130,0	317,0
69680	10 G 1,5	16	15,1	144,0	332,0
69681	12 G 1,5	16	15,6	173,0	384,0
69682	16 G 1,5	16	17,2	230,0	540,0
69683	18 G 1,5	16	18,2	259,0	604,0
69684	25 G 1,5	16	22,7	360,0	885,0
69685	34 G 1,5	16	25,3	489,0	1099,0
69686	41 G 1,5	16	27,0	590,0	1315,0
69687	50 G 1,5	16	27,3	720,0	1524,0
69688	61 G 1,5	16	29,4	878,0	1927,0

Part no.	No. cores x cross-sec. mm ²	AWG-No.	Outer Ø app. mm	Cop. weight kg / km	Weight app. kg / km
69689	2 x 2,5	14	9,4	48,0	148,0
69690	3 G 2,5	14	9,9	72,0	174,0
69691	4 G 2,5	14	10,8	96,0	218,0
69692	5 G 2,5	14	11,8	120,0	257,0
69693	7 G 2,5	14	14,7	168,0	383,0
69694	8 G 2,5	14	16,0	192,0	441,0
69695	9 G 2,5	14	16,0	216,0	468,0
69696	10 G 2,5	14	17,1	240,0	507,0
69697	12 G 2,5	14	17,7	288,0	571,0
69698	18 G 2,5	14	20,8	432,0	857,0
69699	25 G 2,5	14	25,8	600,0	1267,0
69700	3 G 4	12	11,0	115,0	236,0
69701	4 G 4	12	12,0	154,0	289,0
69702	5 G 4	12	13,2	192,0	345,0
69703	7 G 4	12	16,5	269,0	521,0
69704	9 G 4	12	17,8	346,0	710,0
69705	12 G 4	12	19,9	461,0	803,0
69706	18 G 4	12	24,2	691,0	1220,0
69707	3 G 6	10	12,5	173,0	311,0
69708	4 G 6	10	14,5	230,0	413,0
69709	5 G 6	10	15,8	288,0	482,0
69710	7 G 6	10	17,3	403,0	677,0
69711	3 G 10	8	17,2	288,0	582,0
69712	4 G 10	8	18,9	384,0	738,0
69713	5 G 10	8	20,8	480,0	919,0
69714	7 G 10	8	23,7	672,0	1202,0

Continuation ▶

JZ-604 TC TRAY CABLE

PVC power cable, open installation TC-ER, NFPA 79, 90°C, 600 V, meter marking



Part no.	No. cores x cross-sec. mm ²	AWG-No.	Outer Ø app. mm	Cop. weight kg / km	Weight app. kg / km
69715	3 G 16	6	21,0	461,0	937,0
69716	4 G 16	6	23,9	614,0	1225,0
69717	5 G 16	6	26,3	768,0	1508,0
69718	7 G 16	6	28,8	1075,0	1755,0
69719	3 G 25	4	24,9	720,0	1388,0
69720	4 G 25	4	27,4	960,0	1706,0
69721	5 G 25	4	30,3	1200,0	2036,0
69722	7 G 25	4	33,1	1680,0	2650,0
69723	3 G 35	2	27,1	1008,0	1760,0
69724	4 G 35	2	29,8	1344,0	2174,0
69725	5 G 35	2	33,0	1680,0	2716,0
69726	3 G 50	1	33,2	1440,0	2570,0
69727	4 G 50	1	36,7	1920,0	3236,0
69728	5 G 50	1	41,5	2400,0	3969,0

Part no.	No. cores x cross-sec. mm ²	AWG-No.	Outer Ø app. mm	Cop. weight kg / km	Weight app. kg / km
69729	3 G 70	2/0	37,6	2016,0	3304,0
69730	4 G 70	2/0	42,0	2688,0	4154,0
69731	5 G 70	2/0	48,4	3360,0	5427,0
69732	3 G 95	3/0	41,8	2736,0	4230,0
69733	4 G 95	3/0	47,0	3648,0	5562,0
69734	5 G 95	3/0	52,5	4560,0	6945,0
69735	3 G 120	4/0	46,0	3456,0	5490,0
69736	4 G 120	4/0	51,5	4608,0	7032,0
69737	5 G 120	4/0	56,5	5760,0	8488,0
59378	4 G 150	300 kcmil	58,0	5760,0	8000,0
59379	4 G 185	350 kcmil	60,0	7104,0	9000,0

Dimensions and specifications may be changed without prior notice. (RN01)

JZ-604-YCY TC TRAY CABLE

PVC power cable, screened, open installation TC-ER, NFPA 79, 90°C, 600 V, EMC-preferred type, meter marking



Technical data

- PVC power cable, screened to UL Std. 1277 TRAY CABLE
- **Multinorm**
also conforms to the following standards: AWM-Style 2587 to UL Std. 758 and CSA C22.2 No 210 I/II A/B 90°C 600 V
- **Temperature range**
dry environment
flexing -5°C to +90°C
fixed installation -25°C to +90°C
wet environment
flexing -5°C to +75°C
fixed installation -25°C to +75°C
- **Nominal voltage**
UL 600 V
- **Test voltage**
3000 V
- **Breakdown voltage**
min. 6000 V
- **Minimum bending radius**
10x cable Ø
- **Radiation resistance**
up to 80x10⁶ cJ/kg (up to 80 Mrad)
- **Coupling resistance**
max. 250 Ohm/km

Cable structure

- Bare copper, fine wire conductors, acc. to DIN VDE 0295 cl.5, BS 6360 cl.5 and IEC 60228 cl.5
- Core insulation of special PVC class 12 B to tab.50.155 acc. to UL Std.1581 type THHW acc. to UL Std.83
- Core identification to DIN VDE 0293 black cores with continuous white numbering
- GN-YE conductor, 3 cores and above in the outer layer
- Cores stranded in layers with optimal lay length
- PVC-inner sheath acc. to UL Std.1277 tab.11.2
- Tinned copper braided screening, approx. 85% coverage
- Outer sheath of special PVC acc. to UL Std.1277 tab.11.2,
- Sheath colour: black (RAL 9005)
- With meter marking

Properties

- The materials used during manufacturing are cadmium-free, contain no silicone and are free from substances harmful to the wetting properties of lacquers
- UV resistant
- **Tests**
- Self-extinguishing and flame retardant acc. to CSA FT4
- UL OIL RES I
- Class 1 Div. 2 per NEC Art. 336, 392, 501

Note

- G = with GN-YE conductor
x = without GN-YE conductor (OZ)
- AWG sizes are approximate equivalent values. The actual cross section is in mm².
- Unscreened analogue type:
JZ 604 TC TRAY CABLE

Application

USA NFPA 79 conformant flexible power cables up to 600 V, for all machinery in tool and plant construction, suitable for installation in dry, humid and damp environments, in the open and in pipes. For underground installation and for open, unprotected installation from the cable rack to machines and industrial plants.

EMC = Electromagnetic compatibility

To optimize the EMC features we recommend a large round contact of the copper braiding on both ends.

= Product conforms with Low-Voltage Directive 2014/35/EU.

Part no.	No. cores x cross-sec. mm ²	AWG-No.	Outer Ø app. mm	Cop. weight kg / km	Weight app. kg / km
69804	3 G 16	6	25,2	653,0	1060,0
69805	4 G 16	6	27,8	807,0	1572,0
69806	5 G 16	6	31,2	940,0	2002,0
69807	7 G 16	6	34,5	1345,0	2604,0
69808	3 G 25	4	29,0	920,0	1955,0
69809	4 G 25	4	32,4	1169,0	2218,0
69810	5 G 25	4	36,4	1420,0	2757,0
69811	7 G 25	4	40,3	1921,0	3523,0
69812	3 G 35	2	32,4	1250,0	2289,0
69813	4 G 35	2	36,2	1680,0	2926,0
69814	5 G 35	2	40,5	2020,0	3545,0
69815	3 G 50	1	40,4	1887,0	3379,0

Part no.	No. cores x cross-sec. mm ²	AWG-No.	Outer Ø app. mm	Cop. weight kg / km	Weight app. kg / km
69816	4 G 50	1	45,5	2370,0	4439,0
69817	5 G 50	1	50,0	2880,0	5312,0
69818	3 G 70	2/0	46,7	2516,0	4557,0
69819	4 G 70	2/0	51,1	3257,0	5632,0
69820	5 G 70	2/0	56,0	4032,0	6681,0
69821	3 G 95	3/0	50,1	3086,0	5612,0
69822	4 G 95	3/0	55,0	4060,0	6820,0
69823	5 G 95	3/0	60,5	5244,0	8172,0
69824	3 G 120	4/0	54,0	4176,0	6711,0
69825	4 G 120	4/0	59,5	5231,0	8256,0
69826	5 G 120	4/0	64,5	6624,0	10233,0

Dimensions and specifications may be changed without prior notice. (RN01)

TRAYCONTROL® 600

flexible, oil resistant, open installation TC-ER, PLTC-ER, ITC-ER, NFPA 79



Technical data

- PVC power cable acc. to UL Std. 1277 and UL Std. 2277
- **Temperature range**
UL/CSA TC -40°C to +90°C
UL/AWM -40°C to +90°C
- **Nominal voltage**
TC 600 V
AWM 1000 V
WTTTC 1000 V
- **Test voltage**
3000 V
- **Minimum bending radius**
5x cable Ø
- **Insulation resistance**
min. 20 MOhm x km
- **Radiation resistance**
up to 80x10⁶ cJ/kg (up to 80 Mrad)

Cable structure

- Bare copper conductor, fine wire with AWG dimensions
- Core insulation of special PVC with transparent nylon skin
- Core identification to DIN VDE 0293 black cores with continuous white numbering
- GN-YE conductor, 3 cores and above in the outer layer
- Cores stranded in layers with optimal lay length
- Separator
- Outer sheath of special PVC
- Sheath colour: black (RAL 9005)
- With length marking in feet

Properties

- The materials used during manufacturing are cadmium-free, contain no silicone and are free from substances harmful to the wetting properties of lacquers
- UV resistant
- **Tests**
- Self-extinguishing and flame retardant acc. to CSA FT4
- **UL:**
TC-ER, PLTC-ER (AWG 18 - AWG 12), ITC-ER (AWG 18 - AWG 12), UL Type WTTTC, UL Type MTW, NFPA 79, Oil Res I (Oil Res II also available), 90° C dry / 75° C wet, Class 1 Div. 2 per NEC Art. 336, 392, 501
- **CSA:**
c(UL) CIC-TC FT4, CSA AWM I/II A/B FT4

Note

Advantages

- TC-ER, Tray Cable Exposed Run
- Simple installation
- Outstanding flexibility

Application

NFPA 79 conformant flexible power cable up to 600 V (WTTTC 1000 V), for all machinery in plant construction. Suitable for installation in dry, humid and damp environments, outdoors and pipes. For underground installation and for open, unprotected installation from the cable rack to machines in industrial plants.

CE = Product conforms with Low-Voltage Directive 2014/35/EU.

Part no.	Cross-section mm ²	No. cores x AWG-No.	Outer Ø app. mm	Cop. weight kg / km	Weight app. kg / km
62020	0,507	2 x 20	6,6	9,8	60,0
62021	0,507	3 x 20	7,0	14,6	64,0
62022	0,507	4 x 20	7,5	19,5	79,0
62023	0,507	5 x 20	8,1	24,4	92,0
62024	0,507	7 x 20	8,7	34,1	124,0
62025	0,507	9 x 20	9,8	43,8	210,0
62026	0,507	12 x 20	10,1	58,4	263,0
62027	0,507	18 x 20	12,9	87,6	305,0
62028	0,507	25 x 20	15,7	121,7	371,0
62902	0,963	2 x 18	7,3	18,5	68,0
62903	0,963	3 x 18	7,6	27,8	68,0
62904	0,963	4 x 18	8,2	37,0	97,0
62905	0,963	5 x 18	8,9	46,3	116,0
62906	0,963	7 x 18	9,6	64,8	147,0
62907	0,963	9 x 18	11,0	83,2	186,0
62908	0,963	10 x 18	11,6	92,5	199,0
62909	0,963	12 x 18	12,2	111,0	250,0
62910	0,963	15 x 18	13,5	138,7	292,0
62911	0,963	16 x 18	13,6	147,9	306,0
62912	0,963	18 x 18	15,0	166,4	365,0
62913	0,963	19 x 18	15,1	175,7	384,0
62914	0,963	25 x 18	17,4	231,2	480,0
62915	0,963	27 x 18	17,7	249,6	521,0
62916	0,963	34 x 18	19,7	314,4	625,0
62917	0,963	37 x 18	20,1	342,0	684,0
62918	0,963	41 x 18	21,0	379,0	744,0
62919	0,963	50 x 18	24,0	462,3	933,0
62920	0,963	61 x 18	25,2	564,0	1095,0
62921	1,31	2 x 16	7,8	25,2	80,0
62922	1,31	3 x 16	8,2	37,8	86,0

Part no.	Cross-section mm ²	No. cores x AWG-No.	Outer Ø app. mm	Cop. weight kg / km	Weight app. kg / km
62923	1,31	4 x 16	8,8	50,3	120,0
62924	1,31	5 x 16	9,6	62,9	130,0
62925	1,31	6 x 16	10,2	75,5	164,0
62926	1,31	7 x 16	10,5	88,0	188,0
62927	1,31	8 x 16	11,1	100,7	201,0
62928	1,31	9 x 16	12,0	113,2	238,0
62929	1,31	10 x 16	12,4	125,8	259,0
62930	1,31	12 x 16	13,6	151,0	301,0
62931	1,31	14 x 16	14,5	176,1	356,0
62932	1,31	15 x 16	15,2	188,7	379,0
62933	1,31	16 x 16	16,0	201,3	405,0
62934	1,31	18 x 16	16,4	226,4	430,0
62935	1,31	19 x 16	16,6	239,0	450,0
62936	1,31	20 x 16	17,2	251,6	481,0
62937	1,31	25 x 16	18,9	314,5	564,0
62938	1,31	27 x 16	19,3	339,6	629,0
62939	1,31	30 x 16	20,0	377,3	701,0
62940	1,31	34 x 16	22,5	427,6	775,0
62941	1,31	40 x 16	23,5	503,1	946,0
62942	1,31	41 x 16	24,0	515,7	967,0
62943	1,31	50 x 16	26,1	628,8	1137,0
62944	1,31	61 x 16	27,5	767,2	1345,0
62945	2,08	2 x 14	8,9	40,0	100,0
62946	2,08	3 x 14	9,2	60,0	117,0
62947	2,08	4 x 14	10,1	80,0	141,0
62948	2,08	5 x 14	10,9	100,0	152,0
62949	2,08	6 x 14	11,5	120,0	216,0
62950	2,08	7 x 14	12,0	140,0	255,0
62951	2,08	9 x 14	14,7	180,0	312,0
62952	2,08	10 x 14	15,8	200,0	378,0

Continuation ▶

TRAYCONTROL® 600

flexible, oil resistant, open installation TC-ER, PLTC-ER, ITC-ER, NFPA 79



Part no.	Cross-section mm ²	No. cores x AWG-No.	Outer Ø app. mm	Cop. weight kg / km	Weight app. kg / km
62953	2,08	12 x 14	16,4	240,0	434,0
62954	2,08	16 x 14	18,0	320,0	550,0
62955	2,08	18 x 14	18,9	359,0	616,0
62956	2,08	19 x 14	19,0	380,0	634,0
62957	2,08	25 x 14	23,0	500,0	817,0
62958	3,31	2 x 12	9,7	63,0	132,0
62959	3,31	3 x 12	10,2	95,0	177,0
62960	3,31	4 x 12	11,2	127,0	201,0
62961	3,31	5 x 12	12,3	159,0	274,0
62962	3,31	6 x 12	13,6	191,0	315,0
62963	3,31	7 x 12	13,9	222,0	353,0
62964	3,31	9 x 12	16,4	286,0	476,0
62965	3,31	12 x 12	18,3	381,0	613,0
62966	3,31	16 x 12	19,8	508,0	783,0
62967	3,31	19 x 12	22,3	604,0	918,0
62968	3,31	20 x 12	23,1	636,0	916,0
62969	3,31	25 x 12	25,8	794,0	1286,0
62970	5,26	2 x 10	12,2	101,0	213,0
62971	5,26	3 x 10	12,9	151,5	283,0
62972	5,26	4 x 10	15,0	202,0	387,0
62973	5,26	5 x 10	16,3	252,5	473,0
62974	5,26	7 x 10	17,7	353,5	607,0

Part no.	Cross-section mm ²	No. cores x AWG-No.	Outer Ø app. mm	Cop. weight kg / km	Weight app. kg / km
62975	5,26	9 x 10	20,6	454,5	771,0
62976	5,26	12 x 10	24,1	606,0	1061,0
62977	5,26	19 x 10	27,2	959,5	1528,0
62978	8,37	4 x 8	19,2	321,4	615,0
62979	8,37	5 x 8	21,0	401,8	768,0
62980	13,3	3 x 6	19,5	383,1	700,0
62981	13,3	4 x 6	22,4	510,7	907,0
62982	13,3	5 x 6	24,5	638,4	1100,0
62983	21,2	3 x 4	24,4	610,6	1061,0
62984	21,2	4 x 4	27,0	814,1	1366,0
62985	21,2	5 x 4	29,9	1017,6	1631,0
62986	33,6	3 x 2	28,2	967,7	1480,0
62987	33,6	4 x 2	31,4	1290,3	1922,0
62988	33,6	5 x 2	34,6	1612,8	2360,0
62989	42,3	4 x 1	35,6	1624,0	2397,0
62990	52,9	4 x 1/0	38,7	2031,0	2938,0
62991	67,3	4 x 2/0	42,1	2584,0	3569,0
62992	84,4	4 x 3/0	49,4	3256,0	4181,0
62993	106,7	4 x 4/0	52,0	4097,0	5747,0
62994	128,4	4 x 250 kcmil	55,8	4931,0	7591,0
62995	181,9	4 x 350 kcmil	64,3	6985,0	8299,0
62996	257,6	4 x 500 kcmil	74,1	9892,0	11549,0

Dimensions and specifications may be changed without prior notice. (RN01)

TRAYCONTROL® 600-C

flexible, oil resistant, screened, open installation (TC-ER), NFPA 79,
EMC-preferred type



Technical data

- PVC power cable acc. to UL Std.1277 and UL Std.2277
- **Temperature range**
UL/CSA TC -40°C to +90°C
AWM -40°C to +90°C
- **Nominal voltage**
TC 600 V
AWM 1000 V
WTTTC 1000 V
- **Test voltage**
3000 V
- **Coupling resistance**
max. 250 Ohm/km
- **Minimum bending radius**
6x cable Ø
- **Insulation resistance**
min. 20 MOhm x km
- **Radiation resistance**
up to 80x10⁶ cJ/kg (up to 80 Mrad)

Cable structure

- Bare copper conductor, fine wire with AWG dimensions
- Core insulation of special PVC with transparent nylon skin
- Core identification to DIN VDE 0293 black cores with continuous white numbering
- GN-YE conductor, 3 cores and above in the outer layer
- Cores stranded in layers with optimal lay length
- Separating foil
- Braided screening of tinned copper wires, coverage approx. 85%
- Separator
- Outer sheath of special PVC
- Sheath colour: black (RAL 9005)
- With length marking in feet

Properties

- The materials used during manufacturing are cadmium-free, contain no silicone and are free from substances harmful to the wetting properties of lacquers
- UV resistant

Tests

- Self-extinguishing and flame retardant acc. to CSA FT4
- **UL:**
TC-ER, PLTC-ER (AWG 18 - AWG 12), ITC-ER (AWG 18 - AWG 12), UL Type WTTTC, UL Type MTW
NFPA 79, Oil Res I (Oil Res II also available), 90°C dry / 75°C wet, Class 1 Div. 2 per NEC Art. 336, 392, 501
- **CSA:**
c (UL) CIC-TC FT4, CSA AWM I/II A/B FT4

Note

Advantages

- TC-ER, Tray Cable Exposed Run
- Simple installation
- Outstanding flexibility

Application

USA NFPA 79 compliant, screened, flexible power cable to 600 V (WTTTC 1000 V), for all tool and plant construction machinery, suitable for installation in dry, damp and wet environments, outdoors and in pipes. For underground installation and for open, unprotected installation from the cable tray to the machine and industrial plants.

EMC = Electromagnetic compatibility

To optimize the EMC features we recommend a large round contact of the copper braiding on both ends.

CE = Product conforms with Low-Voltage Directive 2014/35/EU.

Part no.	Cross-section mm ²	No. cores x AWG-No.	Outer Ø app. mm	Cop. weight kg / km	Weight app. kg / km
63049	0,963	3 x 18	8,2	31,0	118,0
63050	0,963	4 x 18	8,8	52,0	136,0
63051	0,963	5 x 18	9,4	62,0	149,0
63052	0,963	7 x 18	10,1	83,0	193,0
63053	0,963	12 x 18	12,9	143,0	328,0
63054	0,963	18 x 18	15,7	207,0	431,0
63055	0,963	25 x 18	17,7	284,0	569,0
62997	1,31	3 x 16	8,9	57,0	144,0
63056	1,31	4 x 16	9,6	72,0	172,0
63057	1,31	5 x 16	10,3	84,0	186,0
63058	1,31	7 x 16	11,3	124,0	243,0
63059	1,31	12 x 16	15,1	199,0	421,0
63060	1,31	18 x 16	17,3	290,0	510,0
63061	1,31	25 x 16	19,6	384,0	704,0
63062	2,08	3 x 14	9,8	85,0	178,0
63063	2,08	4 x 14	10,7	115,0	220,0

Part no.	Cross-section mm ²	No. cores x AWG-No.	Outer Ø app. mm	Cop. weight kg / km	Weight app. kg / km
63064	2,08	5 x 14	11,6	139,0	264,0
63065	2,08	7 x 14	12,5	185,0	325,0
63066	2,08	12 x 14	16,9	309,0	591,0
63067	2,08	18 x 14	19,5	448,0	780,0
63068	2,08	25 x 14	23,3	632,0	1041,0
63069	3,31	4 x 12	12,2	179,0	313,0
63070	3,31	5 x 12	13,4	223,0	384,0
63071	3,31	7 x 12	15,5	298,0	492,0
63072	5,26	4 x 10	15,5	256,0	547,0
63073	5,26	5 x 10	16,8	312,0	608,0
63074	5,26	7 x 10	18,2	430,0	850,0
63075	8,37	4 x 8	19,9	426,0	851,0
63076	13,3	4 x 6	23,3	657,0	1197,0
63077	21,2	4 x 4	28,6	1026,0	1970,0
63078	33,6	4 x 2	33,2	1412,0	2874,0

Dimensions and specifications may be changed without prior notice. (RN01)

TRAYCONTROL 610 OIL RES II

WTTC (2277) UL 1277 FT4

TRAY CABLE for open installation (TC-ER), NFPA 79

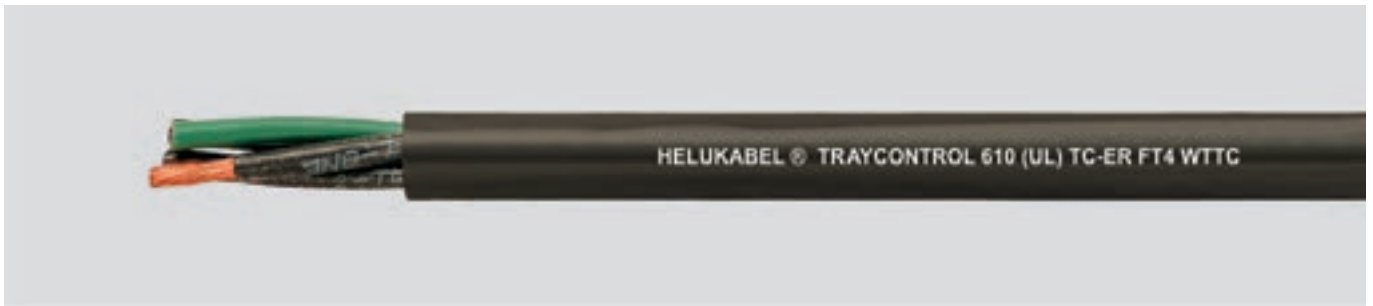

Technical data

- Special power cable acc. to UL 1277; WTTC (2277)
- **Temperature range**
UL/CSA TC -40°C to +90°C
UL/AWM -40°C to +90°C
- **Nominal voltage**
TC 600 V
AWM 1000 V
WTTC 1000 V
- **Test voltage**
3000 V
- **Minimum bending radius**
5x cable Ø
- **Insulation resistance**
min. 20 MOhm x km
- **Radiation resistance**
up to 80x10⁶ cJ/kg (up to 80 Mrad)

Cable structure

- Bare copper conductors, fine wire stranded to DIN VDE 0295 cl.5, BS 6360 cl.5 and IEC 60228 cl.5 with AWG dimensions
- Core insulation of special PVC with transparent Nylon skin
- Core identification black with numbers + gnye (JZ)
G = with GN-YE conductor (JZ)
X = without ground (OZ)
- Multiconductor conductors stranded
- Separator
- Special compound blend outer sheath
- Sheath colour: black
- With length marking in feet

Properties

- The materials used during manufacturing are cadmium-free, contain no silicone and are free from substances harmful to the wetting properties of lacquers
- UV resistant

Tests

- Self-extinguishing and flame retardant acc. to CSA FT4
- **UL:**
Oil Res I/II, Class 1,
Div. 2 per NEC Art. 336, 392, 501
UL Type 2277 (WTTC), TC-ER,
PLTC-ER (AWG 18 - AWG 12),
ITC-ER (AWG 18 - AWG 12), UL 1277 (TC),
UL Type MTW or Type AWM, NFPA 79,
90° C dry / 75° C wet

CSA:

c(UL) Type TC & CIC FT4,
CSA AWM I/II A/B FT4

Note

Advantages:

- TC-ER rated
- Meets TC (UL 1277) & WTTC (UL 2277)

Requirements:

- Simple installation
 - Outstanding flexibility
 - Exceptional abrasion resistance
 - Oil Res I/II approved
 - Torsion resistant for Wind Power application
- For more information, especially on custom cables, please contact us:
wind@helukabel.de

Application

USA NFPA 79 compliant flexible power cables to 600 V (WTTC 1000 V) for all wind energy, tool and plant construction machinery applications. Suitable for installation in dry, damp and wet environments, outdoors and in pipes. For underground installation and for open, unprotected installation from the cable rack to machines and industrial plants.

☑ = Product conforms with Low-Voltage Directive 2014/35/EU.

Continuation ▶

TRAYCONTROL 610 OIL RES II

WTTT (2277) UL 1277 FT4

TRAY CABLE for open installation (TC-ER), NFPA 79



Part no.	No. cores x cross-sec. mm ²	AWG-No.	Outer Ø app. mm	Cop. weight kg / km	Weight app. kg / km
706194	2 G 1	18	7,0	19,0	68,0
706195	3 G 1	18	7,3	29,0	88,0
706196	4 G 1	18	8,0	39,0	98,0
706197	5 G 1	18	8,6	48,0	116,0
706198	7 G 1	18	10,0	67,0	149,0
706199	9 G 1	18	10,7	86,0	186,0
706200	10 G 1	18	11,6	96,0	199,0
706201	12 G 1	18	11,8	115,0	245,0
706202	15 G 1	18	13,2	144,0	292,0
706203	16 G 1	18	13,3	154,0	306,0
706204	18 G 1	18	13,9	173,0	366,0
706205	19 G 1	18	14,7	182,0	384,0
706206	25 G 1	18	17,0	240,0	451,0
706207	27 G 1	18	17,4	259,0	521,0
706208	34 G 1	18	19,3	326,0	625,0
706209	37 G 1	18	19,8	355,0	684,0
706210	41 G 1	18	20,7	384,0	744,0
706211	50 G 1	18	23,5	480,0	933,0
706212	61 G 1	18	24,9	586,0	1095,0
706213	2 G 1,32	16	7,5	25,0	80,0
706214	3 G 1,32	16	8,0	38,0	86,0
706215	4 G 1,32	16	8,9	51,0	115,0
706216	5 G 1,32	16	9,7	63,0	126,0
706217	6 G 1,32	16	10,0	76,0	164,0
706218	7 G 1,32	16	12,0	89,0	171,0
706219	8 G 1,32	16	10,9	101,0	201,0
706220	9 G 1,32	16	11,7	114,0	237,0
706221	10 G 1,32	16	12,4	127,0	259,0
706222	12 G 1,32	16	14,3	152,0	301,0
706223	14 G 1,32	16	14,5	177,0	365,0
706224	15 G 1,32	16	15,0	190,0	379,0
706225	16 G 1,32	16	15,2	203,0	405,0
706226	18 G 1,32	16	16,8	228,0	443,0
706227	19 G 1,32	16	16,0	241,0	458,0
706228	20 G 1,32	16	16,5	253,0	491,0
706229	25 G 1,32	16	18,6	317,0	564,0
706230	27 G 1,32	16	19,0	342,0	629,0
706231	30 G 1,32	16	19,6	380,0	701,0
706232	34 G 1,32	16	20,5	420,0	775,0
706233	40 G 1,32	16	22,9	482,0	946,0
706234	41 G 1,32	16	23,4	513,0	967,0
706235	50 G 1,32	16	25,1	626,0	1137,0
706236	61 G 1,32	16	27,2	762,0	1345,0
706237	2 G 2,08	14	8,6	40,0	100,0
706238	3 G 2,08	14	10,0	60,0	112,0
706239	4 G 2,08	14	10,5	80,0	141,0
706240	5 G 2,08	14	10,9	100,0	152,0
706241	6 G 2,08	14	11,6	120,0	205,0
706242	9 G 2,08	14	13,5	180,0	312,0
706243	10 G 2,08	14	15,5	200,0	378,0
706244	12 G 2,08	14	15,9	240,0	434,0
706245	16 G 2,08	14	17,6	319,0	550,0
706246	18 G 2,08	14	18,3	359,0	616,0
706247	19 G 2,08	14	18,5	380,0	634,0
706248	25 G 2,08	14	21,6	500,0	817,0

Part no.	No. cores x cross-sec. mm ²	AWG-No.	Outer Ø app. mm	Cop. weight kg / km	Weight app. kg / km
706249	2 G 3,31	12	9,5	63,0	132,0
706250	3 G 3,31	12	10,8	95,0	177,0
706251	4 G 3,31	12	12,0	127,0	201,0
706252	5 G 3,31	12	13,6	159,0	274,0
706253	6 G 3,31	12	13,0	191,0	315,0
706254	7 G 3,31	12	15,9	222,0	353,0
706255	9 G 3,31	12	15,9	286,0	476,0
706256	12 G 3,31	12	17,8	381,0	613,0
706257	16 G 3,31	12	19,8	508,0	783,0
706258	19 G 3,31	12	20,8	604,0	918,0
706259	20 G 3,31	12	21,9	636,0	961,0
706260	25 G 3,31	12	25,3	794,0	1236,0
706261	2 G 6	10	11,9	115,0	213,0
706262	3 G 6	10	13,1	173,0	283,0
706263	4 G 6	10	14,7	230,0	387,0
706264	5 G 6	10	16,3	288,0	473,0
706265	7 G 6	10	19,6	403,0	607,0
706266	9 G 6	10	20,4	518,0	771,0
706267	12 G 6	10	23,9	691,0	1061,0
706268	19 G 6	10	27,9	1094,0	1528,0
706269	4 G 10	8	17,4	384,0	662,0
706270	5 G 10	8	20,1	480,0	784,0
706271	3 G 16	6	18,5	461,0	701,0
706272	4 G 16	6	20,7	614,0	908,0
706273	5 G 16	6	25,8	768,0	1149,0
706274	3 G 25	4	24,3	720,0	1060,0
706275	4 G 25	4	26,5	960,0	1366,0
706276	5 G 25	4	28,2	1200,0	1631,0
706277	3 G 35	2	27,9	1008,0	1480,0
706278	4 G 35	2	31,4	1344,0	1922,0
706279	5 G 35	2	35,4	1680,0	2363,0
706280	4 G 42,3	1	34,1	360,0	2397,0
706281	4 G 52,9	1/0	37,9	441,0	2938,0
706282	4 G 67,3	2/0	41,3	584,0	3559,0
706283	4 G 84,8	3/0	48,6	741,0	4181,0
706284	4 G 106,7	4/0	51,2	932,0	5747,0
706285	4 G 128,4	250 kcmil	55,0	4931,0	7591,0
706286	4 G 181,9	350 kcmil	63,5	6985,0	8299,0
706287	4 G 257,6	500 kcmil	73,7	9892,0	10549,0

Dimensions and specifications may be changed without prior notice.

MULTIFLEX 600

highly flexible, oil resistant, open installation TC-ER, PLTC-ER, NFPA 79



Technical data

- Highly flexible PVC control cable acc. to UL Std.1277
- **Temperature range**
flexing -5°C to +90°C
fixed installation -40°C to +90°C
- **Nominal voltage**
TC 600 V
WTTC 1000 V
- **Test voltage**
3000 V
- **Minimum bending radius**
flexing 7,5x cable Ø
- **Insulation resistance**
min. 20 MOhm x km
- **Radiation resistance**
up to 80x10⁶ cJ/kg (up to 80 Mrad)

Cable structure

- Bare copper conductor, extra fine wire stranded, with AWG dimensions
- Core insulation of special PVC with transparent nylon skin
- Core identification to DIN VDE 0293 black cores with continuous white numbering
- GN-YE conductor, 3 cores and above in the outer layer
- Cores stranded in layers with optimal lay length
- Separator
- Outer sheath of special PVC
- Sheath colour: black (RAL 9005)
- With length marking in feet

Properties

- The materials used during manufacturing are cadmium-free, contain no silicone and are free from substances harmful to the wetting properties of lacquers
- UV resistant
- **Tests**
- Self-extinguishing and flame retardant acc. to CSA FT4
- **UL:**
TC-ER, PLTC-ER (AWG 18 - AWG 12), ITC-ER (AWG 18 - AWG 12), MTW, NFPA 79, WTTC 1000 V, DP-1, OIL RES I&II, 90°C dry / 75°C wet, Class 1 Div. 2 per NEC Art 336, 392, 501, crush impact test acc. to UL 1277
- **CSA:**
c(UL) CIC-TC FT4, CSA AWM I/II A/B FT4

Note

Advantages

- Highly flexible, simple installation

Available on request

- With blue cores (DC)
- With red cores (AC)
- Grey or TPE outer sheath

Application

HELUKABEL® MULTIFLEX 600 is a highly flexible, oil resistant control cable. The special combination of TC-ER, PLTC-ER and ITC-ER allows this cable to be used as a connecting cable for industrial plant and machinery in accordance with NFPA 79. Approved for open, unprotected installation in cable trays to the machine. Its outstanding oil resistance (OIL RES I & II) guarantees a long service life; for industrial applications in dry, damp and wet environments. Recommended applications: production lines, bottling plants, machine construction, switch cabinets, conveyor systems, packaging machines, automotive industry. Please observe applicable installation regulations for use in energy supply chains.

☑ = Product conforms with Low-Voltage Directive 2014/35/EU.

Part no.	No. cores x cross-sec. mm ²	AWG-No.	Outer Ø app. mm	Cop. weight kg / km	Weight app. kg / km
62502	2 x 0,5	20	6,9	10,0	53,0
62503	3 G 0,5	20	7,3	14,0	61,0
62504	4 G 0,5	20	8,0	19,0	72,0
62505	5 G 0,5	20	8,6	24,0	85,0
62506	7 G 0,5	20	9,9	34,0	110,0
62507	12 G 0,5	20	11,4	58,0	158,0
62508	18 G 0,5	20	14,2	86,0	241,0
62509	25 G 0,5	20	17,0	120,0	316,0
62510	34 G 0,5	20	18,9	163,0	439,0
62511	3 G 0,75	18	7,8	22,0	75,0
62512	4 G 0,75	18	8,6	29,0	91,0
62513	5 G 0,75	18	9,3	36,0	103,0
62514	7 G 0,75	18	10,8	50,0	136,0
62515	12 G 0,75	18	12,4	86,0	228,0
62516	15 G 0,75	18	13,8	108,0	273,0
62517	18 G 0,75	18	15,4	130,0	311,0
62518	25 G 0,75	18	18,5	180,0	498,0
62519	34 G 0,75	18	20,5	245,0	550,0
62520	36 G 0,75	18	20,6	259,0	570,0
62521	42 G 0,75	18	22,3	302,0	600,0
62522	3 G 1,5	16	8,6	43,0	100,0
62523	4 G 1,5	16	9,5	58,0	122,0
62524	5 G 1,5	16	10,3	72,0	148,0
62525	7 G 1,5	16	12,0	101,0	197,0
62526	9 G 1,5	16	14,2	130,0	244,0
62527	12 G 1,5	16	14,7	173,0	328,0
62528	18 G 1,5	16	17,2	259,0	459,0

Part no.	No. cores x cross-sec. mm ²	AWG-No.	Outer Ø app. mm	Cop. weight kg / km	Weight app. kg / km
62529	25 G 1,5	16	20,8	360,0	665,0
62530	34 G 1,5	16	23,0	490,0	1084,0
62531	41 G 1,5	16	25,1	590,0	1260,0
62532	50 G 1,5	16	27,7	720,0	1521,0
62533	60 G 1,5	16	29,5	864,0	1885,0
62534	3 G 2,5	14	9,8	72,0	160,0
63136	4 G 2,5	14	10,6	96,0	173,0
62535	5 G 2,5	14	11,9	120,0	268,0
62536	7 G 2,5	14	13,6	168,0	307,0
62537	9 G 2,5	14	16,1	216,0	437,0
62538	12 G 2,5	14	16,9	288,0	572,0
62539	18 G 2,5	14	20,1	432,0	800,0
62540	25 G 2,5	14	25,1	600,0	1100,0
62541	3 G 4	12	11,3	115,0	221,0
62542	4 G 4	12	12,4	154,0	247,0
62543	5 G 4	12	13,8	192,0	318,0
62544	7 G 4	12	16,9	269,0	438,0
62545	4 G 6	10	15,3	230,0	383,0
62546	5 G 6	10	16,6	288,0	481,0
62547	7 G 6	10	18,2	403,0	800,0
62548	4 G 10	8	19,7	384,0	671,0
62549	5 G 10	8	22,0	480,0	990,0
62550	4 G 16	6	23,7	614,0	951,0
62551	5 G 16	6	26,1	768,0	1500,0
62552	4 G 25	4	34,0	960,0	1700,0
62554	4 G 35	2	37,0	1344,0	2300,0

Dimensions and specifications may be changed without prior notice. (RN01)

MULTIFLEX 600-C

highly flexible, oil resistant, screened, EMC-preferred type,
open installation TC-ER, PLTC-ER, NFPA 79



Technical data

- Highly flexible PVC control cable acc. to UL Std. 1277
- **Temperature range**
flexing -5°C to +90°C
fixed installation -40°C to +90°C
- **Nominal voltage**
TC 600 V
WTTTC 1000 V
- **Test voltage**
3000 V
- **Coupling resistance**
max. 250 Ohm/km
- **Minimum bending radius**
flexing 10x cable Ø
- **Insulation resistance**
min. 20 MOhm x km
- **Radiation resistance**
up to 80x10⁶ cJ/kg (up to 80 Mrad)

Cable structure

- Bare copper conductor, extra fine wire stranded, with AWG dimensions
- Core insulation of special PVC with transparent nylon skin
- Core identification to DIN VDE 0293 black cores with continuous white numbering
- GN-YE conductor, 3 cores and above in the outer layer
- Cores stranded in layers with optimal lay length
- Separating foil
- Braided screening of tinned copper wires, coverage approx. 85%
- Separator
- Outer sheath of special PVC
- Sheath colour: black (RAL 9005)
- With length marking in feet

Properties

- The materials used during manufacturing are cadmium-free, contain no silicone and are free from substances harmful to the wetting properties of lacquers
- UV resistant
- **Tests**
- Self-extinguishing and flame retardant acc. to CSA FT4
- **UL:**
TC-ER, PLTC-ER (AWG 18 - AWG 12), ITC-ER (AWG 18 - AWG 12), MTW, NFPA 79, WTTTC 1000 V, DP-1, OIL RES I&II, 90°C dry / 75°C wet, Class 1 Div. 2 per NEC Art 336, 392, 501, crush impact test acc. to UL 1277
- **CSA:**
c(UL) CIC-TC FT4, CSA AWM I/II A/B FT4

Note

Advantages

- Highly flexible, simple installation

Available on request

- With blue cores (DC)
- With red cores (AC)
- Grey or TPE outer sheath

Application

HELUKABEL® MULTIFLEX 600-C is a highly flexible, oil resistant control cable. The special combination of TC-ER, PLTC-ER and ITC-ER allows this cable to be used as a connecting cable for industrial plant and machinery in accordance with NFPA 79. Approved for open, unprotected installation in cable trays to the machine. Its outstanding oil resistance (OIL RES I & II) guarantees a long service life; for industrial applications in dry, damp and wet environments. Recommended applications: Production lines, bottling plants, machine construction, switch cabinets, conveyor systems, packaging machines, automotive industry. For the use in energy drag chains please note the installation guidelines.

EMC = Electromagnetic compatibility

To optimize the EMC features we recommend a large round contact of the copper braiding on both ends.

= Product conforms with Low-Voltage Directive 2014/35/EU.

Part no.	No. cores x cross-sec. mm ²	AWG-No.	Outer Ø app. mm	Cop. weight kg / km	Weight app. kg / km
62556	2 x 0,5	20	7,7	30,0	80,0
62557	3 G 0,5	20	8,0	37,0	85,0
62558	4 G 0,5	20	8,7	46,0	100,0
62559	5 G 0,5	20	9,3	54,0	113,0
62560	7 G 0,5	20	10,7	70,0	152,0
62561	12 G 0,5	20	12,3	112,0	210,0
62562	18 G 0,5	20	15,1	153,0	304,0
62563	25 G 0,5	20	18,1	225,0	408,0
62564	34 G 0,5	20	19,8	267,0	530,0
62565	3 G 0,75	18	8,5	55,0	101,0
62566	4 G 0,75	18	9,3	69,0	127,0
62567	5 G 0,75	18	10,0	82,0	148,0
62568	7 G 0,75	18	11,6	119,0	186,0
62569	12 G 0,75	18	14,1	178,0	286,0
62570	15 G 0,75	18	15,2	175,0	455,0
62571	18 G 0,75	18	16,3	252,0	383,0
62572	25 G 0,75	18	19,6	362,0	514,0
62573	34 G 0,75	18	21,9	473,0	685,0
62574	3 G 1,5	16	9,3	75,0	131,0
62575	4 G 1,5	16	10,2	93,0	165,0
62576	5 G 1,5	16	11,0	113,0	195,0
62577	7 G 1,5	16	12,9	162,0	250,0
62578	9 G 1,5	16	15,2	193,0	340,0
62579	12 G 1,5	16	15,6	249,0	393,0

Part no.	No. cores x cross-sec. mm ²	AWG-No.	Outer Ø app. mm	Cop. weight kg / km	Weight app. kg / km
62580	18 G 1,5	16	18,4	376,0	559,0
62581	25 G 1,5	16	23,1	510,0	788,0
62582	34 G 1,5	16	25,8	674,0	1203,0
62583	3 G 2,5	14	10,3	141,0	218,0
62584	4 G 2,5	14	11,5	149,0	222,0
62585	5 G 2,5	14	12,4	195,0	350,0
62586	7 G 2,5	14	15,4	243,0	373,0
62587	9 G 2,5	14	16,8	312,0	479,0
62588	12 G 2,5	14	18,5	368,0	730,0
62589	18 G 2,5	14	22,4	639,0	1140,0
62590	25 G 2,5	14	25,5	796,0	1530,0
62591	3 G 4	12	11,7	180,0	296,0
62592	4 G 4	12	13,3	221,0	305,0
62593	5 G 4	12	14,7	330,0	450,0
62594	7 G 4	12	17,8	363,0	536,0
62595	4 G 6	10	16,1	314,0	469,0
62596	5 G 6	10	17,5	441,0	772,0
62597	7 G 6	10	20,6	505,0	1028,0
62598	4 G 10	8	21,9	526,0	790,0
62599	5 G 10	8	24,1	610,0	1096,0
62600	4 G 16	6	24,8	730,0	1621,0
62602	5 G 16	6	27,2	1050,0	1759,0
62603	4 G 25	4	33,1	1450,0	2100,0
62605	4 G 35	2	37,8	1840,0	2550,0

Dimensions and specifications may be changed without prior notice. (RN01)

TOPFLEX® 600 VFD

EMC-preferred type, flexible motor power supply cable,
oil resistant, NFPA 79



Technical data

- PVC motor supply cable acc. to UL Std. 1277 and UL Std. 2277
- **Temperature range**
-25°C to +90°C
- **Nominal voltage**
TC 600 V
WTTC 1000 V
- **Test voltage**
4000 V
- **Minimum bending radius**
flexing 6x cable Ø
- **Coupling resistance**
max. 250 Ohm/km

Cable structure

- Tinned copper conductor, fine wire with AWG dimensions
- Special PVC core insulation with transparent nylon skin
- Black cores with continuous white numbering
- GN-YE conductor in the outer layer
- Cores stranded in layers with optimal lay length
- Fleece
- 1. Screening with special aluminium foil
- 2. Screening with braid of tinned copper wires, optimal coverage approx. 85%
- Separator
- Special PVC outer sheath
- Sheath colour: black (RAL 9005) or orange (RAL 2003)
- With length marking in feet

Properties

- The materials used during manufacturing are cadmium-free, contain no silicone and are free from substances harmful to the wetting properties of lacquers
- UV resistant

Tests

- Self-extinguishing and flame retardant acc. to CSA FT4
- **UL:**
TC-ER, WTTC 1000 V, MTW, NFPA 79, PLTC-ER (AWG 18 - AWG 12), ITC-ER (AWG 18 - AWG 12) OIL RES I & II, 90°C dry / 75°C wet, -40°C Cold Bend Test, Class 1 Div. 2 per NEC Art. 336, 392, 501
- **CSA:**
c (UL) CIC-TC FT4, AWM I/II A/B FT4

Note

- VFD = Variable Frequency Drive

Application

Flexible, extremely oil resistant motor supply cable for modern servomotors; the double screening with special aluminium foil (100% coverage) and tinned copper braid (approx. 85% coverage) provides effective protection against electrical disturbance and the resultant failures. NFPA 79 approved for open, unprotected installation on cable trays and from cable trays to the machine. The special PVC sheath is extremely resistant to oil, coolants and solvents and hence the perfect solution for industrial applications with open installation, installation in pipes and in the ground.

EMC = Electromagnetic compatibility

To optimize the EMC features we recommend a large round contact of the copper braiding on both ends.

☞☞ = Product conforms with Low-Voltage Directive 2014/35/EU.

Sheath colour black

Part no.	No. cores x cross-sec. mm ²	AWG-No.	Outer Ø app. mm	Cop. weight kg / km	Weight app. kg / km
63139	4 x 0,963	18	9,9	52,0	164,0
63140	4 x 1,31	16	11,4	72,0	183,0
63137	4 x 2,08	14	12,5	118,0	197,0
63141	4 x 3,31	12	14,0	182,0	267,0
63142	4 x 5,26	10	17,1	256,0	402,0
63143	4 x 8,37	8	22,3	417,0	668,0
63144	4 x 13,31	6	25,4	651,0	918,0
63145	4 x 21,21	4	30,1	910,0	1363,0
63146	4 x 33,6	2	35,3	1411,0	1994,0

Sheath colour orange

Part no.	No. cores x cross-sec. mm ²	AWG-No.	Outer Ø app. mm	Cop. weight kg / km	Weight app. kg / km
63147	4 x 0,963	18	9,9	52,0	164,0
63148	4 x 1,31	16	11,4	72,0	183,0
63149	4 x 2,08	14	12,5	118,0	197,0
63150	4 x 3,31	12	14,0	182,0	267,0
63151	4 x 5,26	10	17,1	182,0	267,0
63152	4 x 8,37	8	22,3	417,0	668,0
63153	4 x 13,31	6	25,4	651,0	918,0
63154	4 x 21,21	4	30,1	910,0	1363,0
63155	4 x 33,6	2	35,3	1411,0	1994,0

Dimensions and specifications may be changed without prior notice. (RN07)

TOPFLEX® 650 VFD

EMC-preferred type, flexible motor power supply cable with control cores, oil resistant, NFPA 79



Technical data

- TPE motor supply cable acc. to UL Std.1277 and UL Std.2277
- **Temperature range**
flexing -25°C to +105°C
- **Nominal voltage**
TC 600 V
WTTC 1000 V
- **Test voltage**
power supply cores 4000 V
control cores 2000 V
- **Minimum bending radius**
flexing 6x cable Ø
- **Coupling resistance**
max. 250 Ohm/km

Cable structure

- Tinned copper conductor, fine wire with AWG dimensions
- Special PVC core insulation with transparent nylon skin
- Black supply cores with continuous white numbering
- 2 black control cores numbered 5+6
- GN-YE conductor in the outer layer
- Control cores screened in pairs with plastic-coated aluminium foil, tinned drain wire
- Control cores stranded in pairs and laid up in layers with optimal lay length with the power supply cores
- 1. Screening with plastic-coated aluminium foil
- 2. Screening from tinned copper braid, optimal coverage approx. 85%
- Separator
- Special TPE outer sheath
- Sheath colour: black (RAL 9005) or orange (RAL 2003)
- With length marking in feet

Properties

- The materials used during manufacturing are cadmium-free, contain no silicone and are free from substances harmful to the wetting properties of lacquers
- UV resistant

Tests

- Self-extinguishing and flame retardant acc. to CSA FT4
- **UL:**
TC-ER, WTTC 1000 V, MTW, NFPA 79, PLTC-ER (AWG 18 - AWG 12), ITC-ER (AWG 18 - AWG 12) OIL RES I & II, 90°C dry / 75°C wet, -40°C Cold Bend Test, Class 1 Div. 2 per NEC Art. 336, 392, 501
- **CSA:**
c (UL) CIC-TC FT4, AWM I/II A/B FT4

Note

- VFD = Variable Frequency Drive

Application

Flexible, extremely oil resistant motor supply cable for modern servomotors; the double screening with special aluminium foil (100% coverage) and tinned copper braid (approx. 85% coverage) provides effective protection against electrical disturbance and the resultant failures. NFPA 79 approved for open, unprotected installation on cable trays and from cable trays to the machine. The special TPE sheath is extremely resistant to oil, coolants and solvents and hence the perfect solution for industrial applications with open installation, installation in pipes and in the ground.

EMC = Electromagnetic compatibility

To optimize the EMC features we recommend a large round contact of the copper braiding on both ends.

= Product conforms with Low-Voltage Directive 2014/35/EU.

Sheath colour: black

Part no.	No. cores x AWG-No.	Cross-section mm ²	Outer Ø app. mm	Cop. weight kg / km	Weight app. kg / km
63156	4x AWG 16 +2x AWG 18	1,31/ 0,963	13,0	88,0	259,0
63157	4x AWG 14 +2x AWG 18	2,08/ 0,963	14,0	133,0	370,0
63138	4x AWG 14 +2x AWG 14	2,08/ 2,08	14,0	159,0	399,0
63158	4x AWG 12 +2x AWG 18	3,31/ 0,963	15,3	197,0	435,0
63159	4x AWG 12 +2x AWG 14	3,31/ 2,08	15,7	224,0	466,0
63160	4x AWG 10 +2x AWG 14	5,26/ 2,08	18,2	301,0	703,0
63161	4x AWG 8 +2x AWG 14	8,37/ 2,08	24,1	457,0	901,0
63162	4x AWG 6 +2x AWG 14	13,31/ 2,08	27,4	615,0	1275,0
63163	4x AWG 4 +2x AWG 14	21,21/ 2,08	33,4	1450,0	1861,0

Sheath colour: orange

Part no.	No. cores x AWG-No.	Cross-section mm ²	Outer Ø app. mm	Cop. weight kg / km	Weight app. kg / km
62876	4x AWG 16 +2x AWG 18	1,31/ 0,963	13,0	88,0	259,0
62877	4x AWG 14 +2x AWG 18	2,08/ 0,963	14,0	133,0	370,0
62878	4x AWG 14 +2x AWG 14	2,08/ 2,08	14,0	159,0	399,0
62879	4x AWG 12 +2x AWG 18	3,31/ 0,963	15,3	197,0	435,0
62880	4x AWG 12 +2x AWG 14	3,31/ 2,08	15,7	224,0	466,0
62881	4x AWG 10 +2x AWG 14	5,26/ 2,08	18,2	301,0	703,0
62882	4x AWG 8 +2x AWG 14	8,37/ 2,08	24,1	457,0	901,0
62883	4x AWG 6 +2x AWG 14	13,31/ 2,08	27,4	615,0	1275,0
62884	4x AWG 4 +2x AWG 14	21,21/ 2,08	33,4	1450,0	1861,0

Dimensions and specifications may be changed without prior notice. (RN07)



Machine outlet IP67

LWL- outdoor cable

BUS cables

Industrial Ethernet

LWL-Breakout cable robust, flexible

Accessories

Connection equipment



■ COMMUNICATION CABLES FOR WIND TURBINES

Designation	Page
Fibre Optic Communication in Wind Turbines	220
Fibre Optic and Copper Communication	221
Pre-Assembled Fibre Optic Cables	222
Fibre Optic Plug- & Adapter Overview	226
Communication Connection equipment	228
Machine outlet IP67	228
Machine outlet IP65	229
Copper cabling	230
PROFInet Typ B SF/UTP PVC flexibl	230
PROFInet Typ C Torsion S/UTP PUR	231
WK Industrial SF/UTP X-FRNC 105°C	232
TORDIERFLEX Industrial Ethernet SF/UTP PUR	233
WK CAN BUS 105°C	234
PROFIBUS SK indoor	235
PROFIBUS SK outdoor ¹	235
PROFIBUS L2 Torsion	236
PROFIBUS SK Industrial	237
Fibre Optic cabling turbine	238
HELUCOM® AT-V(ZN)Y(ZN)Y	238
HELUCOM® AT-V(ZN)H(ZN)11Y	238
HELUCOM® WK mobile A-V(ZN)11Y	239
HELUCOM® WK mobile A-V(ZN)YY	240
HELUCOM® Fiber optic Breakout cable industrial HCS I-V(ZN)YY	241
HELUCOM® Fiber optic Breakout cable industrial HCS I-V(ZN)Y11Y	242
HELUCOM® Plastic-fibre Optic cable industrial PROFInet B POF/PA I-V4Y(ZN)Y	243
HELUCOM® Plastic-fibre Optic cable industrial PROFIBUS POF/PA I-V4Y(ZN)Y	244
HELUCOM® Plastic-fibre Optic cable industrial POF/PE I-V2Y, I-V2Y(ZN)11Y	245
HELUCOM® Fiber optic universal cable A/I-DQ(ZN)BH	246
Fibre Optic cabling infrastructure	247
HELUCOM® Fiber optic outdoor cable A-DQ(ZN)B2Y (central)	247
HELUCOM® Fiber optic outdoor cable A-DQ(ZN)B2Y (stranded)	248
HELUCOM® Fiber optic outdoor cable A-DQ(ZN)B2Y (stranded, Multifibre)	249
LIYY-TP-UL	250

■ FIBRE OPTIC COMMUNICATION IN WIND TURBINES



Fast Bus

- HCS 200/230 μm
- G50/125 μm
- G62,5/125 μm

Control and adjustment of a wind turbine's performance by positioning the rotor blades; real-time rotor blade adjustment according to the environmental conditions and the requirements of the local energy supplier.



Condition Monitoring System (CMS)

- G50/125 μm
- G62,5/125 μm

The Condition Monitoring System allows to measure and analyze a wind turbine's operating data. By means of on- and offline monitoring, the CMS evaluates data gained from swing-and-push-impulse-sensors, the lubrication system and thermal indicators. The CM System allows to detect deviations from a turbine's regular parameters early and helps to prevent any damages or down-time. Hence, service and maintenance work can be scheduled to be more efficient and save time and money.

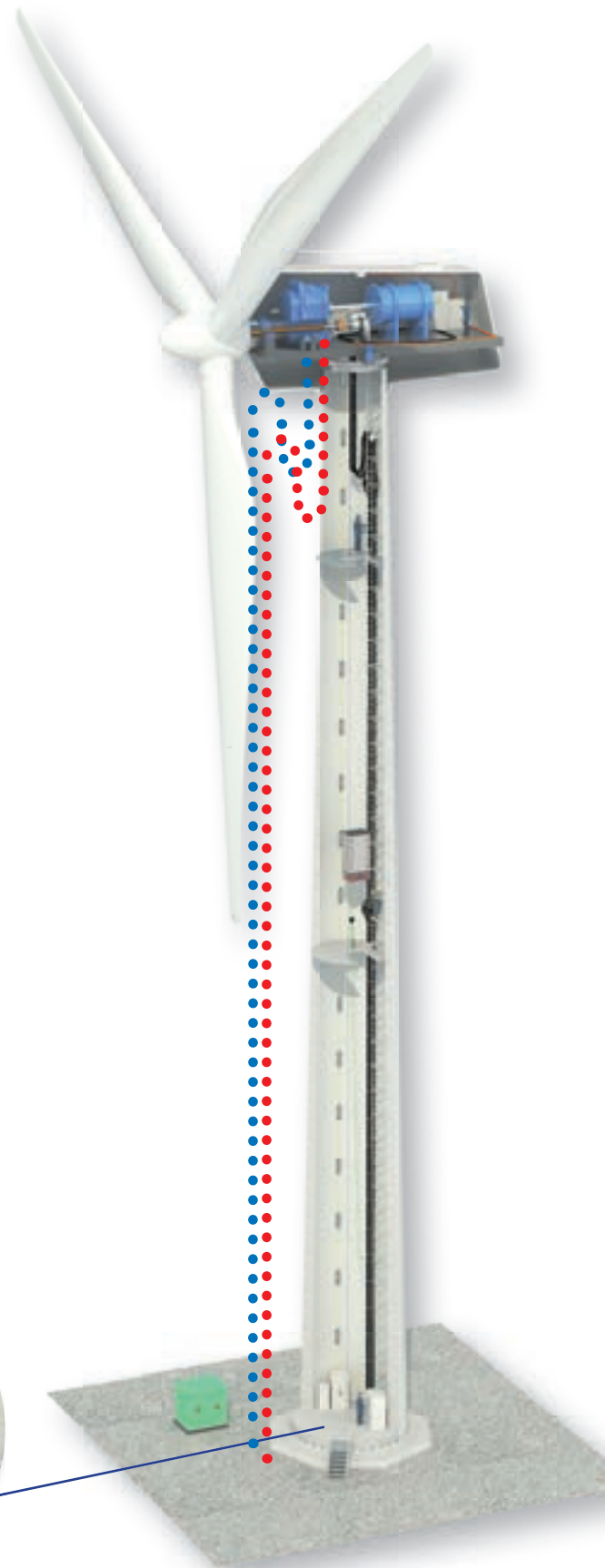

■ FIBRE OPTIC AND COPPER COMMUNICATION

Fibre optic cabling made easy – pre-assembled fibre optic cable systems

No special knowledge or tools are needed to install HELUCOM® pre-assembled fibre optic cables. The cable comes pre-assembled and can be connected immediately after it has been laid. As a result, the installation process of complete sections of fibre optic connections actually involves nothing more than laying the cable itself. The pulling aid is connected to the pull cable. As a result, it is possible to lay the cable together with the pre-assembled distributor just as you would lay a standard cable.

The advantage of a pre-assembled cable is in the considerable time savings in installing the fibre optic cable.

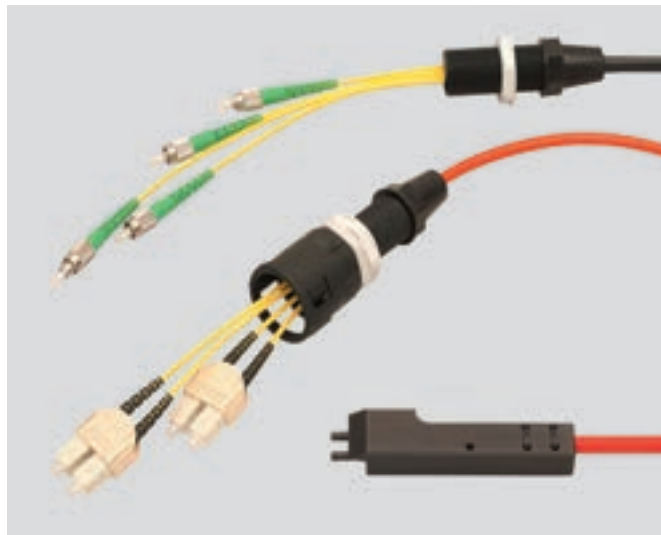
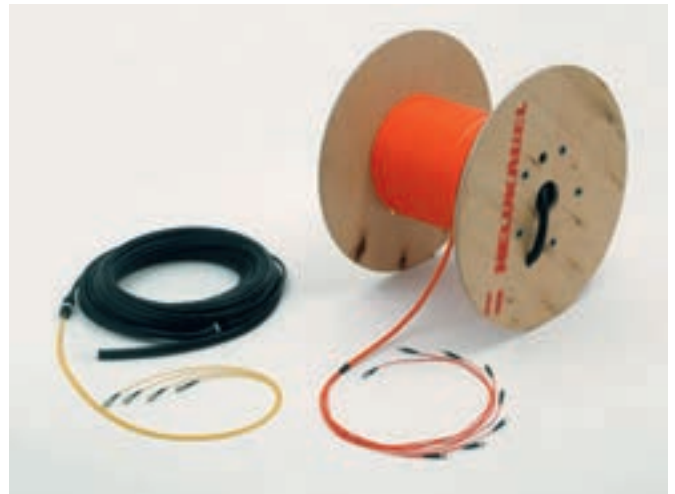

Fibre Optic and Copper Technology Connection

In addition to the corresponding cables, passive connection components for copper and fibre-optic technology are needed for the network infrastructure. The components can be divided into two groups, independently of the transmission medium. On the one hand, there are jumpering and distribution devices and on the other hand there are patch cables or terminal cables. This includes system-conformant bus connecting cables, patch panels, outlet boxes, connector systems and patch cables.

- Fibre optic jumper cable ST /ST, 50/125, clx
- Modular Patch Panel (DIN rail)
- 19" Fibre optic splice box
- POF jumper cable (duplex)
- RJ 45 jumper cable PUR / IP20
- PROFIBUS jumper cable M12 / PUR

Our brands for Data, Network & Bus Technology:

HELUKAT
DATEN- UND NETZWERKTECHNIK

HELUCOM
DATEN- UND NETZWERKTECHNIK

HELUKAT
CONNECTING SYSTEMS INDUSTRY

HELUCOM
CONNECTING SYSTEMS INDUSTRY

The entire range can be found in our Data, Network & Bus Technology catalogue.



■ PRE-ASSEMBLED FIBRE OPTIC CABLES

No special knowledge or tools are needed to install HELUCOM® pre-assembled fibre optic cables. The cable is pre-assembled and can be connected immediately after it has been laid. As a result, the installation process actually comprises nothing more than laying the cable itself. In the distributor bodies, the fibres from the loose-tube cable are conducted through the individual simplex cables without splicing. The simplex cables are terminated using pre-assembled plugs. Included in delivery is a plug

shield that protects the plugs, simplex cables and distributor body while the cable is being laid. The pulling aid is connected to the pull cable. As a result, it is possible to lay the cable together with the pre-assembled distributor just as you would lay a standard cable. The benefits of pre-assembled are easy to see: The fibre optic cables are cut to the desired length, and the fibres are glued to different plug models in a clean and dust-free environment.

Features:

Applications:

1. Outdoor wiring
2. Indoor wiring

Cable types:

- Zipcords with halogen-free outer jacket
- Breakout cables with halogen-free outer jacket
- Mini breakout cables with halogen-free outer jacket
- Fibre optic cables with central / s stranded loose-tube cable
- Plastic fibre cables (POF)

Fibre types:

- E9/125 µm
- G50/125 µm
- G62,5/125 µm
- 200/230 µm
- 980/1000 µm

Plug systems:

- ST, SC, SCdx, LC, MTRJ, E-2000, DIN, FDDI, FC-PC and F-SMA

Additional pre-assembled kits:

- Pulling aid
- Pulling tube
- Core coding

Pre-assembled fibre optic cables



01 The pre-assembled loose-tube cable together with distributor body and pulling protection as it appears just before shipment. Depending on the length of the cable, the cable can be shipped as a ring or on a disposable shipping reel.



02 Detailed view of the cable and with pulling aid.



03 Detailed view of the robust cast distributor body. The distributor body is equipped with a compatible plastic gland for installation in splice boxes. In addition, the system can be reused in a new installation.



04 Mini loose-tube cables designed to allow easy insertion into prepared splice boxes. In addition, the mini loose-tube cables are number-coded.



05 Glass fiber splice box used as cable end enclosure for multi-core fiber optic cables in 19" cabinets. The splice box is particularly suitable as a connecting unit for our pre-fabricated fiber-optic grooved cables.

PRE-ASSEMBLED FIBRE OPTIC CABLES

Matrix Distributor bodies

Designation	Figure	Top view	
		compact fib e	empty fib e
WKOM-01			
WKOM-02			
WKOM-03			
WKOM-04			
WKOM-05			
Designation	Figure	Top view	
WKOM-100			
WKOM-101			
WKOM-102-4			
WKOM-102-5			

Cable allocation

Designation	Figure	Top view
WKOM-105		
WKOM-106		
WKOM-107		

Compact fibre max. number	Empty fibre max. number	Thread type	Fibre optic cable max \varnothing [mm]	Allocation table				
				length [mm]	D [mm]	d _A [mm]	d _I [mm]	
24	-	PG21	12	80	39	34	28	
12	-	PG16	12	80	34	28	23	
4	12	PG11	10	66	29	26	18,5	
4	12	-	10	35	17	-	-	
4	4	-	5	29	12	-	-	
Thread type	Cable A max \varnothing [mm]	Cable B number	Cable B \varnothing [mm]	Allocation table				
				Length [mm]	D [mm]	d _A [mm]	d _I [mm]	
PG16	12	2	6	80	34	28	23	
PG16	12	3	6	80	34	28	23	
PG21	12	4	8	80	39	34	28	
PG21	12	5	6	80	39	34	28	

Thread type	Cable A max \varnothing [mm]	Cable B number	Cable B \varnothing [mm]	Allocation table				
				Length [mm]	D [mm]	d _A [mm]	d _I [mm]	
-	14	2	12	110	-	18	14	
-	10	2	8	100	-	14	10	
-	8	2	6	100	-	12	8	

■ FIBRE OPTIC PLUG & ADAPTER OVERVIEW

ST plug



- Ceramic ferrule
- Available for single mode or multi-mode

ST adapter



- Ceramic ferrule
- Available for single mode or multi-mode

SC/SCdx plug



- Ceramic ferrule
- Normal cross section or 8° diagonal cross section (single mode only)
- Available for single mode or multi-mode

SC/SCdx adapter



- Ceramic ferrule
- Normal cross section or 8° diagonal cross section (single mode only)
- Available for single mode or multi-mode

LC plug



- Ceramic ferrule
- Available for single mode or multi-mode

LC adapter



- Ceramic ferrule
- Available for single mode or multi-mode

E-2000 plug



- Ceramic ferrule
- Normal cross section or 8° diagonal cross section (single mode only)
- Available for single mode or multi-mode

E-2000 adapter



- Ceramic ferrule
- Normal cross section or 8° diagonal cross section (single mode only)
- Available for single mode or multi-mode

DIN plug



- Ceramic ferrule
- Available for single mode or multi-mode

DIN adapter



- Ceramic ferrule
- Available for single mode or multi-mode

MTRJ Plug



- Ceramic ferrule
- Available for single mode or multi-mode

MTRJ adapter



- Ceramic ferrule
- Available for single mode or multi-mode

FC PC plug



- Ceramic ferrule
- Normal cross section or 8° diagonal cross section (single mode only)
- Available for single mode or multi-mode

FC PC adapter



- Ceramic ferrule
- Normal cross section or 8° diagonal cross section (single mode only)
- Available for single mode or multi-mode

F-SMA plug



- Ceramic ferrule
- Available for single mode or multi-mode

F-SMA adapter



- Ceramic ferrule
- Available for single mode or multi-mode

Machine outlet IP67

INDUSTRIAL ETHERNET



SC MM, IP67



Type

Industrial Ethernet, SCdx multimode outlets IP67

Configuration

Housing material:
Colour:
Outlet direction:
Type of fastening:
Dust protection:
Protection classification (IP):

Aluminium die-cast
Grey
Straight
Screw
Hinged cover
67

Equipment

Type:
Number of couplings:
Suitable for fibre type:

Coupler
SC
2
Multi-mode

Dimension

175 x 110 x 45mm

Area of application

Industrial environment

Part no.

801354

Dimensions and specifications may be changed without prior notice.

Packing unit

5

Norms and standards

HELUCOM CONNECTING SYSTEMS® INDUSTRY component suitable for multimode fibre applications (G50/125µm and G62.5/125µm). Moreover it satisfies the MICE specifications (class 3), EMC requirements in accordance with DIN EN 6100, and the requirements of the IP 67 housing protection class.

Application

Robust data connection socket (shielded) for the extreme implementation. Robust aluminum die-cast housing; meets all mechanical requirements like vibration, shock, and transverse forces. The socket is used either on the machine distributor (MD) or wall mounted directly on the machine (MC) as connection unit.

Machine outlet IP65

INDUSTRIAL ETHERNET



SC MM, IP65



Type

Industrial Ethernet outlet plastic IP 65, SCdx POF/HCS/MM

Configuration

Housing material: Aluminium die-cast
Colour: Grey similar to RAL 7032
Outlet direction: Straight
Type of fastening: Screw
Dust protection: Hinged cover
Protection classification (IP): 65

Equipment

Type: Coupler
Number of couplings: SC
Suitable for fibre type: 2 POF/HCS/MM

Dimension

125 x 80 x 57mm

Area of application

Industrial environment

Part no.

801421

Dimensions and specifications may be changed without prior notice.

Packing unit

5

Norms and standards

HELUCOM CONNECTING SYSTEMS® INDUSTRY component suitable for POF, HCS and multimode fibre applications (980/1000µm, 200/230µm, 50/125µm and 62.5/125µm). More they satisfy the MICE specifications, EMC requirements in accordance with DIN EN 61000, and the IP65 housing protection class requirements. The socket can be used in a temperature range of 0°C to +70°C.

Application

Robust data connection socket (shielded) for extreme implementation. Robust plastic housing, and satisfies all mechanical requirements like vibration, shock, and transverse forces. The socket is used either on the machine distributor (MD) or wall mounted directly on the machine (MC) as connection unit.

Industrial Ethernet

PROFINet Type B flexible

HELUKAT

PVC

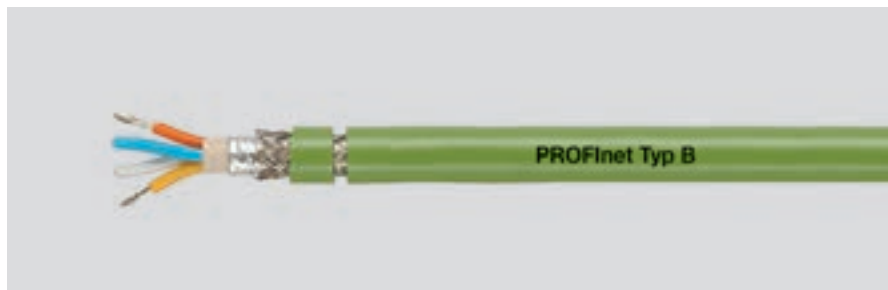

Type

Cable structure

Inner conductor diameter:
Core insulation:
Core colours:
Stranding element:
Separator:
Inner sheath material:
Total shielding:
Outer sheath material:
Cable external diameter:
Outer sheath colour:

Mobile use

2x2x0,75 mm (stranded)

Copper, tinned (AWG 22/ 7)
PE
wh, ye, bu, og
Star quad
Polyester foil over stranded bundle
PVC
Cu braid, tinned
PVC
app. 6,5 mm ± 0,2 mm
Green similar to RAL 6018

Electrical data

Characteristic impedance: 100 Ohm ± 15 Ohm at 1 to 100 MHz
Conductor resistance, max.: 60 Ohm/km
Insulation resistance, min.: 0,5 GOhm x km
Loop resistance: 120 Ohm/km max.
Mutual capacitance: 52 nF/km nom.
Test voltage: 2 kV

Typical values

Frequency (MHz)	10	16	62,5	100
Attenuation (dB/100m)	6,3	8,0	16,5	21,3
Next (db)	70,0	65,0	55,0	50,0
ACR (db)	64,0	57,4	39,0	29,0

Technical data

Weight: app. 67 kg/km
bending radius, repeated: 100 mm
Operating temperature range min.: -40°C
Operating temperature range max.: +75°C
Caloric load, approx. value: 0,32 MJ/m
Copper weight: 32,00 kg/km

Norms

Applicable standards: PROFINet Guideline + IEC 61158-2
Acc. to ISO/IEC 11801
Acc. to EN 50173
Category 5e
Flame-retardant acc. to IEC 60332-3
UL Style: CMG 75°C PLTC FT4
CSA standard: CSA FT 4

Application

HELUKAT® PROFINet Type B (flexible) Cat.5e for use on moving parts. The cables listed here correspond to the PROFINet classifications Type B for moving cables and are designed to withstand mechanical loads. The version PVC is the standard cable; the FRNC version is used for halogen free requirements.

Part no.

800654, PROFINet type B (SK)

Dimensions and specifications may be changed without prior notice.

Industrial Ethernet

PROFINet Type C Torsion

HELUKAT

PUR



Type

Cable structure

Inner conductor diameter:
Core insulation:
Core colours:
Stranding element:
Separator:
Total shielding:
Outer sheath material:
Cable external diameter:
Outer sheath colour:

Torsional applications

2x2x0,75 mm (stranded)

Copper, tinned (AWG 22/19)
Foam-skin-PE
wh, ye, bu, og
Star quad
Polyester foil over stranded bundle
Cu braid, tinned
PUR
app. 6,5 mm ± 0,2 mm
Green similar to RAL 6018

Electrical data

Characteristic impedance:
Conductor resistance, max.:
Insulation resistance, min.:
Loop resistance:
Mutual capacitance:
Test voltage:

100 Ohm ± 15 Ohm at 1 to 100 MHz
60 Ohm/km
0,5 GOhm x km
120 Ohm/km max.
52 nF/km nom.
0,7 kV

Typical values

Frequency (MHz)	10	16	62,5	100
Attenuation (db/100m)	7,6	10,0	26,5	41,0
ELFEXT (db)	43,8	39,7	24,0	20,0

Technical data

Weight: app. 54 kg/km
bending radius, repeated: 70 mm
Operating temperature range min.: -40°C
Operating temperature range max.: +80°C
Caloric load, approx. value: 0,45 MJ/m
Copper weight: 32,00 kg/km

Norms

Applicable standards: PROFINet Guideline + IEC 61158-2
Category 5e
Halogen-free acc. to 60754-1
Flame-retardant acc. to IEC 60332-1-2
UL Style: AWM Style 21161 80°C

Application

HELUKAT® PROFINet Type C Category 5e TORSION offers excellent transmission characteristics and is designed for applications with torsion loads, e.g. in robots. The cable listed here corresponds to the PROFINet Type C classification for continuous movement.

Part no.

802186, PROFINet type C (SK)

Dimensions and specifications may be changed without prior notice.

Industrial Ethernet

WK Industrial 105°C

HELUKAT® 100IND

SF/UTP, Category 5e



Type

Cable structure

Inner conductor diameter:
Core insulation:
Core colours:
Stranding element:
Separator:
Total shielding:
Outer sheath material:
Cable external diameter:
Outer sheath colour:

Windenergy

SF/UTP 2x2x0,75 mm (stranded)

Copper, tinned (AWG 22/ 7)
XLPE ray cross-linking
wh, ye, bu, og
Star quad
Polyester foil over stranded bundle
Cu braid, tinned
X-FRNC
app. 6,5 mm ± 0,2 mm
Black similar to RAL 9005

Electrical data

Characteristic impedance: 100 Ohm ± 15 Ohm at 1 to 100 MHz
Conductor resistance, max.: 60 Ohm/km
Insulation resistance, min.: 0,5 GOhm x km
Loop resistance: 120 Ohm/km max.
Mutual capacitance: 57 nF/km nom.
Test voltage: 2 kV
Relative propagation velocity: 69 %

Typical values

Frequency (MHz)	10	16	62,5	100
Attenuation (dB/100m)	6,3	8,0	16,5	21,3
Next (db)	70,0	65,0	55,0	50,0
ACR (db)	63,7	57,0	38,5	28,7

Technical data

Weight: app. 64 kg/km
bending radius, repeated: 52 mm
Operating temperature range min.: -40°C
Operating temperature range max.: +105°C *
Caloric load, approx. value: 0,89 MJ/m
Copper weight: 34,00 kg/km

Norms

Acc. to ISO/IEC 11801 , Acc. to EN 50173, Category 5, Flame-retardant acc. to IEC 60332-3, Halogen-free acc. to 60754-1
, Corrosiveness acc. to EN50267-2-3
, UL-Style 21281 80°C/300V

Application

HELUKAT® 100IND Category 5e WK Industrial 105°C is designed specially for demanding temperature requirements such as those encountered in wind turbines. Radiation cross-linking provides improved thermal stability as well as good oil resistance.

Part no.

802293, INDUSTRIAL ETHERNET CAT.5

Dimensions and specifications may be changed without prior notice.

Industrial Ethernet

TORDIERFLEX

HELUKAT® 100T

SF/UTP, Category 5



Type

Cable structure

Inner conductor diameter:
Core insulation:
Core colours:
Stranding element:
Separator:
Screen 1 over stranding:
Screen 2 over stranding:
Outer sheath material:
Cable external diameter:
Outer sheath colour:

Torsion Patch Cables

SF/UTP 4x2xAWG 26/ 19 (stranded) PUR

Copper, bare (AWG 26/ 19)
PP
wh/bu, wh/og, wh/gn, wh/bn
Double core
Polyester foil over stranded bundle
Polyester foil copper, bare
Cu braid
PUR
app. 7,5 mm
Green similar to RAL 6018

Electrical data

Characteristic impedance: 100 Ohm \pm 15 Ohm at 1 to 100 MHz
Loop resistance: 260 Ohm/km max.
Mutual capacitance: 50 nF/km nom.
Relative propagation velocity: 68 %

Typical values

Frequency	(MHz)	10	16	62,5	100
Attenuation	(dB/10m)	0,9	1,2	2,4	3,1
Next	(db)	56,0	53,0	43,0	40,0
ACR	(db)	55,1	51,8	40,6	36,9

Technical data

Weight: app. 74 kg/km
bending radius, repeated: 56 mm
Operating temperature range min.: -20°C
Operating temperature range max.: +60°C
Caloric load, approx. value: 1,234 MJ/m
Copper weight: 29,50 kg/km

Norms

Acc. to ISO/IEC 11801, Acc. to EN 50173, Acc. to EIA/TIA 568-A, Category 5, Flame-retardant acc. to IEC 60332-1-2, Halogen-free acc. to 60754-1, Oil-resistant, AWEM Style 20236 80°C/30V

Application

HELUKAT® 100T Category 5 Torsionflex is designed for applications with torsion loads, e.g. in robots, and characterized by high reserve capacity and outstanding performance, even after exposure to extreme conditions. Thanks to the clever structure, it is also possible to achieve a long service life mechanically.

Part no.

800067, SF/UTP 4x2xAWG 26/19 PUR (S-FTP)

Dimensions and specifications may be changed without prior notice.

BUS Cables

CAN Bus fixed installed 105°C

HELUKABEL

PVC



Type

Cable structure

Inner conductor diameter:
Core insulation:
Core colours:
Stranding element:
Separator:
Total shielding:
Outer sheath material:
Cable external diameter:
Outer sheath colour:

Industrial Area

2x2xAWG 24/ 19 mm² (stranded)

Copper, bare (AWG 24/ 19)
XLPE ray cross-linking
wh/bn, gn/ye
Double core
Polyester foil over stranded bundle
Cu braid, tinned
PUR
app. 8,4 mm ± 0,3 mm
Violet similar to RAL 4001

Electrical data

Characteristic impedance: 120 Ohm ± 10 %
Conductor resistance, max.: 87,2 Ohm/km
Insulation resistance, min.: 1 GOhm x km
Loop resistance: 174 Ohm/km max.
Mutual capacitance: 42 nF/km nom.
Nominal voltage: 600 V
Test voltage: 2,5 kV

Technical data

Weight: app. 80 kg/km
bending radius, repeated: 126 mm
Operating temperature range min.: -40°C
Operating temperature range max.: +105°C *
Caloric load, approx. value: 1,31 MJ/m
Copper weight: 40,00 kg/km

Norms

Applicable standards: CAN Bus acc. to ISO 11898-2
Halogen-free acc. to 60754-1
Flame-retardant acc. to IEC 60332-1-2
UL Style: UL/CSA 21223 80°C, 600V

Application

HELUKABEL® CAN Bus for fixed installation up to 105°C in difficult industrial environments with demanding temperature requirements thanks to cross-linking of the conductor insulation. Thanks to use a PUR sheath, this version is also halogen-free. For cable lengths up to max. 40m (observe CAN specifications).

Part no.

801982, CAN BUS

Dimensions and specifications may be changed without prior notice.

BUS Cables

Profibus SK fixed installed Indoor + Outdoor



PVC + PE

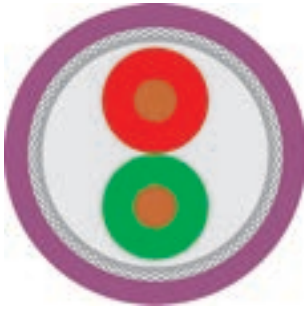

Type Cable structure

Inner conductor diameter:
Core insulation:
Core colours:
Stranding element:
Separator:
Inner sheath material:
Total shielding:
Outer sheath material:
Cable external diameter:
Outer sheath colour:

Fixed installation, indoor 1x2x0.64 mm

Copper, bare (AWG 22/ 1)
Foam-skin-PE
rd, gn
Double core
Polyester foil over stranded bundle
PVC
Cu braid, tinned
PVC
app. 8,0 mm ± 0,4 mm
Violet similar to RAL 4001

Fixed installation, outdoor 1x2x0.64 mm

Copper, bare (AWG 22/ 1)
Foam-skin-PE
rd, gn
Double core
Polyester foil over stranded bundle
PVC
Cu braid, tinned
PE
app. 8,0 mm ± 0,4 mm
Black similar to RAL 9005

Electrical data

Characteristic impedance:
Conductor resistance, max.:
Insulation resistance, min.:
Loop resistance:
Mutual capacitance:
Test voltage:
Attenuation:

150 Ohm ± 10 %
55 Ohm/km
1 GOhm x km
110 Ohm/km max.
35 nF/km nom.
1,5 kV
9,6 kHz < 2,5 dB/km
38,4 kHz < 4,0 dB/km
4,0 MHz < 22,0 dB/km
16,0 MHz < 42,0 dB/km

150 Ohm ± 10 %
55 Ohm/km
1 GOhm x km
110 Ohm/km max.
35 nF/km nom.
1,5 kV
9,6 kHz < 2,5 dB/km
38,4 kHz < 4,0 dB/km
4 MHz < 22,0 dB/km
16 MHz < 42,0 dB/km

Technical data

Weight:
bending radius, repeated:
Operating temperature range min.:
Operating temperature range max.:
Caloric load, approx. value:
Copper weight:

app. 79 kg/km
120 mm
-40°C
+80°C
1,068 MJ/m
24,00 kg/km

app. 65 kg/km
120 mm
-20°C
+70°C
1,451 MJ/m
24,00 kg/km

Norms

Applicable standards:

Profibus acc. to DIN 19245 T3 and EN50170
Flame-retardant acc. to IEC 60332-3
CMG 75°C or CL3 or AWM 21694 600V
CSA FT 4

Profibus acc. to DIN 19245 T3 and EN50170

UL Style:

-

CSA standard:

-

Application

HELUKABEL® Profibus SK Indoor + Outdoor have a special structure for processing with the Fast Connect Stripping Tool from Siemens. The indoor version is used for normal requirements in fixed installation applications in equipment; the Outdoor version is used in open-air applications, i.e. can withstand wind, weather and sun (not for burial directly in the ground).

Part no.

81903, Profibus SK

81904, Profibus SK

Dimensions and specifications may be changed without prior notice.

BUS Cables

Profibus L2 Torsion + Festoon

HELUKABEL

PUR + PVC



Type

Cable structure

Inner conductor diameter:
Core insulation:
Core colours:
Stranding element:
Separator:
Total shielding:
Outer sheath material:
Cable external diameter:
Outer sheath colour:

Torsional applications

1x2x0.80 mm (stranded)

Copper, bare (AWG 22/ 19)
Foam-skin-PE
rd, gn
2 cores + filler
Polyester foil over stranded bundle
Cu braid, tinned
PUR
app. 8,0 mm ± 0,4 mm
Violet similar to RAL 4001

Mobile use

1x2x0.65 mm (stranded)

Copper, bare (AWG 23/ 19)
Cell PE
rd, gn
2 cores + 2 fillers stranded together
Polyester foil over stranded bundle
Cu braid, tinned
PVC
app. 8,0 mm ± 0,3 mm
Petrol similar to RAL 5018

Electrical data

Characteristic impedance:
Conductor resistance, max.:
Insulation resistance, min.:
Loop resistance:
Mutual capacitance:
Test voltage:
Relative propagation velocity:
Attenuation:

150 Ohm ± 10 %
49 Ohm/km
1,6 GOhm x km
98 Ohm/km max.
29 nF/km nom.
3,6 kV
-
9,6 kHz < 2,5 dB/km
38,4 kHz < 3,0 dB/km
4 MHz < 25,0 dB/km
16 MHz < 49,0 dB/km

150 Ohm ± 10 %
66,5 Ohm/km
1,6 GOhm x km
133 Ohm/km max.
28 nF/km nom.
2 kV
81 %
9,6 kHz ≤ 3,0 dB/km
38,4 kHz ≤ 4,0 dB/km
4 MHz ≤ 25,0 dB/km
16 MHz ≤ 49,0 dB/km

Technical data

Weight:
bending radius, repeated:
Operating temperature range min.:
Operating temperature range max.:
Caloric load, approx. value:
Copper weight:

app. 66 kg/km
100 mm
-25°C
+75°C
0,89 MJ/m
32,00 kg/km

app. 64 kg/km
70 mm
-40°C
+60°C
1,09 MJ/m
23,00 kg/km

Norms

Applicable standards:

Profibus acc. to DIN 19245 T3 and EN50170
Halogen-free acc. to 60754-1
Flame-retardant acc. to IEC 60332-1-2
CMX 75°C (shielded)
-

Profibus acc. to DIN 19245 T3 and EN50170
Flame-retardant acc. to EN 50265-2-1

UL Style:

CSA standard:

CMG 75°C or CL2 or AWM 20201 600V
CSA FT 4

Application

HELUKABEL® Profibus Torsion is used in mobile applications in robots. The special torsion construction allows this cable to be twisted (torsioned) and is halogen-free thanks to use PU sheath. The Festoon version is used for hanging/moving loads in garland applications.

Part no.

800109, Profibus L2

800649, Profibus L2

Dimensions and specifications may be changed without prior notice.

BUS Cables

Profibus SK fixed installed FRNC + Robust



FRNC + PUR

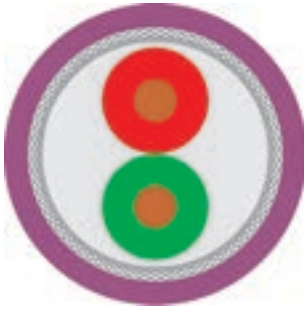

Type Cable structure

Inner conductor diameter:
Core insulation:
Core colours:
Stranding element:
Separator:
Inner sheath material:
Total shielding:
Outer sheath material:
Cable external diameter:
Outer sheath colour:

Fixed installation, indoor 1x2x0.64 mm

Copper, bare (AWG 22/ 1)
Foam-skin-PE
rd, gn
Double core
Polyester foil over stranded bundle
FRNC
Cu braid, tinned
FRNC
app. 8,0 mm ± 0,4 mm
Violet similar to RAL 4001

Industrial Area 1x2x0.64 mm

Copper, bare (AWG 22/ 1)
Foam-skin-PE
rd, gn
Double core
Polyester foil over stranded bundle
FRNC
Cu braid, tinned
PUR
app. 8,0 mm ± 0,4 mm
Violet similar to RAL 4001

Electrical data

Characteristic impedance:
Conductor resistance, max.:
Insulation resistance, min.:
Loop resistance:
Mutual capacitance:
Test voltage:
Attenuation:

150 Ohm ± 10 %
55 Ohm/km
1 GOhm x km
110 Ohm/km max.
35 nF/km nom.
1,5 kV
9,6 kHz < 2,5 dB/km
38,4 kHz < 4,0 dB/km
4 MHz < 22,0 dB/km
16 MHz < 42,0 dB/km

150 Ohm ± 10 %
55 Ohm/km
1 GOhm x km
110 Ohm/km max.
35 nF/km nom.
1,5 kV
9,6 kHz < 2,5 dB/km
38,4 kHz < 4,0 dB/km
4 MHz < 22,0 dB/km
16 MHz < 42,0 dB/km

Technical data

Weight:
bending radius, repeated:
Operating temperature range min.:
Operating temperature range max.:
Caloric load, approx. value:
Copper weight:

app. 73 kg/km
160 mm
-25°C
+70°C
1,203 MJ/m
24,00 kg/km

app. 71 kg/km
120 mm
-40°C
+70°C
1,574 MJ/m
24,00 kg/km

Norms

Applicable standards:

Profibus acc. to DIN 19245 T3 and EN50170
Halogen-free acc. to 60754-1
Flame-retardant acc. to EN 50265-2-1
CM 750C (shielded)

UL Style:

Profibus acc. to DIN 19245 T3 and EN50170
Halogen-free acc. to 60754-1
Flame-retardant acc. to IEC 60332-1-2
AWM Style 20236 AWM I/II A/B 80°C 30V
FT1
CSA FT1

CSA standard:

Application

HELUKABEL® Profibus SK FRNC + Robust has a special structure for processing with the Fast Connect Stripping Tool from Siemens. The FRNC version is used to satisfy halogen-free and flame-retardent requirements in buildings. The Robust version is used in harsh industrial environments and offers excellent resistance to mineral oils, greases and cooling lubricants.

Part no.

81501, Profibus SK

81905, Profibus SK

Dimensions and specifications may be changed without prior notice.

Fibre Optic Cable flexible

WK robust PUR + PVC (UL/CSA)

HELUCOM® WK

AT-V(ZN)H(ZN)11Y, AT-V(ZN)Y(ZN)Y



Cable structure

Core type: Composite buffered
Strain relief elements: Aramide
Outer sheath colour: Black

Temperature range

Laying, min.: -10°C
Laying, max.: +50°C
Operating, min.: -40°C
Operating, max.: +90°C

Other data

Max. tensile force: 4800 N
Max. transverse pressure: 200 N / cm
Longitudinally water-tight acc. to IEC 60794-1-2-F5
UV-resistant
Resistant to hammer impact acc. to IEC 60794-1-2-E4
Bending cycles acc. to IEC 60794-1-2-E6: 9.000
Oil-resistant

Designation	Number of fibres	Fibre type	Fibre category	Outer Ø app. mm	Outer sheath material	Inner sheath material	Min. stat. bending radius mm	Flame proof	halogen-free	UL	Weight kg / km	Part no.
AT-V(ZN)H(ZN)11Y	4	Multimode G50/125	OM2	8,5	PUR	ULSZH	100	yes	yes	no	125	803346
AT-V(ZN)Y(ZN)Y	4	Multimode G50/125	OM2	8,5	PVC	PVC	130	yes	no	yes	125	803348
AT-V(ZN)H(ZN)11Y	12	Multimode G50/125	OM2	12,4	PUR	ULSZH	190	yes	yes	no	320	803347
AT-V(ZN)H(ZN)11Y	12	Single-mode E9/125	ITU-T G.652	12,4	PUR	ULSZH	190	yes	yes	no	320	804700
AT-V(ZN)Y(ZN)Y	12	Multimode G50/125	OM2	12,4	PVC	PVC	190	yes	no	yes	320	803349

Dimensions and specifications may be changed without prior notice.

Application

The HELUCOM® WK range is set apart by its extreme rugged yet highly-flexible design. It is used wherever demanding environmental conditions and extreme movements occur. The tight buffer structure enables the cable to be pre-assembled on site with ease. Applications are for example Windturbines, TV transmissions, mobile field applications, etc.

Fibre Optic Cable flexible

WK - mobile

HELUCOM®

A-V(ZN)11Y

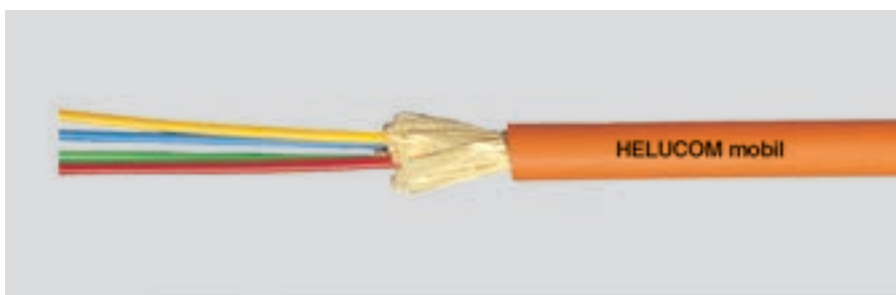

Cable structure

Core type: Tight buffer
Strain relief elements: Aramide
Outer sheath colour: Orange

Temperature range

Laying, min.: +5°C
Laying, max.: +50°C
Operating, min.: -30°C
Operating, max.: +70°C

Other data

Max. tensile force: 650 N
Max. transverse pressure: 40 N / cm
Longitudinally water-tight acc. to IEC 60794-1-2-F5
UV-resistant
Resistant to hammer impact acc. to IEC 60794-1-2-E4
Bending cycles acc. to IEC 60794-1-2-E6: 500.000
Oil-resistant

Designation	Number of fibres	Fibre type	Fibre category	Outer Ø app. mm	Outer sheath material	Min. stat. bending radius mm	Flame proof	halogen-free	UL	Weight kg / km	Part no.
Fibre-optic cable	2	Multimode G50/125	OM2	5,0	PUR	75	yes	yes	no	20	80382
Fibre-optic cable	2	Multimode G62.5/125	OM1	5,0	PUR	75	yes	yes	no	20	80363
Fibre-optic cable	4	Multimode G50/125	OM2	5,8	PUR	90	yes	yes	no	31	80534
Fibre-optic cable	4	Multimode G62.5/125	OM1	5,8	PUR	90	yes	yes	no	31	81036
Fibre-optic cable	4	Single-mode E9/125	ITU-T G.652	5,8	PUR	90	yes	yes	no	31	801727
Fibre-optic cable	8	Multimode G50/125	OM2	7,0	PUR	105	yes	yes	no	47	81037
Fibre-optic cable	8	Multimode G62.5/125	OM1	7,0	PUR	105	yes	yes	no	47	81038

Dimensions and specifications may be changed without prior notice.

Application

These HELUCOM® cables were designed as mobile field cables. They are easily wound up on a drum and are very tension-proof. As the outer sheath is tightly anchored on the aramid braiding, it is especially suitable for mobile use. The advantage of these cables is evident especially where mobile fibre-optic lines are to be installed, such as for drag chains, TV transmission, supervision of protected areas, etc.

Fibre Optic Cable flexible

WK - UL/CSA

HELUCOM® WK

A-V(ZN)YY

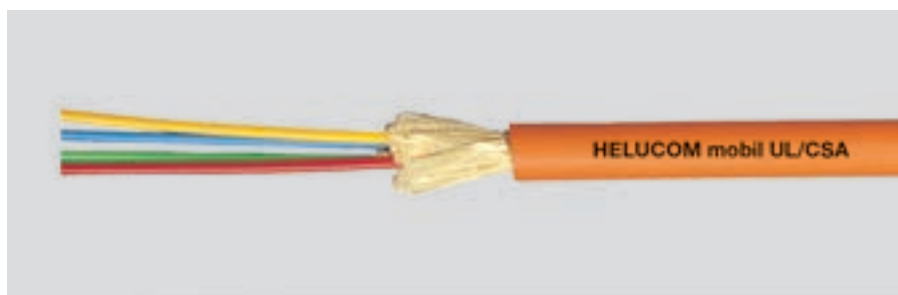

Cable structure

Core type: Tight buffer
Strain relief elements: Aramide
Outer sheath colour: Orange

Temperature range

Laying, min.: 0°C
Laying, max.: +50°C
Operating, min.: -30°C
Operating, max.: +80°C

Other data

Max. tensile force: 1200 N
Max. transverse pressure: 44 N / cm
Longitudinally water-tight acc. to IEC 60794-1-2-F5
Applicable UL standards: OFNG UL 1685
Applicable CSA standards: FT4
UV-resistant
Bending cycles acc. to IEC 60794-1-2-E6: 9.000
Oil-resistant

Designation	Number of fibres	Fibre type	Fibre category	Outer Ø app. mm	Outer sheath material	Inner sheath material	Min. stat. bending radius mm	Flame proof	halogen-free	UL	Weight kg / km	Part no.
Fibre-optic cable	4	Multimode G50/125	OM2	7,0	PVC	PVC	75	yes	no	yes	50	802792
Fibre-optic cable	4	Multimode G62.5/125	OM1	7,0	PVC	PVC	75	yes	no	yes	50	803934
Fibre-optic cable	4	Single-mode E9/125	ITU-T G.652	7,0	PVC	PVC	75	yes	no	yes	50	803935

Dimensions and specifications may be changed without prior notice.

Application

These HELUCOM® cables were designed as mobile field cables. They are easily wound up on a drum and are very tension-proof. As the outer sheath is tightly anchored on the aramid braiding, it is especially suitable for mobile use. The advantage of these cables is obvious especially where mobile fibre-optic lines have to be installed, such as windturbine projects, TV transmission, supervision of protected areas, etc. This series with PVC jacket is certified according to the **UL/CSA standard OFNG/ FT4**.

Fibre Optic Breakout Cable robust, flexible

HCS UL/CSA

HELUCOM

I-V(ZN)YY



Cable structure

Core type: Composite buffered
Strain relief elements: Aramide
Outer sheath material: PVC
Outer sheath colour: Black

Temperature range

Laying, min.: -20°C
Laying, max.: +75°C
Operating, min.: -30°C
Operating, max.: +85°C

Other data

Flame-resistance acc. to IEC 60332-1 and IEC 60332-3
Applicable UL standards: OFNG UL 1685
Applicable CSA standards: FT4
UV-resistant
Oil-resistant

Designation	Number of fibres	Fibre type	Fibre category	Number of fibres per core	Outer Ø app. mm	Max. tensile force N	Min. stat. bending radius mm	Max. transverse pressure N / cm	Caloric load app. MJ / m	Weight kg / km	Part no.
I-V(ZN)YY	2	HCS 200/230	Other	1	7,5	800	100,0	300	1,40	68,0	801733

Dimensions and specifications may be changed without prior notice.

Application

This HELUCOM® HCS fibre cable is suitable for fixed and normal flexible installations. Possible applications are normal and heavy-duty mechanical requirements for example in industrial environments. Because of a special PVC jacket this construction is certified by UL (FT1 and FT4). With the tight buffer construction, direct plug manufacturing, even on site, poses no problems. With a HCS fibre transmission lengths of up to 300m can be achieved.

Fibre Optic Breakout Cable robust, flexible

HCS

HELUCOM®

I-V(ZN)Y11Y



Cable structure

Core type: Composite buffered
Strain relief elements: Aramide
Outer sheath material: PUR
Outer sheath colour: Red

Temperature range

Laying, min.: -5°C
Laying, max.: +50°C
Operating, min.: -20°C
Operating, max.: +70°C

Other data

Oil-resistant

Designation	Number of fibres	Fibre type	Fibre category	Number of fibres per core	Outer Ø app. mm	Max. tensile force N	Min. stat. bending radius mm	Max. transverse pressure N / cm	Caloric load app. MJ / m	Weight kg / km	Part no.
I-V(ZN)Y11Y	2	HCS 200/230	Other	1	7,0	800	50,0	150	1,014	43,0	800980

Dimensions and specifications may be changed without prior notice.

Application

This HELUCOM® HCS fibre cable is suitable for fixed installation. Possible applications are normal and heavy-duty mechanical requirements for example in industrial environments. With the tight buffer construction, direct plug manufacturing, even on site, poses no problems. With a HCS fibre transmission lengths of up to 300m can be achieved.

Plastic Fibre Cable PROFinet

POF/PA

HELUCOM®

I-V4Y(ZN)Y (type B), I-V4Y(ZN)11Y (type C)



Cable structure

Fibre type: POF 980/1000
Fibre cladding: PA

Optical characteristic

Refractive index core: 1,492
Refractive index cladding: 1,419
Numerical aperture: 0,5
Attenuation see table

Temperature range

Laying, min.: -10°C
Laying, max.: +50°C
Operating, min.: -30°C
Operating, max.: +70°C

Designation	Outer sheath material	Sheath colour	Outer Ø app. mm	Max. tensile force N	Min. stat. bending radius mm	Fibre attenuation	Oil-resistant	Acc. to DESINA®	Weight kg / km	Part no.
I-V4Y(ZN)Y 2P980/1000µm, fixed installation	PVC	Green	7,8	100	100,0	160A1	yes	no	59,0	805686
I-V4Y(ZN)11Y 2P980/1000 green, drag chain	PUR	Green	8,0	200	120,0	230A1	yes	no	60,0	805838

Dimensions and specifications may be changed without prior notice.

Application

Signal lines as plastic optical fibre. The use of these transmission systems significantly reduces the number of different cables in a planned bus installation in machine tools operations. Furthermore, possible EMC problems are prevented by the metal-free construction. The main fields of these cables are in machine construction and automobile industry. Installations for example in fixed installed rough areas (type B) or in drag chains (type C) are possible. The types on this page are especially constructed for communication within PROFinet systems.

Plastic Fibre Cable PROFIBUS

POF/PA

HELUCOM[®]

I-V4Y(ZN)Y



Cable structure

Fibre type: POF 980/1000
Fibre cladding: PA

Optical characteristic

Refractive index core: 1,492
Refractive index cladding: 1,419
Numerical aperture: 0,5
Attenuation see table

Temperature range

Laying, min.: -10°C
Laying, max.: +50°C
Operating, min.: -30°C
Operating, max.: +70°C

Designation	Outer sheath material	Sheath colour	Outer Ø app. mm	Max. tensile force N	Min. stat. bending radius mm	Fibre attenuation	Oil-resistant	Acc. to DESINA [®]	Weight kg / km	Part no.
I-V4Y(ZN)Y 2P980/1000µm, fixed installation	PVC	Violet	7,8	100	100,0	160A1	yes	yes	59,0	801280

Dimensions and specifications may be changed without prior notice.

Application

Signal lines as plastic optical fibre. The use of these transmission systems significantly reduces the number of different cables in a planned bus installation in machine tools operations. Furthermore, possible EMC problems are prevented by the metal-free construction. The main application of these cables are in machine construction and automobile industry. The type on this page is especially constructed for communication within PROFIBUS systems.

Plastic Fibre cable industry

POF/PE

HELUCOM®

I-V2Y, I-V2Y(ZN)11Y



Cable structure

Fibre type: POF 980/1000
Fibre cladding: PE

Optical characteristic

Refractive index core: 1,492
Refractive index cladding: 1,419
Numerical aperture: 0,5
Attenuation see table

Temperature range

Laying, min.: -20°C
Laying, max.: +80°C
Operating, min.: -20°C
Operating, max.: +80°C

Designation	Outer sheath material	Sheath colour	Outer Ø app. mm	Max. tensile force N	Min. stat. bending radius mm	Fibre attenuation	Oil-resistant	Acc. to DESINA®	Weight kg / km	Part no.
I-V2Y 1P 980/1000	PE	Black	2,2	70	25,0	160A1	no	no	4,0	80532
I-V2Y 2P 980/1000	PE	Black	2,2 x 4,4	140	25,0	160A1	no	no	8,0	80388
I-V2Y(ZN)11Y 1P 980/1000, high flexible	PUR	Violet	5,8	400	30,0	230A1	yes	yes	30,0	81611
I-V2Y(ZN)11Y 2P 980/1000, high flexible	PUR	Violet	6,0	400	31,0	230A1	yes	yes	36,0	80629
I-V2Y(ZN)11Y 2P 980/1000, fixed installation	PUR	Violet	6,0	400	31,0	230A1	yes	yes	36,0	81882
I-V2Y(ZN)11Y 4P 980/1000, high flexible	PUR	Violet	7,1	400	45,0	230A1	yes	yes	65,0	80630
I-V2Y(ZN)11Y 2P 980/1000 + 2x1mm ² Cu	PUR	Red	7,8	200	70,0	230A1	yes	no	60,0	82032
I-V2Y(ZN)11Y 2P 980/1000 + 3x1,5mm ² Cu	PUR	Red	11,0	200	70,0	230A1	yes	no	132,0	82033

Dimensions and specifications may be changed without prior notice.

Application

HELUCOM® plastic-fibre cables are used in mechanical engineering, both in mobile and fixed applications. With different constructions, such as PUR outer sheaths, special strain relief components, hybrid construction with copper cores for power supply or only raw fibre cables, any possible fields of application are covered. Due to their solidity and their simple adjustability on site, the plastic-fibres (PMMA) are particularly suitable for applications where trouble-free data transmission is necessary under heavy-duty conditions.

Fibre Optic Indoor/Outdoor Cable

acc. DIN VDE 0888

HELUCOM

A/I-DQ(ZN)BH, central



Cable structure

Core type: Loose tube
Strain relief elements: Glass yarns
Type of armouring: Glass yarns
Outer sheath material: FRNC
Outer sheath colour: Black

Temperature range

Laying, min.: -5°C
Laying, max.: +50°C
Operating, min.: -20°C
Operating, max.: +60°C

Other data

Corrosiveness acc. to EN50267-2-3
Halogen-free acc. to 60754-2
Flame-resistance acc. to IEC 60332-1-2
Smoke density acc. to IEC 61034
Longitudinally water-tight acc. to IEC 60794-1-2-F5
UV-resistant

Designation	No. of fibres	Fibre type	Fibre category	Number of fibres per core	Outer Ø app. mm	Max. tensile force N	Min. stat. bending radius mm	Caloric load app. MJ / m	Max. transverse pressure N / cm	Weight kg / km	Part no.
A/I-DQ(ZN)BH	4	Multimode G50/125	OM2	4	10,0	2500	150,0	1,50	300	75,0	80270
A/I-DQ(ZN)BH	4	Multimode G62.5/125	OM1	4	10,0	2500	150,0	1,50	300	75,0	80276
A/I-DQ(ZN)BH	4	Single-mode E9/125	ITU-T G.652	4	10,0	2500	150,0	1,50	300	75,0	80264
A/I-DQ(ZN)BH	6	Multimode G50/125	OM2	6	10,0	2500	150,0	1,50	300	75,0	80271
A/I-DQ(ZN)BH	6	Multimode G62.5/125	OM1	6	10,0	2500	150,0	1,50	300	75,0	80265
A/I-DQ(ZN)BH	6	Single-mode E9/125	ITU-T G.652	6	10,0	2500	150,0	1,50	300	75,0	80272
A/I-DQ(ZN)BH	8	Multimode G50/125	OM2	8	10,0	2500	150,0	1,50	300	75,0	80273
A/I-DQ(ZN)BH	8	Multimode G62.5/125	OM1	8	10,0	2500	150,0	1,50	300	75,0	80274
A/I-DQ(ZN)BH	8	Single-mode E9/125	ITU-T G.652	8	10,0	2500	150,0	1,50	300	75,0	80275
A/I-DQ(ZN)BH	12	Multimode G50/125	OM2	12	10,0	2500	150,0	1,50	300	75,0	80681
A/I-DQ(ZN)BH	12	Multimode G62.5/125	OM1	12	10,0	2500	150,0	1,50	300	75,0	80278
A/I-DQ(ZN)BH	12	Single-mode E9/125	ITU-T G.652	12	10,0	2500	150,0	1,50	300	75,0	80279
A/I-DQ(ZN)BH	16	Multimode G50/125	OM2	16	10,0	2500	150,0	1,50	300	85,0	80280
A/I-DQ(ZN)BH	16	Multimode G62.5/125	OM1	16	10,0	2500	150,0	1,50	300	85,0	80281
A/I-DQ(ZN)BH	16	Single-mode E9/125	ITU-T G.652	16	10,0	2500	150,0	1,50	300	85,0	80851
A/I-DQ(ZN)BH	24	Multimode G50/125	OM2	24	10,0	2500	150,0	1,50	300	85,0	80725
A/I-DQ(ZN)BH	24	Multimode G62.5/125	OM1	24	10,0	2500	150,0	1,50	300	85,0	82431

Dimensions and specifications may be changed without prior notice.

Application

These HELUCOM® fibre-optic cables are available either as central bundle core cable or as stranded versions. They are suitable for indoor and outdoor cabling of buildings and facilities. They are used in particular if the installation is to be done in one piece from the inside to the outside without additional use of couplings. With their black UV-resistant outer sheath and the non-metallic rodent protection, they are perfectly suited for outdoor use. The halogen-free outer sheath makes installation inhouse possible without any problems.

Fibre Optic Outdoor Cable

acc. DIN VDE 0888

HELUCOM[®] pact

A-DQ(ZN)B2Y, central



Cable structure

Core type: Loose tube
Strain relief elements: Glass yarns
Type of armouring: Glass yarns
Outer sheath material: PE
Outer sheath colour: Black

Temperature range

Laying, min.: -5°C
Laying, max.: +50°C
Operating, min.: -20°C
Operating, max.: +60°C

Other data

Corrosiveness acc. to EN50267-2-3
Halogen-free acc. to 60754-2
Longitudinally water-tight acc. to IEC 60794-1-2-F5
UV-resistant

Designation	No. of fibres	Fibre type	Fibre category	Number of fibres per core	Outer Ø app. mm	Max. tensile force N	Min. stat. bending radius mm	Caloric load app. MJ / m	Max. transverse pressure N / cm	Weight kg / km	Part no.
A-DQ(ZN)B2Y	2	Multimode G50/125	OM2	2	7,5	1500	150,0	1,60	300	40,0	800754
A-DQ(ZN)B2Y	2	Multimode G62.5/125	OM1	2	7,5	1500	150,0	1,60	300	40,0	802131
A-DQ(ZN)B2Y	2	Single-mode E9/125	ITU-T G.652	2	7,5	1500	150,0	1,60	300	40,0	802137
A-DQ(ZN)B2Y	4	Multimode G50/125	OM2	4	7,5	1500	150,0	1,60	300	40,0	800755
A-DQ(ZN)B2Y	4	Multimode G62.5/125	OM1	4	7,5	1500	150,0	1,60	300	40,0	802132
A-DQ(ZN)B2Y	4	Single-mode E9/125	ITU-T G.652	4	7,5	1500	150,0	1,60	300	40,0	802138
A-DQ(ZN)B2Y	6	Multimode G50/125	OM2	6	7,5	1500	150,0	1,60	300	40,0	800756
A-DQ(ZN)B2Y	6	Multimode G62.5/125	OM1	6	7,5	1500	150,0	1,60	300	40,0	802133
A-DQ(ZN)B2Y	6	Single-mode E9/125	ITU-T G.652	6	7,5	1500	150,0	1,60	300	40,0	802139
A-DQ(ZN)B2Y	8	Multimode G50/125	OM2	8	7,5	1500	150,0	1,60	300	40,0	800757
A-DQ(ZN)B2Y	8	Multimode G62.5/125	OM1	8	7,5	1500	150,0	1,60	300	40,0	802134
A-DQ(ZN)B2Y	8	Single-mode E9/125	ITU-T G.652	8	7,5	1500	150,0	1,60	300	40,0	802140
A-DQ(ZN)B2Y	12	Multimode G50/125	OM2	12	7,5	1500	150,0	1,60	300	40,0	800759
A-DQ(ZN)B2Y	12	Multimode G62.5/125	OM1	12	7,5	1500	150,0	1,60	300	40,0	802135
A-DQ(ZN)B2Y	12	Single-mode E9/125	ITU-T G.652	12	7,5	1500	150,0	1,60	300	40,0	802141
A-DQ(ZN)B2Y	24	Multimode G50/125	OM2	24	8,5	1500	170,0	1,90	300	60,0	800762
A-DQ(ZN)B2Y	24	Multimode G62.5/125	OM1	24	8,5	1500	170,0	1,90	300	60,0	802136
A-DQ(ZN)B2Y	24	Single-mode E9/125	ITU-T G.652	24	8,5	1500	170,0	1,90	300	60,0	802142

Dimensions and specifications may be changed without prior notice.

Application

These HELUCOM[®] pact fibre-optic cables are characterized by a design that is particularly easy to mount and is rodent-protected. Around a central grooved cable, there is a composite of glass yarns and swelling fleece with characteristics that ensure rodent protection, strain relief, and waterproofing in longitudinal direction of the cable. In addition, these cables are designed grease-free. Wiping the jelly off is therefore unnecessary. This construction is particularly used in underground, tubes and channel areas, where normal tensile stresses and/or transverse compressions occur and rodent infestation is to be expected.

Fibre Optic Outdoor Cable

acc. DIN VDE 0888

HELUCOM

A-DQ(ZN)B2Y, central



Cable structure

Core type: Loose tube
Strain relief elements: Glass yarns
Type of armouring: Glass yarns
Outer sheath material: PE
Outer sheath colour: Black

Temperature range

Laying, min.: -5°C
Laying, max.: +50°C
Operating, min.: -20°C
Operating, max.: +60°C

Other data

Corrosiveness acc. to EN50267-2-3
Halogen-free acc. to 60754-2
Longitudinally water-tight acc. to IEC 60794-1-2-F5
UV-resistant

Designation	No. of fibres	Fibre type	Fibre category	Number of fibres per core	Outer Ø app. mm	Max. tensile force N	Min. stat. bending radius mm	Caloric load app. MJ / m	Max. transverse pressure N / cm	Weight kg / km	Part no.
A-DQ(ZN)B2Y	2	Multimode G50/125	OM2	2	10,0	2700	160,0	1,60	300	85,0	80196
A-DQ(ZN)B2Y	2	Multimode G62.5/125	OM1	2	10,0	2700	160,0	1,60	300	85,0	80212
A-DQ(ZN)B2Y	2	Single-mode E9/125	ITU-T G.652	2	10,0	2700	160,0	1,60	300	85,0	80180
A-DQ(ZN)B2Y	4	Multimode G50/125	OM2	4	10,0	2700	160,0	1,60	300	85,0	80197
A-DQ(ZN)B2Y	4	Multimode G62.5/125	OM1	4	10,0	2700	160,0	1,60	300	85,0	80213
A-DQ(ZN)B2Y	4	Single-mode E9/125	ITU-T G.652	4	10,0	2700	160,0	1,60	300	85,0	80181
A-DQ(ZN)B2Y	6	Multimode G50/125	OM2	6	10,0	2700	160,0	1,60	300	85,0	80198
A-DQ(ZN)B2Y	6	Multimode G62.5/125	OM1	6	10,0	2700	160,0	1,60	300	85,0	80214
A-DQ(ZN)B2Y	6	Single-mode E9/125	ITU-T G.652	6	10,0	2700	160,0	1,60	300	85,0	80182
A-DQ(ZN)B2Y	8	Multimode G50/125	OM2	8	10,0	2700	160,0	1,60	300	85,0	80199
A-DQ(ZN)B2Y	8	Multimode G62.5/125	OM1	8	10,0	2700	160,0	1,60	300	85,0	80215
A-DQ(ZN)B2Y	8	Single-mode E9/125	ITU-T G.652	8	10,0	2700	160,0	1,60	300	85,0	80183
A-DQ(ZN)B2Y	12	Multimode G50/125	OM2	12	10,0	2700	160,0	1,60	300	85,0	80201
A-DQ(ZN)B2Y	12	Multimode G62.5/125	OM1	12	10,0	2700	160,0	1,60	300	85,0	80217
A-DQ(ZN)B2Y	12	Single-mode E9/125	ITU-T G.652	12	10,0	2700	160,0	1,60	300	85,0	80185
A-DQ(ZN)B2Y	16	Multimode G50/125	OM2	16	10,0	2700	180,0	1,80	300	95,0	80202
A-DQ(ZN)B2Y	16	Multimode G62.5/125	OM1	16	10,0	2700	180,0	1,80	300	95,0	80218
A-DQ(ZN)B2Y	16	Single-mode E9/125	ITU-T G.652	16	10,0	2700	180,0	1,80	300	95,0	80186
A-DQ(ZN)B2Y	24	Multimode G50/125	OM2	24	10,0	2700	180,0	1,80	300	95,0	80204
A-DQ(ZN)B2Y	24	Multimode G62.5/125	OM1	24	10,0	2700	180,0	1,80	300	95,0	80220
A-DQ(ZN)B2Y	24	Single-mode E9/125	ITU-T G.652	24	10,0	2700	180,0	1,80	300	95,0	80187

Dimensions and specifications may be changed without prior notice.

Application

These HELUCOM® fibre-optic cables are characterized by a design that is particularly easy to mount and is rodent-protected. Around a central grooved cable, there is a composite of glass yarns and swelling fleece with characteristics that ensure rodent protection, strain relief, and waterproofing in longitudinal direction of the cable. In addition, these cables are designed grease-free. Wiping the jelly off is therefore unnecessary. This construction is particularly used in underground, tubes and channel areas, where normal tensile stresses and/or transverse compressions occur and rodent infestation is to be expected.

Fibre Optic Outdoor Cable

acc. DIN VDE 0888

HELUCOM®

A-DQ(ZN)B2Y, stranded



Cable structure

Core type: Loose tube
GRP support element
Strain relief elements: Glass yarns
Type of armouring: Glass yarns
Outer sheath material: PE
Outer sheath colour: Black

Temperature range

Laying, min.: -5°C
Laying, max.: +50°C
Operating, min.: -20°C
Operating, max.: +60°C

Other data

Corrosiveness acc. to EN50267-2-3
Halogen-free acc. to 60754-2
Longitudinally water-tight acc. to IEC 60794-1-2-F5
UV-resistant

Designation	No. of fibres	Fibre type	Fibre category	Number of fibres per core	Outer Ø app. mm	Max. tensile force N	Min. stat. bending radius mm	Caloric load app. MJ / m	Max. transverse pressure N / cm	Weight kg / km	Part no.
A-DQ(ZN)B2Y	24	Multimode G50/125	OM2	12	10,5	2700	210,0	2,70	600	95,0	81382
A-DQ(ZN)B2Y	24	Multimode G62.5/125	OM1	12	10,5	2700	210,0	2,70	600	95,0	80219
A-DQ(ZN)B2Y	24	Single-mode E9/125	ITU-T G.652	12	10,5	2700	210,0	2,70	600	95,0	80188
A-DQ(ZN)B2Y	36	Multimode G50/125	OM2	12	10,5	2700	210,0	2,70	600	95,0	81108
A-DQ(ZN)B2Y	36	Multimode G62.5/125	OM1	12	10,5	2700	210,0	2,70	600	95,0	81109
A-DQ(ZN)B2Y	36	Single-mode E9/125	ITU-T G.652	12	10,5	2700	210,0	2,70	600	95,0	81110
A-DQ(ZN)B2Y	48	Multimode G50/125	OM2	12	10,5	2700	210,0	2,70	600	95,0	82648
A-DQ(ZN)B2Y	48	Multimode G62.5/125	OM1	12	10,5	2700	210,0	2,70	600	95,0	81112
A-DQ(ZN)B2Y	48	Single-mode E9/125	ITU-T G.652	12	10,5	2700	210,0	2,70	600	95,0	81113
A-DQ(ZN)B2Y	60	Multimode G50/125	OM2	12	10,5	2700	210,0	2,70	600	95,0	80207
A-DQ(ZN)B2Y	60	Multimode G62.5/125	OM1	12	10,5	2700	210,0	2,70	600	95,0	80223
A-DQ(ZN)B2Y	60	Single-mode E9/125	ITU-T G.652	12	10,5	2700	210,0	2,70	600	95,0	80191
A-DQ(ZN)B2Y	72	Multimode G50/125	OM2	12	11,0	2700	220,0	2,90	600	100,0	81133
A-DQ(ZN)B2Y	72	Multimode G62.5/125	OM1	12	11,0	2700	220,0	2,90	600	100,0	81134
A-DQ(ZN)B2Y	72	Single-mode E9/125	ITU-T G.652	12	11,0	2700	220,0	2,90	600	100,0	81120
A-DQ(ZN)B2Y	84	Multimode G50/125	OM2	12	12,0	3000	240,0	3,60	600	140,0	80208
A-DQ(ZN)B2Y	84	Multimode G62.5/125	OM1	12	12,0	3000	240,0	3,60	600	140,0	80224
A-DQ(ZN)B2Y	84	Single-mode E9/125	ITU-T G.652	12	12,0	3000	240,0	3,60	600	140,0	80192
A-DQ(ZN)B2Y	96	Multimode G50/125	OM2	12	12,0	3000	240,0	3,60	600	140,0	81135
A-DQ(ZN)B2Y	96	Multimode G62.5/125	OM1	12	12,0	3000	240,0	3,60	600	140,0	81136
A-DQ(ZN)B2Y	96	Single-mode E9/125	ITU-T G.652	12	12,0	3000	240,0	3,60	600	140,0	81121
A-DQ(ZN)B2Y	108	Multimode G50/125	OM2	12	13,5	3000	270,0	4,30	600	155,0	80209
A-DQ(ZN)B2Y	108	Multimode G62.5/125	OM1	12	13,5	3000	270,0	4,30	600	155,0	80225
A-DQ(ZN)B2Y	108	Single-mode E9/125	ITU-T G.652	12	13,5	3000	270,0	4,30	600	155,0	80193
A-DQ(ZN)B2Y	120	Multimode G50/125	OM2	12	13,5	3000	270,0	4,30	600	155,0	80210
A-DQ(ZN)B2Y	120	Multimode G62.5/125	OM1	12	13,5	3000	270,0	4,30	600	155,0	80226
A-DQ(ZN)B2Y	120	Single-mode E9/125	ITU-T G.652	12	13,5	3000	270,0	4,30	600	155,0	80194
A-DQ(ZN)B2Y	144	Multimode G50/125	OM2	12	14,5	3000	290,0	5,40	600	200,0	80211
A-DQ(ZN)B2Y	144	Multimode G62.5/125	OM1	12	14,5	3000	290,0	5,40	600	200,0	80227
A-DQ(ZN)B2Y	144	Single-mode E9/125	ITU-T G.652	12	14,5	3000	290,0	5,40	600	200,0	80195

Dimensions and specifications may be changed without prior notice.

Application

These HELUCOM® fibre-optic cables are characterized by a design that is particularly easy to mount, extremely tension-resistant and rodent-proof. Around a stranded grooved cable and filler elements, there is a composite of glass yarns and swelling fleece with characteristics that ensure rodent protection, strain relief, and waterproofing in longitudinal direction of the cable. In addition, these cables are designed grease-free. Wiping the jelly off is therefore unnecessary. This construction is particularly used in underground, tubes and channel areas, where above-average tensile stresses and/or transverse compressions occur and rodent infestation is to be expected.

Fibre Optic Outdoor Cable

acc. DIN VDE 0888

HELUCOM[®] pact

A-DQ(ZN)B2Y fibre combi, stranded



Cable structure

Core type: Loose tube
 GRP support element
 Strain relief elements: Glass yarns
 Type of armouring: Glass yarns
 Outer sheath material: PE
 Outer sheath colour: Black

Temperature range

Laying, min.: -5°C
 Laying, max.: +50°C
 Operating, min.: -20°C
 Operating, max.: +60°C

Other data

Corrosiveness acc. to EN50267-2-3
 Longitudinally water-tight acc. to IEC 60794-1-2-F5
 UV-resistant

Designation	No. of fibres	Fibre type	Fibre category	Number of fibres per core	Outer Ø app. mm	Max. tensile force N	Min. stat. bending radius mm	Caloric load app. MJ / m	Max. transverse pressure N / cm	Weight kg / km	Part no.
A-DQ(ZN)B2Y	24	Single- and multimode G50/125	OM2 + ITU-T G.652	12	9,5	2500	200,0	2,50	400	90,0	803037
A-DQ(ZN)B2Y	24	Single- und Multimode G50/125 OM3	OM3 + ITU-T G.652	12	9,5	2500	200,0	2,50	400	90,0	803923
A-DQ(ZN)B2Y	48	Single- and multimode G50/125	OM2 + ITU-T G.652	12	9,5	2500	200,0	2,50	400	90,0	803038
A-DQ(ZN)B2Y	48	Single- und Multimode G50/125 OM3	OM3 + ITU-T G.652	12	9,5	2500	200,0	2,50	400	90,0	803924

Dimensions and specifications may be changed without prior notice.

Application

These HELUCOM[®] pact fibre-optic cables are characterized by a design that is particularly easy to mount, tension-resistant and rodent-proof. Around a stranded grooved cable and filler elements, there is a composite of glass yarns and swelling fleece with characteristics that ensure rodent protection, strain relief and waterproofing in longitudinal direction of the cable. In addition, these cables are designed grease-free. Wiping the jelly off is therefore unnecessary. This construction is particularly used in underground, tubes and channel areas, where packing density also plays a role.



Helutool HAP 6-20

Press tool APW 18

WK-Electro-hydraulic radial-piston-pump

Compression cable lug

HELU-S-PK-CU-DIN

WK-SC-T Shear Bolt Connector



■ ACCESSORIES & TOOLS

Designation	Page
Cable conduit and cable installation grips	254
Cable gland accessories – HELUTOP®	255
CU-Compression cable lugs	256
HELU-S-PK-CU-DIN	256
HELU-S-RK-CU	258
HELU-S-RK-CU-UL	259
HELU-S-RK-45-CU	261
HELU-S-RK-45-CU-UL	262
HELU-S-RK-90-CU-UL	264
AL-Compression cable lugs	265
HELU-S-PK-AL-DIN	265
HELU-S-PK-AL-FG	266
HELU-S-PK-AL-CU	267
KAC-U AL/CU washer	269
AL-Compression connectors	270
HELU-S-PV-AL-DIN	270
HELU-S-PV-AL-CU	271
HELU-S-PAB-AL-DIN	273
HELU-S-PAB-AL-CU-DIN	274
Screwdriving technology for the Powerline Series	275
WK-SC-P Bolt Connector	275
WK-SC-T Shear Bolt Connector	276
WK-SL-T Shear Bolt Cable Lug	277
Screwdriving technology for copper and aluminium Cl. 2	278
Bolt Cable Lug with Shear Head	278
Bolt Connector with Shear Head	279
Mechanical Split Connector with Shear Head	280
Cable fastening systems	281
HYDAC - Fastening Systems in the turret	281
Cable clamps	282
HELUWIND® WK-Multiclamp	283
The Roxtec Sealing Solution	284
Medium Voltage Cable Accessories	286
Cable Fittings from Tyco Electronics Raychem	286
IREV-S	288
FLEV-S	289
Repair Sleeves for shielded single-conductor plastic cable	290
Tyco Junctionbox MS	291
Insulating products	292
Heat-shrink tube SK-D 200	292
Rollover Insulation Hose	293
Tools	294
WK-APW 18	294
WK-Electro hydraulic pump with battery	295
WK-Electro-hydraulic radial-piston-pump (230V) with transport cart	296
Helutool HAP 6-20	297
Ready for China	298
Success through Quality and Innovation	300

Cable conduit and Cable grips

Cable conduit with inner striations

Suitable for plowing-in, laying in trenches, for blowing-in and pulling-in fiber optic cable, outside diameter 32 to 50 mm.



Cable installation grips with side loop

Properties:

- with thimble and press clamp
- self-tightening under tension load
- back-woven



Material:

galvanized stranded wire

Application

Employed as a cable installation grip. For anti-slip installation of vertically attached cables.

Cable installation grips with side loop, laterally displaced, open

Part no.	Min. interior diameter mm	Max. interior diameter mm	Length mm	Loadability in kN	Weight kg
905909	8	10	500	2,2	0,07
905601	10	15	500	3,4	0,08
905602	15	20	500	4,3	0,14
905603	20	25	500	6,8	0,16
905604	25	30	500	8,1	0,18
905597	30	40	500	11,7	0,4
905605	40	50	800	16,0	0,45
905606	50	60	800	16,0	0,6
905607	60	70	800	21,0	0,7
905918	70	90	800	21,0	0,9
905919	90	110	800	26,7	1,2

Dimensions and specifications may be changed without prior notice. Prices on request.

Cable grips with thimble and press clamp

Properties:

- with thimble and press clamp
- self-tightening under tension load
- back-woven



Material:

galvanized stranded wire

Application

This cable grip is used wherever cables with high tensile forces are routed.

Cable grips with thimble and press clamp, closed

Part no.	Min. interior diameter mm	Max. interior diameter mm	Length mm	Loadability in kN	Weight kg
905891	6	10	600	2,2	0,07
905892	10	15	600	3,4	0,08
905893	15	20	600	6,8	0,14
905375	20	25	600	6,8	0,15
905371	25	30	1000	8,1	0,18
905376	30	40	1250	11,7	0,4
905894	40	50	1250	16,0	0,45
905163	50	60	1500	16,0	0,6
905895	60	70	1500	21,3	0,7
905896	70	90	1500	27,9	0,9
905897	90	110	1500	34,9	1,5

Dimensions and specifications may be changed without prior notice. Prices on request.

Cable gland – HELUTOP®

HELUTOP® HT

The plastic cable gland with vibration protection.

Properties:

- Optimum strain relief through clamping plates
- Easy to assemble
- Large clamping areas



Technical Data:

Protection classification: IP 68 - 5 bar / IP69 K
Temperature range: -30°C up to +80°C
Testing standard: EN50262

Material:

• Halogen-free
• Silicone-free
• Cadmium-free
Shell: polyamide PA 6
Moulded seal: Neoprene

HELUTOP® HT-MS

The cable gland made of nickel-plated brass.

Properties:

- Optimum strain relief through clamping plates
- Easy to assemble
- Large clamping areas



Technical Data:

Protection classification: IP 68 - 5 bar / IP69 K
Temperature range: -40°C up to +100°C
Testing standard: EN50262

Material:

Shell: brass, nickel-plated
Terminal insert: polyamide PA 6
Moulded seal: Neoprene
O-ring: Buna-N

HELUTOP® MS-EP4

The new generation of EMC and earth glands with integrated contact system for reliable, quick assembly and contacting.

Properties:

- Optimum strain relief by means of clamping plates
- Large clamping areas
- Simple installation with open contact springs and rotating spring ring
- Reliable contact with high-quality copper-beryllium springs
- Highly vibration-resistant due to short distance from clamping to contact range
- Reliable EMC screening even in rugged applications



Technical Data:

Protection classification: IP68 – 5bar / IP69 K
Temperature range: -40°C bis +100°C
Testing standard: EN 50262

Material:

Shell: brass, nickel-plated
Contact spring: Copper-beryllium
Terminal insert: polyamide PA 6
Gasket: Neoprene
O-ring: NBR

HELUTOP® HT-E

The stainless steel cable gland for use in high-stress applications.

Properties:

- Optimum strain relief through clamping plates
- Highly corrosion-resistant
- Highly durable
- Easy to assemble
- Large clamping areas



Technical Data:

Protection classification: IP 68 - 5 bar / IP69 K
Temperature range: -40°C up to +100°C
Testing standard: EN50262

Material:

stainless steel 1.4305
Terminal insert: polyamide PA 6
Moulded seal: Neoprene
O-ring: Buna-N

HELU-S-PK-CU-DIN Tubular compression cable lugs - straight



Tubular compression lug HELU-S-PK-CU-DIN

Uninsulated tubular compression lugs in eye type design for conductor arrangement RM, to DIN 46235.

Material

Socket: Copper according to DIN EN 13600
Surface: tin plated or optionally uncoated

Note

Code type indicates the required hexagonal clamping insert.
Compression instruction and instruction for assembly see chapter "Technical information".

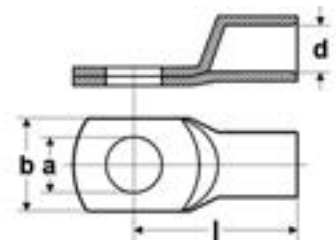

Diameter

- a Diameter of the boring
- d Inner diameter of the cable insertion
- b Flange width
- l Length till middle of the boring

eye type

Part no.	Type	Cross-section mm ²	a mm	d mm	b mm	l mm	Code type	Weight kg / 1000 items	Unit
907677	HELU-S-PK-CU-DIN 6-5	6,0	5,3	3,7	8,5	24,0	5	3,1	100
907678	HELU-S-PK-CU-DIN 6-6	6,0	6,4	3,7	3,7	24,0	5	3,4	100
907680	HELU-S-PK-CU-DIN 10-5	10,0	5,3	4,4	10,0	27,0	6	3,5	100
907681	HELU-S-PK-CU-DIN 10-6	10,0	6,4	4,4	10,0	27,0	6	3,7	100
907685	HELU-S-PK-CU-DIN 16-6	16,0	6,4	5,5	13,0	36,0	8	12,7	100
907686	HELU-S-PK-CU-DIN 16-8	16,0	8,4	5,5	13,0	37,0	8	13,0	100
907687	HELU-S-PK-CU-DIN 16-10	16,0	10,5	5,5	16,5	38,0	8	13,2	100
907689	HELU-S-PK-CU-DIN 25-6	25,0	6,4	7,0	14,0	39,0	10	16,2	100
907690	HELU-S-PK-CU-DIN 25-8	25,0	8,4	7,0	17,0	39,0	10	17,3	100
907691	HELU-S-PK-CU-DIN 25-10	25,0	10,5	7,0	17,0	40,5	10	17,7	100
907692	HELU-S-PK-CU-DIN 25-12	25,0	13,0	7,0	18,0	40,5	10	17,2	100
907695	HELU-S-PK-CU-DIN 35-8	35,0	8,4	8,2	18,0	42,0	12	31,9	100
907696	HELU-S-PK-CU-DIN 35-10	35,0	10,5	8,2	20,0	42,5	12	31,7	100
907697	HELU-S-PK-CU-DIN 35-12	35,0	13,0	8,2	21,0	44,0	12	31,1	100
907701	HELU-S-PK-CU-DIN 50-8	50,0	8,4	9,8	20,0	52,0	14	50,0	100
907702	HELU-S-PK-CU-DIN 50-10	50,0	10,5	9,8	22,0	52,0	14	49,4	100
907703	HELU-S-PK-CU-DIN 50-12	50,0	13,0	9,8	23,0	52,0	14	49,1	100
907705	HELU-S-PK-CU-DIN 50-16	50,0	17,0	9,8	28,0	55,5	14	50,4	100
907707	HELU-S-PK-CU-DIN 70-8	70,0	8,4	11,3	24,0	56,0	16	65,4	50
907708	HELU-S-PK-CU-DIN 70-10	70,0	10,5	11,3	24,0	56,0	16	65,4	50
907709	HELU-S-PK-CU-DIN 70-12	70,0	13,0	11,3	24,0	56,5	16	65,7	50
907711	HELU-S-PK-CU-DIN 70-16	70,0	17,0	11,3	29,0	57,0	16	69,2	50
906524	HELU-S-PK-CU-DIN 95-10	95,0	10,5	13,5	28,0	65,5	18	95,5	50
906525	HELU-S-PK-CU-DIN 95-12	95,0	13,0	13,5	28,0	65,5	18	94,5	50
907715	HELU-S-PK-CU-DIN 95-16	95,0	17,0	13,5	30,0	65,5	18	94,4	50
907716	HELU-S-PK-CU-DIN 95-20	95,0	21,0	13,5	33,0	71,0	18	98,6	50
906526	HELU-S-PK-CU-DIN 120-10	120,0	10,5	15,5	31,0	70,0	20	114,0	50
906527	HELU-S-PK-CU-DIN 120-12	120,0	13,0	15,5	31,0	70,5	20	114,3	50
907719	HELU-S-PK-CU-DIN 120-16	120,0	17,0	15,5	31,5	70,0	20	113,6	50
907720	HELU-S-PK-CU-DIN 120-20	120,0	21,0	15,5	36,0	72,0	20	115,1	50
907722	HELU-S-PK-CU-DIN 150-10	150,0	10,5	17,0	34,0	79,0	22	164,6	25
906528	HELU-S-PK-CU-DIN 150-12	150,0	13,0	17,0	34,0	78,5	22	165,3	25
906529	HELU-S-PK-CU-DIN 150-16	150,0	17,0	17,0	34,0	78,0	22	163,5	25
907724	HELU-S-PK-CU-DIN 150-20	150,0	21,0	17,0	38,0	78,0	22	163,4	25
907726	HELU-S-PK-CU-DIN 185-10	185,0	10,5	19,0	37,0	83,0	25	185,0	25
906530	HELU-S-PK-CU-DIN 185-12	185,0	13,0	19,0	37,0	82,5	25	189,5	25
906531	HELU-S-PK-CU-DIN 185-16	185,0	17,0	19,0	37,0	82,0	25	194,1	25

Continuation ▶

HELU-S-PK-CU-DIN Tubular compression cable lugs - straight

eye type

Part no.	Type	Cross-section mm ²	a mm	d mm	b mm	l mm	Code type	Weight kg / 1000 items	Unit	
907728	HELU-S-PK-CU-DIN 185-20	185,0	21,0	19,0	40,0	83,0	25	190,1	25	-
906532	HELU-S-PK-CU-DIN 240-12	240,0	13,0	21,5	42,5	92,0	28	266,5	20	-
906533	HELU-S-PK-CU-DIN 240-16	240,0	17,0	21,5	42,5	92,0	28	274,5	20	-
907731	HELU-S-PK-CU-DIN 240-20	240,0	21,0	21,5	45,0	92,0	28	276,7	20	-
906534	HELU-S-PK-CU-DIN 300-16	300,0	17,0	24,5	48,5	100,0	32	341,6	10	-
906535	HELU-S-PK-CU-DIN 300-20	300,0	21,0	24,5	48,5	100,0	32	344,6	10	-
906536	HELU-S-PK-CU-DIN 400-16	400,0	17,0	27,5	55,0	117,0	38	717,5	5	-
906537	HELU-S-PK-CU-DIN 400-20	400,0	21,0	27,5	55,0	117,0	38	706,4	5	-
906538	HELU-S-PK-CU-DIN 500-20	500,0	21,0	31,0	60,0	130,0	42	876,6	5	-
907744	HELU-S-PK-CU-DIN 625-20	625,0	21,0	34,5	63,0	135,0	44	820,5	5	-
907747	HELU-S-PK-CU-DIN 800-20	800,0	21,0	40,0	75,0	165,0	100	1455,5	2	-
907749	HELU-S-PK-CU-DIN 1000-20	1000,0	21,0	44,0	83,0	167,0	58	1890,0	2	-

Dimensions and specifications may be changed without prior notice.

HELU-S-RK-CU Copper tubular cable lug - straight

uninsulated



Tubular cable lug

HELU-S-RK-CU

Uninsulated, straight tubular cable lugs in eye type design.

Material

Socket: Copper according to DIN EN 13600
Surface: tin plated

Note

Also available in angulated version (45° and 90°).
Compression instruction and instruction for assembly see chapter "Technical information".

Technical data

Temperature range: up to +120°C

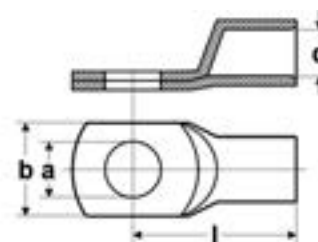

Abmessungen

- a Diameter of the boring
- d Inner diameter of the cable insertion
- b Flange width
- l Length till middle of the boring

eye type

Part no.	Type	Cross-section mm ²	a mm	d mm	b mm	l mm	Code type	Weight kg / 1000 items	Unit
907303	HELU-S-RK-CU 0,75-3	0,75	3,2	1,4	6,5	12,5	-	0,7	100
907304	HELU-S-RK-CU 0,75-4	0,75	4,3	1,4	8,5	14,0	-	0,8	100
907305	HELU-S-RK-CU 0,75-5	0,75	5,3	1,4	10,0	15,0	-	1,0	100
907306	HELU-S-RK-CU 1,5-3	1,5	3,2	1,9	6,5	14,0	-	1,2	100
907307	HELU-S-RK-CU 1,5-4	1,5	4,3	1,9	8,5	15,0	-	1,4	100
907308	HELU-S-RK-CU 1,5-5	1,5	5,3	1,9	10,0	16,0	-	1,5	100
907309	HELU-S-RK-CU 1,5-6	1,5	6,4	1,9	11,0	18,0	-	1,7	100
907310	HELU-S-RK-CU 2,5-4	2,5	4,3	2,4	8,5	15,0	-	1,6	100
907311	HELU-S-RK-CU 2,5-5	2,5	5,3	2,4	10,0	16,0	-	1,8	100
907312	HELU-S-RK-CU 2,5-6	2,5	6,4	2,4	11,0	18,0	-	1,9	100
907313	HELU-S-RK-CU 2,5-8	2,5	8,4	2,4	13,0	20,0	-	2,2	100
907314	HELU-S-RK-CU 4-4	4,0	4,3	3,0	8,5	17,0	-	2,2	100
907315	HELU-S-RK-CU 4-5	4,0	5,3	3,0	10,0	18,0	-	2,4	100
907316	HELU-S-RK-CU 4-6	4,0	6,3	3,0	11,0	20,0	-	2,6	100
907317	HELU-S-RK-CU 4-8	4,0	8,4	3,0	14,0	22,0	-	3,0	100

Dimensions and specifications may be changed without prior notice.

HELU-S-RK-CU-UL Tubular cable lug - straight



uninsulated



Tubular cable lug HELU-S-RK-CU-UL

Uninsulated, straight tubular cable lugs in eye type design.

Material

Socket: Copper according to DIN EN 13600
Surface: tin plated

Technical data

Temperature range: up to +120°C

Note

Also available in angulated version (45° and 90°).

Compression instruction and instruction for assembly see chapter "Technical information".

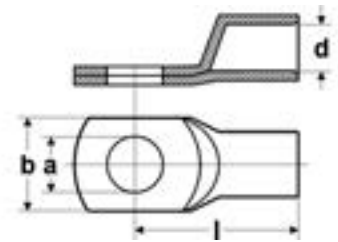

Abmessungen

- a Diameter of the boring
- d Inner diameter of the cable insertion
- b Flange width
- l Length till middle of the boring

eye type

Part no.	Type	Cross-section mm ²	a mm	d mm	b mm	l mm	Code type	Weight kg / 1000 items	Unit
907318	HELU-S-RK-CU-UL 6-4	6,0	4,3	3,5	10,0	19,0	-	4,6	100
907319	HELU-S-RK-CU-UL 6-5	6,0	5,3	3,5	10,0	20,0	-	4,7	100
907320	HELU-S-RK-CU-UL 6-6	6,0	6,4	3,5	11,0	21,5	-	5,4	100
907321	HELU-S-RK-CU-UL 6-8	6,0	8,4	3,5	15,0	24,0	-	5,9	100
907322	HELU-S-RK-CU-UL 6-10	6,0	10,5	3,5	18,0	26,0	-	6,4	100
907323	HELU-S-RK-CU-UL 6-12	6,0	13,0	3,5	19,0	27,5	-	6,4	100
907324	HELU-S-RK-CU-UL 10-4	10,0	4,3	4,5	12,0	20,0	-	4,3	100
907325	HELU-S-RK-CU-UL 10-5	10,0	5,3	4,5	12,0	21,0	-	4,8	100
907326	HELU-S-RK-CU-UL 10-6	10,0	6,4	4,5	12,0	22,5	-	5,1	100
907327	HELU-S-RK-CU-UL 10-8	10,0	8,4	4,5	15,0	25,0	-	5,8	100
907328	HELU-S-RK-CU-UL 10-10	10,0	10,5	4,4	18,0	27,0	-	6,3	100
907329	HELU-S-RK-CU-UL 10-12	10,0	13,0	4,5	20,0	28,5	-	6,3	100
907330	HELU-S-RK-CU-UL 16-4	16,0	4,3	5,5	12,0	24,0	-	8,2	100
907331	HELU-S-RK-CU-UL 16-5	16,0	5,3	5,5	12,0	25,0	-	8,9	100
907332	HELU-S-RK-CU-UL 16-6	16,0	6,4	5,5	12,0	26,5	-	9,6	100
907333	HELU-S-RK-CU-UL 16-8	16,0	8,4	5,5	15,0	29,0	-	10,3	100
907334	HELU-S-RK-CU-UL 16-10	16,0	10,5	5,5	18,0	31,0	-	11,0	100
907335	HELU-S-RK-CU-UL 16-12	16,0	13,0	5,5	19,0	32,0	-	10,8	100
907336	HELU-S-RK-CU-UL 25-5	25,0	5,3	7,0	15,0	33,5	-	13,5	100
907337	HELU-S-RK-CU-UL 25-6	25,0	6,4	7,0	15,0	31,5	-	13,1	100
907338	HELU-S-RK-CU-UL 25-8	25,0	8,4	7,0	16,0	33,0	-	12,9	100
907339	HELU-S-RK-CU-UL 25-10	25,0	10,5	7,0	18,0	34,5	-	14,6	100
907340	HELU-S-RK-CU-UL 25-12	25,0	13,0	7,0	20,0	36,0	-	15,5	100
907341	HELU-S-RK-CU-UL 25-14	25,0	15,0	7,0	22,0	39,0	-	16,6	100
907342	HELU-S-RK-CU-UL 25-16	25,0	17,0	7,0	24,0	42,0	-	17,3	100
907343	HELU-S-RK-CU-UL 35-6	35,0	6,4	8,5	17,0	33,0	-	20,7	100
907344	HELU-S-RK-CU-UL 35-8	35,0	8,4	8,5	17,0	34,0	-	21,8	100
907345	HELU-S-RK-CU-UL 35-10	35,0	10,5	8,5	20,0	36,5	-	21,9	100
907346	HELU-S-RK-CU-UL 35-12	35,0	13,0	8,5	22,0	37,5	-	23,3	100
907347	HELU-S-RK-CU-UL 35-14	35,0	15,0	8,5	23,0	40,0	-	24,4	100

Continuation ▶

HELU-S-RK-CU-UL Tubular cable lug - straight



uninsulated

eye type

Part no.	Type	Cross-section mm ²	a mm	d mm	b mm	l mm	Code type	Weight kg / 1000 items	Unit	
907348	HELU-S-RK-CU-UL 35-16	35,0	17,0	8,5	28,0	44,0	-	26,0	100	-
907349	HELU-S-RK-CU-UL 50-6	50,0	6,4	10,0	20,0	37,0	-	30,1	100	-
907350	HELU-S-RK-CU-UL 50-8	50,0	8,4	10,0	20,0	39,0	-	30,4	100	-
907351	HELU-S-RK-CU-UL 50-10	50,0	10,5	10,0	20,0	40,5	-	31,3	100	-
907352	HELU-S-RK-CU-UL 50-12	50,0	13,0	10,0	23,0	42,0	-	31,3	100	-
907353	HELU-S-RK-CU-UL 50-14	50,0	15,0	10,0	23,0	44,0	-	35,1	100	-
907354	HELU-S-RK-CU-UL 50-16	50,0	17,0	10,0	27,0	46,0	-	35,5	100	-
907355	HELU-S-RK-CU-UL 50-20	50,0	21,0	10,0	30,5	52,5	-	38,9	100	-
907356	HELU-S-RK-CU-UL 70-6	70,0	6,4	12,0	24,0	40,5	-	41,1	25	-
907357	HELU-S-RK-CU-UL 70-8	70,0	8,4	12,0	24,0	42,5	-	44,6	25	-
907358	HELU-S-RK-CU-UL 70-10	70,0	10,5	12,0	24,0	43,5	-	46,4	25	-
907359	HELU-S-RK-CU-UL 70-12	70,0	13,0	12,0	24,0	45,0	-	47,3	25	-
907360	HELU-S-RK-CU-UL 70-14	70,0	15,0	12,0	25,0	46,0	-	49,1	25	-
907361	HELU-S-RK-CU-UL 70-16	70,0	17,0	12,0	28,0	48,5	-	49,6	25	-
907362	HELU-S-RK-CU-UL 70-20	70,0	21,0	12,0	29,0	52,0	-	52,9	25	-
907363	HELU-S-RK-CU-UL 95-6	95,0	6,4	13,5	26,0	43,0	-	49,5	25	-
907364	HELU-S-RK-CU-UL 95-8	95,0	8,4	13,5	26,0	46,0	-	53,6	25	-
907365	HELU-S-RK-CU-UL 95-10	95,0	10,5	13,5	26,0	47,0	-	55,1	25	-
907366	HELU-S-RK-CU-UL 95-12	95,0	13,0	13,5	26,0	48,0	-	55,1	25	-
907367	HELU-S-RK-CU-UL 95-14	95,0	15,0	13,5	26,0	51,5	-	58,9	25	-
907368	HELU-S-RK-CU-UL 95-16	95,0	17,0	13,5	28,0	51,0	-	58,5	25	-
907369	HELU-S-RK-CU-UL 95-20	95,0	21,0	13,5	30,0	55,0	-	61,3	25	-
907370	HELU-S-RK-CU-UL 120-8	120,0	8,4	15,0	29,0	49,5	-	68,8	25	-
907371	HELU-S-RK-CU-UL 120-10	120,0	10,5	15,0	29,0	52,0	-	79,9	25	-
907372	HELU-S-RK-CU-UL 120-12	120,0	13,0	15,0	29,0	51,5	-	78,4	25	-
907373	HELU-S-RK-CU-UL 120-14	120,0	15,0	15,0	30,0	53,0	-	78,6	25	-
907374	HELU-S-RK-CU-UL 120-16	120,0	17,0	15,0	30,0	55,0	-	80,7	25	-
907375	HELU-S-RK-CU-UL 120-20	120,0	21,0	15,0	35,0	60,0	-	89,0	25	-
907376	HELU-S-RK-CU-UL 150-8	150,0	8,4	16,8	31,0	55,5	-	78,9	25	-
907377	HELU-S-RK-CU-UL 150-10	150,0	10,5	16,8	31,0	56,5	-	83,7	25	-
907378	HELU-S-RK-CU-UL 150-12	150,0	13,0	16,8	31,0	56,0	-	80,7	25	-
907379	HELU-S-RK-CU-UL 150-14	150,0	15,0	16,8	31,0	57,0	-	83,0	25	-
907380	HELU-S-RK-CU-UL 150-16	150,0	17,0	16,8	31,0	58,0	-	83,6	25	-
907381	HELU-S-RK-CU-UL 150-20	150,0	21,0	16,8	35,0	63,0	-	87,5	25	-
907382	HELU-S-RK-CU-UL 185-8	185,0	8,4	19,0	35,0	58,0	-	103,7	25	-
907383	HELU-S-RK-CU-UL 185-10	185,0	10,5	19,0	35,0	59,0	-	106,1	25	-
907384	HELU-S-RK-CU-UL 185-12	185,0	13,0	19,0	35,0	58,5	-	106,0	25	-
907385	HELU-S-RK-CU-UL 185-14	185,0	15,0	19,0	35,0	61,0	-	107,2	25	-
907386	HELU-S-RK-CU-UL 185-16	185,0	17,0	19,0	35,0	63,0	-	108,6	25	-
907387	HELU-S-RK-CU-UL 185-20	185,0	21,0	19,0	35,0	66,0	-	113,3	25	-
907388	HELU-S-RK-CU-UL 240-8	240,0	8,4	21,0	38,0	67,0	-	124,0	25	-
907389	HELU-S-RK-CU-UL 240-10	240,0	10,5	21,0	38,0	67,0	-	129,7	25	-
907390	HELU-S-RK-CU-UL 240-12	240,0	13,0	21,0	38,0	67,0	-	130,2	25	-
907391	HELU-S-RK-CU-UL 240-14	240,0	15,0	21,0	38,0	69,0	-	133,6	25	-
907392	HELU-S-RK-CU-UL 240-16	240,0	17,0	21,0	38,0	69,5	-	135,6	20	-
907393	HELU-S-RK-CU-UL 240-20	240,0	21,0	21,0	38,0	71,0	-	138,0	25	-
907394	HELU-S-RK-CU-UL 300-10	300,0	10,5	24,0	44,0	79,5	-	204,5	20	-
907395	HELU-S-RK-CU-UL 300-12	300,0	13,0	24,0	44,0	82,0	-	211,8	20	-
907396	HELU-S-RK-CU-UL 300-14	300,0	15,0	24,0	44,0	84,0	-	221,9	20	-
907397	HELU-S-RK-CU-UL 300-16	300,0	17,0	24,0	44,0	85,0	-	219,4	20	-
907398	HELU-S-RK-CU-UL 300-20	300,0	21,0	24,0	44,0	85,0	-	224,0	20	-
907399	HELU-S-RK-CU-UL 400-10	400,0	10,5	27,5	49,0	92,0	-	279,0	15	-
907400	HELU-S-RK-CU-UL 400-12	400,0	13,0	27,5	49,0	92,0	-	278,5	15	-
907401	HELU-S-RK-CU-UL 400-16	400,0	17,0	27,5	49,0	92,0	-	276,5	15	-
907402	HELU-S-RK-CU-UL 400-20	400,0	21,0	27,5	49,0	92,0	-	266,1	15	-
907403	HELU-S-RK-CU-UL 500-12	500,0	13,0	31,0	55,5	113,0	-	493,8	5	-
907404	HELU-S-RK-CU-UL 500-16	500,0	17,0	31,0	55,5	113,0	-	493,8	5	-
907405	HELU-S-RK-CU-UL 500-20	500,0	21,0	31,0	55,5	113,0	-	485,6	5	-
907406	HELU-S-RK-CU-UL 630-16	630,0	17,0	34,0	60,0	115,0	-	513,5	5	-
907407	HELU-S-RK-CU-UL 630-20	630,0	21,0	34,0	60,0	115,0	-	506,0	5	-

Dimensions and specifications may be changed without prior notice.

HELU-S-RK-45-CU Copper tubular cable lug - 45° angled



Tubular cable lug angled HELU-S-RK-45-CU

Non-insulated tubular cable lugs in eye type design, 45° angled.

Material

Socket: Copper according to DIN EN 13600
Surface: tin plated

Note

Compression instruction and instruction for assembly see chapter "Technical information".

Technical data

Temperature range: up to +120°C

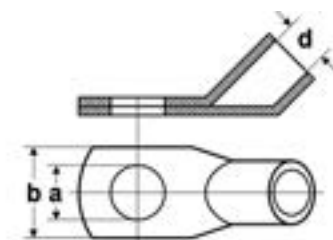

Dimensions

- a Diameter of the boring
- d Inner diameter of the cable insertion
- b Flange width

eye type

Part no. 45°	Type	Cross-section mm ²	a mm	d mm	b mm	Weight kg / 1000 items	Unit
907600	HELU-S-RK-45-CU 10-10	10,0	10,5	4,5	18,0	6,6	100
907478	HELU-S-RK-45-CU 50-6	50,0	6,4	10,0	20,0	29,4	50
907488	HELU-S-RK-45-CU 95-16	95,0	17,0	13,5	28,0	68,0	25
907493	HELU-S-RK-45-CU 150-8	150,0	8,4	16,8	31,0	113,1	25
907497	HELU-S-RK-45-CU 150-20	150,0	21,0	16,8	35,0	101,2	25
907505	HELU-S-RK-45-CU 300-12	300,0	13,0	24,0	43,0	257,0	15
907506	HELU-S-RK-45-CU 300-16	300,0	17,0	24,0	43,0	256,8	15
907507	HELU-S-RK-45-CU 300-20	300,0	21,0	24,0	43,0	273,0	15

Dimensions and specifications may be changed without prior notice.

HELU-S-RK-45-CU-UL Copper tubular cable lug - 45° angled



Tubular cable lug angled

HELU-S-RK-45-CU-UL

Non-insulated tubular cable lugs in eye type design, 45° angled.

Material

Socket: Copper according to DIN EN 13600
Surface: tin plated

Technical data

Temperature range: up to +120°C

Note

Compression instruction and instruction for assembly see chapter "Technical information".

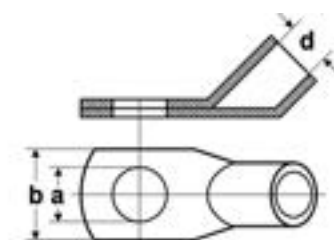

Dimensions

- a Diameter of the boring
- d Inner diameter of the cable insertion
- b Flange width

eye type

Part no. 45°	Type	Cross-section mm ²	a mm	d mm	b mm	Weight kg / 1000 items	Unit
907597	HELU-S-RK-45-CU-UL 10-5	10,0	5,3	4,5	12,0	5,5	100
907598	HELU-S-RK-45-CU-UL 10-6	10,0	6,4	4,5	12,0	5,8	100
907599	HELU-S-RK-45-CU-UL 10-8	10,0	8,4	4,5	15,0	6,5	100
907601	HELU-S-RK-45-CU-UL 16-5	16,0	5,3	5,5	12,0	9,5	100
907467	HELU-S-RK-45-CU-UL 16-6	16,0	6,4	5,5	12,0	10,2	100
907468	HELU-S-RK-45-CU-UL 16-8	16,0	8,4	5,5	15,0	11,7	100
907469	HELU-S-RK-45-CU-UL 16-10	16,0	10,5	5,5	18,0	11,7	100
907470	HELU-S-RK-45-CU-UL 25-6	25,0	6,4	7,0	15,0	13,9	100
907471	HELU-S-RK-45-CU-UL 25-8	25,0	8,4	7,0	16,0	15,1	100
907472	HELU-S-RK-45-CU-UL 25-10	25,0	10,5	7,0	18,0	16,6	100
907473	HELU-S-RK-45-CU-UL 25-12	25,0	13,0	7,0	20,0	17,0	100
907474	HELU-S-RK-45-CU-UL 35-6	35,0	6,4	8,5	17,0	21,7	50
907475	HELU-S-RK-45-CU-UL 35-8	35,0	8,4	8,5	17,0	22,3	50
907476	HELU-S-RK-45-CU-UL 35-10	35,0	10,5	8,5	20,0	23,4	50
907477	HELU-S-RK-45-CU-UL 35-12	35,0	13,0	8,5	22,0	24,0	50
907479	HELU-S-RK-45-CU-UL 50-8	50,0	8,4	10,0	20,0	33,4	50
907480	HELU-S-RK-45-CU-UL 50-10	50,0	10,5	10,0	20,0	36,5	50
907481	HELU-S-RK-45-CU-UL 50-12	50,0	13,0	10,0	23,0	36,5	50
907482	HELU-S-RK-45-CU-UL 70-8	70,0	8,4	12,0	24,0	49,0	25
907483	HELU-S-RK-45-CU-UL 70-10	70,0	10,5	12,0	24,0	52,3	25
907484	HELU-S-RK-45-CU-UL 70-12	70,0	13,0	12,0	24,0	53,4	25
907485	HELU-S-RK-45-CU-UL 95-8	95,0	8,4	13,5	26,0	61,8	25
907486	HELU-S-RK-45-CU-UL 95-10	95,0	10,5	13,5	26,0	62,0	25
907487	HELU-S-RK-45-CU-UL 95-12	95,0	13,0	13,5	26,0	62,0	25
907489	HELU-S-RK-45-CU-UL 120-8	120,0	8,4	15,0	29,0	78,0	25
907490	HELU-S-RK-45-CU-UL 120-10	120,0	10,5	15,0	29,0	89,0	25
907491	HELU-S-RK-45-CU-UL 120-12	120,0	13,0	15,0	29,0	89,1	25
907492	HELU-S-RK-45-CU-UL 120-16	120,0	17,0	15,0	30,0	93,1	25
907494	HELU-S-RK-45-CU-UL 150-10	150,0	10,5	16,8	31,0	98,0	25
907495	HELU-S-RK-45-CU-UL 150-12	150,0	13,0	16,8	31,0	96,8	25
907496	HELU-S-RK-45-CU-UL 150-16	150,0	17,0	16,8	31,0	101,2	25
907498	HELU-S-RK-45-CU-UL 185-10	185,0	10,5	19,0	35,0	123,5	20
907499	HELU-S-RK-45-CU-UL 185-12	185,0	13,0	19,0	35,0	122,4	20
907500	HELU-S-RK-45-CU-UL 185-16	185,0	17,0	19,0	35,0	128,4	20
907501	HELU-S-RK-45-CU-UL 185-20	185,0	21,0	19,0	35,0	139,9	20
907502	HELU-S-RK-45-CU-UL 240-12	240,0	13,0	21,0	38,0	154,6	15
907503	HELU-S-RK-45-CU-UL 240-16	240,0	17,0	21,0	38,0	165,1	15
907504	HELU-S-RK-45-CU-UL 240-20	240,0	21,0	21,0	38,0	170,4	15

Dimensions and specifications may be changed without prior notice.

HELU-S-RK-90-CU-UL Copper tubular cable lug - 90° angled



Tubular cable lug angled HELU-S-RK-90-CU-UL

Non-insulated tubular cable lugs in eye type design, 90° angled.

Material

Socket: Copper according to DIN EN 13600
Surface: tin plated

Technical data

Temperature range: up to +120°C

Note

Compression instruction and instruction for assembly see chapter "Technical information".

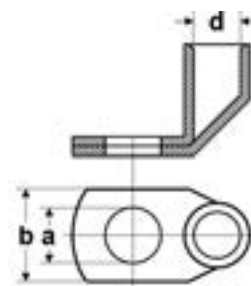

Dimensions

- a Diameter of boring
- d Inner diameter of the cable insertion
- b Flange width

eye type

Part no. 90°	Type	Cross-section mm ²	a mm	d mm	b mm	Weight kg / 1000 items	Unit	
907508	HELU-S-RK-90-CU-UL 6-5	6,0	5,3	3,5	11,0	5,6	100	-
907509	HELU-S-RK-90-CU-UL 6-6	6,0	6,4	3,5	11,0	6,2	100	-
907510	HELU-S-RK-90-CU-UL 6-8	6,0	8,4	3,5	15,0	6,4	100	-
907511	HELU-S-RK-90-CU-UL 6-10	6,0	10,5	3,5	18,0	6,8	100	-
907512	HELU-S-RK-90-CU-UL 6-12	6,0	13,0	3,5	20,0	6,6	100	-
907513	HELU-S-RK-90-CU-UL 10-5	10,0	5,3	4,5	12,0	5,4	100	-
907514	HELU-S-RK-90-CU-UL 10-6	10,0	6,4	4,5	12,0	5,9	100	-
907515	HELU-S-RK-90-CU-UL 10-8	10,0	8,4	4,5	15,0	6,7	100	-
907516	HELU-S-RK-90-CU-UL 10-10	10,0	10,5	4,5	18,0	7,0	100	-
907517	HELU-S-RK-90-CU-UL 10-12	10,0	13,0	4,5	20,0	7,0	100	-
907518	HELU-S-RK-90-CU-UL 16-5	16,0	5,3	5,5	12,0	10,7	100	-
907519	HELU-S-RK-90-CU-UL 16-6	16,0	6,4	5,5	12,0	11,5	100	-
907520	HELU-S-RK-90-CU-UL 16-8	16,0	8,4	5,5	15,0	12,0	100	-
907521	HELU-S-RK-90-CU-UL 16-10	16,0	10,5	5,5	18,0	12,3	100	-
907522	HELU-S-RK-90-CU-UL 16-12	16,0	13,0	5,5	20,0	12,3	100	-
907523	HELU-S-RK-90-CU-UL 25-6	25,0	6,4	7,0	15,0	13,5	100	-
907524	HELU-S-RK-90-CU-UL 25-8	25,0	8,4	7,0	16,0	14,3	100	-
907525	HELU-S-RK-90-CU-UL 25-10	25,0	10,5	7,0	18,0	15,7	100	-
907526	HELU-S-RK-90-CU-UL 25-12	25,0	13,0	7,0	20,0	15,1	100	-
907527	HELU-S-RK-90-CU-UL 35-6	35,0	6,4	8,5	17,0	21,0	100	-
907528	HELU-S-RK-90-CU-UL 35-8	35,0	8,4	8,5	17,0	23,1	100	-
907529	HELU-S-RK-90-CU-UL 35-10	35,0	10,5	8,5	20,0	23,6	100	-
907530	HELU-S-RK-90-CU-UL 35-12	35,0	13,0	8,5	22,0	23,7	100	-
907531	HELU-S-RK-90-CU-UL 35-16	35,0	17,0	8,5	28,0	24,8	100	-
907532	HELU-S-RK-90-CU-UL 50-6	50,0	6,4	10,0	20,0	30,0	100	-
907533	HELU-S-RK-90-CU-UL 50-8	50,0	8,4	10,0	20,0	32,2	100	-
907534	HELU-S-RK-90-CU-UL 50-10	50,0	10,5	10,0	20,0	33,2	100	-
907535	HELU-S-RK-90-CU-UL 50-12	50,0	13,0	10,0	23,0	32,8	100	-
907536	HELU-S-RK-90-CU-UL 50-16	50,0	17,0	10,0	27,0	36,3	100	-
907537	HELU-S-RK-90-CU-UL 50-20	50,0	21,0	10,0	30,0	38,9	100	-
907538	HELU-S-RK-90-CU-UL 70-6	70,0	6,4	12,0	24,0	44,1	25	-
907539	HELU-S-RK-90-CU-UL 70-8	70,0	8,4	12,0	24,0	48,6	25	-
907540	HELU-S-RK-90-CU-UL 70-10	70,0	10,5	12,0	24,0	50,6	25	-
907541	HELU-S-RK-90-CU-UL 70-12	70,0	13,0	12,0	24,0	49,4	25	-
907542	HELU-S-RK-90-CU-UL 70-16	70,0	17,0	12,0	28,0	51,1	25	-
907543	HELU-S-RK-90-CU-UL 70-20	70,0	21,0	12,0	29,0	52,6	25	-

Continuation ▶

HELU-S-RK-90-CU-UL Copper tubular cable lug - 90° angled



eye type

Part no. 90°	Type	Cross-section mm ²	a mm	d mm	b mm	Weight kg / 1000 items	Unit	
907544	HELU-S-RK-90-CU-UL 95-8	95,0	8,4	13,5	26,0	53,3	25	-
907545	HELU-S-RK-90-CU-UL 95-10	95,0	10,5	13,5	26,0	55,9	25	-
907546	HELU-S-RK-90-CU-UL 95-12	95,0	13,0	13,5	26,0	56,6	25	-
907547	HELU-S-RK-90-CU-UL 95-16	95,0	17,0	13,5	28,0	60,0	25	-
907548	HELU-S-RK-90-CU-UL 120-8	120,0	8,4	15,0	29,0	76,3	25	-
907549	HELU-S-RK-90-CU-UL 120-10	120,0	10,5	15,0	29,0	80,7	25	-
907550	HELU-S-RK-90-CU-UL 120-12	120,0	13,0	15,0	29,0	79,9	25	-
907551	HELU-S-RK-90-CU-UL 120-16	120,0	17,0	15,0	30,0	84,6	25	-
907552	HELU-S-RK-90-CU-UL 150-8	150,0	8,4	16,8	31,0	80,3	25	-
907553	HELU-S-RK-90-CU-UL 150-10	150,0	10,5	16,8	31,0	80,7	25	-
907554	HELU-S-RK-90-CU-UL 150-12	150,0	13,0	16,8	31,0	82,9	25	-
907555	HELU-S-RK-90-CU-UL 150-16	150,0	17,0	16,8	31,0	85,0	25	-
907556	HELU-S-RK-90-CU-UL 150-20	150,0	21,0	16,8	35,0	88,9	25	-
907557	HELU-S-RK-90-CU-UL 185-10	185,0	10,5	19,0	35,0	114,1	25	-
907558	HELU-S-RK-90-CU-UL 185-12	185,0	13,0	19,0	35,0	120,4	25	-
907559	HELU-S-RK-90-CU-UL 185-16	185,0	17,0	19,0	35,0	124,8	25	-
907560	HELU-S-RK-90-CU-UL 185-20	185,0	21,0	19,0	35,0	127,0	25	-
907561	HELU-S-RK-90-CU-UL 240-10	240,0	10,5	21,0	38,0	133,2	25	-
907562	HELU-S-RK-90-CU-UL 240-12	240,0	13,0	21,0	38,0	134,0	25	-
907563	HELU-S-RK-90-CU-UL 240-16	240,0	17,0	21,0	38,0	137,6	25	-
907564	HELU-S-RK-90-CU-UL 240-20	240,0	21,0	21,0	38,0	142,3	25	-
907565	HELU-S-RK-90-CU-UL 300-12	300,0	13,0	24,0	43,0	199,2	20	-
907566	HELU-S-RK-90-CU-UL 300-16	300,0	17,0	24,0	43,0	209,0	20	-
907567	HELU-S-RK-90-CU-UL 300-20	300,0	21,0	24,0	43,0	218,1	20	-

Dimensions and specifications may be changed without prior notice.

HELU-S-PK-AL-DIN Tubular compression cable lugs

uninsulated



Compression cable lug HELU-S-PK-AL-DIN

Uninsulated, straight tubular cable lug in eye type design made of aluminium. High quality version for reliable crimping. Designed for conductor type RM acc. to DIN 48201 and circular reshaped conductors.

Material

AL 99,5
Surface: bare

Note

Code type indicates the required hexagonal crimping insert.
Sleeves are prefilled with contact grease and sealed with plastic plug
Compression instruction and instruction for assembly see chapter "Technical information".

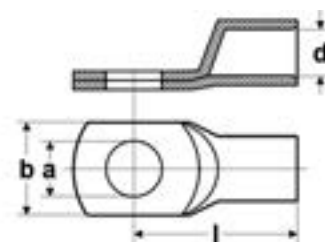

Dimensions

a Diameter of the bore
d Inner diameter of the cable inclusion
b Flange width
l Length to middle of the bore

eye type

Part no.	Type	Cross-section RM/SM - SE mm ²	a mm	d mm	b mm	l mm	Code type	Weight kg / 1000 items	Unit
907865	HELU-S-PK-AL-DIN 16-8	16,0 - 25,0	8,4	5,6	16,0	52,0	12	9,6	50
907866	HELU-S-PK-AL-DIN 16-10	16,0 - 25,0	10,5	5,6	18,0	52,0	12	9,7	50
907867	HELU-S-PK-AL-DIN 25-8	25,0 - 35,0	8,4	6,8	16,0	60,0	12	14,8	50
907868	HELU-S-PK-AL-DIN 25-10	25,0 - 35,0	10,5	6,8	18,0	60,0	12	15,3	50
907869	HELU-S-PK-AL-DIN 35-8	35,0 - 50,0	8,4	8,0	20,0	67,0	14	24,5	50
907870	HELU-S-PK-AL-DIN 35-10	35,0 - 50,0	10,5	8,0	20,0	67,0	14	24,5	50
907871	HELU-S-PK-AL-DIN 35-12	35,0 - 50,0	13,0	8,0	20,0	67,0	14	23,5	50
907872	HELU-S-PK-AL-DIN 50-8	50,0 - 70,0	8,4	10,0	23,0	74,0	16	32,9	25
907873	HELU-S-PK-AL-DIN 50-10	50,0 - 70,0	10,5	10,0	23,0	74,0	16	28,8	25
907874	HELU-S-PK-AL-DIN 50-12	50,0 - 70,0	13,0	10,0	23,0	74,0	16	33,8	25
907875	HELU-S-PK-AL-DIN 70-10	70,0 - 95,0	10,5	11,5	28,0	84,0	18	47,7	25
907876	HELU-S-PK-AL-DIN 70-12	70,0 - 95,0	13,0	11,5	28,0	87,0	18	47,3	25
907877	HELU-S-PK-AL-DIN 95-10	95,0 - 120,0	10,5	13,2	32,0	90,0	22	70,1	10
907878	HELU-S-PK-AL-DIN 95-12	95,0 - 120,0	13,0	13,2	32,0	90,0	22	78,2	10
907879	HELU-S-PK-AL-DIN 95-16	95,0 - 120,0	17,0	13,2	32,0	90,0	22	76,2	10
907880	HELU-S-PK-AL-DIN 120-10	120,0 - 150,0	10,5	14,7	32,0	98,0	22	83,8	10
907881	HELU-S-PK-AL-DIN 120-12	120,0 - 150,0	13,0	14,7	32,0	98,0	22	87,9	10
907882	HELU-S-PK-AL-DIN 120-16	120,0 - 150,0	17,0	14,7	32,0	98,0	22	86,4	10
906459	HELU-S-PK-AL-DIN 150-10	150,0 - 185,0	10,5	16,3	35,0	104,0	25	99,8	10
906436	HELU-S-PK-AL-DIN 150-12	150,0 - 185,0	13,0	16,3	35,0	104,0	25	102,3	10
906461	HELU-S-PK-AL-DIN 150-16	150,0 - 185,0	17,0	16,3	35,0	104,0	25	100,8	10
906462	HELU-S-PK-AL-DIN 150-20	150,0 - 185,0	21,0	16,3	35,0	104,0	25	100,2	10
907883	HELU-S-PK-AL-DIN 185-10	185,0 - 240,0	10,5	18,5	40,0	109,0	28	133,9	10
906463	HELU-S-PK-AL-DIN 185-12	185,0 - 240,0	13,0	18,5	40,0	109,0	28	133,9	10
906464	HELU-S-PK-AL-DIN 185-16	185,0 - 240,0	17,0	18,5	40,0	109,0	28	137,5	10
906465	HELU-S-PK-AL-DIN 185-20	185,0 - 240,0	21,0	18,5	40,0	109,0	28	137,5	10
907884	HELU-S-PK-AL-DIN 240-10	240,0 - 300,0	10,5	21,0	46,0	119,0	32	182,8	10
906466	HELU-S-PK-AL-DIN 240-12	240,0 - 300,0	13,0	21,0	46,0	119,0	32	179,4	10
906467	HELU-S-PK-AL-DIN 240-16	240,0 - 300,0	17,0	21,0	46,0	119,0	32	176,2	10
906468	HELU-S-PK-AL-DIN 240-20	240,0 - 300,0	21,0	21,0	46,0	119,0	32	179,0	10
906469	HELU-S-PK-AL-DIN 300-12	300,0	13,0	23,3	50,0	125,0	34	205,4	5
906470	HELU-S-PK-AL-DIN 300-16	300,0	17,0	23,3	50,0	125,0	34	201,4	5
906471	HELU-S-PK-AL-DIN 300-20	300,0	21,0	23,3	50,0	125,0	34	194,3	5
906472	HELU-S-PK-AL-DIN 400-12	400,0	13,0	26,0	55,0	120,0	38	283,0	5
906473	HELU-S-PK-AL-DIN 400-16	400,0	17,0	26,0	55,0	120,0	38	273,3	5
906474	HELU-S-PK-AL-DIN 400-20	400,0	21,0	26,0	55,0	120,0	38	240,0	5
906475	HELU-S-PK-AL-DIN 500-12	500,0	13,0	29,0	63,0	140,0	44	380,0	5
906476	HELU-S-PK-AL-DIN 500-16	500,0	17,0	29,0	63,0	140,0	44	378,0	5
906477	HELU-S-PK-AL-DIN 500-20	500,0	21,0	29,0	63,0	140,0	44	373,5	5

Dimensions and specifications may be changed without prior notice.

HELU-S-PK-AL-FG compression cable lug, FG, extruded, straight ring design



Technical Data

Material: Aluminium AL 99,5
Surface: bright or tinned
Special feature: smaller connecting flange (b) than DIN compression cable lugs

Note

- Sleeve filled with contact lubricant and closed against drying out
- Strain-relieved for aluminum conductors
- DIN 46329

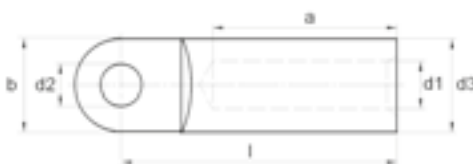

HELU-S-PK-AL-FG

Part No. bright	Part No. tinned	Cross section mm ² rm/sm*	Hole M	Key Figures	Dimensions in mm					
					d1	d3	d2	b	l	a
909835	909853	16*	8	12	5,8		8,4	20	53	30
909836	909854	16	10	12	5,8		10,5	20	53	30
909837	909855	25	8	12	6,8		8,4	25	53	30
909838	909856	25	10	12	6,8		10,5	25	53	30
909839	909857	25	12	12	6,8		13	25	53	30
909840	909858	35	8	14	8		8,4	25	65	42
909841	909859	35	10	14	8		10,5	25	65	42
909842	909860	35	12	14	8		13	25	65	42
909843	909861	50	8	16	9,8		8,4	25	65	42
909844	909862	50	10	16	9,8		10,5	25	65	42
909845	909863	50	12	16	9,8		13	25	65	42
909846	909864	70	8	18	11,2		8,4	25	75	52
909847	909865	70	10	18	11,2		10,5	25	75	52
909848	909866	70	12	18	11,2		13	25	75	52
909849	909867	95	8	22	13,2	22	8,4	25	81	56
906539	906562	95	10	22	13,2	22	10,5	25	81	56
906540	906563	95	12	22	13,2	22	13	25	81	56
906541	906564	120	10	22	14,7	23	10,5	30	86	56
906542	906565	120	12	22	14,7	23	13	30	86	56
906543	906566	120	16	22	14,7	23	17	30	86	56
906544	906567	150	10	25	16,3	25	10,5	30	90	60
906545	906568	150	12	25	16,3	25	13	30	90	60
906546	906569	150	16	25	16,3	25	17	30	90	60
909850	909868	150	20	25	16,3	25	21	25	90	60
906547	906570	185	10	28	18,3	28,5	10,5	30	91	60
906548	906571	185	12	28	18,3	28,5	13	30	91	60
906549	906572	185	16	28	18,3	28,5	17	30	91	60
909851	909869	185	20	28	18,3	28,5	21	25	91	60
909852	909870	240	10	32	21	32	10,5	38	106	70
906550	906573	240	12	32	21	32	13	38	106	70
906551	906574	240	16	32	21	32	17	38	106	70
906552	906575	240	20	32	21	32	21	38	106	70
906553	906576	300	12	34	23,3	34	13	38	106	70
906554	906577	300	16	34	23,3	34	17	38	106	70
906555	906578	300	20	34	23,3	34	21	38	106	70
906556	906579	400	12	38	26	38,5	13	38	116	73
906557	906580	400	16	38	26	38,5	17	38	116	73
906558	906581	400	20	38	26	38,5	21	38	116	73
906559	906582	500	12	44	29	44	13	44	122	79
906560	906583	500	16	44	29	44	17	44	122	79
906561	906584	500	20	44	29	44	21	44	122	79

rm = round cable multi-wire
sm = sector cable multi-wire

* not normed

Other dimensions available on request. Subject to technical changes. Prices available on request.

* Please observe: Processing must be done exclusively with the C8 compression die intended for it. Only then can you achieve the required pull-out values according to DIN EN 61238 Part 1. The key figures on the compression cable lug and the compression die must match.

HELU-S-PK-AL/CU Aluminium / Copper compression cable lug – straight



Compression cable lug HELU-S-PK-AL/CU

Non-insulated, straight compression lug in eye type design made of aluminium. High quality version for reliable crimping. Designed for conductor type RM and circularly reshaped conductors.

Material

Socket: Al 99,5 and Cu acc. to DIN EN 13601
Surface: bare

Note

Code type indicates the required hexagonal crimping insert.
Al-sleeves are prefilled with contact grease and sealed with plastic plugs
Compression instruction and instruction for assembly see chapter "Technical information".

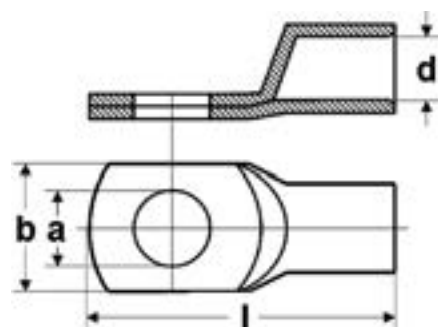

Dimensions

a Diameter of the boring
d Inner diameter of the cable inclusion
b Flange width
l Length

eye type

Part no.	Cross-section RM/SM - SE mm ²	Boring M	a mm	d mm	b mm	l mm	Code type	Weight kg / 1000 items	Unit	
907568	10 - -	8	8,4	5,0	20,0	50,0	10	26,5	25	-
907569	16 - 25	8	8,4	5,6	20,0	60,0	12	35,4	25	-
907570	16 - 25	10	10,5	5,6	20,0	60,0	12	34,2	25	-
907571	25 - 35	8	8,4	6,8	20,0	65,0	12	35,7	25	-
907572	25 - 35	10	10,5	6,8	20,0	65,0	12	34,4	25	-
907573	25 - 35	12	13,0	6,8	26,0	67,0	12	44,5	25	-
907574	35 - 50	8	8,4	8,0	20,0	75,0	14	45,5	25	-
907575	35 - 50	10	10,5	8,0	20,0	75,0	14	44,2	25	-
907576	35 - 50	12	13,0	8,0	26,0	75,0	14	51,5	25	-
907577	50 - 70	8	8,4	9,8	20,0	75,0	16	48,7	25	-
907578	50 - 70	10	10,5	9,8	20,0	75,0	16	47,2	25	-
907579	50 - 70	12	13,0	9,8	26,0	75,0	16	59,9	25	-
907580	70 - 95	8	8,4	11,2	26,0	85,0	18	61,9	10	-
907581	70 - 95	0	10,5	11,2	26,0	10,0	18	73,7	10	-
907582	70 - 95	0	13,0	11,2	26,0	85,0	18	73,7	10	-
907583	70 - 95	16	17,0	11,2	30,0	88,0	18	81,0	10	-
907584	95 - 120	8	8,4	13,2	26,0	86,0	22	102,9	10	-
907585	95 - 120	10	10,5	13,2	26,0	86,0	22	105,9	10	-
907586	95 - 120	12	13,0	13,2	26,0	86,0	22	103,4	10	-
907587	95 - 120	16	17,0	13,2	30,0	88,0	22	109,9	10	-
907588	120 - 150	8	8,4	14,7	26,0	88,0	22	106,8	10	-
907589	120 - 150	10	10,5	14,7	26,0	88,0	22	106,8	10	-
907590	120 - 150	12	13,0	14,7	26,0	88,0	22	104,5	10	-
907591	120 - 150	16	17,0	14,7	30,0	90,0	22	114,5	10	-
907592	150 - 185	8	8,4	16,3	30,0	100,0	25	138,8	5	-
906478	150 - 185	10	10,5	16,3	30,0	100,0	25	138,0	5	-
906172	150 - 185	12	13,0	16,3	30,0	100,0	25	135,7	5	-
906173	150 - 185	16	17,0	16,3	30,0	100,0	25	128,8	5	-
907593	185 - 240	8	8,4	18,3	30,0	102,0	28	183,7	5	-
906479	185 - 240	10	10,5	18,3	30,0	102,0	28	176,1	5	-
906480	185 - 240	12	13,0	18,3	30,0	102,0	28	173,1	5	-
906481	185 - 240	16	17,0	18,3	36,0	105,0	28	196,8	5	-
906482	185 - 240	8	21,0	18,3	36,0	105,0	28	189,7	5	-
906483	240 - 300	10	10,5	21,0	30,0	112,0	32	204,1	5	-
906185	240 - 300	12	13,0	21,0	30,0	112,0	32	204,1	5	-
906484	240 - 300	16	17,0	21,0	36,0	115,0	32	225,8	5	-
906485	240 - 300	20	21,0	21,0	36,0	115,0	32	218,5	5	-

Continuation ▶

HELU-S-PK-AL/CU Aluminium / Copper compression cable lug – straight

eye type

Part no.	Cross-section RM/SM - SE mm ²	Boring M	a mm	d mm	b mm	l mm	Code type	Weight kg / 1000 items	Unit	
906486	300 - -	10	10,5	23,3	30,0	115,0	34	218,4	5	-
906487	300 - -	12	13,0	23,3	30,0	116,0	34	226,4	5	-
906488	300 - -	16	17,0	23,3	36,0	116,0	34	232,2	5	-
906489	300 - -	20	21,0	23,3	36,0	116,0	34	225,0	5	-
906490	400 - -	10	10,5	26,0	36,0	125,0	38	328,7	5	-
906212	400 - -	12	13,0	26,0	36,0	125,0	38	332,7	5	-
906174	400 - -	16	17,0	26,0	36,0	125,0	38	352,6	5	-
906175	400 - -	20	21,0	26,0	36,0	125,0	38	341,5	5	-
906491	500 - -	10	10,5	29,0	44,0	140,0	44	437,1	1	-
906492	500 - -	12	13,0	29,0	44,0	140,0	44	433,3	1	-
906493	500 - -	16	17,0	29,0	44,0	140,0	44	428,3	1	-
906494	500 - -	20	21,0	29,0	44,0	140,0	44	420,8	1	-
907594	625 - -	12	13,0	35,0	50,0	177,0	52	630,1	1	-
907595	625 - -	16	17,0	35,0	50,0	177,0	52	770,0	1	-
907596	625 - -	20	21,0	35,0	50,0	177,0	52	763,0	1	-

Dimensions and specifications may be changed without prior notice.

KAC-U AL/CU-bi-metallic washer



Washer KAC-U

Bi-metallic washer for the processing of aluminium-copper materials.
Only for use in dry areas.

Material

E-Al, one side copper plated

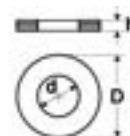

Dimensions

D Outer diameter
d Inner diameter
h Height

Part no.	Size	Inner Ø mm	Outer Ø mm	Thickness mm	Unit	
906049	M8 x 1,5	8,5	18,0	1,0	10	-
906050	M10 x 1,5	11,0	22,0	2,0	10	-
906051	M12 x 1,5	13,0	28,0	2,0	10	-
906052	M14 x 1,5	15,0	28,0	2,0	10	-
906053	M16 x 1,5	17,0	35,0	2,0	10	-

Dimensions and specifications may be changed without prior notice.

HELU-S-PV-AL-DIN Aluminium press connector



Press connector HELU-S-PV-AL-DIN

Press connector for strain-relieved connections of conductors designed acc. to DIN 46267 part 2.

Material

Socket: Al 99,5
Surface: bare

Technical data

Temperature range: up to +120°C

Note

- Code type indicates the required hexagonal crimping insert.
- Part No. 907835 is not standardized.
- Sleeves are prefilled with contact grease and sealed with plastic plug.

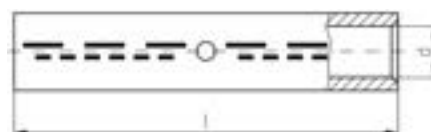

Dimensions

d Inner diameter of the cable inclusion
l Length

blank

Part no.	Cross-section RM/SM - SE mm ²	d mm	l mm	Code type	Weight kg / 1000 items	Unit	
907835	16 - 25	5,6	55,0	12	13,4	50	-
906511	25 - 35	6,8	70,0	12	15,4	50	-
906512	35 - 50	8,0	85,0	14	28,5	50	-
906513	50 - 70	10,0	85,0	16	34,0	25	-
906514	70 - 95	11,5	105,0	18	55,9	25	-
906515	95 - 120	13,2	105,0	22	82,1	10	-
906516	120 - 150	14,7	105,0	22	86,4	10	-
906406	150 - 185	16,3	125,0	25	111,3	10	-
906517	185 - 240	18,5	125,0	28	143,5	10	-
906518	240 - 300	21,0	145,0	32	191,7	10	-
906519	300 - -	23,3	145,0	34	227,1	10	-
906520	400 - -	26,0	210,0	38	359,0	5	-
906521	500 - -	29,0	210,0	44	455,0	5	-

Dimensions and specifications may be changed without prior notice.

HELU-S-PV-AL/CU Aluminium / Copper press connector



Press Connector HELU-S-PV-AL/CU

Press connector for aluminium conductors, strain relieved

Material

Socket: Al 99,5 and Cu acc. to DIN EN 13601
Surface: bare

Note

Al-sleeves are prefilled with contact grease and sealed with plastic plug.

Technical data

Temperature range: up to +120°C



Dimensions

- d1 Inner diameter of the cable inclusion, copper side
- d2 Inner diameter of the cable inclusion, aluminium side
- l Length

blank

Part no.	Cross-section AL RM/SM - SE mm ²	Cross-section CU SE mm ²	Code type AL / CU	d1 CU mm	d2 AL mm	l mm	Weight kg / 1000 items	Unit	
907836	16 - 25	6	12 / 5	3,7	5,6	45,0	9,2	25	-
907837	16 - 25	10	12 / 6	4,4	5,6	45,0	9,4	25	-
907838	16 - 25	16	12 / 8	5,5	5,6	56,0	15,8	25	-
907839	25 - 35	10	12 / 6	4,4	6,8	51,0	9,9	25	-
907840	25 - 35	16	12 / 8	5,5	6,8	61,0	16,1	25	-
907841	25 - 35	25	12 / 10	7,0	6,8	62,0	19,2	25	-
907842	35 - 50	16	14 / 8	5,5	8,0	71,0	21,2	25	-
907843	35 - 50	25	14 / 10	7,0	8,0	71,0	24,1	25	-
907844	35 - 50	35	14 / 12	8,2	8,0	70,0	29,9	25	-
907845	50 - 70	25	16 / 10	7,0	9,8	71,5	26,6	25	-
907846	50 - 70	35	16 / 12	8,2	9,8	71,5	33,4	25	-
907847	50 - 70	50	16 / 14	10,0	9,8	71,5	43,5	25	-
907848	70 - 95	25	18 / 10	7,0	11,2	79,0	36,2	10	-
907849	70 - 95	35	18 / 12	8,2	11,2	79,0	42,2	10	-
907850	70 - 95	50	18 / 14	10,0	11,2	85,0	53,3	10	-
907851	70 - 95	70	18 / 16	11,5	11,2	88,0	64,0	10	-
907852	95 - 120	35	22 / 12	8,2	13,2	79,0	57,4	10	-
907853	95 - 120	50	22 / 14	10,0	13,2	85,0	69,1	10	-
907854	95 - 120	70	22 / 26	11,5	13,2	87,0	78,9	10	-
907855	95 - 120	95	22 / 18	13,5	13,2	94,0	98,8	10	-
907856	120 - 150	50	22 / 14	10,0	14,7	87,0	66,5	10	-
907857	120 - 150	70	22 / 16	11,5	14,7	89,0	76,1	10	-
907858	120 - 150	95	22 / 18	13,5	14,7	97,0	97,7	10	-
907859	120 - 150	120	22 / 20	15,5	14,7	98,0	108,3	10	-
906460	150 - 185	70	25 / 16	11,5	16,3	101,0	95,9	5	-
906495	150 - 185	95	25 / 18	13,5	16,3	108,0	116,6	5	-
906209	150 - 185	120	25 / 20	15,5	16,3	108,0	125,9	5	-
906496	150 - 185	150	25 / 22	17,0	16,3	113,0	155,0	5	-
906497	185 - 240	95	28 / 18	13,5	18,3	108,0	130,0	5	-
906498	185 - 240	120	28 / 20	15,5	18,3	108,0	140,1	5	-
906499	185 - 240	150	28 / 22	17,0	18,3	113,0	169,3	5	-
906500	185 - 240	185	28 / 25	19,0	18,3	116,0	185,3	5	-
906501	240 - 300	120	32 / 20	15,5	21,0	120,0	173,6	5	-
906502	240 - 300	150	32 / 22	17,0	21,0	124,0	200,8	5	-
906503	240 - 300	185	32 / 25	19,0	21,0	127,0	218,4	5	-
906504	240 - 300	240	32 / 28	21,5	21,0	132,0	280,0	5	-
906505	300 - -	150	34 / 22	17,0	23,3	124,0	205,1	5	-
906506	300 - -	185	34 / 25	19,0	23,3	128,0	225,8	5	-
906507	300 - -	240	34 / 28	21,5	23,3	134,0	290,0	5	-
906508	300 - -	300	34 / 32	24,5	23,3	144,0	349,0	5	-

Continuation ▶

HELU-S-PV-AL/CU Aluminium / Copper press connector

blank

Part no.	Cross-section AL RM/SM - SE mm ²	Cross-section CU SE mm ²	Code type AL / CU	d1 CU mm	d2 AL mm	l mm	Weight kg / 1000 items	Unit	
906509	400 - -	185	38 / 25	19,0	26,0	131,0	267,0	1	-
906210	400 - -	240	38 / 28	21,5	26,0	135,0	329,0	1	-
906510	400 - -	300	38 / 32	24,5	26,0	145,0	386,0	1	-
907860	500 - -	240	44 / 28	21,5	29,0	145,0	402,0	1	-
907861	500 - -	300	44 / 32	24,5	29,0	155,0	464,1	1	-
907862	500 - -	400	44 / 38	27,5	29,0	173,0	643,6	1	-

Dimensions and specifications may be changed without prior notice.

HELU-S-PAB-AL-DIN Aluminium Compression Terminal Pin Type



Aluminium Compression Terminal Pin Type

HELU-S-PAB-AL-DIN

Material

• Aluminium Alloy 99,5

Note

- Code type indicates the required hexagonal crimp insert
- AL-sleeves are prefilled with contact grease and sealed with plastic plug

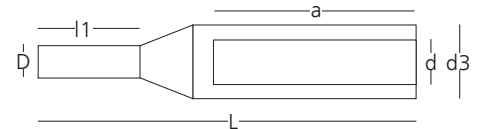

Dimensions

- a depth of bore
- d inner diameter, tube
- d3 outer diameter, tube
- D outer diameter, pin
- l1 bolt length
- L total length

Part no.	Type	cross section		a	d	d3	D	l1	L	key figures	
		mm	mm ²							mm	Type
908301	HELU-S-PAB-AL-DIN 50	50	70	41,0	9,8	16,0	8	25	77	16	
908302	HELU-S-PAB-AL-DIN 70	70	95	48,0	11,2	18,5	10	30	89	18	
908303	HELU-S-PAB-AL-DIN 95	95	120	48,0	13,2	22,0	12	33	93	22	
908304	HELU-S-PAB-AL-DIN 120	120	150	49,0	14,7	23,0	13	38	100	22	
908305	HELU-S-PAB-AL-DIN 150	150	185	58,5	16,3	25,0	14	38	110	25	
908306	HELU-S-PAB-AL-DIN 185	185	240	58,5	18,3	28,5	16	44	120	28	
908307	HELU-S-PAB-AL-DIN 240	240	300	69,0	21,0	32,0	18	44	130	32	
908308	HELU-S-PAB-AL-DIN 300	300	-	69,0	23,3	34,0	20	46	132	34	
908309	HELU-S-PAB-AL-DIN 400	400	-	70,0	26,0	38,5	23	52	140	38	
908310	HELU-S-PAB-AL-DIN 500	500	-	80,0	29,0	44,0	26	58	156	44	

HELU-S-PAB-AL/CU-DIN Bimetallic Compression Terminal Pin Type



Bimetallic Compression Terminal Pin Type

HELU-S-PAB-AL/CU-DIN

Material

- Aluminium Alloy 99,5 (tube) and bare copper (pin) according to DIN EN 13601
- Surface: bare

Note

- Code type indicates the required hexagonal crimp insert
- AL-sleeves are prefilled with contact grease and sealed with plastic plug

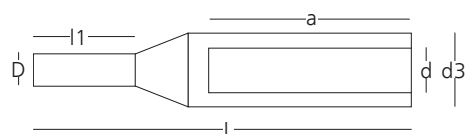

Dimensions

- a depth of bore
- d inner diameter, tube
- d3 outer diameter, tube
- D outer diameter, pin
- l1 bolt length
- L total length

Part no.	Type	cross section		a	d	d3	D	l1	L	key figures	Weight	Unit
		mm	mm ²									
908191	HELU-S-PAB-AL/CU-DIN 16	16	35	26,0	5,6	12,0	6	20	56,0	12	15,40	25
908192	HELU-S-PAB-AL/CU-DIN 25	25	35	31,0	6,8	12,0	6	20	61,5	12	16,00	25
908193	HELU-S-PAB-AL/CU-DIN 35	35	50	41,0	8,0	14,0	7	22	72,5	14	25,10	25
908194	HELU-S-PAB-AL/CU-DIN 50	50	70	41,0	9,8	16,0	8	25	78,0	16	34,50	25
908195	HELU-S-PAB-AL/CU-DIN 70	70	95	48,0	11,2	18,5	10	30	92,5	18	57,80	10
908196	HELU-S-PAB-AL/CU-DIN 95	95	120	48,0	13,2	22,0	12	33	95,0	22	86,40	10
908197	HELU-S-PAB-AL/CU-DIN 120	120	150	49,0	14,7	23,0	12	38	105,0	22	96,70	10
908198	HELU-S-PAB-AL/CU-DIN 150	150	185	58,5	16,3	25,0	12	38	117,5	25	115,20	5
908199	HELU-S-PAB-AL/CU-DIN 185	185	240	58,5	18,3	28,5	14	44	124,0	28	167,80	5
908200	HELU-S-PAB-AL/CU-DIN 240	240	300	69,0	21,0	32,0	16	44	136,5	32	223,00	5
908201	HELU-S-PAB-AL/CU-DIN 300	300	-	69,0	23,3	34,0	18	46	138,0	34	272,40	5
908202	HELU-S-PAB-AL/CU-DIN 400	400	-	70,0	26,0	38,5	20	52	150,0	38	379,00	5
908203	HELU-S-PAB-AL/CU-DIN 500	500	-	80,0	29,0	44,0	22	58	176,0	44	575,20	5

WK-SC-P Shear Bolt Connector

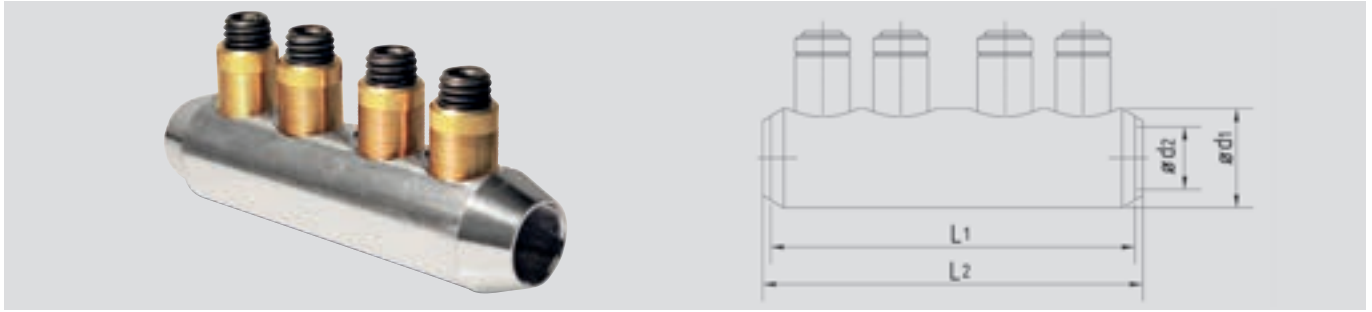

Technical Data

Material: Aluminium alloy
Surface: tin plated
Dimensions: $d_1 = 42 \text{ mm}$
 $d_2 = 26.2 \text{ mm}$
 $L_1 = 220 \text{ mm}$

Design

- with divider
- Conductor channel with transverse grooves and protection against conductor oxidation

These bolt connectors were developed especially for the HELUWIND® WK POWERLINE ALU and successfully tested according to IEC– DIN EN 61238-1 Class A.

SICON bolt connector

185-400 + 500 mm² RE Al/Cu + 300 flex

Thanks to the special design of the bolts, there are no pre-determined breaking points in the threads. Instead the bolt always reliably rips on the surface of the terminal body.

- **No protrusions on the terminal body**
- **Full utilization of the thread load carrying capacity for every conductor cross section**
- **No special tool required**
- **Gentle shearing off of the shear bolt makes tightening easier**

fine-wire	185 - 240 (300 max. Ø 26 mm)	185 - 240 (300 max. Ø 26 mm)
SM 120°	185 (240 pressed round)	185 (240 pressed round)
SE 120°	185 - 240	
SM 90°	185 - 240	185 - 240
SE 90°	185 - 240	
RE	185 - 500	185 - 500
RMV	185 - 400	185 - 400
RM	185 - 400	185 - 400
Conductor types as per DIN 60228 - 09/2005	Cross section range: aluminium conductor	Cross section range: copper conductor

Other conductor cross sections and dimensions on request.

SICON – The first stepless shear bolt

- 1 A standard hexagonal wrench works on a threaded pin which will be screwed into the hole of the stepless compression bolt. The traction is not interrupted by any step or notch on the bolt.
- 2 When screwing in the SICON bolt, the pressure plate loosens on the bottom of the bolt. The bolt now turns on this plate; compared to conventional bolts, no head friction occurs on the conductor. The bolt's torque generates the contact pressure almost independently of the conductor material. This way, a significantly higher contact pressure is achieved for Aluminium conductors and even fine-wired conductors are not damaged.
- 3 The SICON bolt continues to turn until the shearing moment is reached. When screwed in, the thrust bolt is tensioned; on reaching the shearing moment, it stretches axially and tears. Compared with conventional shear bolts, the bolt breaks very smoothly.
- 4 The SICON bolt always shears directly on the surface of the terminal body. This ensures that the protrusion is always minimized, irrespective of the conductor to be connected.

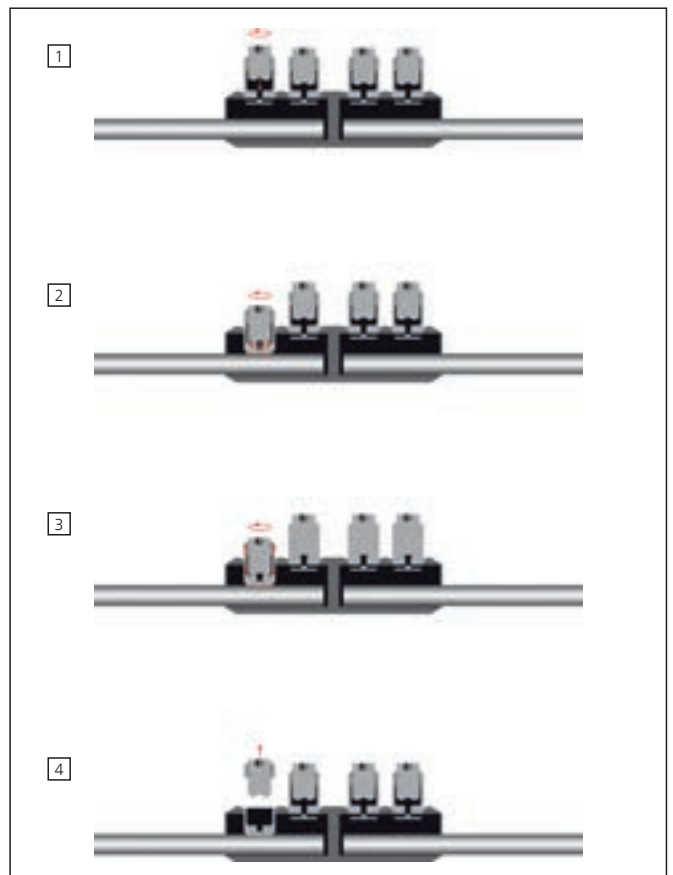

Dimensions and specifications may be changed without prior notice.

WK-SC-T Shear Bolt Connector



Bolt connector with shear bolts for HELUWIND® WK POWERLINE ALU fine-wire aluminium conductors.

A connection technology with dual shear bolts, especially developed for the WK POWERLINE ALU series. This newly-developed bolt technology differs from conventional techniques as the aluminium conductor is contacted in a 2-step-procedure. First of all, the dual bolt technology fastens the fine-wire aluminium conductor. As a second step a mandrel is inserted into the conductor, what completes the conductor's crucial sealing and contacting.

Properties

- Easy and secure connection system for flexible Cl. 5 aluminium cables tested according to IEC-61238-1 Class A.
- New patented two-step shear off bolts provide predetermined torque & ensure reliable and secure contact without damaging fine aluminium strands.
- Easier and faster installation - no tools required.
- Available for cable cross sections 70 mm² through 500 mm².
- Dual connection technology available for connecting the HELUWIND® WK POWERLINE ALU series.

Optional: Reduction Connector

HELUWIND® WK POWERLINE ALU series to Cl. 2 aluminium

HELUWIND® WK POWERLINE ALU series to Cl. 5 copper

Part no. and prices on request.

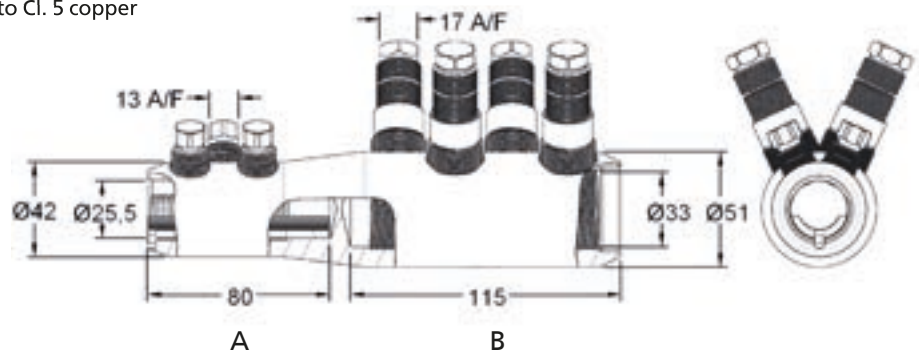

Diameter range table		AL					CU		
A	mm ²	150/400	150/400	150/240	185/300 (300 with 90°)		150 / 400	150/185	300 (Class 5)
	Ø mm	13,7 / 24,6	12,9 / 22,2				13,7 / 24,6		23,5 / 25
B	mm ²					400 (Class 5)			
	Ø mm					27 / 29			

Dimensions and specifications may be changed without prior notice.

WK-SL-T Shear Bolt Cable Lug



Bolt cable lug with shear bolts for HELUWIND® WK POWERLINE ALU fine-wire aluminium conductors.

A connection technology with dual shear bolts, especially developed for the HELUWIND® WK POWERLINE ALU series. This newly-developed bolt technology differs from conventional techniques as the aluminium conductor is contacted in a 2-step-procedure. First of all, the dual bolt technology fastens the fine-wire aluminium conductor. As a second step, a mandrel is inserted into the conductor, what completes the conductor's crucial sealing and contacting.

Properties

- Easy and secure connection system for Cl. 5, flexible aluminium conductors, tested according to IEC-61238-1 Cl. A.
- Patented two-step, shear off bolts provide predetermined torque & ensure reliable and secure contact without damaging fine aluminium strands.
- Easier and faster installation - no tools required.
- Available for cross sections: 70 mm² - 500 mm².
- Dual shear bolt cable lugs are designed for connecting the HELUWIND® WK POWERLINE ALU series.

Part no. and prices on request.

Dimensions and specifications may be changed without prior notice.

Bolt Cable Lug with Shear Head

For copper Cl. 5 and aluminium Cl. 2



Bolt Cable Lug with Shear Head

Properties

- Available for cross sections 120 mm² through 400 mm²
- Tested according to IEC 61238-1 Cl. A
- Up to U₀ /U (U_m) 18/30 (36) kV
- Connector: High-strength aluminium alloy
- Threaded screws: aluminium alloy with multiple shear heads
- Surface: tin-plated for aluminium and copper conductors

Advantages

- Designed with insulation throughout the entire length
- Suitable for indoor and outdoor applications
- Particularly-long sealing length to protect against moisture

Not for fine-wire aluminium stranding.

Part no. and prices on request.

Bolt Connector with Shear Head

For copper Cl. 5 and aluminium Cl. 2



Bolt Connector with Shear Head

Properties

- Available for cross sections 10 mm² through 1000 mm²
- Tested according to IEC 61238-1 Cl. A
- Up to $U_0/U (U_m)$ 18/30 (36) kV
- Connector: High-strength aluminium alloy
- Threaded screws: aluminium alloy with multiple shear heads
- Surface: tin-plated for aluminium and copper conductors

Advantages

- Greater connection area
- Conductor connection canal with longitudinal and lateral grooves, which allows for good electrical contacts and tearing up the oxide coating on the conductors

Not for fine-wire aluminium stranding.

Part no. and prices on request.

Dimensions and specifications may be changed without prior notice.

Mechanical Split Connector with Shear Head

For copper Cl. 5 and aluminium Cl. 2

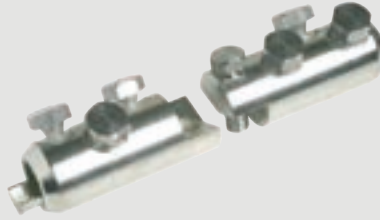

Mechanical Split Connector with Shear Head

Properties

- Available for cross sections 120 mm² through 400 mm²
- Tested according to IEC 61238-1 Cl. A
- Connector: High-strength aluminium alloy
- Threaded screws: aluminium alloy with multiple shear heads
- Surface: tin-plated for aluminium and copper conductors

Advantages

- Greater connection area
- Conductor connection canal with longitudinal and lateral grooves, which allows for good electrical contacts and tearing up the oxide coating on the conductors

Not for fine-wire aluminium stranding.

Part no. and prices on request.

Dimensions and specifications may be changed without prior notice.

HYDAC - Fastening systems in the turret

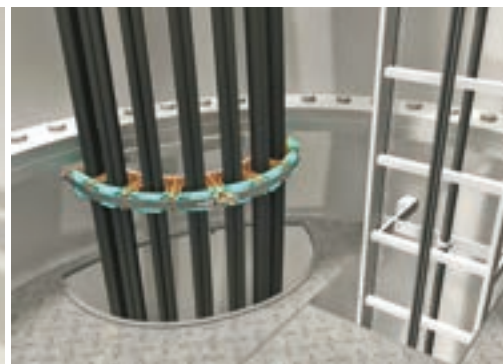
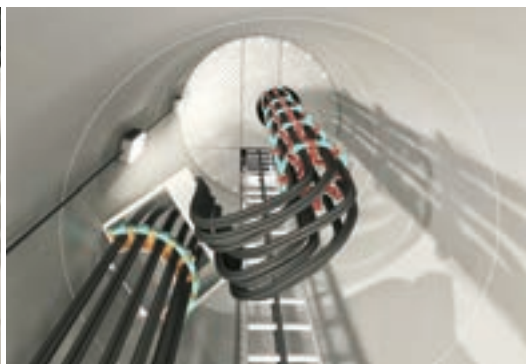

TURRET – “half-moon”
HRFLEX 3x to 9x (AC)



Requirements from the customer for the new cable fastening:

- Modular construction system
- Compact design
- Turret: Simple assembly of the fastening system
- Cable: Fast and simple type of fastening
- Good accessibility to all cables
- Simple to replace the cable
- Compensation of the cable tolerances up to 10%
- Short-circuit proof up to 20 kA
- Fire resistant material
- Temperature independent and reliable retention force of the cable
- No damage of the cable insulation (e.g., pinching)

Advantages:

- Flexible for power cable up to 10% Ø difference
- Cable diameter up to 35mm
- Fast and maintenance friendly assembly in the horizontal and vertical turret.
- For 1-3 power cables through inserts
- Fire resistant acc. to UL94-class V0
- Designed for short-circuit current up to 20 kA
- Better protection of insulation of the power cable
- Suitable for temperatures from -40°C (survival) bis +90°C
- Fast replacability of the individual cables
- Constant pressure force through spring assemblies

TURRET – “star” spacer

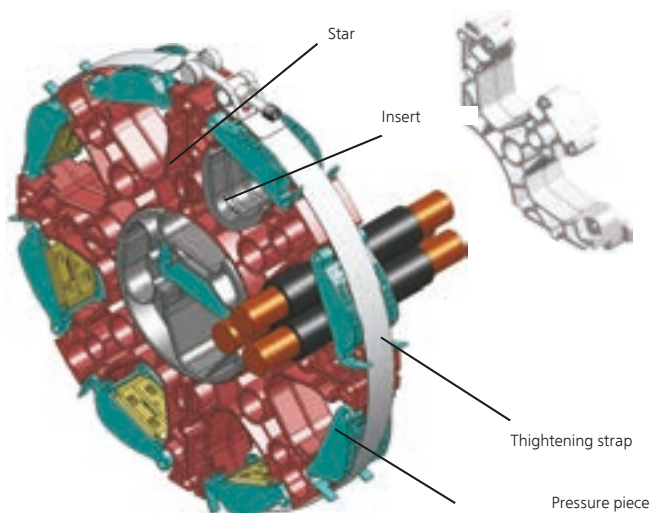

Test and inspections performed:

- Short-circuit test up to 41 kA
(Short-circuit test with ASTA certificate existing)
- Cold test under load -40°C, 20h
- Hot test +90°C (copper core) under load
- Material acc. to UL94 – V0 (fire resistant)
- Load test > 30 days, outside of the premises
- Tensile test of the trigger
- Loading and bending test of the base frame
- Loop test
- Lifetime and aging test of the material
- Salt and spray test

Outstanding tests and certificates:

- GL - certificate

Cable clamps



Cable clamps K

For fastening single-wire and multiple-wire cables.

With additional elastic insert:

- 1) For padding the cable (over an outside diameter of ≥ 60 mm), to avoid damage during loading, or change of the ambient temperature.
- 2) In the area of riser lines of a desired height to accept the weight forces and secure fixation of the cables.
- 3) Fastening of cables with smaller outside diameter to expand the clamping range of the clamp.

Technical Data

Material:	Polyamide, glass fiber reinforced
Diameter range:	18 to 90 mm
Mechanical short-circuit protection:	10000 N
Max. tightening torque of the fastening screws:	5 Nm



Cable clamps KS

For fastening single-wire cable in diagonal bracing.

With additional elastic insert:

- 1) In the area of riser lines of a desired height to accept the weight forces and secure fixation of the cables.
- 2) Expansion of the clamping range of the clamp to fasten cables with smaller outside diameter.
- 3) The hole for a M10 bolt in the lower part of the cable clamps enables a direct fastening, e.g., on floors, walls, lattice, concrete or wood masts.

Technical Data

Material:	Polyamide, glass fiber reinforced
Diameter range:	22 to 46 mm
Mechanical short-circuit protection:	12500 N
Max. tightening torque of the fastening screws:	5 Nm

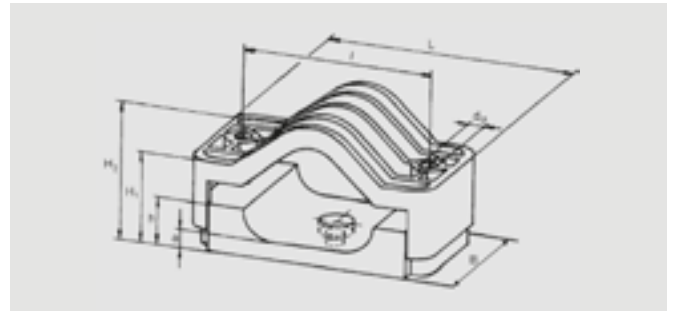
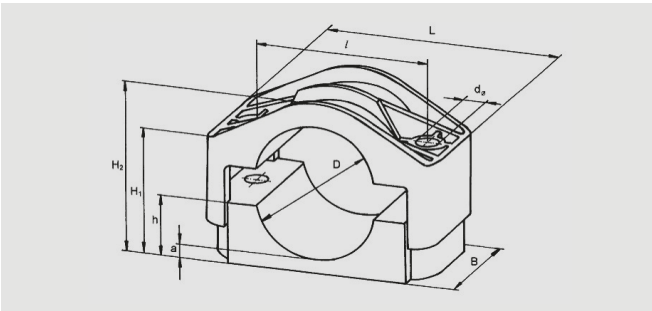

Cable clamps K

Type	D mm	Diameter with an elastic insert in mm	Diameter with an elastic insert in mm	L in mm	B in mm	l in mm	d in mm	H1 in mm	H2 in mm	h in mm	a in mm
K26/38	24-38	21-35	18-32	91	60	60	12	36-47	46-57	19	7
K36/52	36-52	32-49	29-46	108	60	75	12	43-56	56-72	24	8
K50/75	50-75	47-72	44-69	126	60	95	12	51-77	74-98	30	9
K66/90	66-90	63-87	60-84	158	70	120	14	65-89	91-115	42	10

Cable clamps KS

Type	D mm	Diameter with an elastic insert in mm	L in mm	B in mm	l in mm	d in mm	H1 in mm	H2 in mm	h in mm	a in mm
KS 25/36	25-36	22-33	150	80	110	12	55-75	77-97	35	15
KS 33/46	33-46	30-43	170	80	130	12	55-85	95-115	35	19

HELUWIND® WK-Multiclamp

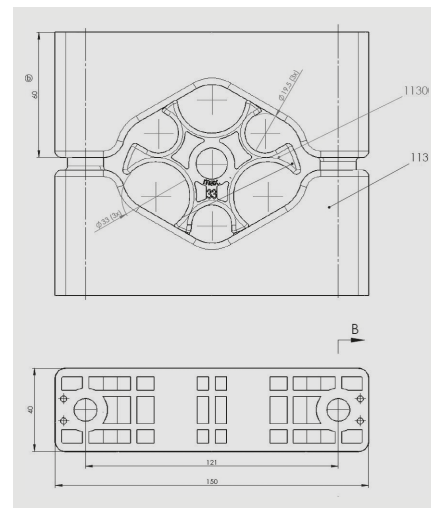

Requirements of the customer for the new cable fastening

- Modular construction: For single or surface mounting (with several layers)
- Clamp bodies and inner adapter made of flame-retardant plastic PPV0: Test and V0 classification corresponding to UL 94 (Vertical Burning Test)
- Fastening accessories (as for example, threaded pins, nuts, cover plates and any kind of sub-construction) made of steel or stainless steel – selection of suitable fastenings based on various test routines – dependent on application surroundings (e.g., dimensions, weight, and insulation of the used cables).

Material PPV0

To further improve the preventative fire protection, wind energy clamps are made out of the flame-retardant plastic PPV0. These were tested corresponding to UL 94 (Vertical Burning Test) and classified in the category V0.

UL 94 is a test method of the Underwriters Laboratories for inter-branch evaluation and classification of the flammability of plastics:

A test specimen is fastened in the vertical position and subjected to a flame for a duration of 10 seconds from the bottom out over an open ignition source.

A second flame treatment was introduced for a duration of 10 seconds directly after extinguishing the test specimen.

V0 then the highest level and classified as the most flame resistant materials: Extinguish clamped test specimen within 10 seconds without burning drops of melted plastic.



Special clamps

Individually fabricated fastening solutions for pipes, cables and other parts:

- Fabricated according to customer specifications or on the basis of own developments
- As machined or die cast version, depending on material, dimensions and quantity
- Fabrication of various plastics (PP oder PA), thermoplastics, elastomer or non-ferrous metals
- Flame-retardant materials according to various international fire protection standards



The Roxtec Sealing Solution

The Roxtec module partitions secure cable and pipe installations in demanding applications in wind-turbine engineering.

Special products for the housing insert and control-cabinet construction sectors are available.

The solution:

Multidiameter™ – the flexible, adaptable Roxtec delayering technology provides thousands of constructors, fitters and operators secure and sophisticated lead-throughs for cables and pipes.

With our wide spectrum of frames and inserts you will achieve perfect sealing in every outer diameter. Even subsequent expansions to finished installations become problem-free.

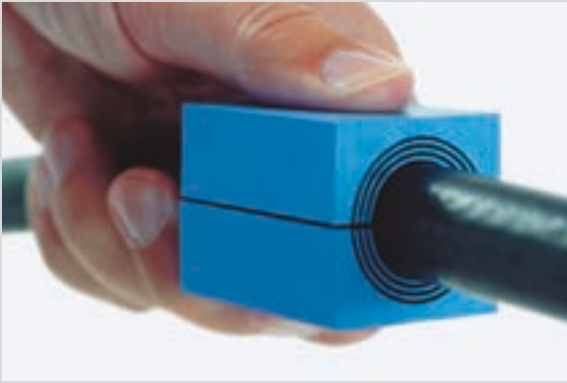
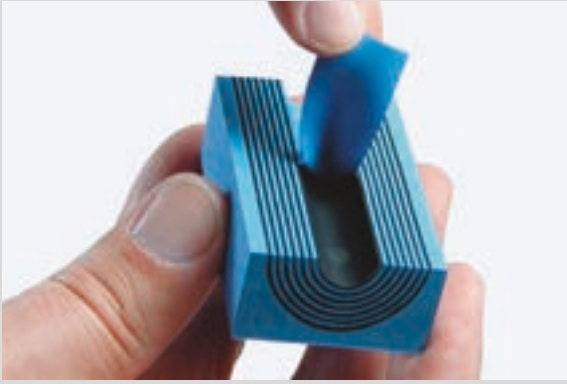

Multidiameter™ Module kits for frame size 6



RM Kit 601



RM Kit 602

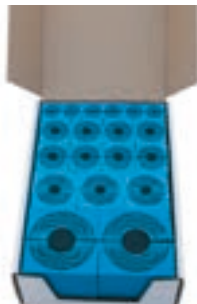

RM Kit 603

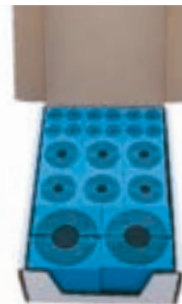

RM Kit 604

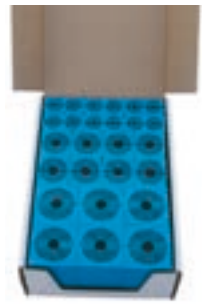

RM Kit 605

The Roxtec Sealing Solution

Example of use

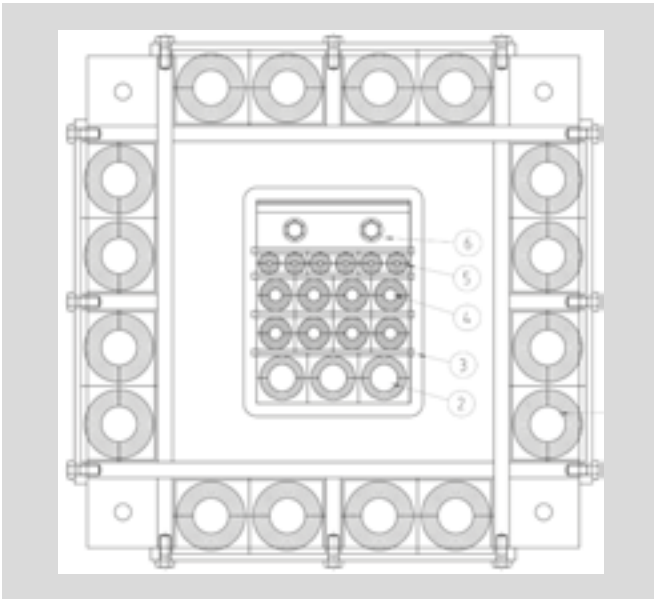
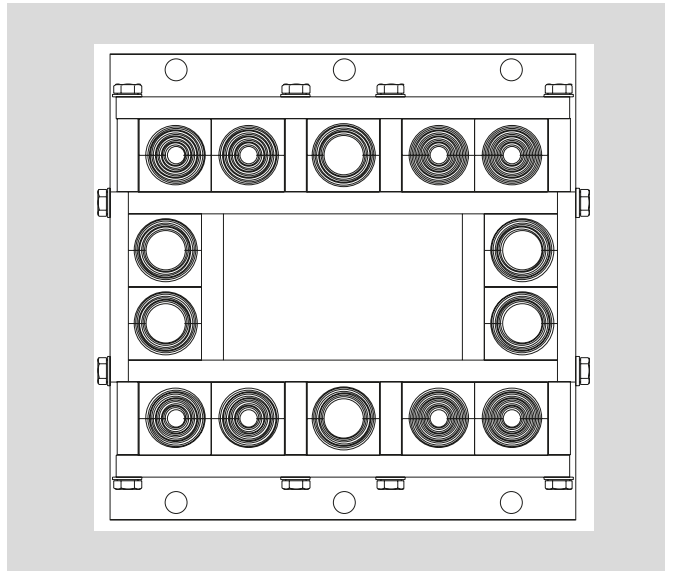

This layout facilitates separating power cables from signal and OWG connections

Separating the power cable in the cable retainers positively influences any arising stagnation temperatures

Multidiameter™ Modules with core

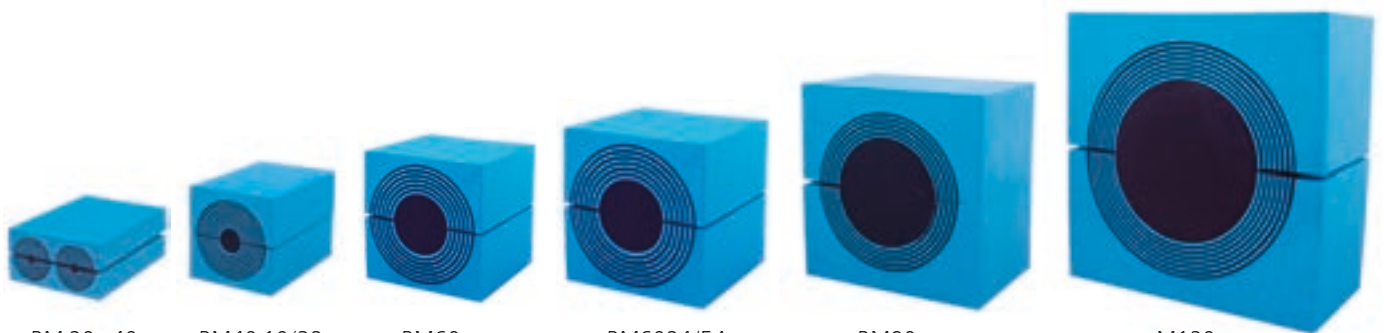

RM 20w40

RM40 10/32

RM60

RM6024/54

RM90

M120

Cable Fittings from Tyco Electronics Raychem GmbH

Cable connection RSTI

Screened, separable connection system RSTI, 630A up to 36kV, cross section: 25mm² - 630mm² for SF6-insulated switchgear with 630A bushings, Type C, 630/1250A according to CENELEC HD506 S1, EN 50180 and EN 50181



Coupling plug RSTI-CC

Screened, separable coupling connection system RSTI-CC, 630A up to 36kV, cross section: 25mm² - 630mm² in combination with connection system RSTI for SF6-insulated switchgear with 630A bushings, Type C, 630/1250A according to CENELEC HD506 S1, EN 50180 and EN 50181



Typical application in a switching system.

Cable Fittings from Tyco Electronics Raychem GmbH

Medium-voltage

MXSU Heat-shrink joint

Heat-shrink joint MXSU for polymeric insulated cables up to 36kV, cross section: 25mm² - 500mm² incl. mechanical connectors



SXSU Heat-shrink joint

Heat-shrink joint SXSU for polymeric insulated cables up to 36kV, cross section: 25mm² - 1200mm² for compression joints



Low-voltage

UAGA Heat-shrink joint

Heat-shrink joint UAGA for polymeric insulated cables up to 1kV, cross section: 1.5mm² - 300mm²



VMDU Heat-shrink joint

Heat-shrink joint VMDU for control cables, cross section: 4 - 75 x 1.5mm² - 2,5mm²



IREV-S indoor termination, shrinking type



IREV-S

The interior end seals are suitable for all single-conductor and three-conductor. Medium-range voltage plastic cables with differing conductor layers and sheath designs up to 18/30(36)kV.

Properties

- safe field effect
- simple assembly
- wider application range
- excellent external layer behaviour
- unlimited conductivity
- immediately operational

Scope of delivery

- Packing unit: 1
- suspensible silicon control element
- sealing band
- creeping current resistant, weather-proof heat shrink-on tube
- assembly instruction
- suspensible silicone sheds

Note

- An additional earthing kit is required for cables with copper sheath.
- Without terminals.
- 1 unit = 1 set with 3 items.

single core

Part no.	Type	Nominal voltage U ₀ /U(U _m)	Cross-section mm ²	Unit	
93190	IREV-S12/1	6/10kV	10,0 - 25,0	1	-
93191	IREV-S12/1	6/10kV	25,0 - 95,0	1	-
94420	IREV-S12/1	6/10kV	95,0 - 240,0	1	-
93192	IREV-S12/1	6/10kV	150,0 - 400,0	1	-
93193	IREV-S12/1	6/10kV	240,0 - 500,0	1	-
94421	IREV-S12/1	6/10kV	400,0 - 800,0	1	-
94422	IREV-S12/1	6/10kV	800,0 - 1000,0	1	-
94423	IREV-S24/1	12/20kV	10,0 - 35,0	1	-
93194	IREV-S24/1	12/20kV	25,0 - 150,0	1	-
93195	IREV-S24/1	12/20kV	70,0 - 240,0	1	-
93196	IREV-S24/1	12/20kV	120,0 - 300,0	1	-
93197	IREV-S24/1	12/20kV	240,0 - 500,0	1	-
94424	IREV-S24/1	12/20kV	630,0 - 1000,0	1	-
93198	IREV-S36/1	18/30kV	35,0 - 70,0	1	-
94425	IREV-S36/1	18/30kV	50,0 - 150,0	1	-
93199	IREV-S36/1	18/30kV	150,0 - 400,0	1	-
93200	IREV-S36/1	18/30kV	500,0 - 800,0	1	-

Dimensions and specifications may be changed without prior notice.

FLEV-S outdoor termination, shrinking type



FLEV-S

The outside end seals are suitable for all single-conductor and three-conductor medium-range voltage plastic cables with differing conductor layers and sheath designs up to 18/30(36)kV.

Properties

- Safe field effect
- Simple assembly
- Wider application range
- Excellent external layer behaviour
- Unlimited conductivity
- Immediately operational

Scope of delivery

- Packing unit: 1
- suspensible silicon control element
- sealing band
- creeping current resistant, weather-proof heat shrink-on tube
- assembly instruction
- suspensible silicone sheds

Note

- An additional earthing kit is required for cables with copper sheath.
- Without terminals.
- 1 unit = 1 set with 3 items.

single core

Part no.	Type	Nominal voltage U ₀ /U(U _m)	Cross-section mm ²	Unit	
93360	FLEV-S12/1	6/10kV	10,0 - 25,0	1	-
93361	FLEV-S12/1	6/10kV	25,0 - 95,0	1	-
94426	FLEV-S12/1	6/10kV	95,0 - 240,0	1	-
93362	FLEV-S12/1	6/10kV	150,0 - 400,0	1	-
93363	FLEV-S12/1	6/10kV	240,0 - 500,0	1	-
94427	FLEV-S12/1	6/10kV	400,0 - 800,0	1	-
94428	FLEV-S12/1	6/10kV	800,0 - 1000,0	1	-
94429	FLEV-S24/1	12/20kV	10,0 - 35,0	1	-
93364	FLEV-S24/1	12/20kV	25,0 - 150,0	1	-
93365	FLEV-S24/1	12/20kV	70,0 - 240,0	1	-
93366	FLEV-S24/1	12/20kV	120,0 - 300,0	1	-
93380	FLEV-S24/1	12/20kV	240,0 - 500,0	1	-
94430	FLEV-S24/1	12/20kV	630,0 - 1000,0	1	-
93367	FLEV-S36/1	18/30kV	35,0 - 70,0	1	-
93368	FLEV-S36/1	18/30kV	50,0 - 150,0	1	-
93369	FLEV-S36/1	18/30kV	150,0 - 400,0	1	-
93370	FLEV-S36/1	18/30kV	500,0 - 800,0	1	-

Dimensions and specifications may be changed without prior notice.

Repair Sleeves for shielded single-conductor plastic cable

with bolt connector - U_0/U_m 6/10 (12) kV to 12/20 (24) kV

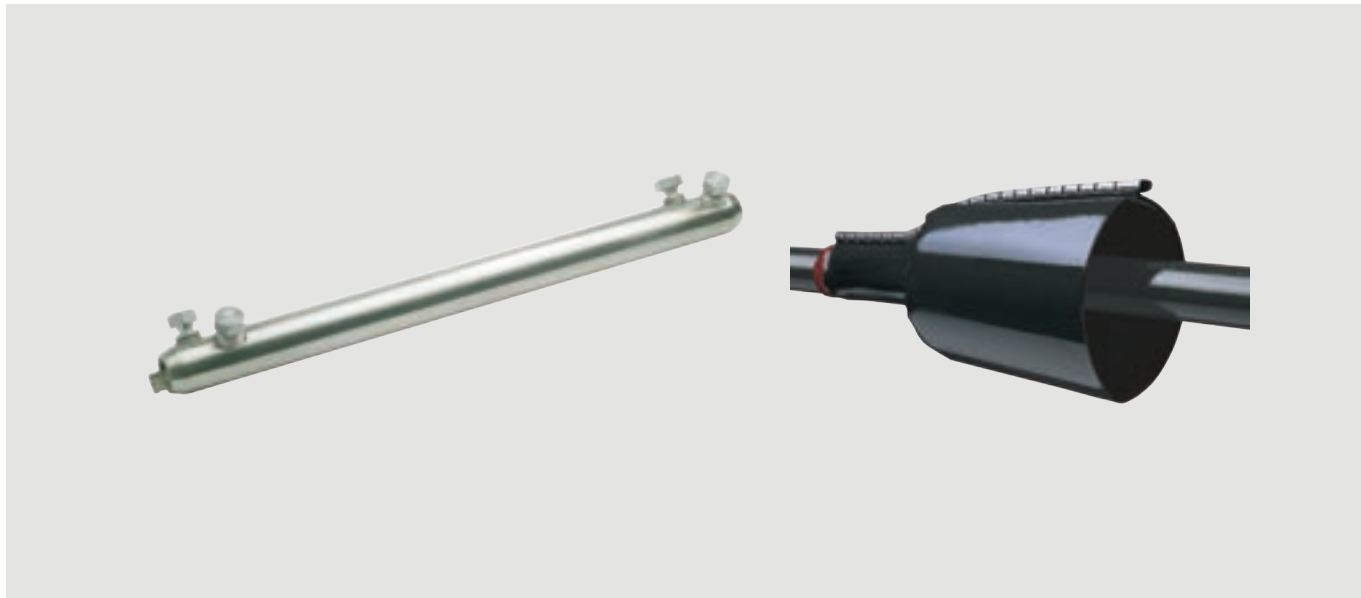

Sleeve

• Sleeve designed for 12 kV and 24kV plastic-insulated cables:

The main design of these sleeves matches the hereafter mentioned MXSU connection sleeves, in which the feeder terminal hose and the sleeve body are roughly twice as long. From prior experience a part of the cable or sleeve will need to be cut out when the cables are damaged, a longer repair bolt connector and a fibre-reinforced cuff are used to restore the conductor connection, which significantly reduces space requirements for the sleeve hole, since the outer hose's stop position is no longer necessary. This allows for bridging gaps up to 320 mm.

Pressure-resistant sleeve

• Pressure-resistant repair sleeves 24 kV:

This sleeve is a special product that was developed during the "Cable Cure" cable refurbishing process. The design matches the repair sleeve for plastic cables. The sleeve's required compressive strength is achieved by additional, pressure-resistant cuffs over the sleeve body. A bolt connector with the appropriate length allows for smooth replacement of the missing conductor piece after disassembling the existing connection sleeves. This application is available upon request.

Cable

• The sleeves described here are used for repairing cable errors and/or defective sleeves up to 320 mm long on plastic-insulated cables of up to 24 kV. This application is available for the following cables: N(A)YSY, N(A)2YSY, N(A)2XS(FL)2Y, N(A)2YHCaY, N(A)2XS(FL)Y. Additional cable types available upon request.

Note

• For cross sections from 25mm² to 500mm²

Part no. and prices on request.

Medium-Voltage Cable Accessories

INLINE Junction Box up to 42 kV

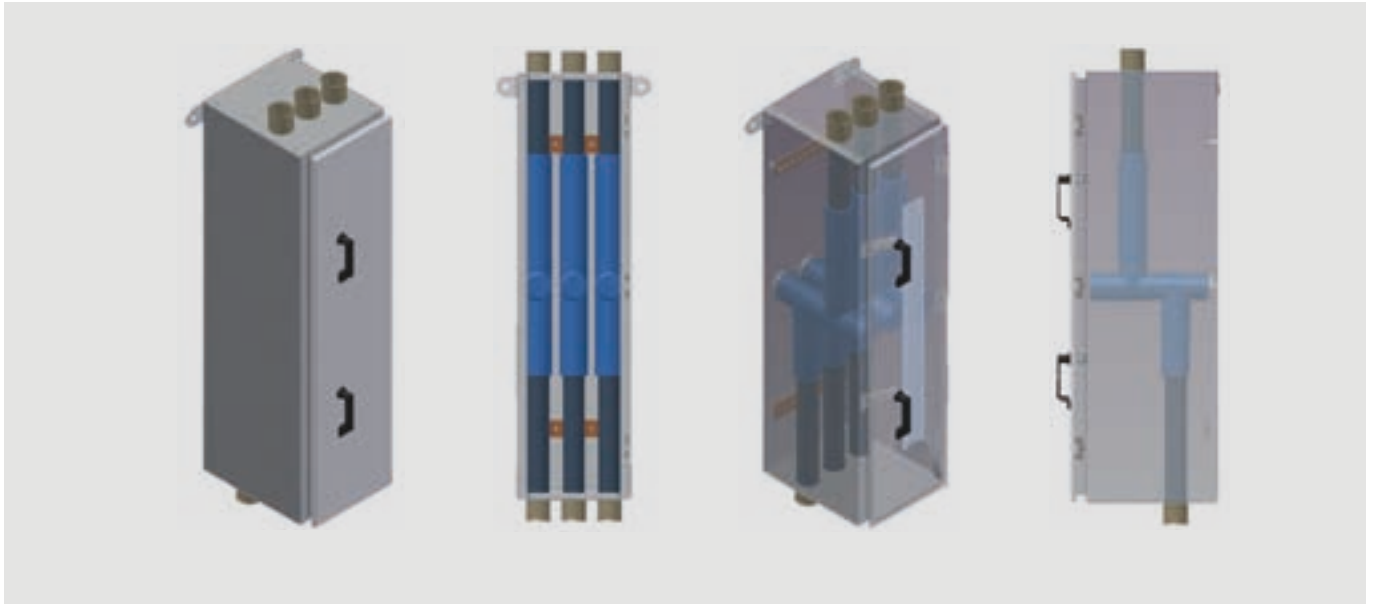

Medium-voltage distributor connector for three insulated cable connectors, up to a max. of 42KV

The MS distributor connector saves a lot of space, thanks to the inline array of the insulated medium-voltage cable connectors, and is easy to install.

- Conductor cross section 25mm² to 300mm²
- Connection for many conductor materials, copper or aluminium cables
- Voltage level up to 42 kV
- Powder-coated metal housing
- On request: corrosion resistant high-grade steel for offshore uses
- Height: 1200mm/Depth: 400mm/Width: 320mm
- For medium-voltage cable connection set type RST1

Part no. and prices on request.

SK-D heat shrink 3:1 - with interior adhesive

polyolefine - thick walled

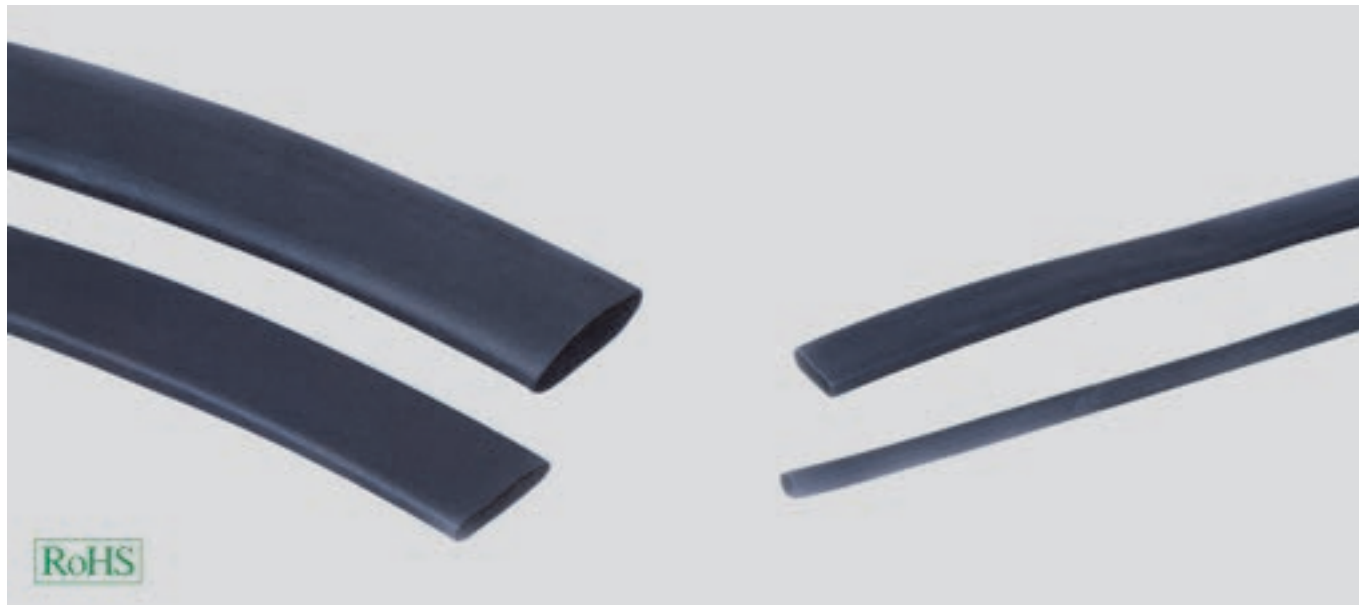

SK-D

Polyolefine shrunk tube with internal adhesive for repairing insulation and sealing electrical components.

For the protection of cable sleeves and terminations for low-voltage applications (600V).

Good protection against impact and abrasion.

Application

- Plant and machine construction
- Robot construction
- Automation technology
- Vehicle construction and shipbuilding
- Installation technology
- Control cabinet construction

Material

PO (Polyolefine) with internal adhesive

Colour: black

- halogen-free

Note

Form of shipment:

1.2 m rods

Approval:

UR-listed up to size 68,1mm

Technical data

Temperature range: -55°C up to +110°C

black

Part no.	Inner Ø before shrinkage mm	Wall thickness mm	Inner Ø after shrinkage mm	Content m	Unit
905344	8,9	1,8	3,0	rods of 1,22m	1
905335	13,0	2,4	4,1	rods of 1,22m	1
905336	19,1	2,4	6,1	rods of 1,22m	1
905337	27,9	3,0	8,9	rods of 1,22m	1
905338	38,1	4,1	11,9	rods of 1,22m	1
905339	50,8	4,1	16,0	rods of 1,22m	1
905340	68,1	4,1	22,1	rods of 1,22m	1
905731	89,9	4,1	30,0	rods of 1,22m	1
905732	119,9	2,0	39,9	rods of 1,22m	1

Dimensions and specifications may be changed without prior notice.

Rollover Insulation Hose

For fixed connection of a 0.6/1kV single-conductor cable



Field of application

- Good versatility; for connecting and sealing single-conductor and coax cables
- Indoors, outdoors, soil, water, installation channels and pipes
- Ideal for locations without flames

Approval

- UL/CSA ANSI

Properties

- The hoses consist of a double-walled endless EPDM pipe filled with lubricant, which is easily rolled over the cable and connector.
- Large field of application, with only 4 types, the full low-voltage range is covered.
- UV-resistant and halogen-free
- Resistant against environmental and chemical influences such as alkalis in the soil.
- Suitable for press connectors (not included)

Advantages

- Reliable protection against moisture and water
- Quick and easy installation without tools
- Can be installed at up to -25°C without significant effort
- Voltage is immediately switched on after successful installation
- Continuous operation temperature range -40°C to +130°C
- Can be stored indefinitely

Part no. and prices on request.

WK-APW 18 Battery-operated compression tool



WK-APW 18 Battery-powered compression tool

- Special tool for crimping cable lugs and connectors up to 1000mm²
- 3 years warranty or 20,000 cycles
- Fast feed in low pressure, with dual-piston hydraulic
- Variable speed for positioning the tool
- Ergonomic design for effortless work
- Service friendly, compact design
- Two-component handle with optimum weight distribution
- Integrated LED for illuminating the working area
- Pressing force: 130 kN
- Max. stroke: 42 mm
- Head opening: 42 mm
- Dimensions: W 95mm x L 430mm x H 310mm
- Weight: approx. 8,7 kg
- Rechargeable battery: Li-Ionen; 18V; 3Ah

Part no.	Type	Unit
909871	WK-APW 18	1

Dimensions and specifications may be changed without prior notice.

C8-Crimping dies for HELUWIND® WK POWERLINE ALU

Part No.	Cross Section
907014	95 mm ² + adapter 906411
906434	150 mm ²
907200	185 mm ²
906446	240 mm ²
906206	300 mm ²
906766	400 mm ²

Please order crimping dies separately!

WK-Electro hydraulic pump with battery



WK-electro-hydraulic, battery-operated pump

- Light, compact and robust structure
- Double piston technology for rapid, high-pressure feed
- Quick tool return by high return conveyor volume
- Pressure monitoring with an electronic pressure sensor
- High-performance battery (lithium-ion) with charge level indicator
- Remote control, 1.5 m
- Power button located on the device and on the remote control
- Remote controlled hydraulic cylinder
- Control by means of microcontroller
- LED-display (green) for correct processing on the device and remote control
- LED-display for battery and processing errors on the device
- Automatic energy save mode after 5 min. in idle
- Crimp and error message history on internal memory (app. 100000 cycles)
- Read out of all cycles and error messages from USB
- Permanent supervision of remaining battery load prevents uncompleted crimping cycles
- Controlled engine drive for long life of gear, engine and battery
- Automatic and manual retract, retract stop function
- Increased cutting frequency by means of automatic cutting detection (pat. pending)
- Integrated service-management
- Software update from USB connection
- Temperature monitor
- Pump can be carried using shoulder strap, carry bag with additional pockets
- Remote control can be fastened to the pump, belt or shoulder strap

Note

Pressing cylinder and crimping head are **not** part of the product. Please order C8 Pressing cylinder and crimping head separately.

Scope of delivery

- Battery-operated pump
- Remote control, 1,5m
- Flexible hose, 1,5m
- USB cable
- Li-Ion battery, 18V, 3,0Ah
- Battery charger
- Software (CD)
- Shoulder strap
- Carry bag with additional pockets

Part no.	Type	Unit
906207	WK-Electro hydraulic pump with battery	1

Dimensions and specifications may be changed without prior notice.

WK-Electro-hydraulic radial-piston-pump (230) with transport cart



WK-Electro-hydraulic radial-piston-pump (230V) with transport cart

- Electrical controls
- Pressure control valve
- Magnet valve
- Oil sight glass
- 3 meter high-pressure hose
- Pump controlled with a foot pedal which is equipped with a high-quality, 3-point safety switch
- Operating pressure: max. 700 bar
- Operating voltage: 230V, 50Hz
- Delivery rate: 0,64l/min
- Nominal capacity: 0,75 kW
- Foot pedal with one switch
- Weight: 32,5 kg

Note

Without cutting and crimping tool
Optional: 400V version available

Scope of delivery

- Battery-operated hydraulic compression tool
- Battery
- Charger
- Transport cart

Part no.	Type	Unit
906721	-	1

Dimensions and specifications may be changed without prior notice.

HELUTOOL HAP 60-2 Battery-powered hydraulic tool in toolbox



HELUTOOL HAP 60-2 Battery hydraulic tool in toolbox

- For processing Cable lugs and Connectors up to 300mm²
- Quick infeed due to doublee piston hydraulic system
- Variable speed fir placing the tool
- Ergonomic design for fatigue-free work
- Easy to service and compact design
- Two-piece component handles with optimal weight distribution
- Powerful Li-Ion battery 18 V
- LED to illumination of the workspace
- Crimping area: 6-300 mm²
- Pressing forces: ca. 60 kN
- Head rotation: 360°
- Opening range: 17 mm
- Battery voltage: 18 V
- Weight incl. battery: approx. 4,4 kg
- Tool dimensions: 330 x 331 x 75 mm

Note

Exclusive inserts

Matching inserts:
HELU-S-PE-SK und HELU-S-PE-WM
Further inserts on request

Scope of delivery

- Battery-powered hydraulic tool
- Battery
- Battery charger
- Carry strap
- Manual
- Transport case

Part no.	Type	Unit
908494	HAP 60-2	1

Dimensions and specifications may be changed without prior notice.



VDEA

A014024

CCC

HARD

H07V-K

CCC

VDEA

HARD

H07V-K

■ READY FOR CHINA



HELUKABEL has been represented in China for more than 12 years and has a wide product program specially developed for the Chinese market. HELUKABEL provides the largest assortment of cables and wires with the „Ready for China“ rating. This makes it possible for us to simplify the complexity of the Chinese certification, which requires significant personnel and financial effort. Talk to us, we would be glad to advise you!

With 3 locations, HELUKABEL is represented in the most important economic regions along the east coast. This includes **Shanghai** located in the Yangtze delta and the metropolitan area of **Beijing**. This is where more

than 30 expert consultants are available for you with advice, of course also in German and English.

In **Taicang**, HELUKABEL produces cables and wires for the Asian market from a 7,000 m² manufacturing facility. Similar to the plants in Germany, the focus is on high quality, flexible and highly-flexible cables and wires, which are produced in accordance with German, Chinese and international standards and norms. Flexible production cells permit short delivery times.

Based on a comprehensive stock program at different locations, cables, wires and accessories can be called up directly at the location without any time delay. The new HELUKABEL logistics centre in Taicang is also used as a product hub for the entire Asian market and offers significant benefits especially for the processing of large projects that are critical with respect to time and volume.

At the same time, we frequently ship by air and sea freight from Germany. More than 70 cable types, have been documented and approved for a quick and easy movement of goods.



HELUKABEL® Production and Logistics Center in Taicang / China

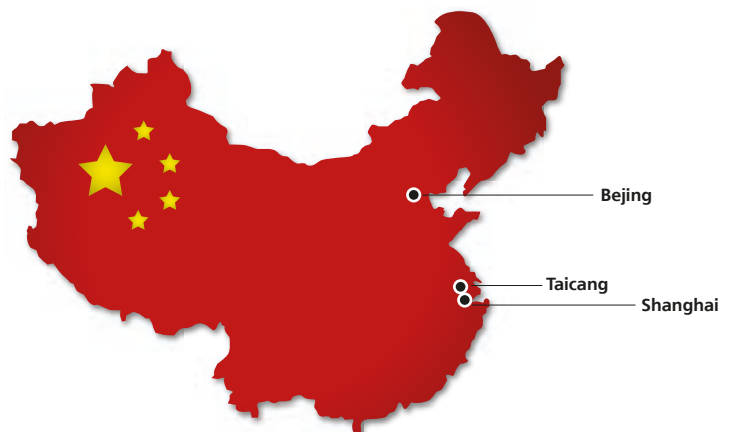

HELUKABEL® Products with CCC-Certificate available on stock.

■ ACHIEVING SUCCESS THROUGH QUALITY AND INNOVATION



Product certificates document the tested quality level of our products

ISO 9000ff is used as the basis for quality management processes carried out at HELUKABEL®. Product certificates issued by accredited institutions also make it easier for you to evaluate your suppliers.

Our continuous quality improvement process enables us not only to maintain a consistently high quality standard, it also ensures continued development and new product development.

Our commitment to protecting the environment can be seen in our state-of-the-art environment management systems.



■ TECHNICAL INFORMATION

Designation		Page
Current ratings for installation conditions	VDE	304
Cables for fixed installation within buildings – C, E, F and G	VDE	304
Cables for fixed installation within buildings – A1, A2, B1 and B2	VDE	305
Current Carrying Capacity for 0,6/1 kV	VDE	306
for NYY, NAYY, NYCY, NYCWY, NAYCWY 0,6/1 kV	VDE	306
for N2XY, NA2XY, N2XCY, NA2XCY 0,6/1 kV	VDE	307
Current ratings – Conversion factors	VDE	308
for grouping on the wall, on the floor, in insulation tubes or in conduit and under the ceiling	VDE	308
for deviating ambient temperature, including HELUWIND®	VDE	309
for grouping of single core cables or cables on troughs and trays	VDE	310
for grouping of multicore cables or cables on troughs and trays	VDE	311
Current Carrying Capacity for XLPE-insulated Medium-Voltage Cables	VDE	312
single core 6/10 kV, 12/20 kV, 18/30 kV	VDE	312
Electrical characteristics of XLPE-insulated Medium-Voltage Cables, 6 – 30 kV		313
Conductor resistance at 20°C		313
Effective resistance at 50 Hz (Alternating-current resistance)		314
Mutual capacitance		315
Short-circuit current carrying capacity up to 30 kV		316
Short-circuit to ground		317
Conversion factors for current carrying capacity for installation of Medium-Voltage Cables, 6 – 30 kV	VDE	318
Rating conversion factors for laying in air*) Single core cables in 3-phase systems	VDE	318
Conversion factors for current carrying capacity for laying in air*) Multicore cable and single core direct current cable	VDE	319
bei Erdverlegung bei Belastungsgrad 0,7 und 1,0		320
Ambient Temperature Correction Factors MV-90/MV-105 Aluminium, Medium-voltage cables		321
2.001V - 5.000V / 5.001V - 35.000V		321
Ambient Temperature Correction Factors / MV-90 / MV-105		322
Conductor strands / Outer Diameter MV-90/MV-105 Aluminium Medium voltage cables		323
Current carrying capacity		324
for Low-Voltage Aluminium CABLE, 600 V – 2 kV RHH RHW-2		324
for HELUWIND® WK POWERLINE ALU, Single Core, finely stranded aluminium conductors (Low voltage)		325
for HELUWIND® WK POWERLINE MS single, Single Core, finely stranded aluminium conductors (Medium voltage)		326
AWG/Kcmil– Conversion table		327
Conductor strands / Outer Diameter MV-90/MV-105 Aluminium Medium voltage cables		327
Current carrying capacity for HELUWIND® WK THERMFLEX 145		328
Current ratings for UL- CSA-cables		329
Instructions for assembly of cable lugs and joints		330
Compression instruction		331
Connection technology for HELUWIND® WK POWERLINE ALU Series		334
Processing instructions for aluminium cable with aluminium and aluminium/copper compression cable lugs and press connectors		335
Glossary of cables and wires		337
Part number index		341

HINT

Due to legal restrictions, the chapter „Technical information“ is completely only available in the printed version.

To order your free copy, please visit www.helukabel.de/publication-order.

■ ELECTRICAL CHARACTERISTICS OF XLPE-INSULATED MEDIUM-VOLTAGE CABLES, 6-30 kV

Conductor resistance at 20°C

cross-section mm ²	maximum value	
	Cu-conductor Ohm/ km	Alu-conductor Ohm/ km
25	0,727	1,20
35	0,524	0,868
50	0,387	0,641
70	0,268	0,443
95	0,193	0,320
120	0,153	0,253
150	0,124	0,206
185	0,0991	0,164
240	0,0754	0,125
300	0,0601	0,100
400	0,0470	0,0778
500	0,0366	0,0605

Conversion factors for the conductor temperatures

Temperature at °C	60	65	70	80	90
Cu-conductor	1,157	1,177	1,196	1,236	1,275
Alu-conductor	1,161	1,181	1,202	1,242	1,282

Conversion formula:

$$R_{\delta} = R_{20} \cdot \frac{234,5 + \delta}{254,5} \quad \text{for Cu-conductor}$$







$$R_{\delta} = R_{20} \cdot \frac{228 + \delta}{248} \quad \text{for Alu-conductor}$$

Conductor temperature at °C = δ
 Conductor resistance at δ °C in Ohm/ km = R_{δ}
 Conductor resistance at 20 °C in Ohm/ km = R_{20}







■ ELECTRICAL CHARACTERISTICS OF XLPE-INSULATED MEDIUM-VOLTAGE CABLES, 6-30 kV

Effective resistance at 50 Hz (Alternating-current resistance)







Copper conductor

Nominal voltage	6/ 10 kV		12/ 20 kV		18/ 30 kV	
Cross-section	approx Ohm/ km					
mm ²						
35	0,671	0,673	0,671	0,672	–	–
50	0,497	0,498	0,496	0,498	0,496	0,497
70	0,345	0,346	0,345	0,346	0,344	0,346
95	0,249	0,251	0,249	0,250	0,249	0,250
120	0,198	0,200	0,198	0,200	0,198	0,199
150	0,163	0,165	0,163	0,165	0,162	0,164
185	0,132	0,134	0,131	0,133	0,131	0,133
240	0,102	0,104	0,101	0,103	0,101	0,103
300	0,082	0,085	0,082	0,084	0,082	0,084
400	0,068	0,071	0,067	0,070	0,067	0,069
500	0,055	0,058	0,055	0,058	0,054	0,057

Aluminium conductor

Nominal voltage	6/ 10 kV		12/ 20 kV		18/ 30 kV	
Cross-section	approx Ohm/ km					
mm ²						
35	1,12	1,12	1,12	1,12	–	–
50	0,825	0,826	0,825	0,826	0,824	0,826
70	0,571	0,572	0,571	0,572	0,571	0,572
95	0,413	0,415	0,413	0,414	0,413	0,414
120	0,327	0,329	0,327	0,329	0,327	0,328
150	0,269	0,271	0,268	0,270	0,268	0,270
185	0,215	0,217	0,215	0,217	0,214	0,216
240	0,165	0,167	0,165	0,167	0,164	0,166
300	0,133	0,135	0,133	0,135	0,133	0,135
400	0,106	0,109	0,106	0,109	0,106	0,108
500	0,085	0,088	0,084	0,087	0,084	0,087

Inductive resistance at 50 Hz







Nominal voltage	6/ 10 kV		12/ 20 kV		18/ 30 kV	
Cross-section	Ohm/ km					
mm ²						
35	0,144	0,158	0,153	0,168	–	–
50	0,136	0,150	0,145	0,159	0,154	0,169
70	0,129	0,143	0,138	0,152	0,147	0,161
95	0,123	0,137	0,131	0,145	0,139	0,154
120	0,118	0,132	0,126	0,140	0,134	0,148
150	0,114	0,128	0,121	0,135	0,129	0,143
185	0,110	0,124	0,117	0,131	0,125	0,139
240	0,105	0,120	0,112	0,126	0,120	0,134
300	0,102	0,116	0,108	0,123	0,115	0,130
400	0,097	0,111	0,103	0,117	0,110	0,124
500	0,094	0,108	0,100	0,114	0,106	0,120

ELECTRICAL CHARACTERISTICS OF XLPE-INSULATED MEDIUM-VOLTAGE CABLES, 6-30 kV

Mutual capacitance

Nominal voltage	6/ 10 kV	12/ 20 kV	18/ 30 kV
Cross-section			
mm ²	μF/ km	μF/ km	μF/ km
35	0,22	0,16	–
50	0,25	0,18	0,14
70	0,28	0,20	0,15
95	0,31	0,22	0,17
120	0,34	0,23	0,18
150	0,37	0,25	0,19
185	0,40	0,27	0,20
240	0,44	0,30	0,22
300	0,48	0,32	0,24
400	0,55	0,36	0,27
500	0,60	0,40	0,29

Inductance

Nominal voltage	6/ 10 kV		12/ 20 kV		18/ 30 kV	
Cross-section						
mm ²	mH/ km	mH/ km	mH/ km	mH/ km	mH/ km	mH/ km
35	0,45	0,76	0,48	0,76	–	–
50	0,42	0,73	0,45	0,74	0,48	0,75
70	0,39	0,70	0,43	0,70	0,45	0,71
95	0,38	0,67	0,41	0,68	0,43	0,68
120	0,36	0,65	0,39	0,65	0,42	0,66
150	0,35	0,63	0,38	0,63	0,41	0,64
185	0,34	0,61	0,36	0,62	0,39	0,63
240	0,32	0,59	0,35	0,59	0,37	0,60
300	0,31	0,57	0,33	0,58	0,36	0,59
400	0,30	0,55	0,33	0,55	0,34	0,56
500	0,29	0,53	0,31	0,53	0,33	0,54

■ ELECTRICAL CHARACTERISTICS OF XLPE-INSULATED MEDIUM-VOLTAGE CABLES, 6-30 kV

Short-circuit current carrying capacity up to 30 kV

Conductor temperature: 90° C

Short-circuit temperature: 250° C

Cable with Cu-conductors

Cross-section	short-circuit time in s (seconds)														
	0,1	0,2	0,3	0,4	0,5	0,6	0,7	0,8	0,9	1,0	1,5	2,0	3,0	4,0	5,0
mm ²	permissible short-circuit in kA														
25	11,3	8,0	6,5	5,7	5,1	4,6	4,3	4,0	3,8	3,6	2,9	2,5	2,1	1,8	1,6
35	15,8	11,2	9,1	7,9	7,1	6,5	6,0	5,6	5,3	5,0	4,1	3,5	2,9	2,5	2,2
50	22,6	16,0	13,1	11,3	10,1	9,2	8,5	8,0	7,5	7,2	5,8	5,1	4,1	3,6	3,2
7031,7	22,4	18,3	15,8	14,2	12,9	12,0	11,2	10,6	10,0	8,2	7,1	5,8	5,0	4,5	
95	43,0	30,4	24,8	21,5	19,2	17,5	16,2	15,2	14,3	13,6	11,1	9,6	7,8	6,8	6,1
120	54,3	38,4	31,3	27,1	24,3	22,2	20,5	19,2	18,1	17,2	14,0	12,1	9,9	8,6	7,7
150	67,8	48,0	39,2	33,9	30,3	27,7	25,6	24,0	22,6	21,5	17,5	15,2	12,4	10,7	9,6
185	83,7	59,2	48,3	41,8	37,4	34,2	31,6	29,6	27,9	26,5	21,6	18,7	15,3	13,2	11,8
240	108,5	76,7	62,7	54,3	48,5	44,3	41,0	38,4	36,2	34,3	28,0	24,3	19,8	17,2	15,3
300	135,7	95,9	78,3	67,8	60,7	55,4	51,3	48,0	45,2	42,9	35,0	30,3	24,8	21,5	19,2
400	180,9	127,9	104,4	90,4	80,9	73,8	68,4	64,0	60,3	57,2	46,7	40,4	33,0	28,6	25,6
500	226,1	159,9	130,5	113,1	101,1	92,3	85,5	79,9	75,4	71,5	58,4	50,6	41,3	35,8	32,0

Cable with Alu-conductors

Cross-section	short-circuit time in s (seconds)														
	0,1	0,2	0,3	0,4	0,5	0,6	0,7	0,8	0,9	1,0	1,5	2,0	3,0	4,0	5,0
mm ²	permissible short-circuit in kA														
25	7,4	5,3	4,3	3,7	3,3	3,0	2,8	2,6	2,5	2,4	1,9	1,7	1,4	1,2	1,1
35	10,4	7,4	6,0	5,2	4,7	4,2	3,9	3,7	3,5	3,3	2,7	2,3	1,9	1,6	1,5
50	14,9	10,5	8,6	7,4	6,6	6,1	5,6	5,3	5,0	4,7	3,8	3,3	2,7	2,4	2,1
70	20,8	14,7	12,0	10,4	9,3	8,5	7,9	7,4	6,9	6,6	5,4	4,7	3,8	3,3	2,9
95	28,2	20,0	16,3	14,1	12,6	11,5	10,7	10,0	9,4	8,9	7,3	6,3	5,2	4,5	4,0
120	35,7	25,2	20,6	17,8	16,0	14,6	13,5	12,6	11,9	11,3	9,2	8,0	6,5	5,6	5,0
150	44,6	31,5	25,7	22,3	19,9	18,2	16,9	15,8	14,9	14,1	11,5	10,0	8,1	7,1	6,3
185	55,0	38,9	31,7	27,5	24,6	22,5	20,8	19,4	18,3	17,4	14,2	12,3	10,0	8,7	7,8
240	71,3	50,4	41,2	35,7	31,9	29,1	27,0	25,2	23,8	22,6	18,4	16,0	13,0	11,3	10,1
300	89,2	63,1	51,5	44,6	39,9	36,4	33,7	31,5	29,7	28,2	23,0	19,9	16,3	14,1	12,6
400	118,9	84,1	68,6	59,5	53,2	48,5	44,9	42,0	39,6	37,6	30,7	26,6	21,7	18,8	16,8
500	148,6	105,1	85,8	74,3	66,5	60,7	56,2	52,5	49,5	47,0	38,4	33,2	27,1	23,5	21,0

■ ELECTRICAL CHARACTERISTICS OF XLPE-INSULATED MEDIUM-VOLTAGE CABLES, 6-30 kV

Short-circuit to ground

Nominal voltage	6/ 10 kV	12/ 20 kV	18/ 30 kV
cross-section mm ²	A/ km	A/ km	A/ km
35	1,2	1,7	–
50	1,4	1,9	2,3
70	1,5	2,1	2,5
95	1,7	2,4	2,7
120	1,9	2,6	2,9
150	2,0	2,7	3,1
185	2,2	3,0	3,3
240	2,4	3,3	3,7
300	2,6	3,5	4,0
400	3,0	4,0	4,4
500	3,3	4,3	4,8

Short-circuit current carrying capacity of copper screens Short-circuit temperature: 350°C

short-circuit time in seconds	load of short-circuit current in kA		
	up to 16 mm ²	25 mm ²	35 mm ²
	kA	kA	kA
s			
0,1	9,7	15,1	21,2
0,2	6,9	10,7	15,1
0,3	5,7	8,9	12,5
0,4	5,0	7,7	10,9
0,5	4,5	7,0	9,8
0,6	4,2	6,4	9,0
0,7	3,9	6,0	8,4
0,8	3,5	5,6	7,9
0,9	3,4	5,3	7,5
1,0	3,3	5,1	7,2
1,5	2,7	4,2	5,9
2,0	2,3	3,6	5,1
3,0	1,9	2,9	4,2
4,0	1,7	2,6	3,6
5,0	1,5	2,3	3,2

Coordination of screen-cross-section

conductor cross-section mm ²	screen-cross-section mm ²
35 to 120	16
150 to 300	25
400 and 500	35

■ CONVERSION FACTORS FOR CURRENT CARRYING CAPACITY FOR INSTALLATION OF MEDIUM-VOLTAGE CABLES, 6-30 KV

Conversion factors for current carrying capacity for cables laid in ground; Load factor 0,7 and 1,0

Fundamental conditions*

Ground temperature	20° C
Thermal resistivity	1,0 K · m/ W
Distance between cables or systems	7 cm
Single core cables laid in trefoil touching arrangement	

Load factor 0,7

Type of insulation	Cable design	Nominal voltage	Number of cables or systems				
			2	4	6	8	10
PVC Three-core cables	Multicore cables	0,6/ 1 to 3,6/ 6 kV	0,86	0,71	0,64	0,60	0,57
		to 6/ 10 kV	0,87	0,71	0,63	0,59	0,54
	Single core cables	0,6/ 1 to 3,6/ 6 kV	0,85	0,70	0,63	0,59	0,56
	Single core cables	to 6/ 10 kV	0,83	0,66	0,57	0,53	0,49
VPE Three-core cables	Multicore cables	0,6/ 1 to 18/ 30 kV	0,85	0,70	0,63	0,59	0,56
	0,6/ 1	to 18/ 30 kV	0,85	0,70	0,63	0,58	0,56

Load factor 1,0

Type of insulation	Cable design	Nominal voltage	Number of cables or systems					
			1	2	4	6	8	10
PVC	Multicore cables Three-core cables	0,6/ 1 to 3,6/ 6 kV	0,81	0,66	0,52	0,46	0,43	0,40
		to 6/ 10 kV	0,82	0,67	0,51	0,45	0,41	0,37
	Single core cables	0,6/ 1 to 3,6/ 6 kV	0,79	0,65	0,51	0,46	0,42	0,40
		to 6/ 10 kV	0,78	0,62	0,47	0,40	0,36	0,33
VPE	Multicore cables	0,6/ 1 to 18/ 30 kV	0,83	0,67	0,53	0,47	0,44	0,41
	Single core cables	0,6/ 1 to 18/ 30 kV	0,81	0,66	0,52	0,47	0,43	0,41

Build-up of systems:

• for single core cables

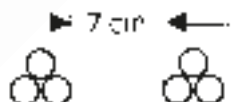

• for multicore cables

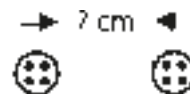

■ CURRENT CARRYING CAPACITY FOR MV 90 / MV 105, ALUMINIUM, MEDIUM-VOLTAGE SINGLE CONDUCTOR

MV 90 / MV 105 Aluminium **2001V - 5000V**

NEC table 310.60(C) ...	(70)		(82)		(68)		(78)		(74)		(76)	
	MV		MV		MV		MV		MV		MV	
Conductor Size AWG or KCMIL	90	105	90	105	90	105	90	105	90	105	90	105
6	85	95	110	115	70	77	66	71	58	65	53	59
4	115	125	140	150	90	100	86	93	76	85	71	79
2	150	165	180	195	125	135	115	125	100	115	96	105
1	175	195	205	220	145	160	130	140	120	135	110	125
1/0	200	225	230	250	170	185	150	160	140	155	130	145
2/0	230	260	265	285	195	215	170	185	160	175	150	165
3/0	270	300	300	320	225	250	195	210	190	210	170	190
4/0	310	350	340	365	265	290	225	245	215	240	200	225
250	345	385	370	395	295	325	250	270	250	280	220	245
350	430	480	445	480	365	405	305	325	305	340	275	305
500	545	605	540	580	460	520	370	400	380	425	340	380
750	710	790	665	720	600	665	470	505	490	545	430	480
1000	855	950	780	840	715	800	545	590	580	645	505	560
1250	980	1095	-	-	-	-	-	-	-	-	-	-
1500	1105	1230	-	-	-	-	-	-	-	-	-	-
1750	1215	1355	-	-	-	-	-	-	-	-	-	-
2000	1320	1475	-	-	-	-	-	-	-	-	-	-

*based on Conductor Temperatures of 90 °C (194 °F) and 105 °C (221 °F) and Ambient Air Temperature of 40 °C (104 °F)

MV 90 / MV 105 Aluminium **5001V - 35000V**

NEC table 310.60(C) ...	(70)		(82)		(68)		(78)		(74)		(76)	
	MV		MV		MV		MV		MV		MV	
Conductor Size AWG or KCMIL	90	105	90	105	90	105	90	105	90	105	90	105
6	87	97	100	110	70	77	70	75	65	72	64	71
4	115	130	130	140	90	100	91	98	84	94	84	94
2	150	170	165	175	125	135	120	130	115	130	115	125
1	175	195	185	200	145	160	135	145	130	150	130	145
1/0	200	225	215	230	170	185	155	165	150	170	150	170
2/0	230	260	245	260	195	215	175	190	175	200	170	190
3/0	270	300	275	295	225	250	200	215	200	225	195	220
4/0	310	345	315	340	265	290	230	245	230	260	225	255
250	345	380	345	370	295	325	250	270	255	290	250	280
350	430	475	415	450	365	405	305	330	310	350	305	340
500	530	590	510	545	460	520	370	400	385	430	380	425
750	685	765	635	680	600	665	455	490	485	540	470	520
1000	825	920	740	795	715	800	525	565	565	640	550	615
1250	950	1055	-	-	-	-	-	-	-	-	-	-
1500	1060	1180	-	-	-	-	-	-	-	-	-	-
1750	1165	1300	-	-	-	-	-	-	-	-	-	-
2000	1265	1410	-	-	-	-	-	-	-	-	-	-

*based on Conductor Temperatures of 90 °C (194 °F) and 105 °C (221 °F) and Ambient Air Temperature of 40 °C (104 °F)

NEC table 310.60(C)(70) insulated single Aluminium conductor cables triplexed in Air

NEC Table 310.60(C)(82) Single Insulated Aluminium Conductors Directly Buried in Earth Temperature of 20°C (68°F)

NEC table 310.60(C)(68) Insulated Single Aluminium Conductor Cables Triplexed in Air Based

NEC Table 310.60(C)(78) Three Single-Insulated Aluminium Conductors in Underground Electrical Ducts (Conductors per Electrical Duct) based on Ambient Earth Temperature of 20°C (68°F)

NEC Table 310.60(C)(74) Insulated Triplexed or Three Single Conductor Aluminium Cables in Isolated Conduit in Air

NEC Table 310.60(C)(76) Insulated Three-Conductor Aluminium Cables in Isolated Conduit

■ AMBIENT TEMPERATURE CORRECTION FACTORS MV-90/MV-105 ALUMINIUM, MEDIUM-VOLTAGE CABLES

Ambient Temperature		Rating of Conductor	
(°C)	(°F)	90°C	105°C
11-15	51-59	1,22	1,18
16-20	60-68	1,18	1,14
21-25	69-77	1,14	1,11
26-30	78-86	1,10	1,07
31-35	87-95	1,05	1,04
36-40	96-104	1,00	1,00
41-45	105-113	0,95	0,96
46-50	114-122	0,89	0,92
51-55	123-131	0,84	0,88
56-60	132-140	0,77	0,83
61-65	141-149	0,71	0,78
66-70	150-158	0,63	0,73
71-75	159-167	0,55	0,68
76-80	168-176	0,45	0,62
81-85	177-185	0,32	0,55

Table 310.60(C)(4) Ambient Temperature Correction Factors

■ CONDUCTOR STRANDS / OUTER DIAMETER MV-90/MV-105 ALUMINIUM, MEDIUM VOLTAGE CABLES

Conductor Size AWG or KCMIL	Number of strands	conductor nom. OD/inch
6	7	0,17
4	7	0,21
2	7	0,27
1	19	0,3
1/0	19	0,34
2/0	19	0,38
3/0	19	0,42
4/0	19	0,48
250	37	0,52
300	37	0,57
350	37	0,62
400	37	0,66
500	37	0,74
600	61	0,81
750	61	0,91
1000	61	1,06

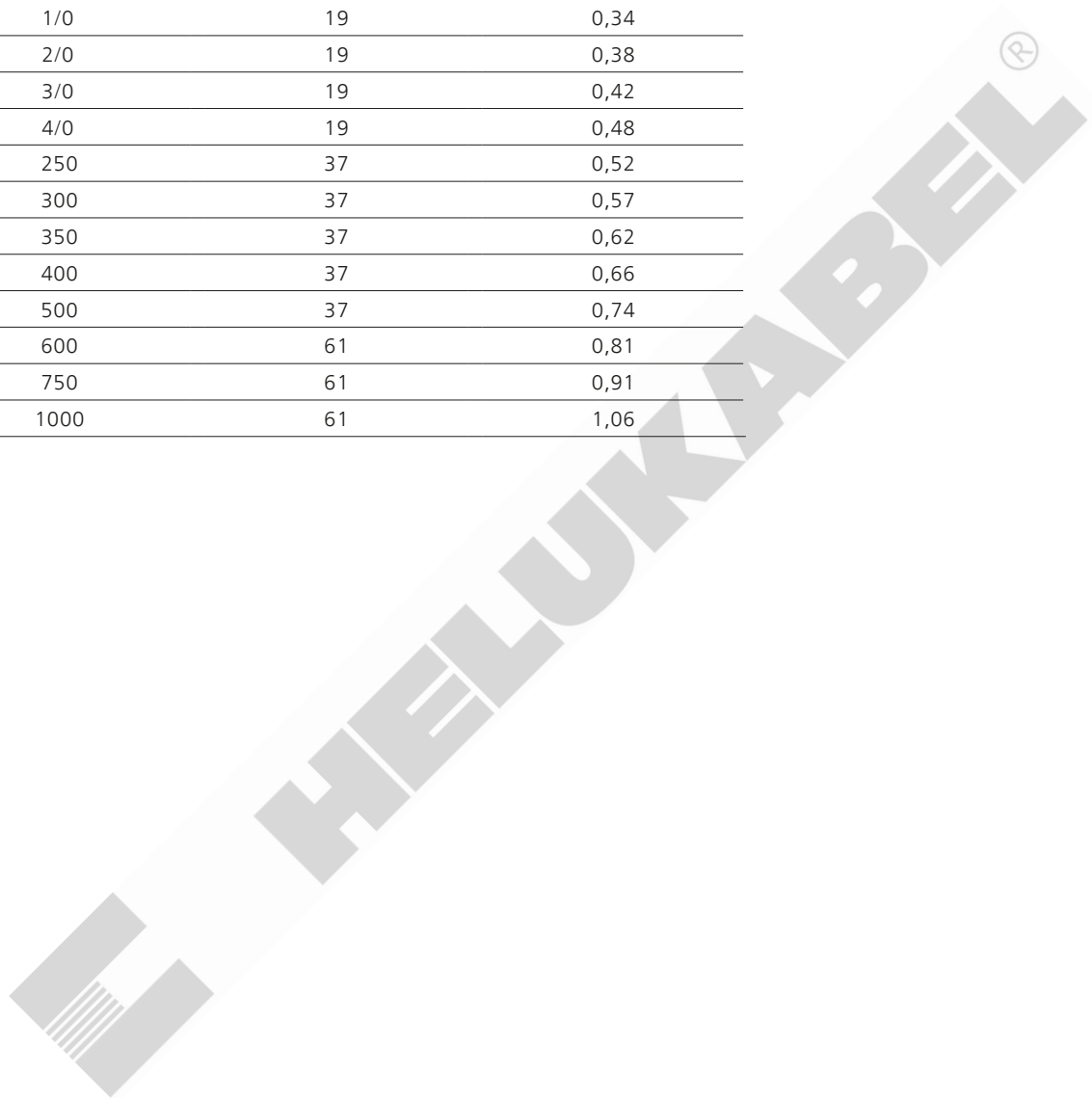

■ CURRENT CARRYING CAPACITY FOR LOW-VOLTAGE ALUMINIUM CABLE, 600 V – 2 KV RHH RHW-2

NEC table 310.15(B) ...	(17)	(16)
Conductor Size AWG or KCMIL	90	105
6	85	55
4	115	75
3	130	85
2	150	100
1	175	115
1/0	205	135
2/0	235	150
3/0	270	175
4/0	315	205
250	355	230
300	395	260
350	445	280
400	480	305
500	545	350
600	615	385
700	670	425
750	700	435
800	725	445
900	790	480
1000	845	500
1250	965	545
1500	1070	585
1750	1185	615
2000	1295	630

NEC Table 310.15(B)(17) (formerly Table 310.17) Allowable Ampacities of Single Insulated

Conductors Rated Up to and Including 2000 V in Free Air, Based on Ambient Temperature of 30 °C (86 °F).

NEC Table 310.15(B)(16) (formerly Table 310.16) Allowable Ampacities of Insulated

Conductors Rated Up to and Including 2000 V, 60 °C Through 90 °C (140 °F Through 194 °F),

Not More Than Three Current-Carrying Conductors in Raceway, Cable, or Earth (Directly Buried), Based on Ambient Temperature of 30 °C (86 °F).

■ CURRENT CARRYING CAPACITY FOR HELUWIND® WK POWERLINE ALU, SINGLE CORE, FINELY STRANDED ALUMINIUM CONDUCTORS (LOW VOLTAGE)

Reduction factors for a deviating type of laying, as well as ambient temperatures and accumulation of the systems

Current carrying capacity values at 30 degrees ambient temperature, laid in air.

Cross section	Standard values Alu 90 degrees on conductor	Values Alu 105 degrees on conductor*
70 mm ²	262 A	292 A
95 mm ²	320 A	356 A
120 mm ²	384 A	423 A
150 mm ²	426 A	475 A
185 mm ²	493 A	549 A
240 mm ²	583 A	660 A
300 mm ²	666 A	776 A
400 mm ²	755 A	927 A

* up to 3000 hours

Correction factors for calculating the current carrying capacity

1. Correction due to type of laying can be taken from the technical part [catalogue Cables, Wires & Accessories](#).
2. Correction for the calculation of the current carrying capacity when laying in the triple bundle. Reduction according to the VDE table 0.77, at 30 degrees ambient temperature.
3. More corrections for the accumulation of one-wire cables or lines in troughs and on platforms can be taken from the technical part [catalogue Cables, Wires & Accessories](#).
4. Correction for the calculation of the current carrying capacity according to IEC 60364-5-523 Tap 52-D1 or VDE 02984-4 Table 15 for the ambient temperature.
5. Correction for 3 and 4 core cables 0,7

Temperature	Conversion factor
30 degrees	1
35 degrees	0,96
40 degrees	0,91
45 degrees	0,87
50 degrees	0,82

Subject to technical changes.

■ CURRENT CARRYING CAPACITY FOR HELUWIND® WK POWERLINE MS SINGLE, SINGLE CORE, FINELY STRANDED ALUMINIUM CONDUCTORS (MEDIUM VOLTAGE)

Current-carrying values, at 30 degrees ambient temperature,
freely placed in the air.

No. cores x cross section mm ²	3,6/6 (7,2) kV A	12/20 (24) kV A	18/30 (36) kV A
50	211	205	201
70	266	258	252
95	321	311	304
120	374	362	352
150	432	417	405
185	494	476	461
240	588	566	548
300	679	654	633
400	802	772	747

Short circuit current 1 sec.

No. cores x cross section mm ²	3,6/30 KV A
50	4860
70	6789
95	9170
120	11550
150	14410
185	17750
240	22980
300	28680
400	38200



■ AWG/KCMIL– CONVERSION TABLE

AWG/ kcmil Size	Cross Section mm ²	AWG/ kcmil Size	Cross Section mm ²	AWG/ kcmil Size	Cross Section mm ²	Cross Section mm ²	AWG/ kcmil Size
30	0,05	10	5,26	400	202,68	95	187,48
29	0,06	9	6,63	444	225,00	120	236,80
28	0,08	8	8,37	450	228,02	240	473,65
27	0,10	7	10,55	500	253,35	300	592,06
26	0,13	6	13,30	535	271,20	400	789,09
25	0,16	5	16,77	600	304,03	500	986,76
24	0,20	4	21,15	646	327,30	600	1184,23
23	0,26	3	26,67	700	354,70		
22	0,33	2	33,63	750	380,03		
21	0,41	1	42,40	777	393,80		
20	0,52	1/0	53,47	800	405,37		
19	0,65	2/0	67,42	900	456,04		
18	0,82	3/0	85,02	929	470,70		
17	1,04	4/0	107,21	1000	506,71		
16	1,31	250	126,68	1111	563,00		
15	1,65	262	132,80	1250	633,38		
14	2,08	300	152,01	1500	760,06		
13	2,62	313	158,60	1750	886,74		
12	3,31	350	177,35	2000	1.013,42		
11	4,17	373	189,00				

■ CURRENT RATINGS FOR HELUWIND® WK THERMFLEX 145

For permanent operating to the ambient temperature of 30° C. Conversion factors for the deviating site operation conditions – see tables below.

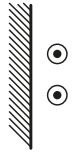
Sufficiently large or ventilated rooms in which the ambient temperature is not noticeably increased by the heat losses from the cables. Protection should be taken from the solar radiation etc.

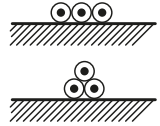
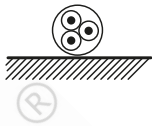
Installation				
Conversion factors for grouping	-	to table 1	to table 2	to table 3
Cross-section in mm ²	Current ratings in Ampere (A) up to 30° C ambient temperature			
0,25	13	12	9	7
0,33	17	15	11	9
0,50	19	18	12	10
0,75	24	23	17	13
1,0	31	30	20	17
1,5	39	36	25	20
2,5	51	48	33	26
4	68	65	45	36
6	88	84	58	46
10	121	116	80	64
16	160	152	106	85
25	211	200	140	111
35	261	248	172	138
50	320	304	211	169
70	411	391	272	217
95	502	476	331	265
120	587	558	387	310
150	680	646	449	359
185	781	743	516	413
240	931	884	614	492
300	1070	1070	1070	1070

Conversion factors for grouping

Number of single core cables for 2-phase or 3-phase systems		1	2	3	4	5	6	7	8	9	10	12
Table 1	Factor	1,00	0,94	0,90	0,90	0,90	0,90	0,90	0,90	0,90	0,90	0,90
Table 2	Factor	1,00	0,85	0,79	0,75	0,73	0,72	0,72	0,71	0,70	-	-
Table 3	Factor	1,00	0,80	0,70	0,65	0,60	0,57	0,54	0,52	0,50	0,48	0,45

Conversion factors for deviating ambient temperatures

Temperature in °C	20	30	40	50	60	70	80	90	95	100	105	110	115
Factor	1,05	1,00	0,94	0,88	0,82	0,75	0,67	0,58	0,53	0,47	0,41	0,35	0,24

■ CURRENT RATINGS FOR UL- CSA-CABLES

AMBIENT TEMPERATURE 30°C

Abstract of NEC Tabelle 310-17
Allowable ampacity (in Ampere) of **conductors**,
rated 0 – 2000 Volts, in free air.

Conductor size	Temperature Rating of Conductor		
	60°C (140 °F)	75°C (167 °F)	90°C (194 °F)
AWG or kcmil (MCM)			
18	-	-	18
16	-	-	24
14	25	30	35
12	30	35	40
10	40	50	55
8	60	70	80
6	80	95	105
4	105	125	140
3	120	145	165
2	140	170	190
1	165	195	220
1/0	195	230	260
2/0	225	265	300
3/0	260	310	350
4/0	300	360	405
250	340	405	455
300	375	445	505
350	420	505	570
400	455	545	615
500	515	620	700
600	575	690	780

Abstract of NEC Tabelle 310-16
Allowable ampacity (in Ampere) of insulated conductors,
rated 0 – 2000 Volts. **NOT MORE THAN three Conductors**
in raceway or cable ore Earth (direct burial).

Conductor size	Temperature Rating of Conductor		
	60°C (140 °F)	75°C (167 °F)	90°C (194 °F)
AWG or kcmil (MCM)			
18	-	-	18
16	-	-	24
14*	25	30	35
12*	30	35	40
10*	40	50	55
8	60	70	80
6	80	95	105
4	105	125	140
3	120	145	165
2	140	170	190
1	165	195	220
1/0	195	230	260
2/0	225	265	300
3/0	260	310	350
4/0	300	360	405
250	340	405	455
300	375	445	505
350	420	505	570
400	455	545	615
500	515	620	700
600	575	690	780

* Note Unless otherwise specifically permitted elsewhere in the NEC, the overcurrent protection for conductor types marked with an * shall not exceed 15 amperes for AWG 14, 20 amperes for AWG 12 and 30 amperes for AWG 10, after any correction factors for ambient temperature and numbers of conductors have been applied.

Correction factors for ambient temperatures other than 30 °C

Ambient temperature in °C	60°C (140 °F)	75°C (167 °F)	90°C (194 °F)
21-25	1,08	1,05	1,04
26-30	1,00	1,00	1,00
31-35	0,91	0,94	0,96
36-40	0,82	0,88	0,91
41-45	0,71	0,82	0,87
46-50	0,58	0,75	0,82
51-55	0,41	0,67	0,76
56-60	-	0,58	0,71
61-70	-	0,33	0,58
71-80	-	-	0,41

Correction factors for more than three current-carrying conductors in a raceway or cable.

Number of current-carrying conductors	Correction factor
4 bis 6	0,80
7 bis 9	0,70
10 bis 20	0,50
21 bis 30	0,45
31 bis 40	0,40
41 und mehr	0,35

■ INSTRUCTIONS FOR ASSEMBLY OF CABLE LUGS AND JOINTS – GENERAL



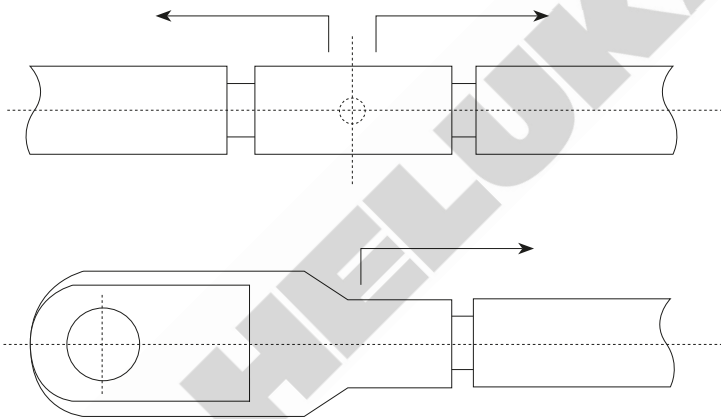



























1. The measurements of the cable lugs/joints as well as their cross-section assignment have to be taken from the catalogue.
2. The end of the cable has to be cut right-angled to the joint and to be stripped ca. 10 % corresponding to the length of the cable lug receptacle. (The receptacle elongates a bit during the compression)
3. The wire ends have to be cleaned thoroughly of dirt and oxide rests prior to the compression. Sector wires have to be rounded.
4. The wire is pushed as far as it will go in the cable lug receptacle, or rather to the middle of the joint.
5. Prior to the compression it has to be checked if the wire and the cable lug, or rather the joint, have the same cross-section marking and match according to the catalogue.
6. It has to be detected if the compression tool is ready for the montage with the right compression insert. This information is written in the catalogue of the producer or rather in the operating instructions of the compression tool, for each series and every cross-section.
7. The compression process, with cable lug and joint, happens from the end of the cable in the direction of the end of the receptacle (see sketch).



The number of compressions is based on the following tables.

■ COMPRESSION INSTRUCTION

Minimum number of necessary compressions when using HELU-S-RK tubular lugs and -joints HELU-S-SV (WM-compression)













































Cross-section in mm	Compression Number x Width	HWW 6/50 907612	HWW 10/120 907613	HMPi 20 907614	HHPi 20 908286	HAP 60-2 908494
6	1 x 5 mm					
	1 x 7 mm					
10	1 x 5 mm					
	1 x 7 mm					
16	2 x 5 mm					
	1 x 7 mm					
25	2 x 5 mm					
	1 x 12 mm					
35	2 x 5 mm					
	1 x 10 mm					
	1 x 12 mm					
50	2 x 5 mm					
	1 x 12 mm					
70	2 x 5 mm					
	1 x 12 mm					
95	2 x 5 mm					
	1 x 12 mm					
120	3 x 5 mm					
	2 x 7 mm					
	1 x 12 mm					
150	3 x 5 mm					
	2 x 7 mm					
185	3 x 5 mm					
	2 x 7 mm					
	2 x 10 mm					
240	3 x 5 mm					
	3 x 7 mm					
	2 x 13 mm					
300	4 x 5 mm					
	3 x 7 mm					
	2 x 13 mm					

Important : The „instructions for assembly of cable lugs and joints“ have to be followed when producing compressions.
 Joints : Minimum number of necessary compressions per side.



■ COMPRESSION INSTRUCTION

Minimum number of necessary compressions when using CU-compression cable lugs of HELU-S-PK-CU-DIN and HELU-S-PV-CU-DIN series

Cross-section in mm	Index	Compression Number x Width	HMPi 20 907614	HHPi 20 908286	HAP 60-2 908494
6	5	1 x 5 mm			
		1 x 7 mm			
10	6	1 x 5 mm			
		1 x 7 mm			
16	8	2 x 5 mm			
		1 x 12 mm			
25	10	2 x 5 mm			
		1 x 12 mm			
35	12	2 x 5 mm			
		1 x 10 mm			
		1 x 12 mm			
50	14	3 x 5 mm			
		1 x 12 mm			
70	16	3 x 5 mm			
		1 x 12 mm			
95	18	3 x 5 mm			
		4 x 5 mm	 * DB earthing		
		2 x 10 mm			
120	20	3 x 5 mm		 * DB earthing	
		4 x 5 mm			
		2 x 10 mm			
150	22	4 x 5 mm			
		2 x 10 mm			
185	25	4 x 5 mm			
		2 x 10 mm			
240	28	4 x 5 mm			
		2 x 13 mm			
300	32	4 x 5 mm			
		4 x 7 mm			
		2 x 13 mm			

Important : The „instructions for assembly of cable lugs and joints“ have to be followed when producing compressions.
 Joints : Minimum number of necessary compressions per side (hexagonal compression)

Key:



Hexagonal compression

■ COMPRESSION INSTRUCTION

Minimum number of necessary compressions when using HELUKABEL-compression cable lugs and -joints
 HELU-S-PK-AL-DIN / HEL U-S-PV-AL-DIN / HEL U-S-PK-AL-FG / HELU-S-PK-AL/CU / HEL U-S-PAB-AL-DIN /
 HELU-S-PAB-AL/CU-DIN of Aluminium (on AL/CU f or compression of the aluminium-side)-series made of aluminium.

Cross-section in mm	Index	Compression Number x Width	HMPi 20 907614	HPi 20 908286	HAP 60-2 908494	WK APW 18 909871	
10	10	2 x 5 mm 1 x 12 mm					
16	10	3 x 5 mm 1 x 12 mm					
	12	3 x 5 mm 1 x 10 mm 1 x 12 mm					
25	12	4 x 5 mm					
		1 x 10 mm 2 x 12 mm					
35	14	5 x 5 mm 2 x 12 mm					
50	16	5 x 5 mm 2 x 12 mm					
70	18	6 x 5 mm 3 x 10 mm					
95	22	6 x 5 mm 3 x 10 mm					
120	22	6 x 5 mm 3 x 10 mm					
150	25	6 x 5 mm 3 x 10 mm					
185	28	6 x 5 mm 3 x 13 mm					
240	32	6 x 5 mm					
		5 x 7 mm 3 x 13 mm					
300	34	3 x 13 mm					
400	38	3 x 16 mm					
500	44	3 x 16 mm					

Important : The „instructions for assembly of cable lugs and joints“ have to be followed when producing compressions.
 Joints : Minimum number of necessary compressions per side.

- ¹ Conductor cross-section ALU Powerline 240mm²
- ² Conductor cross-section ALU Powerline 300mm²
- ³ Conductor cross-section ALU Powerline 400mm²

Page 334 Connection technology overview WK Powerline ALU

Key:		
	Hexagonal compression	C8 compression

■ CONNECTION TECHNOLOGY FOR HELUWIND® WK POWERLINE ALU Series

		Cross-section mm ²									
		drilling	50	70	95	120	150	185	240	300	400
HELU-S-PK-AL-DIN 		10	907873	907875	907877	907880	906459	-	-	-	-
		12	907874	907876	907878	907881	906436	906463	906469	906472	906475
		16	-	-	907879	907882	906461	906464	906470	906473	906476
		20	-	-	-	-	906462	906465	906471	906474	906477
HELU-S-PK-AL-FG 		10	-	-	906539	906541	906544	906547	-	-	-
		12	-	-	906540	906542	906545	906548	906553	906556	906559
		16	-	-	-	906543	906546	906549	906554	906557	906560
		20	-	-	-	-	-	-	906555	906558	906561
HELU-S-PK-AL-FG 		10	-	-	906562	906564	906567	906570	-	-	-
		12	-	-	906563	906565	906568	906571	906576	906579	906582
		16	-	-	-	906566	906569	906572	906577	906580	906583
		20	-	-	-	-	-	-	906578	906581	906584
HELU-S-PK-AL/CU 		10	907578	907581	907585	907589	906478	906479	906486	906490	906491
		12	907579	907582	907586	907590	906172	906480	906487	906212	906492
		16	-	907583	907587	907591	906173	906481	906488	906174	906493
		20	-	-	-	-	-	906482	906489	906175	906494
HELU-S-PV-AL-DIN 			-	-	906515	906516	906406	906517	906519	906520	906521
HELU-S-PAB-AL-DIN 			908301	908302	908303	908304	908305	908306	908308	908309	908310
HELU-S-PAB-AL/CU-DIN 			908194	908195	908196	908197	908198	908199	908201	908202	908203
WK-SC-P shear bolt connector 			-	-	-	-	-	on request		-	
WK-SC-T shear bolt connector 			-	-	-	on request		on request	on request		
WK-SL-T shear bolt cable lug 			-	-	-	on request		on request	on request		
HELU-S-PV-Al/CU 		Alu/CU	150/70	150/95	150/120	150/150	185/95	185/120	185/150	185/185	
			906460	906495	906209	906496	906497	906498	906499	906500	
		Alu/CU	240/150	240/185	240/240	300/185	300/240	300/300	400/240	400/300	400/400
			906505	906506	906507	906509	906210	906510	907860	907861	907862

Dimensions and specifications may be changed without prior notice.

Tools for  -Crimp, see WK-APW 18, page 294.

■ PROCESSING INSTRUCTIONS FOR ALUMINIUM CABLE WITH ALUMINIUM AND ALUMINIUM/COPPER COMPRESSION CABLE LUGS AND PRESS CONNECTORS

Aluminium's material characteristics differ greatly from those of copper. Therefore, only use cable lugs and connectors made of aluminium or an aluminium/copper combination.

Cable lugs

Aluminium compression cable lugs

Material: Al 99.5, with pipe measurements pursuant to DIN 46329, insulated throughout the entire length pursuant to DIN 46239.

Optional: tin-plated thin layer, tin-plated thick layer.

Nominal cross section: 10 mm² - 500 mm² (custom-made products: up to 1000 mm²)

Aluminium/copper compression cable lugs

Material: Al 99.5 and Cu pursuant to DIN EN 13601; Surface: bare.

Nominal cross section: 10 mm² - 500 mm² (custom-made products: up to 1000 mm²).

To obtain the optimum fill factor, it is important that the conductor's diameter and the inner cable lug diameter are ideally matched to one another. Small gaps and ideal friction are important for destroying the non-conductive oxide coating.

The markings on DIN cable lugs contain information on:

- Manufacturer ID
- Tool reference number
- Metric screw measurement of the bore hole for the connection bolts
- Nominal cross section of the wire in mm²
- RE/SE = Single-wire round conductor/sector-shaped conductor
- RM/SM = Multi-wire round conductor/sector-shaped conductor

Example:

12-150RM/SM-185SE stands for:

12: Metric screw measurement of the bore hole for the connection bolts

150: Nominal cross section of the wire in mm²

RM/SM: Multi-wire round conductor and sector-shaped conductor

185: Nominal cross section of the wire in mm²

SE: Single-wire sector-shaped conductor

K25: Tool reference number

Press connector

Aluminium press connector

Material: Al 99.5 with pipe measurements pursuant to DIN 46267, Part 2; Surface: bare.

Nominal cross section: 10 mm² - 500 mm² (custom-made products: up to 1000 mm²).

Aluminium/copper press connectors

Material: Al 99.5 and Cu pursuant to DIN EN 13601; Surface: bare.

Nominal cross section: 10 mm² - 500 mm² (custom-made products: up to 1000 mm²).

A. Aluminium conductor crimping die categories:

RE = Single-wire round conductor

SE = Single-wire sector-shaped conductor

RM = Multi-wire round conductor

SM = Multi-wire sector-shaped conductor

In general, it is recommended to use standardised 6-corner crimping dies pursuant to DIN 48083, part 4.

To ensure proper grouting, make sure that the press tool insert that is used always matches the tool reference number on the cable lug or connector. The reference number is mirror inverted on the press surface of the insert to ensure that the reference number remains visible for monitoring and documentation purposes after grouting.

B. Aluminium conductor crimping die categories:

Fine-wire strand

(POWERLINE ALU Series)

The standard crimping technique is not recommended for a fine-wire aluminium conductor design. For the POWERLINE ALU series, we recommend our specially-developed C8 crimp that is tested according to IEC 61238-1 Cl. A. C8 crimp contours penetrate very deeply into the stranded bundle, equally tear up the individual strands, and make them conductive. With this process, the best values (low contact resistances) and mechanical extraction forces can be reached. The C8 crimp was also tested on multi-wire round conductors (RM).

■ PROCESSING INSTRUCTIONS FOR ALUMINIUM CABLE WITH ALUMINIUM AND ALUMINIUM/COPPER COMPRESSION CABLE LUGS AND PRESS CONNECTORS

Processing steps

for a secure and reliable connection

- 1) Dismantle the aluminium conductor
- 2) Remove the oxide coating from the conductor ends to create a clean contact surface. We recommend using a brass brush solely used for this purpose.
- 3) Immediately grease the conductor ends after removing the oxide coating to prevent re-oxidation.
- 4) Repeat steps 2) and 3) if the conductor can not be connected immediately.
- 5) Slide the entire cable lug/press connector insertion sleeve over the conductor. While doing so, the contact grease will ooze out from the sides, thereby creating an air-tight seal that prevents re-oxidation.
- 6) Perform C8 or 6-corner crimping, depending on the conductor.
- 7) The connector's side contact surface (current rail) should be treated as described in No. 2. Optional: Treat the contact surface with contact grease.
- 8) Tighten clamping point after approx. 200 operating hours.

Pressing procedure

Crimp the cable lug and/or connector using the assigned tools while taking into account the pressing direction. All DIN compression cable lugs have markings for proper crimping. Refer to the manufacturer's specifications for information on the number of markings (crimps). The correct pressing direction runs in the direction of the conductor, since the conductor material tends to slide out during crimping.

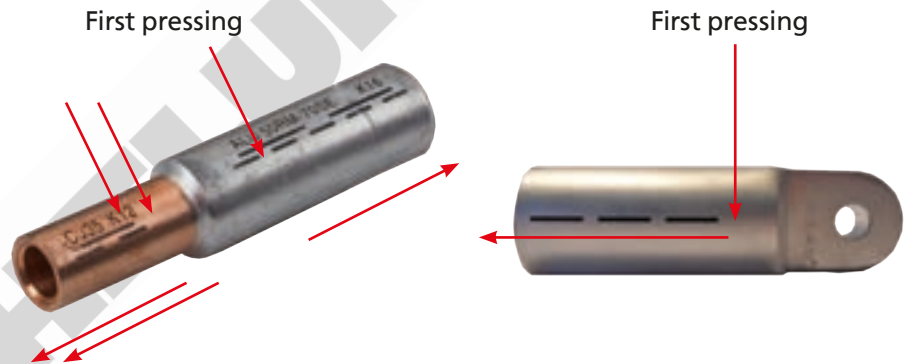

Insulation after crimping

To prevent corrosion and damage to aluminium conductors in compression cable lugs and/or press connectors, we generally recommend using insulated shrink tubes (warm/cold/rolling-shrink tubes). The shrink tubes used must match the application's dielectric strength. Furthermore, the shrink tube's wall thickness must be selected depending on the mechanical load during installation and operation. When vertically laying the cable or in areas with excessive condensation build-up, we recommend using a shrink tube with inside adhesive that prevents moisture from entering the crimped connection over the long run.

Examples:

- SK-D (thick-walled) under heavy load
- SK-M (medium-wall thickness)
- SK (thin-walled) under low mechanical load

■ GLOSSARY OF TERMS

Types	Page
B	
Bolt Cable Lug with Shear Head	278
Bolt Connector with Shear Head	279
C	
Cable clamps K	282
Cable clamps KS	282
Cable conduit with inner striations	254
Cable Fittings, Cable connection RSTI	286
Cable Fittings, Coupling plug RSTI-CC	286
Cable Fittings, MXSU Heat-shrink joint	287
Cable Fittings, SXSU Heat-shrink joint	287
Cable Fittings, UAGA Heat-shrink joint	287
Cable Fittings, VMDU Heat-shrink joint	287
Cable gland, HELUTOP® HT	255
Cable gland, HELUTOP® HT-E	255
Cable gland, HELUTOP® HT-MS	255
Cable gland, HELUTOP® MS-EP4	255
Cable grips with thimble and press clamp	254
Cable installation grips with side loop	254
CAN Bus fixed in talled 105°C, PVC, BUS Cables	234
Command Cable UL (LiYCY)	176
Command Cable UL (LiYCY-TP)	180
Command Cable UL (LiYY)	175
Command Cable UL (LiYY-TP)	178
D	
DATAFLAMM®	172
DATAFLAMM® -C	173
DATAFLAMM® -C-PAAR	174
F	
F-CY-JZ	114
FIVENORM	161
FLEV-S, outdoor termination, shrinking type	289
H	
H05Z-K / H07Z-K	159
H07RN-F	145
H07V-K / (H)07V-K	157
HELUCOM® pact, Fibre Optic Outdoor Cable, acc. DIN VDE 0888, A-DQ(ZN)B2Y, central	247
HELUCOM® WK, Fibre Optic Cable flexible, WK - UL/C A, A-V(ZN)YY	240
HELUCOM® WK, Fibre Optic Cable flexible, WK robust PUR + PVC (UL/CSA), AT-V(ZN)H(ZN)11Y, AT-V(ZN)Y(ZN)Y	238
HELUCOM®, Fibre Optic Breakout Cable robust, flexible, HCS UL/C A, I-V(ZN)YY	241
HELUCOM®, Fibre Optic Breakout Cable robust, flexible, HCS, I-V(ZN)Y11	242
HELUCOM®, Fibre Optic Cable flexible, WK - mobile, A-V(ZN)11	239
HELUCOM®, Fibre Optic Indoor/Outdoor Cable, acc. DIN VDE 0888, A/I-D Q(ZN)BH, central	246
HELUCOM®, Fibre Optic Outdoor Cable, acc. DIN VDE 0888, A-DQ(ZN)B2Y fibre combi, stranded	250
HELUCOM®, Fibre Optic Outdoor Cable, acc. DIN VDE 0888, A-DQ(ZN)B2Y, central	248
HELUCOM®, Fibre Optic Outdoor Cable, acc. DIN VDE 0888, A-DQ(ZN)B2Y, stranded	249
HELUCOM®, Plastic Fibre cable industry, POF/PE, I-V2Y, I-V2Y(ZN)11Y	245
HELUCOM®, Plastic Fibre Cable PROFIBUS, POF/PA, I-V4Y(ZN)Y	244
HELUCOM®, Plastic Fibre Cable PROFInet, POF/PA, I-V4Y(ZN)Y (type B), I-V4Y(ZN)11Y (type C)	243
HELUKAT® 100IND, WK Industrial 105°C, SF/UTP, Category 5e, Industrial Ethernet	232
HELUKAT® 100T, TORDIERFLEX, SF/UTP, Category 5, Industrial Ethernet	233
HELU-S-PAB-AL/CU-DIN, Bimetallic Compression Terminal Pin Type	274
HELU-S-PAB-AL-DIN, Aluminium Compression Terminal Pin Type	273

■ GLOSSARY OF TERMS

Types

Page

H

HELU-S-PK-AL/CU, Aluminium / Copper compression cable lug – straight	267
HELU-S-PK-AL-DIN, Tubular compression cable lugs	265
HELU-S-PK-AL-FG, compression cable lug, FG, extruded, straight ring design	266
HELU-S-PK-CU-DIN, Tubular compression cable lugs - straight	256
HELU-S-PV-AL/CU, Aluminium / Copper press connector	271
HELU-S-PV-AL-DIN, Aluminium press connector	270
HELU-S-RK-45-CU, Copper tubular cable lug - 45° angled	261
HELU-S-RK-45-CU-UL, Copper tubular cable lug - 45° angled	262
HELU-S-RK-90-CU-UL, Copper tubular cable lug - 90° angled	263
HELU-S-RK-CU, Copper tubular cable lug - straight	258
HELU-S-RK-CU-UL, Tubular cable lug - straight	259
HELUTHERM® 145	164
HELUTHERM® 145 MULTI	149
HELUTHERM® 145 MULTI-C	151
HELUTHERM® 145, 600 V	166
HELUTOOL HAP 60-2, Battery-powered hydraulic tool in toolbox	297
HELUWIND® WK (N)A2XH	72
HELUWIND® WK 101 H	46
HELUWIND® WK 103k EMV D-Torsion	36
HELUWIND® WK 103k-Torsion	34
HELUWIND® WK 103w EMV D-Torsion	32
HELUWIND® WK 103w-Torsion	30
HELUWIND® WK 110-Torsion	47
HELUWIND® WK 135 EMV D-Torsion	40
HELUWIND® WK 135-Torsion	38
HELUWIND® WK 137 EMV D-Torsion FT4	44
HELUWIND® WK 137-Torsion FT4	42
HELUWIND® WK 300w-Torsion	51
HELUWIND® WK 310-Torsion	52
HELUWIND® WK ALU Blade	74
HELUWIND® WK ALU Tower	73
HELUWIND® WK Brandmeldekabel-Torsion	49
HELUWIND® WK DLO, WK DLO-Torsion	50
HELUWIND® WK H07BN4-F WIND-Torsion	48
HELUWIND® WK Lift	110
HELUWIND® WK MS Multi-Torsion	56
HELUWIND® WK MS Multi-Torsion UL/CSA	57
HELUWIND® WK MS Single 610-Torsion	53
HELUWIND® WK MS Single-Torsion	54
HELUWIND® WK MS Single-Torsion UL/CSA	55
HELUWIND® WK POWERLINE ALU 0,6/1 kV	75
HELUWIND® WK POWERLINE ALU 1,8/3 kV	77
HELUWIND® WK POWERLINE ALU halogen-free	79
HELUWIND® WK POWERLINE ALU MS SINGLE	100
HELUWIND® WK POWERLINE ALU MULTI	148
HELUWIND® WK POWERLINE ALU robust 0,6/1 kV	76
HELUWIND® WK POWERLINE ALU robust 1,8/3 kV	78
HELUWIND® WK POWERLINE ALU SINGLE	156
HELUWIND® WK RHH/RHW-2 ALU	80
HELUWIND® WK THERMFLEX® 145	60
HELUWIND® WK-Multiclamp	283
HYDAC - Fastening systems in the turret	281
I	
IREV-S, indoor termination, shrinking type	288

■ GLOSSARY OF TERMS

Types	Page
J	
JZ-500	111
JZ-500 COLD	113
JZ-500 HMH	118
JZ-500 HMH-C	120
JZ-600	126
JZ-600 HMH	130
JZ-600 HMH-C	132
JZ-600 UL/CSA	134
JZ-600-Y-CY	128
JZ-600-Y-CY UL/CSA	136
JZ-602	138
JZ-602-CY	140
JZ-603	142
JZ-603-CY	143
JZ-604 TC TRAY CABLE	205
JZ-604-YCY TC TRAY CABLE	207
K	
KAC-U, AL/CU-bi-met allic washer	269
M	
Machine outlet IP65, Industrial Ethernet, SC MM, IP65	229
Machine outlet IP67, Industrial Ethernet, SC MM, IP67	228
Mechanical Split Connector with Shear Head	280
Medium-Voltage Cable Accessories, INLINE Junction Box up to 42 kV	291
MEGAFLEX® 500	122
MEGAFLEX® 500-C	124
MULTIFLEX 600	213
MULTIFLEX 600-C	214
MV-90 / MV-105 ALUMINIUM /COPPER	101
N	
N2XH	61
N2XS(F)2Y 6/10 kV, 12/20 kV, 18/30 kV	88
N2XS(FL)2Y 6/10 kV, 12/20 kV, 18/30 kV	90
N2XS2Y 6/10 kV, 12/20 kV, 18/30 kV	86
N2XSY 6/10 kV, 12/20 kV, 18/30 kV	84
NA2XS(F)2Y 6/10 kV, 12/20 kV, 18/30 kV	96
NA2XS(FL)2Y 6/10 kV, 12/20 kV, 18/30 kV	98
NA2XS2Y 6/10 kV, 12/20 kV, 18/30 kV	94
NA2XSY 6/10 kV, 12/20 kV, 18/30 kV	92
NA2XY	71
NAY2Y	70
NAYY	68
P	
PAAR-TRONIC-CY	170
Profibus L2 Torsion + Festoon, PUR+PVC, BUS Cables	236
Profibus SK fixed installed FRNC + Robust, FRNC+PUR, BUS Cables	237
Profibus SK fixed installed Indoor + Outdoor, PVC + PE, BUS Cables	235
PROFInet Type B flexible, PUR, Industrial Ethernet	230
PROFInet Type C Torsion, PUR, Industrial Ethernet	231

■ GLOSSARY OF TERMS

Types	Page
R	
Repair Sleeves for shielded single-conductor plastic cable	290
Rollover Insulation Hose	293
Roxtec Sealing Solution	284
S	
Single 600-CY-J / -O	64
Single 600-J / -O	63
SK-D, heat shrink 3:1 - with interior adhesive	292
SOOW	147
SUPER-PAAR-TRONIC 340-C-PUR	187
SUPER-PAAR-TRONIC-C-PUR®	186
SUPERTRONIC® -330 C-PURö	185
SUPERTRONIC® -330 PURö	184
SUPERTRONIC® -C-PURö	183
SUPERTRONIC® -PURö	182
T	
THHN / THWN	167
TOPFLEX® 600 VFD	215
TOPFLEX® 650 VFD	216
TRAYCONTROL 610 OIL RES II	211
TRAYCONTROL® 300	193
TRAYCONTROL® 300 TP	197
TRAYCONTROL® 300-C	195
TRAYCONTROL® 300-C TP	199
TRAYCONTROL® 500	201
TRAYCONTROL® 500-C	203
TRAYCONTROL® 600	208
TRAYCONTROL® 600-C	210
W	
WK-APW 18, Battery-operated compression tool	294
WK-Electro hydraulic pump with battery	295
WK-Electro-hydraulic radial-piston-pump (230V) with transport cart	296
WK-SC-P Shear Bolt Connector	275
WK-SC-T Shear Bolt Connector	276
WK-SL-T Shear Bolt Cable Lug	277
Y	
Y-CY-JZ	116

■ PART NO. INDEX

Part No.	Page	Part No.	Page
10001 - 10549	111	33275 - 34046	69
10550 - 10746	126	34090 - 34127	145
10750 - 10797	113	34312 - 34315	90
10881 - 10904	63	34349 - 37154	145
10910 - 10933	64	38049 - 38061	90
11201 - 11341	118	38062 - 38091	98
11342 - 11350	120	38548 - 38565	147
11464 - 11629	128	49583 - 49615	182
11656 - 11813	120	49653 - 49685	183
11815 - 11941	134	49764 - 49796	184
12345 - 12405	136	49797 - 49829	185
12410 - 12470	137	49830 - 49870	187
12723 - 12804	130	50899	160
12850 - 12907	132	50998 - 50999	164
13137	128	51000	151
13139 - 13140	111	51070 - 51391	164
13147	128	51392 - 51418	160
13344 - 13489	122	51419 - 51558	164
13500 - 13597	124	51768 - 51902	159
16157 - 16318	116	52135 - 52154	160
16320 - 16452	114	52194 - 52292	151
16453 - 16468	116	52300 - 52361	172
16490 - 16493	114	52365 - 52429	173
17001 - 17056	170	52430 - 52431	172
17172	116	52435 - 52484	174
19101 - 19141	186	52485 - 52486	61
19970 - 21064	170	52630 - 52644	149
26060 - 26119	158	52809 - 52868	160
26395 - 26398	157	52872 - 53088	159
26399 - 28891	158	53100 - 53336	61
29129 - 29192	157	53376 - 53549	149
29193 - 29933	158	53557 - 53559	61
31129 - 31209	70	59378 - 59379	205
31219	96	59472 - 59653	166
32177 - 32399	68	59760 - 59836	199
32400 - 32437	84	61928 - 61998	197
32440 - 32478	92	61999	199
32480 - 32517	86	62020 - 62028	208
32520 - 32555	94	62502 - 62554	213
32560 - 32591	88	62556 - 62605	214
32600 - 32630	96	62625 - 62709	193
32999	94	62710 - 62793	195
33054 - 33075	90	62794 - 62800	197
33078	94	62802 - 62812	201
33083	90	62813 - 62875	203
33084 - 33089	98	62876 - 62884	216
33090 - 33091	96	62902 - 62996	208
33092	88	62997 - 63078	210
33096	84	63079 - 63133	201
33097	96	63136	213
33098 - 33099	84	63137	215
33113 - 33156	71	63138	216

■ PART NO. INDEX

Part No.	Page	Part No.	Page
63139 - 63155	215	80629 - 80630	245
63156 - 63163	216	80681 - 80851	246
63164 - 63199	201	81036 - 81038	239
63331	167	81108 - 81382	249
63332 - 63334	162	81501	237
63335 - 63340	163	81611 - 81882	245
63341	167	81903 - 81904	235
63342 - 63348	163	81905	237
63351	167	82032 - 82033	245
63352 - 63354	162	82431	246
63355 - 63360	163	82488	140
63361	167	82648	249
63362 - 63368	163	82780 - 83000	140
63371	167	83001 - 83044	138
63372 - 63374	162	83045 - 83050	175
63375 - 63380	163	83051 - 83054	138
63381	167	83055 - 83059	175
63382 - 63388	163	83060 - 83104	138
63391 - 63401	167	83130 - 83227	175
63402 - 63416	162	83254 - 83344	176
63417 - 63497	163	83371 - 83498	175
64075 - 64122	161	83565	138
64123 - 64330	162	83650 - 83708	142
65044 - 65087	176	83709 - 83773	143
65214 - 65285	178	83774 - 83845	180
65314 - 65385	180	83904 - 83975	178
65386 - 65388	162	83976 - 83997	176
65389 - 65401	163	93190 - 93200	288
65402 - 65562	161	93360 - 93380	289
69625 - 69627	162	94420 - 94425	288
69628 - 69660	163	94426 - 94430	289
69661 - 69737	205	702485	49
69738 - 69741	163	702513 - 702863	50
69804 - 69826	207	703041 - 703152	33
69827 - 69907	162	703156 - 703171	50
71437	60	703285 - 703288	40
74006	37	703289	38
75486 - 75496	60	703290	40
78177 - 78180	37	703291 - 703316	38
79954	88	703317 - 703323	39
80180 - 80187	248	703328	37
80188 - 80195	249	703390 - 703404	48
80196 - 80204	248	703668 - 703671	38
80207 - 80211	249	703672	40
80212 - 80218	248	703673	38
80219	249	703674 - 703702	40
80220	248	703703 - 703804	41
80223 - 80227	249	703862	50
80264 - 80281	246	703920 - 703933	30
80363 - 80382	239	704038 - 704039	40
80388 - 80532	245	704040	41
80534	239	704167	40

■ PART NO. INDEX

Part No.	Page	Part No.	Page
704267	30	704900	36
704268	32	704901 - 704902	37
704269	30	704903 - 704904	36
704287 - 704295	31	704905	37
704366 - 704368	30	704906	36
704369	32	704907	37
704471	38	704908 - 704909	36
704675 - 704684	41	704910 - 704913	37
704685	40	704914 - 704915	36
704686 - 704696	41	704916	36
704697 - 704698	40	704917	37
704699 - 704740	38	704918	36
704741	39	704919	37
704742 - 704744	38	704920	36
704745	39	704921	37
704749 - 704751	33	704922 - 704938	36
704752	32	704939	37
704753 - 704754	33	704940 - 705014	34
704755	32	705015	35
704756 - 704757	33	705016 - 705018	34
704758	32	705019 - 705026	35
704759 - 704761	33	705031 - 705034	72
704762 - 704765	32	705037	36
704766 - 704767	32	705038	34
704768 - 704769	32	705039	32
704770	33	705040	30
704771	32	705045	40
704772 - 704773	33	705046 - 705108	38
704774 - 704775	32	705228	32
704776 - 704777	33	705719 - 705759	42
704778 - 704779	32	705822	32
704780 - 704783	33	705829	33
704784 - 704786	32	706084 - 706089	75
704787	33	706194 - 706287	211
704788	32	706318	30
704789	33	706337	31
704790	32	706399 - 706407	51
704791	33	706408	75
704792 - 704808	32	706432	51
704809 - 704873	30	706452 - 706460	52
704874 - 704876	31	706461 - 706501	44
704877 - 704879	37	706503 - 706530	45
704880	36	706557 - 706558	60
704881 - 704882	37	706576 - 706577	74
704883	36	706578	77
704884 - 704885	37	706599	32
704886	36	706601	33
704887 - 704889	37	707006	40
704890 - 704893	36	707062 - 707064	75
704894	37	707097 - 707104	76
704895 - 704898	36	707129	39
704899	37	707432	77

■ PART NO. INDEX

Part No.	Page	Part No.	Page
707454 - 707464	39	802792	240
707494 - 707531	46	803037 - 803038	250
707638	41	803346 - 803349	238
707647 - 707648	77	803923 - 803924	250
707651	38	803934 - 803935	240
707692 - 707695	78	804700	238
708425 - 708428	56	805686 - 805838	243
708436	39	905335 - 905732	292
708470 - 708474	73	906049 - 906053	269
708487	88	906172 - 906185	267
708687	39	906207	295
708702 - 708710	55	906209 - 906210	271
708712 - 708716	54	906212	267
708717 - 708725	55	906406	270
708726 - 708733	56	906436 - 906459	265
708734 - 708745	57	906460	271
708746 - 708754	80	906461 - 906477	265
708857	50	906478 - 906494	267
708974 - 708984	43	906495 - 906510	271
709143 - 709146	79	906511 - 906521	270
709288 - 709735	50	906524 - 906538	256
709855 - 709867	47	906647	294
709914 - 709921	156	906721	296
709957	73	907303 - 907317	258
710226	30	907318 - 907407	259
710278	110	907467 - 907477	262
710435 - 710760	47	907478	261
711083 - 711087	148	907479 - 907487	262
712184 - 712210	100	907488	261
712222 - 712228	80	907489 - 907492	262
712374	72	907493	261
712561	30	907494 - 907496	262
712574	51	907497	261
712575	53	907498 - 907504	262
712576 - 712577	53	907505 - 907507	261
712585 - 712588	110	907508 - 907567	263
712589	72	907568 - 907596	267
712767 - 712768	110	907597 - 907599	262
800067	233	907600	261
800109 - 800649	236	907601	262
800654	230	907677 - 907749	256
800754 - 800762	247	907835	270
800980	242	907836 - 907862	271
801280	244	907865 - 907884	265
801354	228	908301 - 908310	273
801421	229	908494	297
801727	239	06320x - 06332x	167
801733	241		
801982	234		
802131 - 802142	247		
802186	231		
802293	232		

NOTES

Technical modifications

© HELUKABEL® GmbH Hemmingen

Specifications have been carefully checked and are believed to be correct; however, no responsibility is assumed for inaccuracies. Subject to technical modifications. Consequently all illustrations, numerical data, etc. are provided without guarantee. Color deviations between photos and delivered goods cannot be avoided. Reproduction or duplication of the text and illustrations, in whole or in part, remain reserved. The transfer of copyrights always requires the written consent of HELUKABEL® GmbH. Our General Terms of Delivery and Payment, which can be viewed at www.helukabel.com, apply.

Length markings

The length marking, which cannot be calibrated, is an aid, e.g. for easy material allowance determination or for determination of the length remaining on the drum. Deviation of the line length shown by the marking is up to 1%. Incomplete length markings or length markings missing on sections, deviations of the cable length shown by the length marking do not substantiate any legal obligation whatsoever. Only use calibrated measurement devices to determine line length.

Safety notice

The cables and wires described in the catalog are produced in accordance with national and international standards, as well as plant standards; application safety, as stipulated in the safety directives, standards, and statutory regulations, as amended, is provided. With the prerequisite of proper and professional installation and use, the possibility of product-specific dangers can be excluded. For each product this catalog describes general information for use. Independent of the above, the applicable DIN VDE specifications apply. However, installation and processing must only be executed by qualified electricians.

VDE approval

„Extracts from DIN standards with VDE classification are reproduced for the registered limited press run via permit no. 42.015 issued by Deutsches Institut für Normung e.V. [German Institute for Standardization] and VDE Verband der Elektrotechnik Elektronik Informationstechnik e.V. [Institute of Electrical and Electronics Engineers]. Any further reproduction or printing of these materials is subject to a specific permit. The versions of the standards with the most recent issue data are binding for the application thereof. These versions can be obtained from VDE VERLAG GMBH, Bismarckstr. 33, 10625 Berlin, www.vde-verlag.de and Beuth Verlag GmbH, 10772 Berlin.“

Our General Terms of Delivery and Payment, which can be viewed at www.helukabel.com, apply



HELUKABEL®

