

Akım Metal®





METİN AKIN METAL SAN. v e TİC. LTD. ŞTİ.

Firma sahibi olarak yol yardım ve bakım onarım araçları , izolasyon ve raflama sistemleri konusunda 15 yıl yurtdışında fiilen çalışarak elde etmiş olduğu tecrübelerle 1996 yılında Akın Metal San. ve Tic. Ltd. Şti. olarak faaliyete başlamış, 2008 yılından sonra Metin AKIN metal San.ve Tic. Ltd. Şti. Araç içi donanımları, Çalışma tezgahları, Malzeme dolapları, Takım arabaları ve Özel imalatlar konusunda faaliyet göstermektedir.

10.000 m² çalışma alanı , profesyonel kadrosu ve 800 m² satış mağazasıyla sizlere hizmet vermektedir. Faaliyet alanları yol yardım bakım ve onarım araçları, otomobil servisleri, fabrikalar, tersaneler , hava limanları , üniversiteler ve daha bir çok sektöre hitap etmektedir. Konusunda yeteri kadar deneyime sahip olan firma sahibi ve profesyonel kadrosuyla Türkiye'nin her yerine ve yurtdışına üretim yapmaktadır. Standart ve özel imalat projelendirme, geniş ürün yelpazesi, bol seçenek, üretimde kalite, sınırsız tasarım, renk seçenekleri ve ürünlerinin arkasında durabilen bir firma olmaktan gurur duymaktayız.



Profil Çalışma Tezgahı A-10.104



Profil Çalışma Tezgahı A-10.108



Profil Çalışma Tezgahı A-10.110

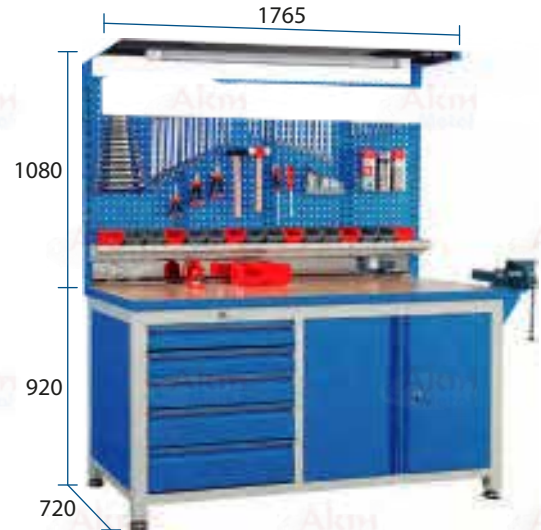

Profil Çalışma Tezgahı A-10.112



Profil Çalışma Tezgahı A-10.116

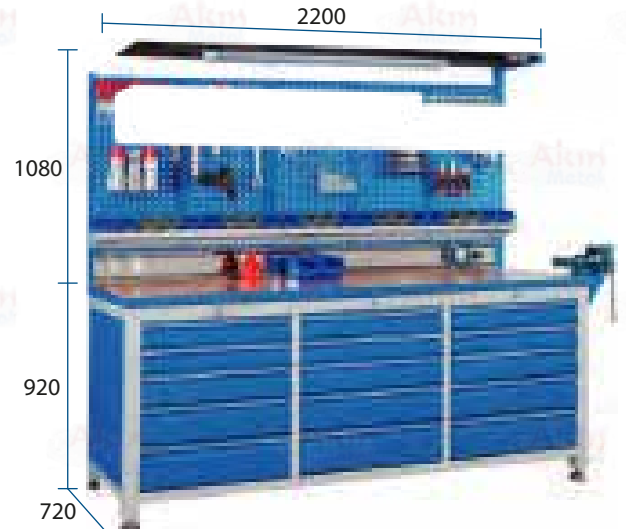

Profil Çalışma Tezgahı A-10.202



Profil Çalışma Tezgahı A-10.204



*Takım arabası opsiyoneldir.

Profil Çalışma Tezgahı A-10.206



*Takım arabası opsiyoneldir.

Profil Çalışma Tezgahı A-10.208



Profil Çalışma Tezgahı A-10.214



Profil Çalışma Tezgahı A-10.216



Profil Çalışma Tezgahı A-10.272

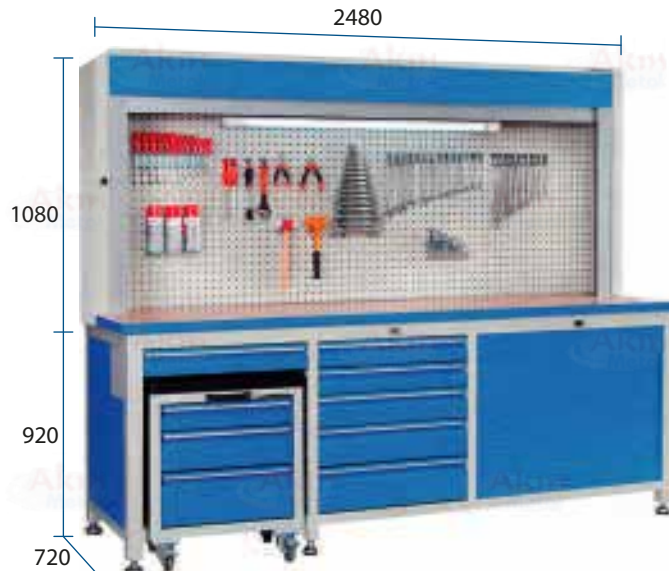

*Takım arabası opsiyoneldir.

*Ürünler üzerindeki hırdavat malzemeleri aksesuar amaçlıdır. Fiyatlara dahil değildir.

Profil Çalışma Tezgahı A-15.502



Profil Çalışma Tezgahı A-15.510

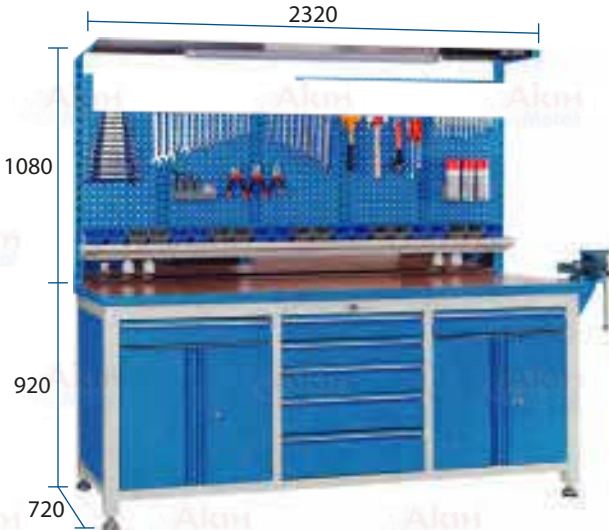

Profil Çalışma Tezgahı A-15.512



Profil Çalışma Tezgahı A-15.514



Profil Çalışma Tezgahı A-15.522



Profil Çalışma Tezgahı A-15.524



Profil Çalışma Tezgahı A-15.540



Profil Çalışma Tezgahı A-15.552



Profil Çalışma Tezgahı A-15.560



Profil Çalışma Tezgahı A-15.602

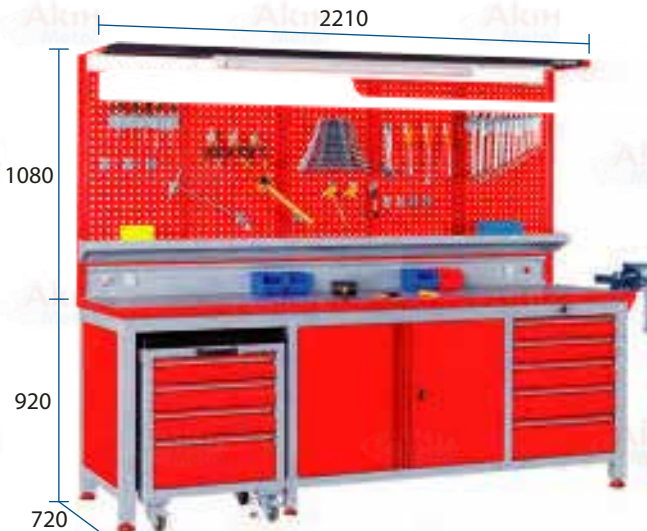

Profil Çalışma Tezgahı A-15.604



Profil Çalışma Tezgahı A-15.610

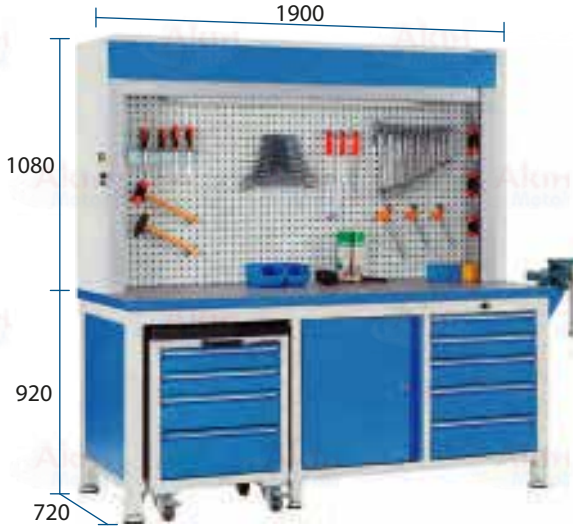

Profil Çalışma Tezgahı A-15.702



Profil Çalışma Tezgahı A-15.706



Profil Çalışma Tezgahı A-15.708



Profil Çalışma Tezgahı A-15.752

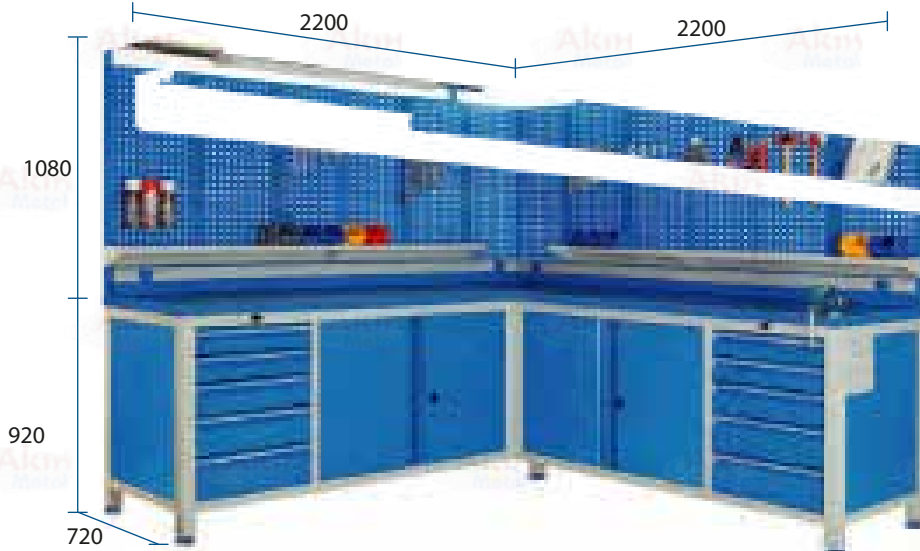

Profil Çalışma Tezgahı A-15.754

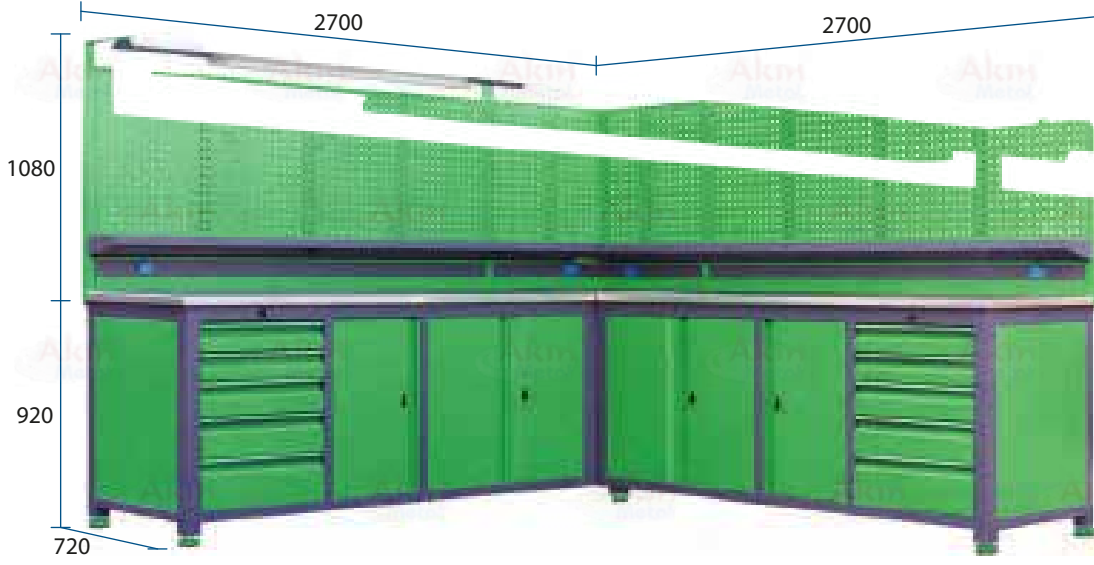

Profil Çalışma Tezgahı A-15.756



Profil Çalışma Tezgahı A-15.758

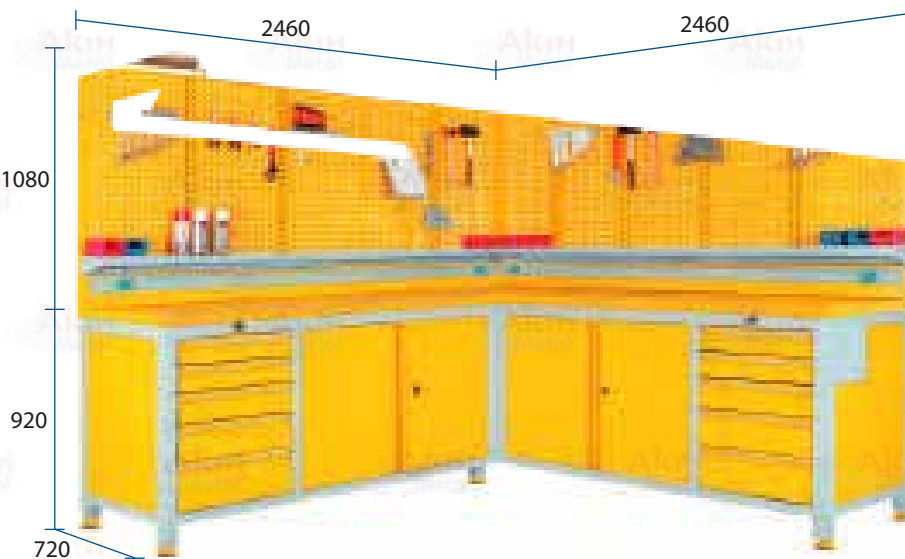

Profil Çalışma Tezgahı A-15.760



Profil Çalışma Tezgahı A-15.762



Profil Çalışma Tezgahı A-15.764



Profil Çalışma Tezgahı A-15.802



Profil Çalışma Tezgahı A-15.804



Profil Çalışma Tezgahı A-15.806



Profil Çalışma Tezgahı A-15.808



Profil Çalışma Tezgahı A-15.850



Profil Çalışma Tezgahı A-15.852

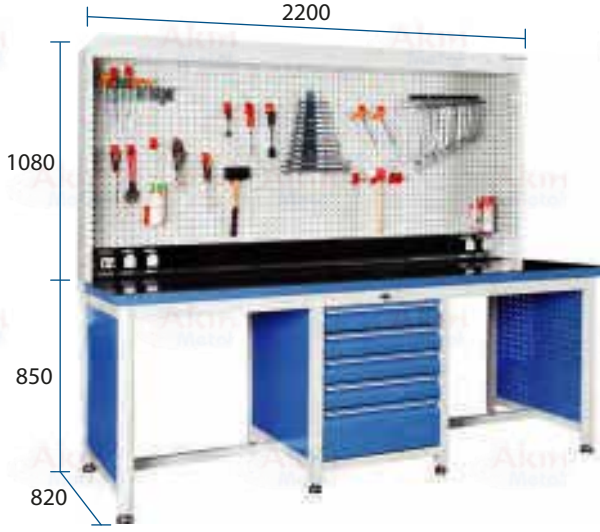

Profil Çalışma Tezgahı A-15.854

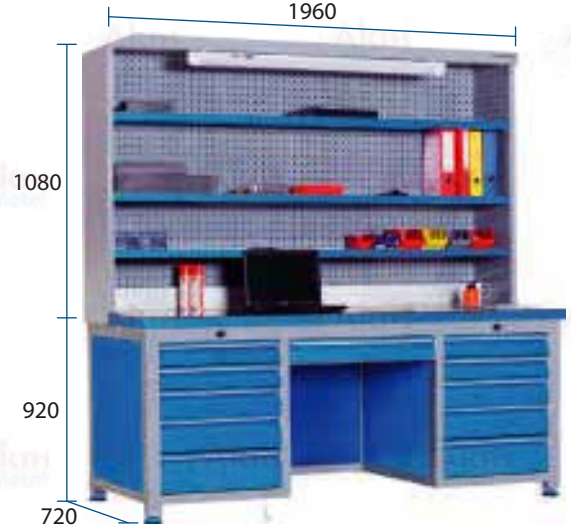

Profil Çalışma Tezgahı A-15.856

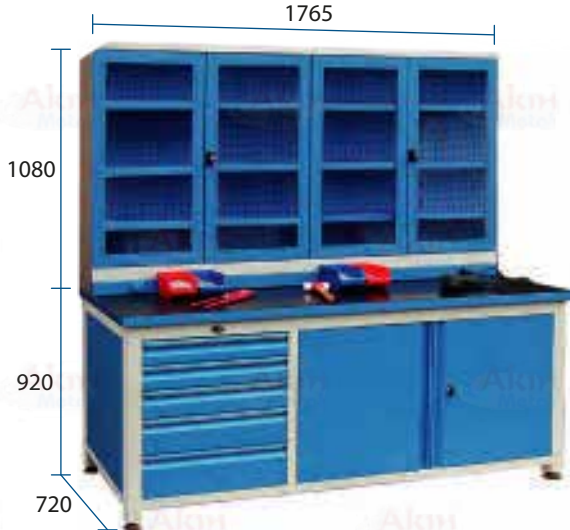

Profil Çalışma Tezgahı A-15.858



Profil Çalışma Tezgahı A-15.860

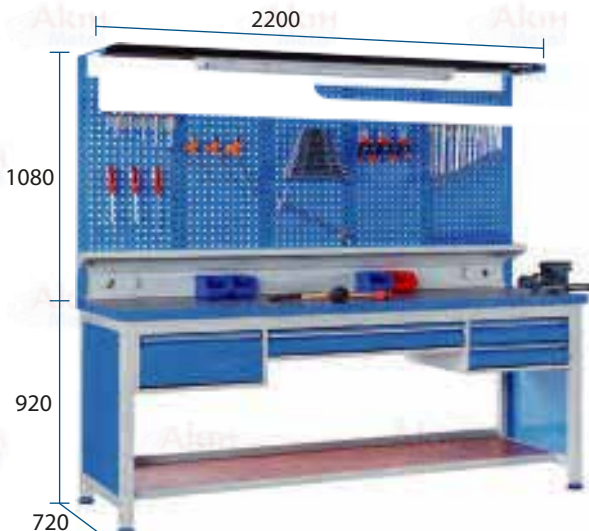

Profil Çalışma Tezgahı A-15.862

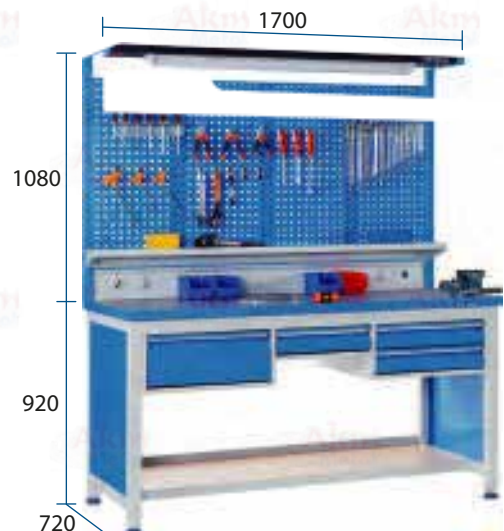

Profil Çalışma Tezgahı A-15.864

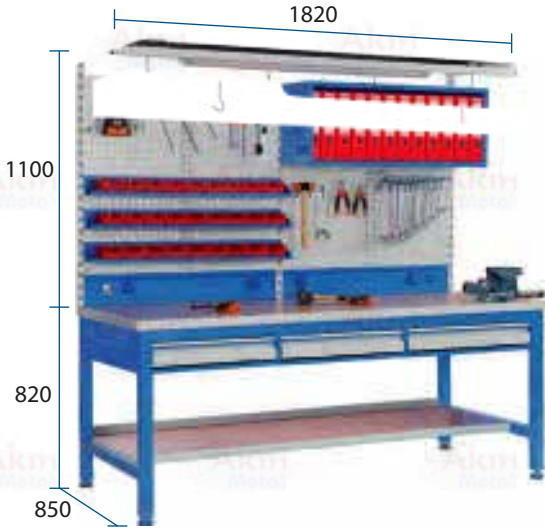

Profil Çalışma Tezgahı A-15.866

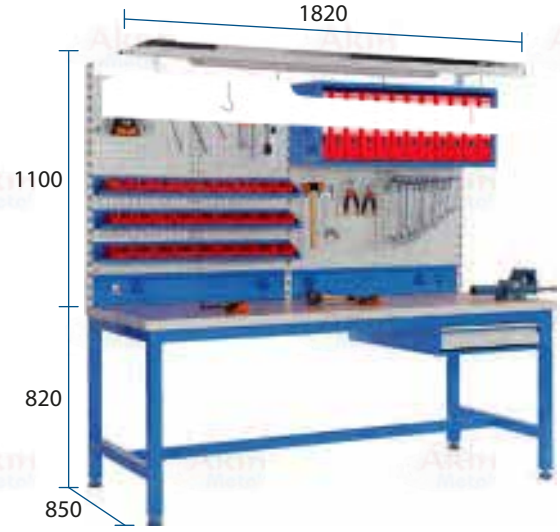

Profil Çalışma Tezgahı A-15.868

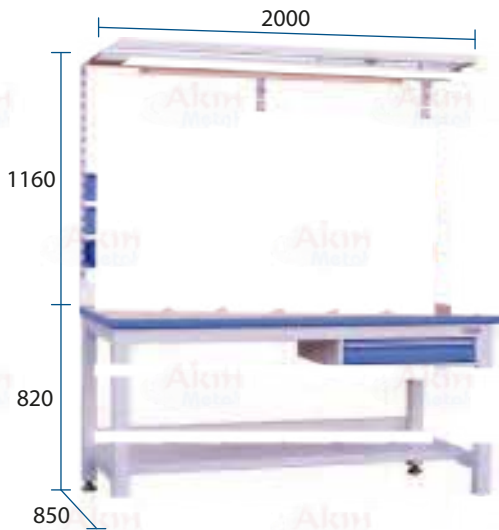

Profil Çalışma Tezgahı A-15.936



Profil Çalışma Tezgahı A-17.102



Profil Çalışma Tezgahı A-17.104



Profil Çalışma Tezgahı A-15.202



Profil Çalışma Tezgahı A-15.204



Profil Çalışma Tezgahı A-15.206



Profil Çalışma Tezgahı A-15.208



Profil Çalışma Tezgahı A-15.210



Profil Çalışma Tezgahı A-15.212



Profil Çalışma Tezgahı A-15.216



Profil Çalışma Tezgahı A-15.218

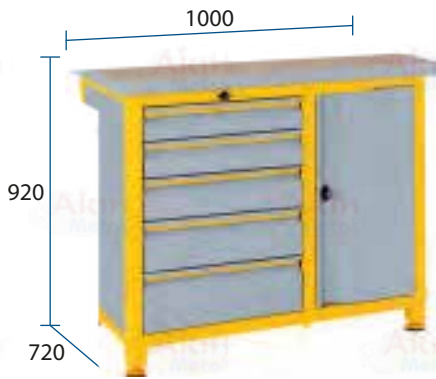

Profil Çalışma Tezgahı A-15.222



Profil Çalışma Tezgahı A-15.226

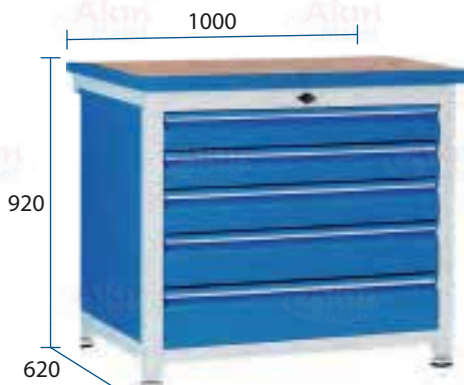

Profil Çalışma Tezgahı A-15.228

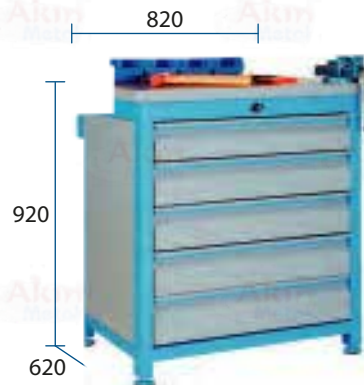

Modüler Çalışma Tezgahı B-20.102



Modüler Çalışma Tezgahı B-20.104



Modüler Çalışma Tezgahı B-20.106



Modüler Çalışma Tezgahı B-20.108

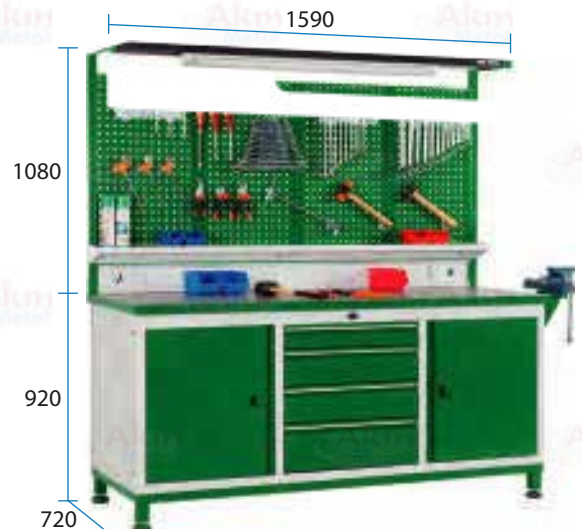

Modüler Çalışma Tezgahı B-20.110



Modüler Çalışma Tezgahı B-20.112

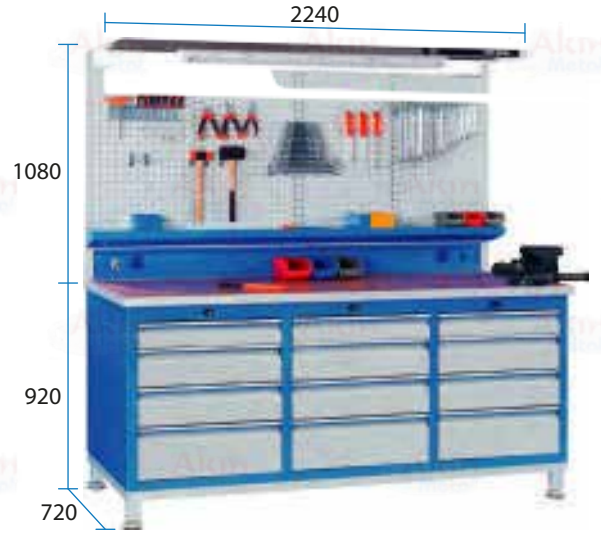

Modüler Çalışma Tezgahı B-20.114

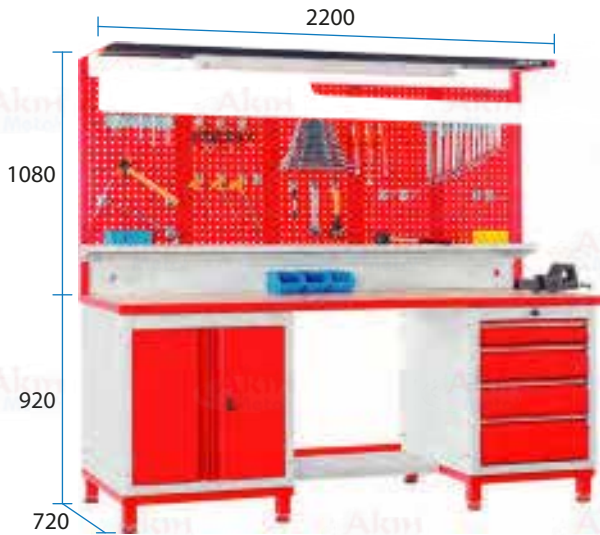

Modüler Çalışma Tezgahı B-20.116

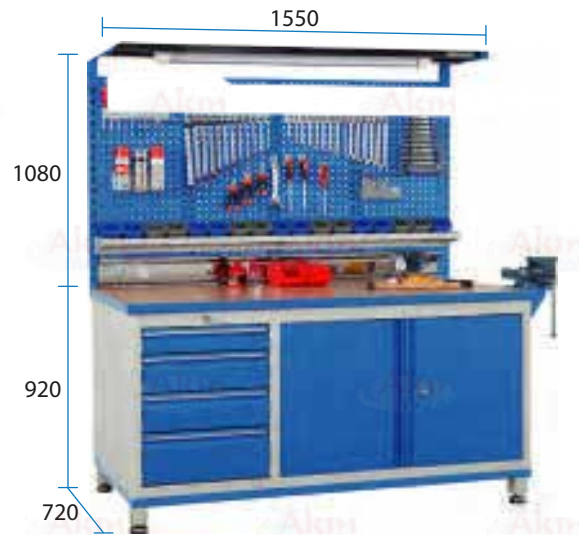

Modüler Çalışma Tezgahı B-20.120



Modüler Çalışma Tezgahı B-20.122

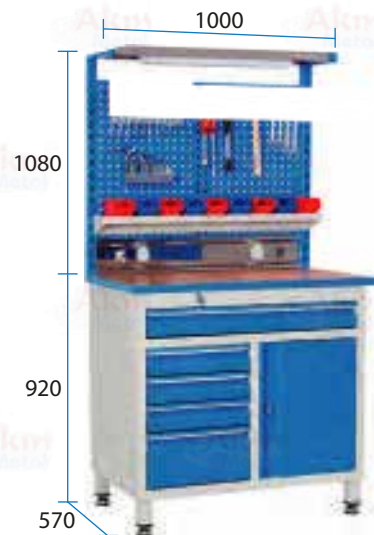

Modüler Çalışma Tezgahı B-20.124



Modüler Çalışma Tezgahı B-20.126



Modüler Çalışma Tezgahı B-20.128



Modüler Çalışma Tezgahı B-20.130

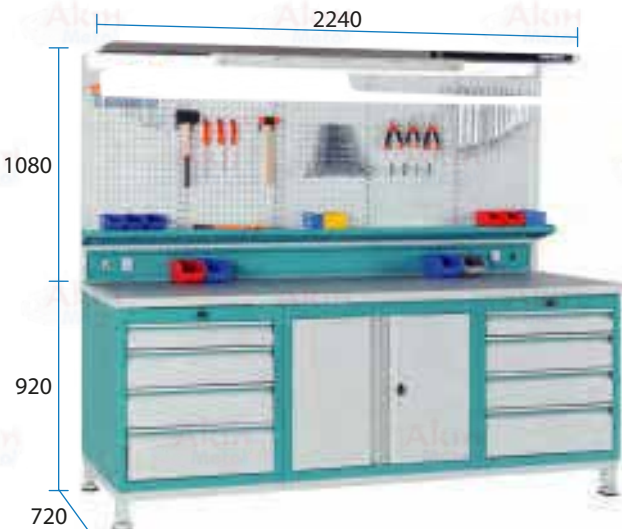

Modüler Çalışma Tezgahı B-20.132

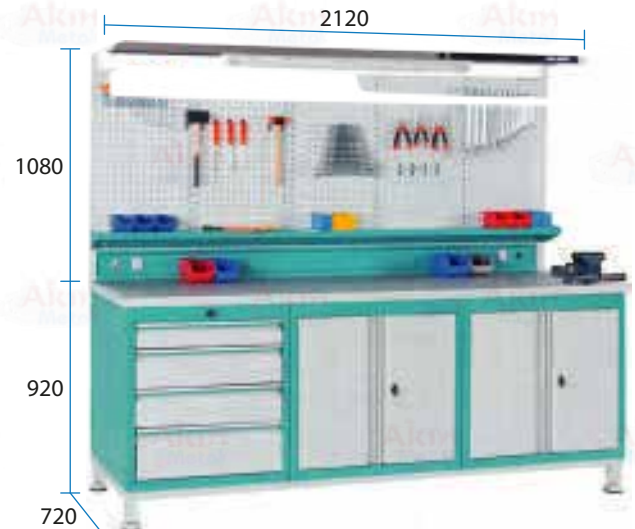

Modüler Çalışma Tezgahı B-20.134

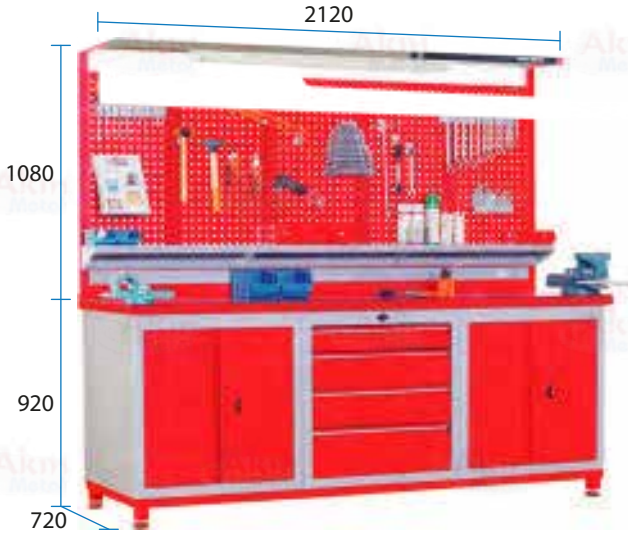

Modüler Çalışma Tezgahı B-20.136



Modüler Çalışma Tezgahı B-20.140



Modüler Çalışma Tezgahı B-20.148

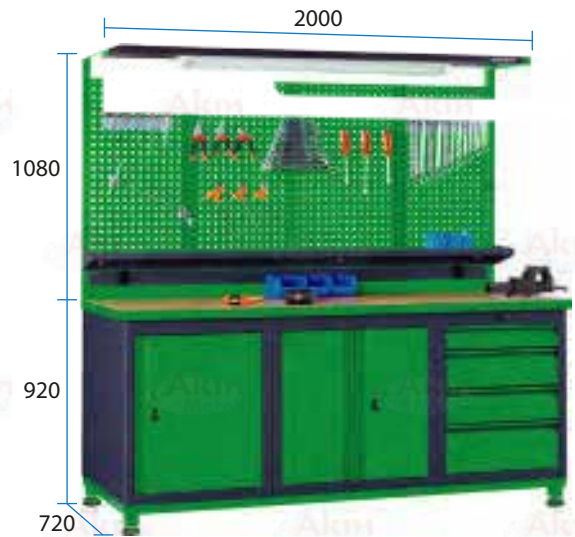

Modüler Çalışma Tezgahı B-20.152

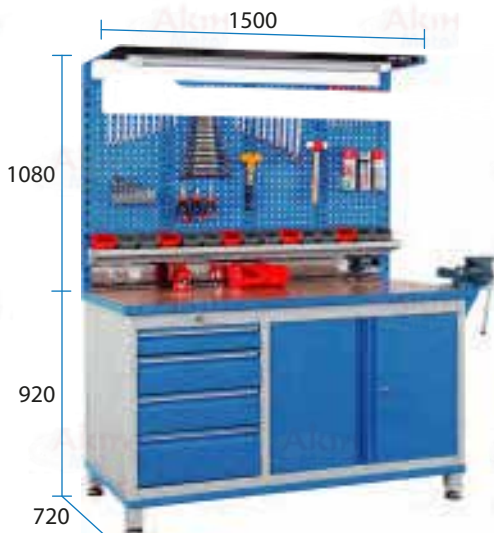

Modüler Çalışma Tezgahı B-20.156



Modüler Çalışma Tezgahı B-20.158



Modüler Çalışma Tezgahı B-20.160



Modüler Çalışma Tezgahı B-20.176

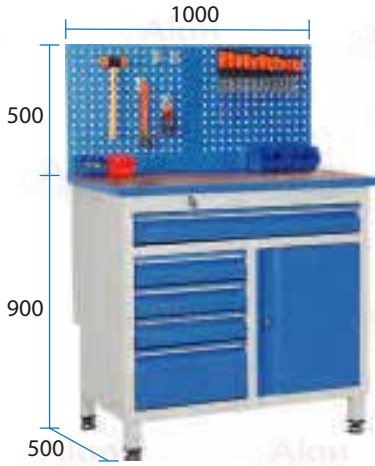

Modüler Çalışma Tezgahı B-20.178

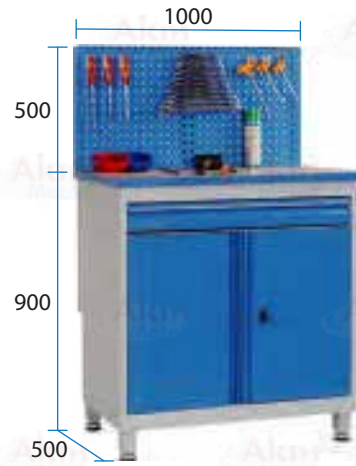

Modüler Çalışma Tezgahı B-20.186



Modüler Çalışma Tezgahı B-20.188



Modüler Çalışma Tezgahı B-20.190

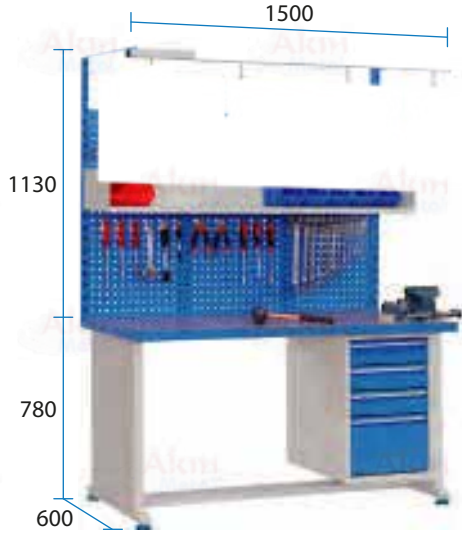

Modüler Çalışma Tezgahı B-20.192



Modüler Çalışma Tezgahı B-20.200



Modüler Çalışma Tezgahı B-20.206



Modüler Çalışma Tezgahı B-22.102

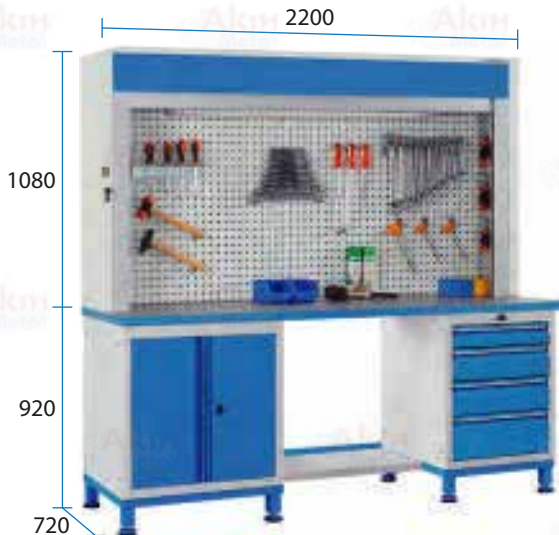

Modüler Çalışma Tezgahı B-23.102



Modüler Çalışma Tezgahı B-20.180



Modüler Çalışma Tezgahı B-20.182



Modüler Çalışma Tezgahı B-20.184



Modüler Çalışma Tezgahı B-20.194



Modüler Çalışma Tezgahı B-20.198



Modüler Çalışma Tezgahı B-20.202



Modüler Çalışma Tezgahı B-20.204



Modüler Çalışma Tezgahı B-21.102

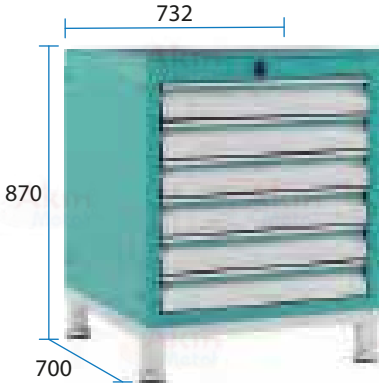

Modüler Çalışma Tezgahı B-21.104

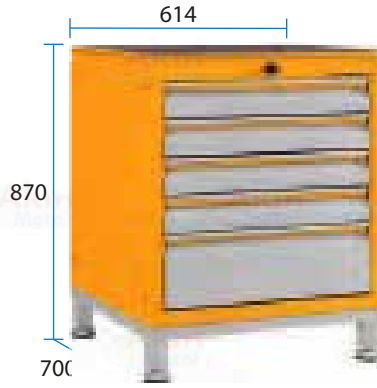

Modüler Çalışma Tezgahı B-21.108

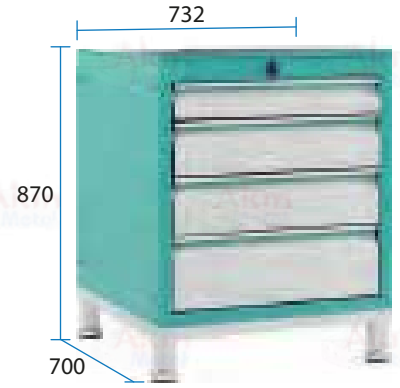

Modüler Çalışma Tezgahı B-21.110

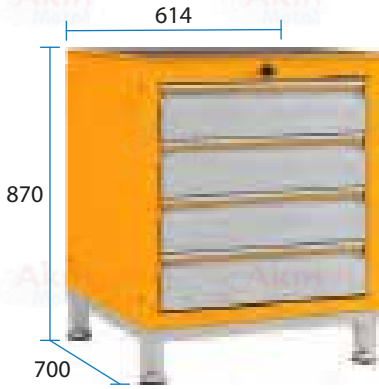

Modüler Çalışma Tezgahı B-21.112

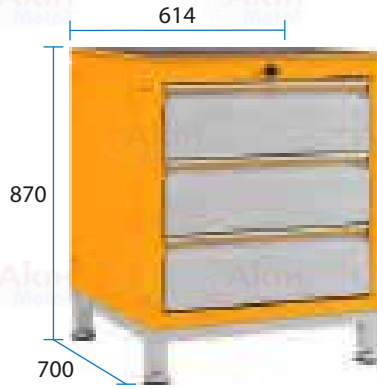

Modüler Çalışma Tezgahı B-21.114

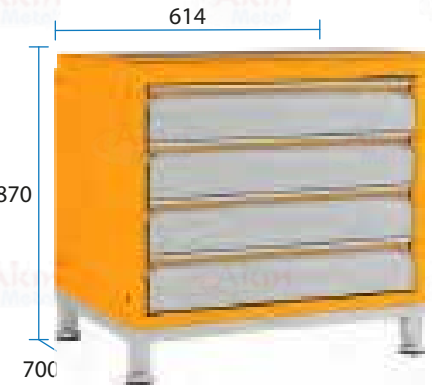

Modüler Çalışma Tezgahı B-21.202

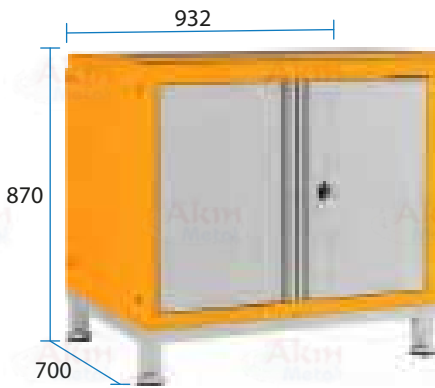

Modüler Çalışma Tezgahı B-21.206

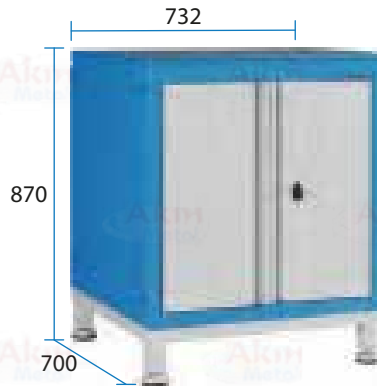

Modüler Çalışma Tezgahı B-21.208



Modüler Çalışma Tezgahı B-21.210

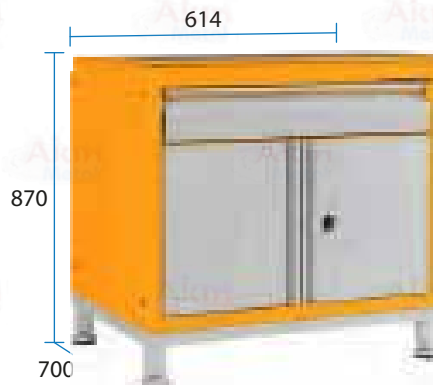

Demonte Çalışma Tezgahı C-25.102

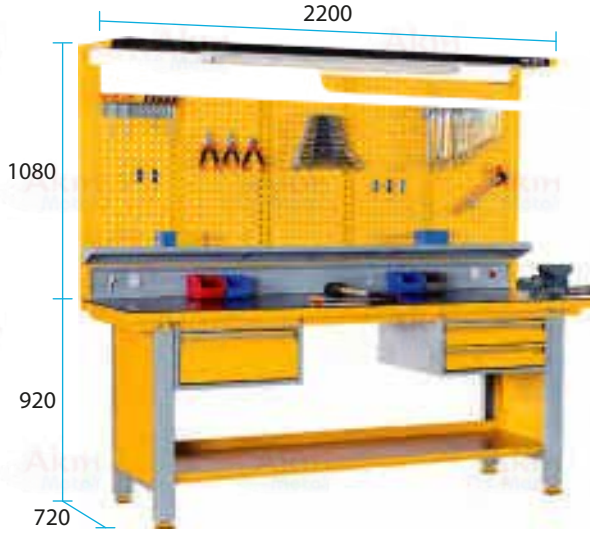

Demonte Çalışma Tezgahı C-25.106

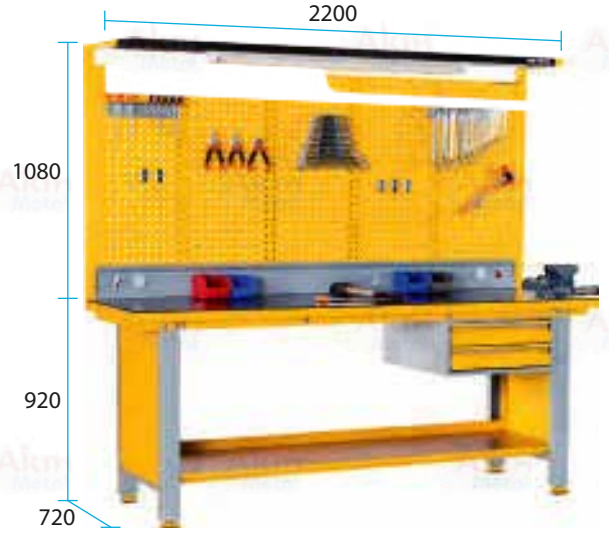

Demonte Çalışma Tezgahı C-25.112



Demonte Çalışma Tezgahı C-25.302



Demonte Çalışma Tezgahı C-25.304



Demonte Çalışma Tezgahı C-25.306



DEMONTE ÇALIŞMA TEZGAHLARI

DISASSEMBLED WORK BENCHES

Demonte Çalışma Tezgahı C-25.308



Demonte Çalışma Tezgahı C-25.310



Demonte Çalışma Tezgahı C-25.312



Demonte Çalışma Tezgahı C-25.402



Demonte Çalışma Tezgahı C-25.404



Demonte Çalışma Tezgahı C-25.406

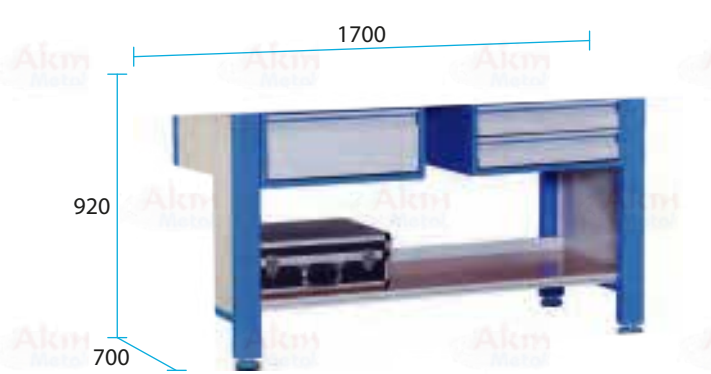

Demonte Çalışma Tezgahı C-25.408



Demonte Çalışma Tezgahı C-25.410

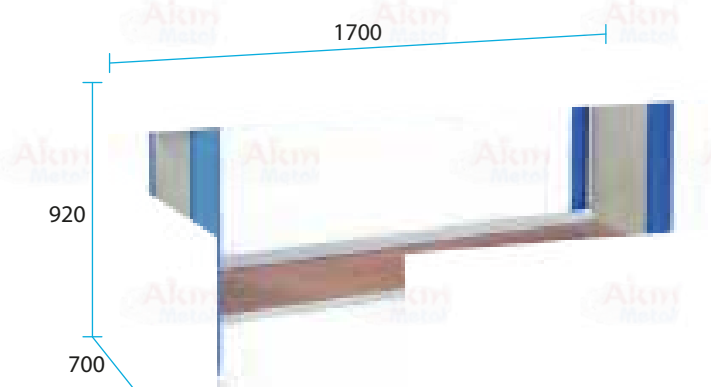

Takım Arabası D-30.102

Çekmece Adet ve Ölçüsü : 4 x 100 + 1 x 205 mm



Takım Arabası D-30.104

Çekmece Adet ve Ölçüsü : 6 x 75 + 1 x 150 mm



Takım Arabası D-30.106

Çekmece Adet ve Ölçüsü : 1 x 100 + 2 x 150 + 1 x 205 mm



Takım Arabası D-30.108

Çekmece Adet ve Ölçüsü : 4 x 100 + 1 x 205 mm



Takım Arabası D-30.110

Çekmece Adet ve Ölçüsü : 5 x 100 + 1 x 205 mm



Takım Arabası D-30.112

Çekmece Adet ve Ölçüsü : 7 x 100 + 1 x 180mm



Takım Arabası D-30.114

Çekmece Adet ve Ölçüsü : 7 x 100 + 1 x 205 mm



Takım Arabası D-30.116

Çekmece Adet ve Ölçüsü : 6 x 90 + 1 x 190 mm



Takım Arabası D-30.118

Çekmece Adet ve Ölçüsü : 3 x 100 + 1 x 205 mm



Takım Arabası D-30.120

Çekmece Adet ve Ölçüsü : 4 x 100 mm



Takım Arabası D-30.122

Çekmece Adet ve Ölçüsü : 2 x 100 + 1 x 205 mm



Takım Arabası D-30.124

Çekmece Adet ve Ölçüsü : 1 x 100 mm



Takım Arabası D-30.126

Çekmece Adet ve Ölçüsü : 1 x 100 mm



Takım Arabası D-30.128

Çekmece Adet ve Ölçüsü : 1 x 100 mm



Takım Arabası D-30.130



Takım Arabası D-30.132

Çekmece Adet ve Ölçüsü : 1 x 100 mm



Takım Arabası D-30.134

Çekmece Adet ve Ölçüsü : 7 x 75 + 1 x 170 mm



Takım Arabası D-30.136

Çekmece Adet ve Ölçüsü : 5 x 100 + 1 x 205 mm



Takım Arabası D-30.138

Çekmece Adet ve Ölçüsü : 3 x 100 + 1 x 300 mm



Takım Arabası D-30.140

Çekmece Adet ve Ölçüsü : 3 x 75 + 1 x 205 mm



Takım Arabası D-30.142

Çekmece Adet ve Ölçüsü : 3 x 100 + 1 x 205 mm



Takım Arabası D-30.144

Çekmece Adet ve Ölçüsü : 7 x 100 + 1 x 150 mm



Takım Arabası D-30.146

Çekmece Adet ve Ölçüsü : 4 x 100 + 2 x 205 mm



Takım Arabası D-30.148

Çekmece Adet ve Ölçüsü : 4 x 100 + 1 x 205 mm



Takım Arabası D-30.202

Çekmece Adet ve Ölçüsü : 4 x 100 + 1 x 205 mm



Takım Arabası D-30.204

Çekmece Adet ve Ölçüsü : 4 x 100 + 1 x 205 mm



Takım Arabası D-30.206

Çekmece Adet ve Ölçüsü : 1 x 100 + 2 x 150 + 1 x 205 mm



Takım Arabası D-30.208

Çekmece Adet ve Ölçüsü : 1 x 100 + 2 x 150 + 1 x 205 mm



Takım Arabası D-30.210

Çekmece Adet ve Ölçüsü : 1 x 100 + 2 x 150 + 1 x 205 mm



Takım Arabası D-30.302

Çekmece Adet ve Ölçüsü : 2 x 100 mm



Takım Arabası D-30.304

Çekmece Adet ve Ölçüsü : 1 x 100 mm

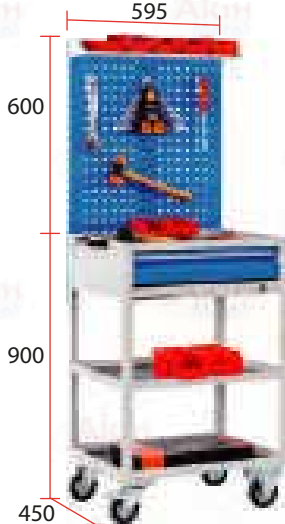

Takım Arabası D-30.306

Çekmece Adet ve Ölçüsü : 4 x 100 + 1 x 205 mm



Takım Arabası D-30.308

Çekmece Adet ve Ölçüsü : 1 x 100 mm

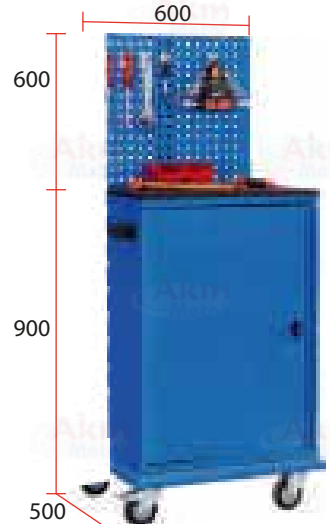



PROFESYONELLERİN TERCİHİ TERCİHİ



Takım Arabası D-30.310

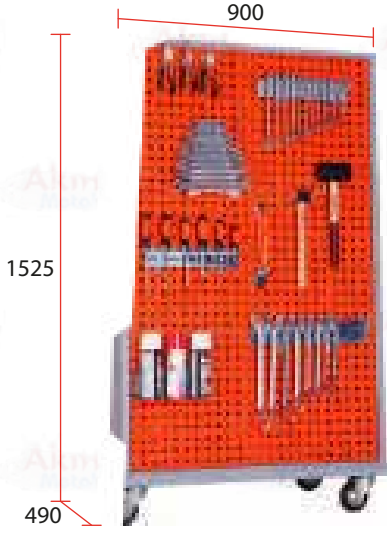

Takım Arabası D-30.312



Takım Arabası D-30.314

Çekmece Adet ve Ölçüsü : 1 x 100 mm

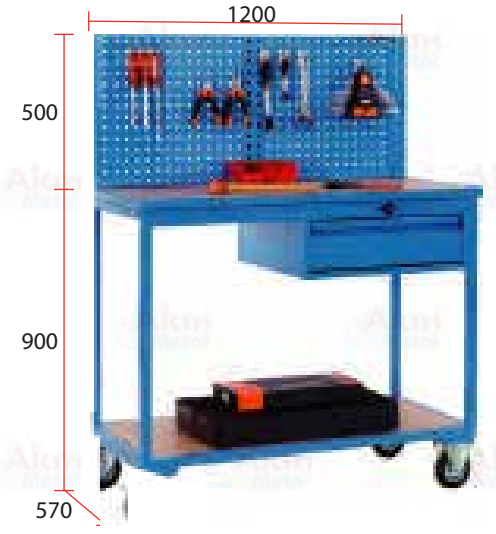

Takım Arabası D-30.402

Çekmece Adet ve Ölçüsü : 4 x 100 + 1 x 205 mm

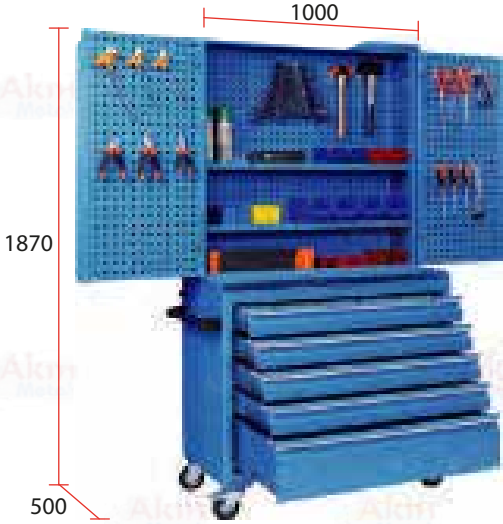

Takım Arabası D-30.404

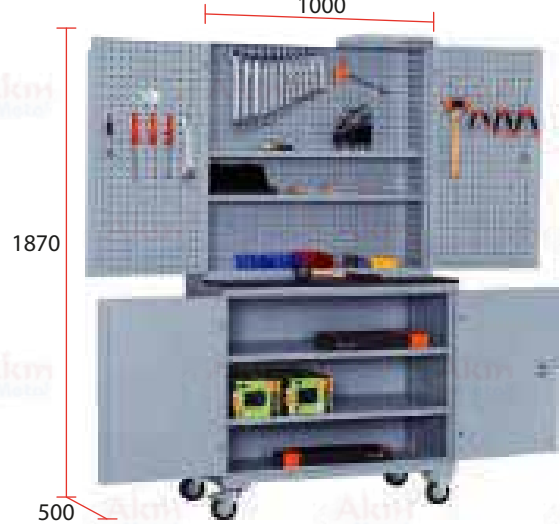

Takım Arabası D-30.502

Çekmece Adet ve Ölçüsü : 4 x 100 + 1 x 205 mm



Takım Arabası D-30.604

Çekmece Adet ve Ölçüsü : 10 x 100 + 2 x 205 mm





SINIRSIZ UYGULAMA ALANLARI



10 Çekmeceli Kes50.G02



9 Çekmeceli Kes50.G04



8 Çekmeceli Kes50.G06



7 Çekmeceli Kes50.G08



7 Çekmeceli Kes50.G10



7 Çekmeceli Kes50.G12



6 Çekmeceli Kes50.G14



5 Çekmeceli Kes50.G16

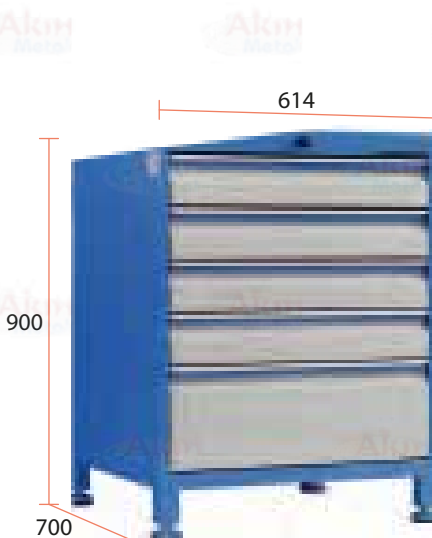

10 Çekmeceli Kes50.G24



Mors Tutucu Dolap B5 E02



Mors Tutucu Dolap B5 E04



Mors Tutucu Dolap B5 E06



Mors Tutucu Dolap B5 E08



Mors Tutucu Dolap R5 E-2



Mors Tutucu Raflı R5 E-30

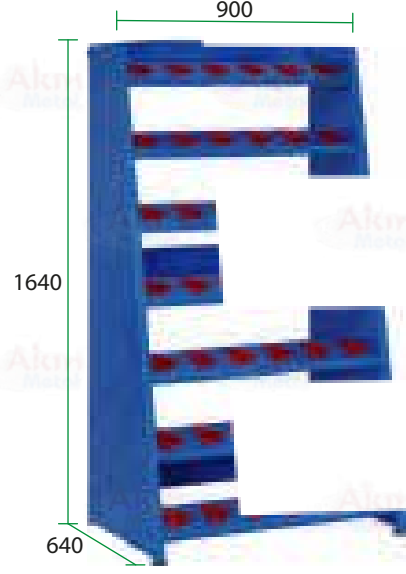

Mors Tutucu Raflı R5 E-32

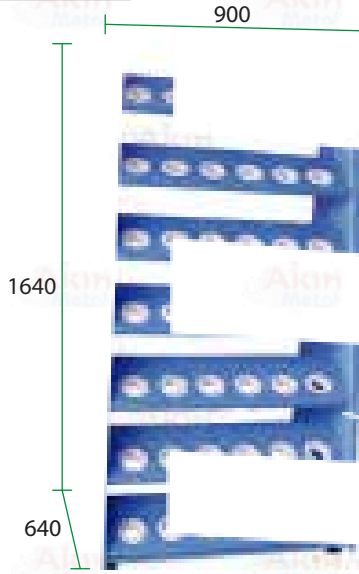

Mors Tutucu Araba R5 E-40



Mors Tutucu Araba R5 E-42



Mors Tutucu Araba R5 E-44





SİZ HAYAL EDİN BİZ ÜRETELİM RETELİM



Mors Tutucu Arabası E46



Mors Tutucu Arabası E48

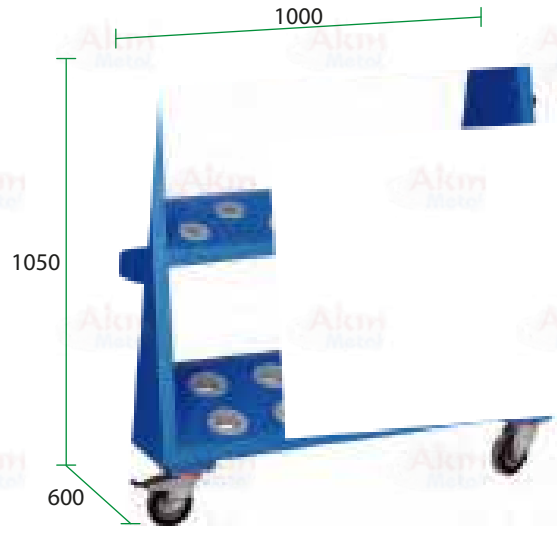

Mors Tutucu Arabası E50



Mors Tutucu Arabası E52



Mors Tutucu Şeşesi E60

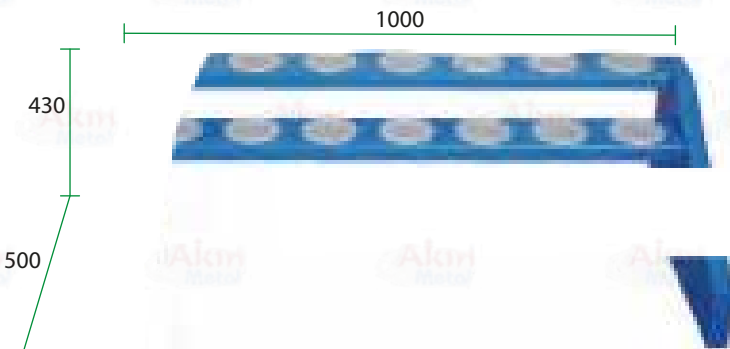

Mors Tutucu Şeşesi E62

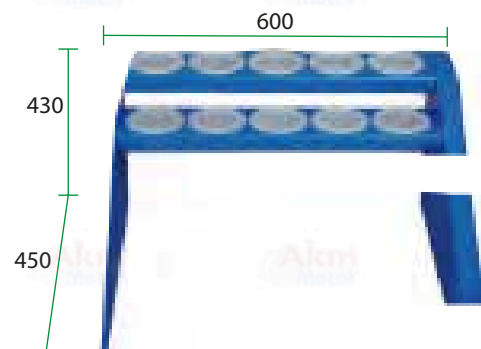

Malzeme Dolabı F-40.102



Malzeme Dolabı F-40.104



Malzeme Dolabı F-40.106



Malzeme Dolabı F-40.108



Malzeme Dolabı F-40.110



Malzeme Dolabı F-40.152



Malzeme Dolabı F-40.154



Malzeme Dolabı F-40.156



Malzeme Dolabı F-40.170



Malzeme Dolabı F-40.172



Malzeme Dolabı F-40.174



Malzeme Dolabı F-40.176



Malzeme Dolabı F-40.178

Malzeme Dolabı F-40.180



Malzeme Dolabı F-40.182

Malzeme Dolabı F-40.202



Malzeme Dolabı F-40.204



Malzeme Dolabı F-40.252



Klasör Dolabı F-40.302



Malzeme Dolabı F-40.304



Klasör Dolabı F-40.306



Ecza Dolabı F-40.402



Kimyasal Malzeme Dolabı F-42.102



Kimyasal Malzeme Dolabı F-42.104





ÇÖZÜM ORTAĞINIZ



Yangına Dayanıklı Malzeme Dolabı F-45.102



Yangına Dayanıklı Malzeme Dolabı F-45.104



Askılı Dosya Dolabı F-48.102



Askılı Dosya Dolabı F-48.104



Operatör Dolabı 0-85.102



Operatör Dolabı 0-85.104



Operatör Dolabı 0-85.116



Operatör Dolabı 0-85.118



Bilgisayar Dolabı 0-85.124



Bilgisayar Dolabı 0-85.126



Bilgisayar Dolabı 0-85.128



Bilgisayar Dolabı 0-85.130



Bilgisayar Dolabı 0-85.132



Operatör Dolabı 0-85.164



Operatör Dolabı 0-85.166



Operatör Dolabı 0-85.168



Temizlik Dolabı H-55.102



Soyunma Dolabı H-55.104



Soyunma Dolabı H-55.106



Soyunma Dolabı H-55.108



Soyunma Dolabı H-55.110



Soyunma Dolabı H-55.112



Soyunma Dolabı H-55.114



Emanet Dolabı H-55.116

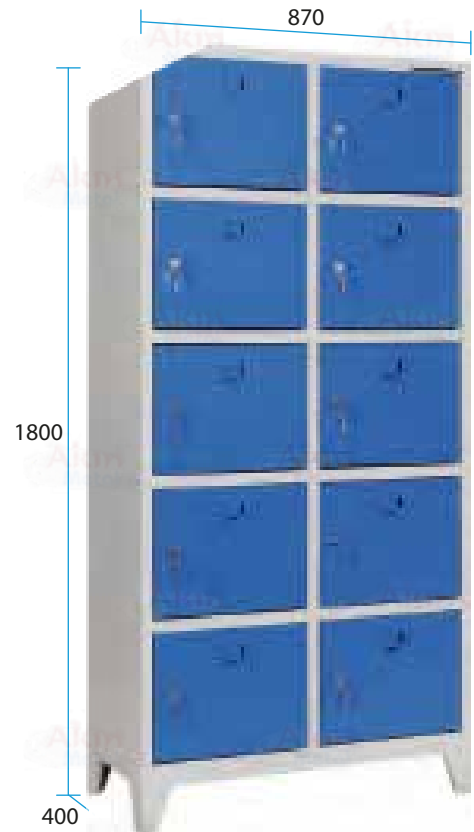

Paket Taşıma Arabası K-60.102

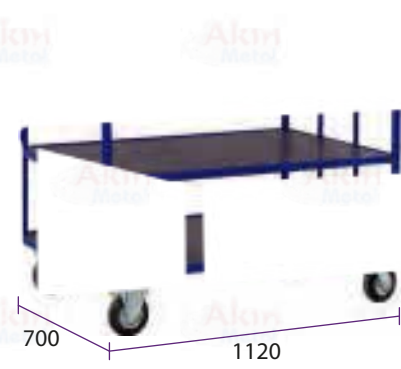

Paket Taşıma Arabası K-60.104

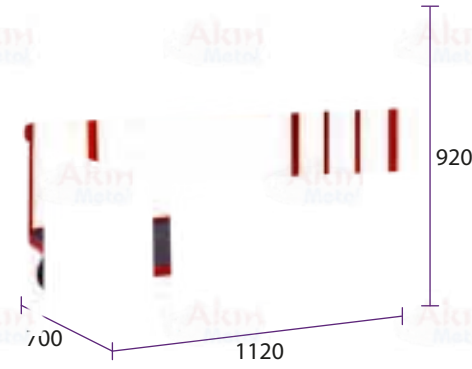

Paket Taşıma Arabası K-60.106

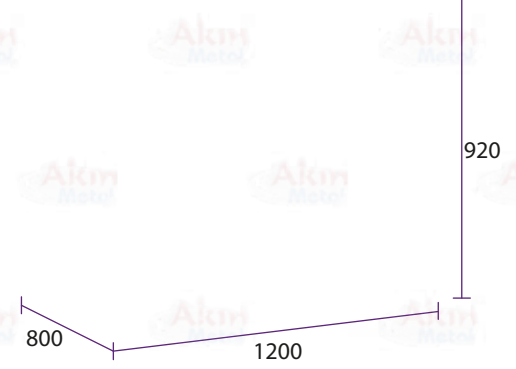

Paket Taşıma Arabası K-60.108

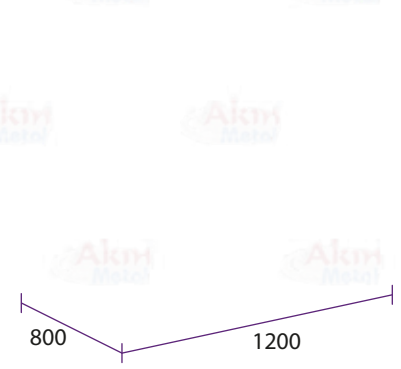

Paket Taşıma Arabası K-60.110

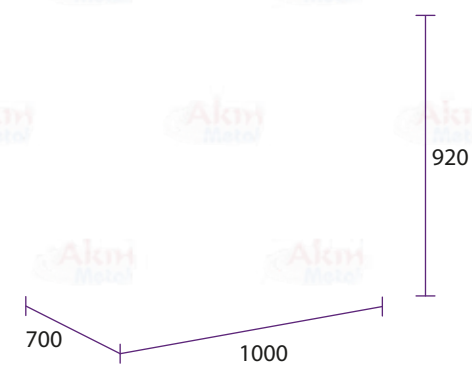

Paket Taşıma Arabası K-60.112

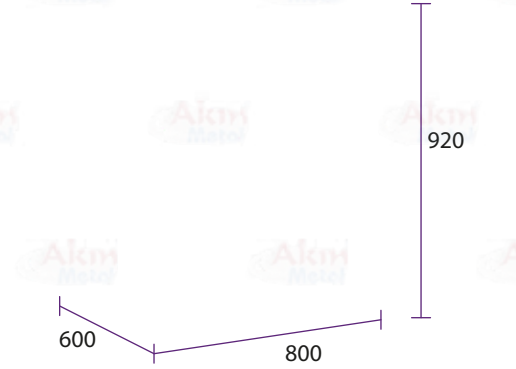

Paket Taşıma Arabası K-60.114

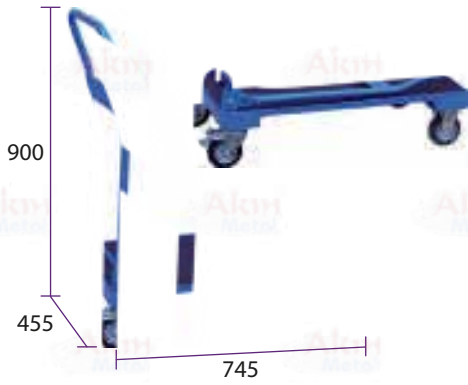

Paket Taşıma Arabası K-60.116

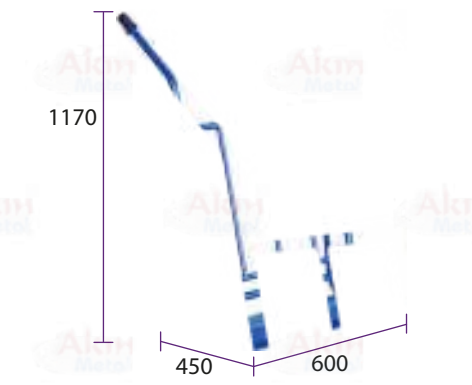

Paket Taşıma Arabası K-60.117

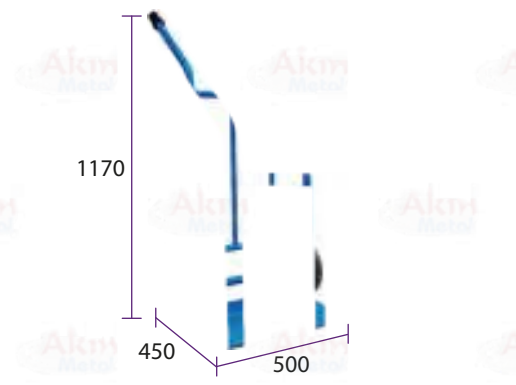

Paket Taşıma Arabası K-60.118



Tüp Taşıma Arabası K-60.120

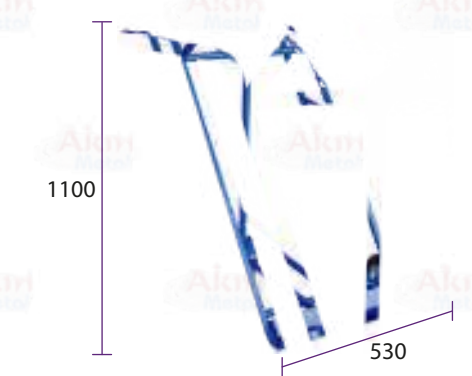

Tüp Taşıma Arabası K-60.122

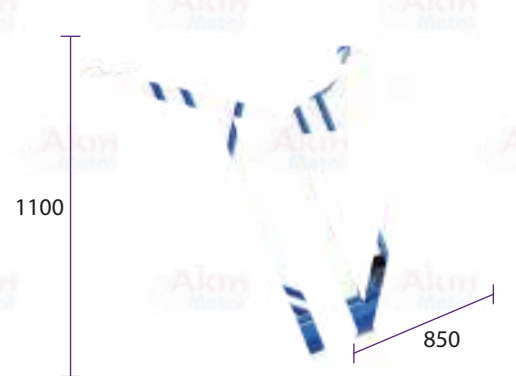

Tüp Taşıma Arabası K-60.128

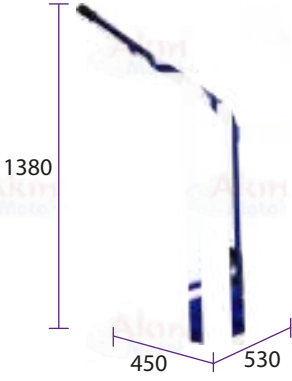

Tüp Taşıma Arabası K-60.130

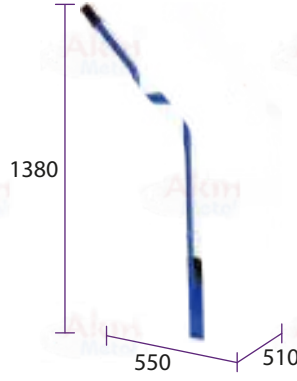

Tüp Bağlantısı K-60.132

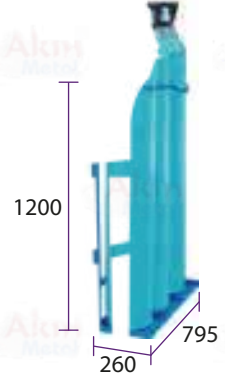

Tüp Bağlantısı K-60.134

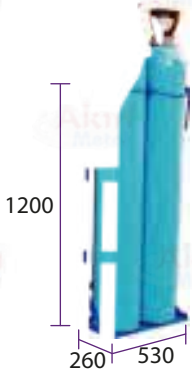

Varil Taşıma Arabası K-60.140

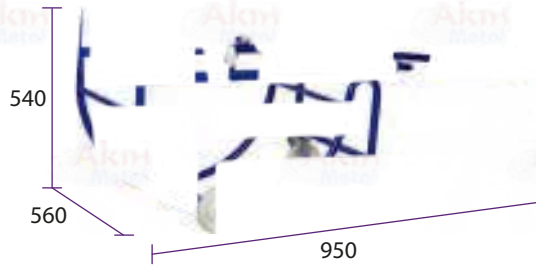

Varil Taşıma Arabası K-60.144

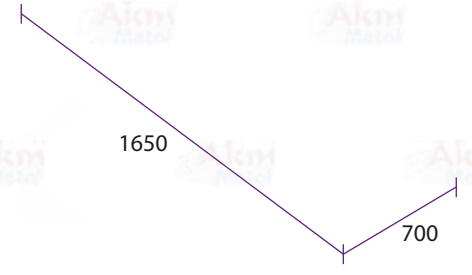

Varil Taşıma Arabası K-60.146

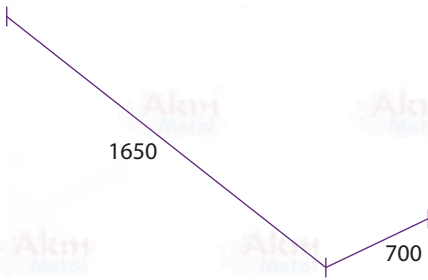

Motor Toplama Sehpası K-60.150

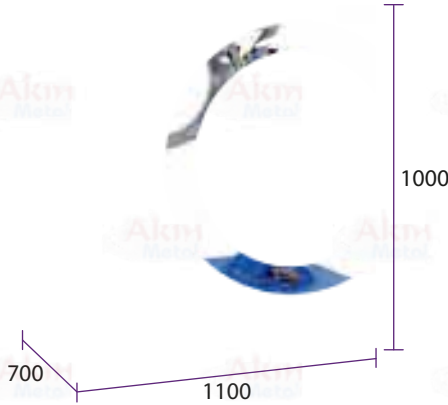

Motor Taşıma Arabası K-



Paket Taşıma Arabası K-60.160

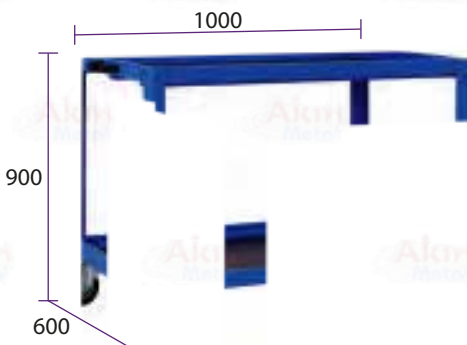

Paket Taşıma Arabası K-60.162



Damacana Taşıma Arabası K-60.180



Dönerli Dolap P-18



Dönerli Dolap P-20

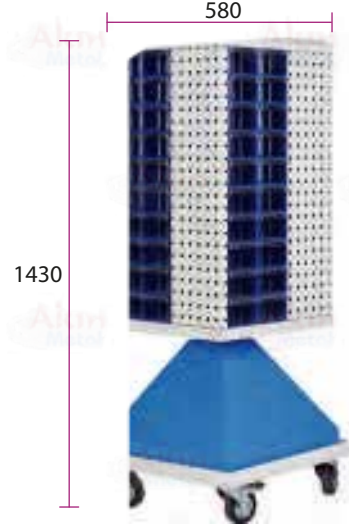

Avadanlık Standı P-90.122

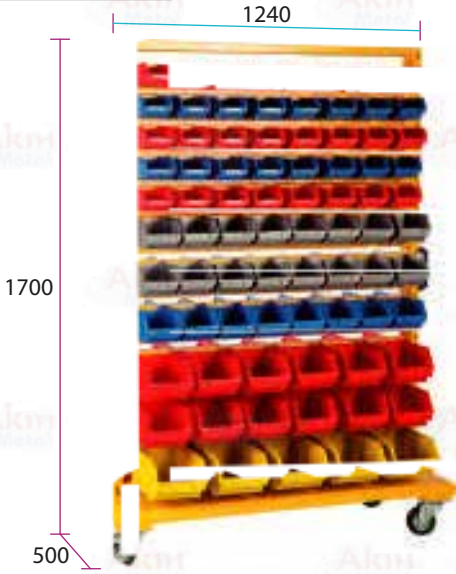

Avadanlık Standı P-90.124

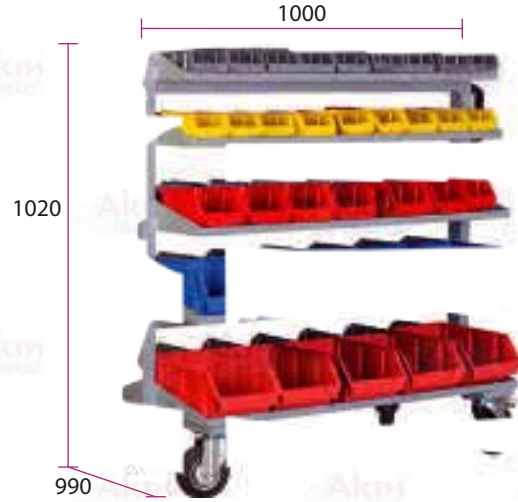

Avadanlık Standı P-90.126



Avadanlık Standı P-90.128



Avadanlık Standı P-90.130

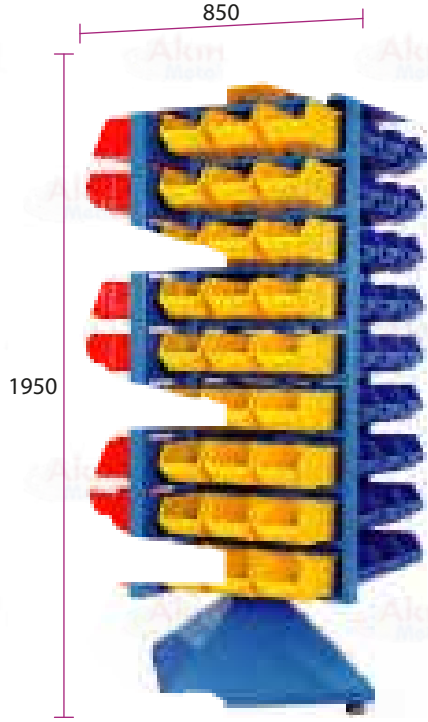

Avadanlık Dolabı P-90.158



Avadanlık Dolabı P-90.160

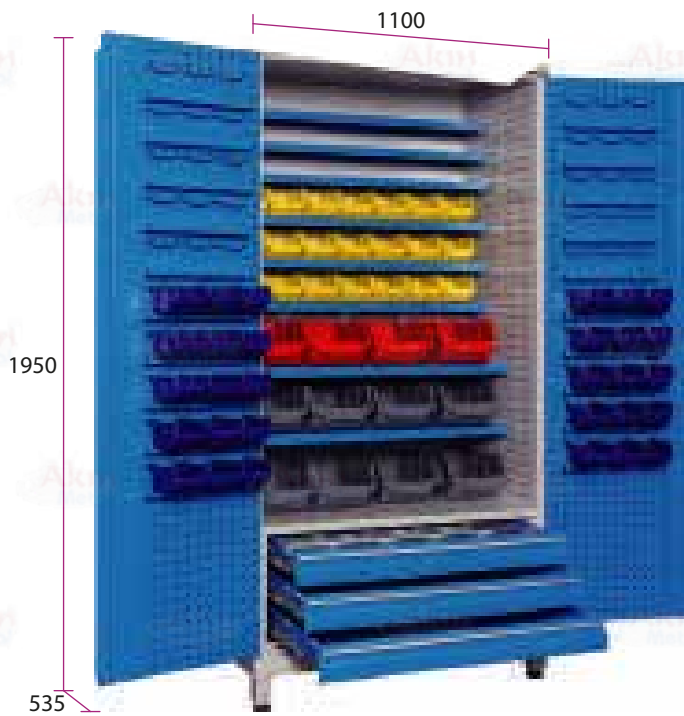

Kutu Standı P-90.350

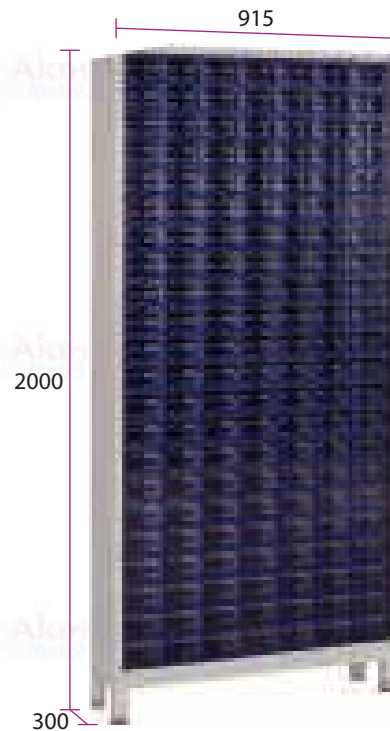

Ağır Raf Ünitesi L-65.102

Hafif Raf Ünitesi L-65.104

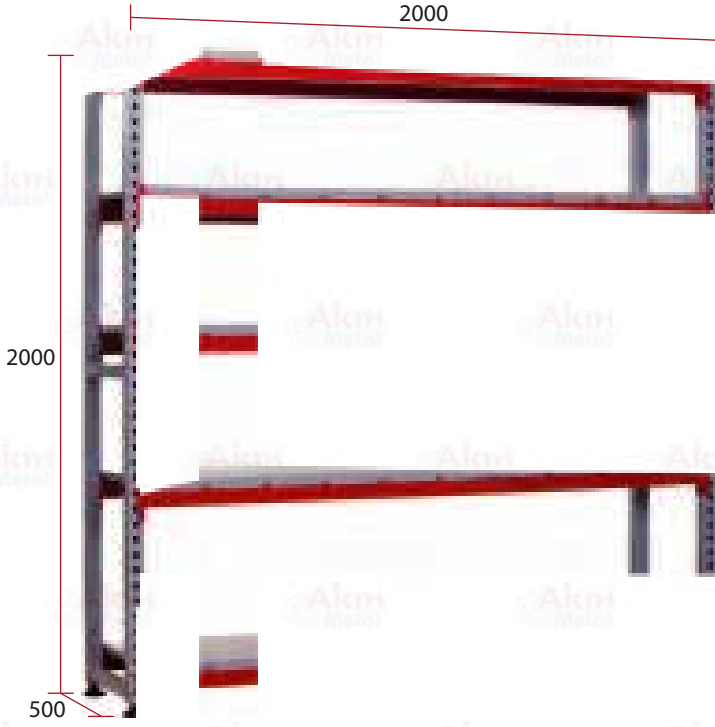

Hafif Raf Ünitesi L-65.106

Hafif Raf Ünitesi L-65.108

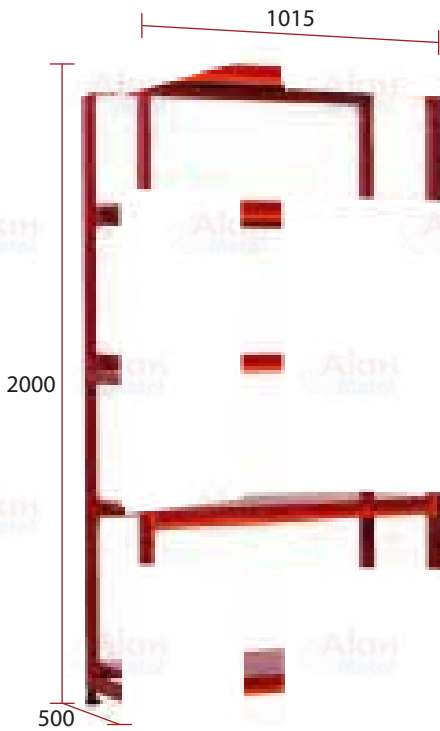

Çekmeceli Raf Ünitesi L-65.110



Varil Sehpaı L-65.112

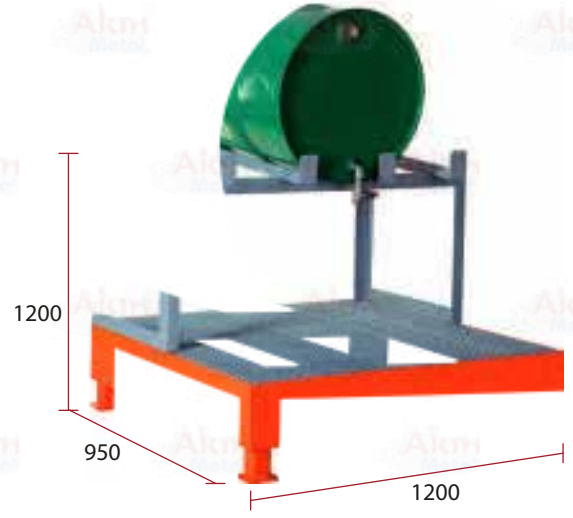

Varil Sehpaı L-65.114

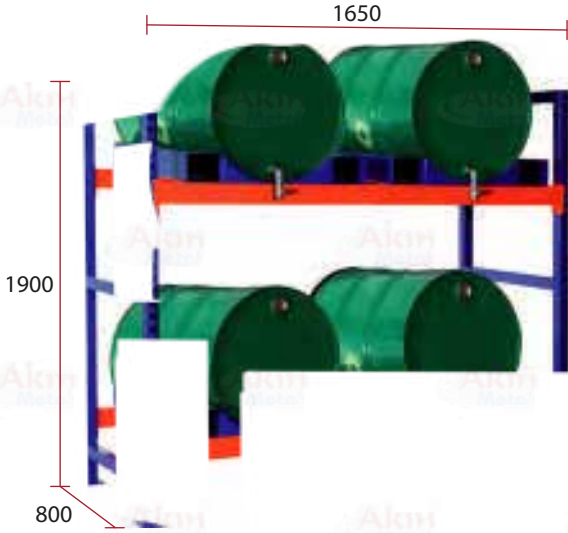

Varil Sehpaı L-65.115

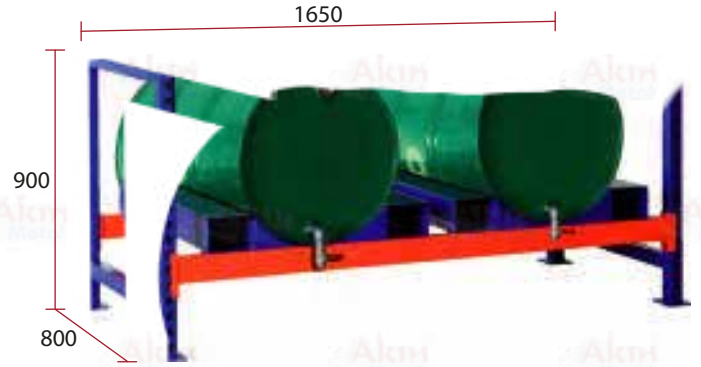

Lastik İstifleme Rafı L-65.116

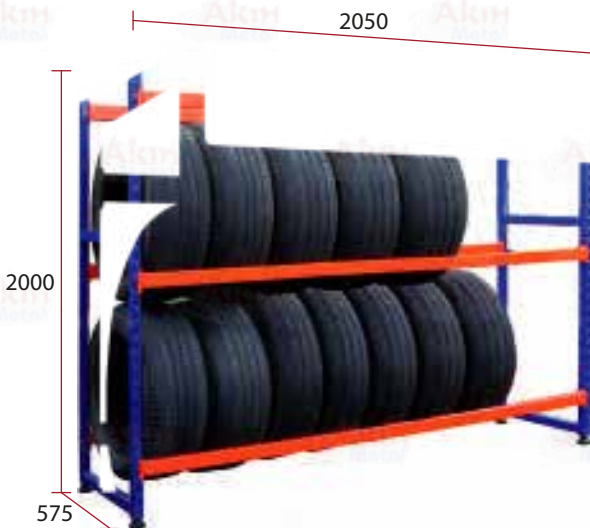

Konsol Kollu Stok Rafı L-65.118

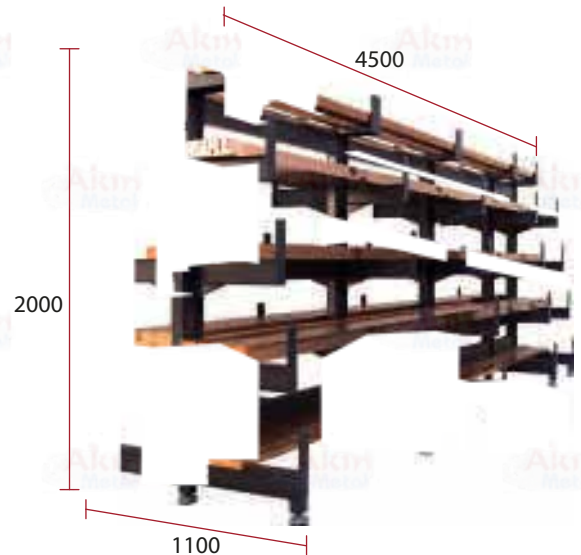

Konsol Kollu Stok Rafı L-65.120

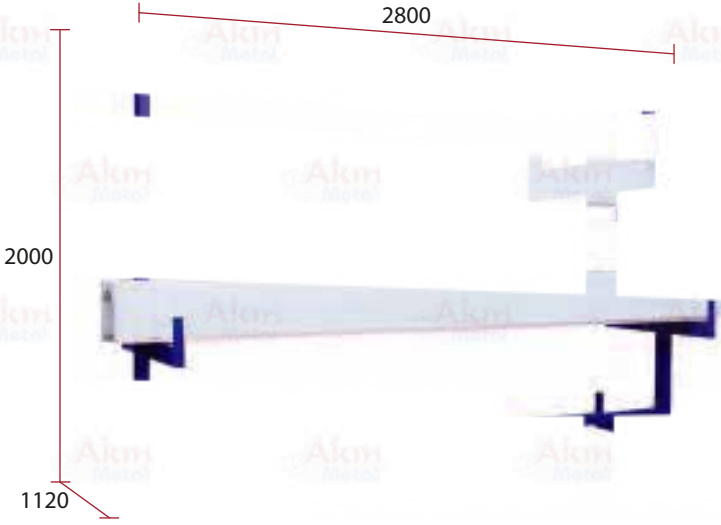

Fittings Stok Rafı L65.144

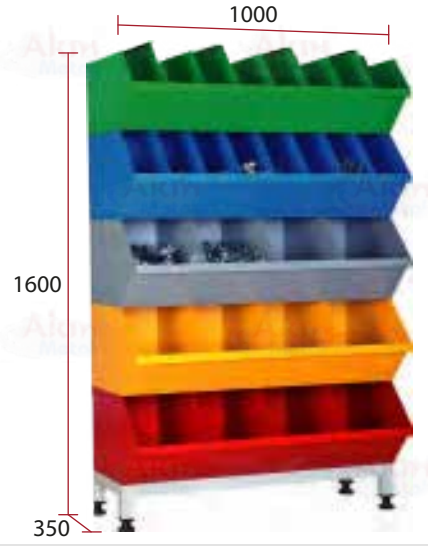

Fittings Stok Rafı L-65.146

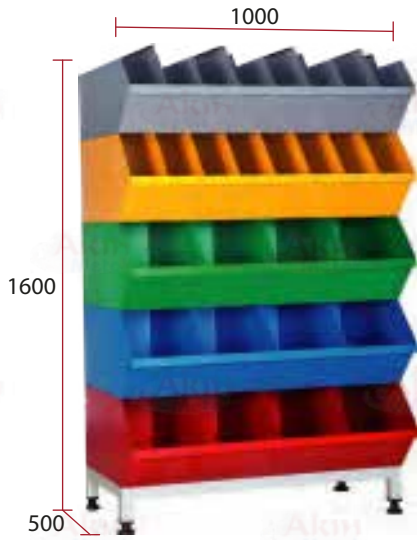

Fittings Stok Rafı L-65.148

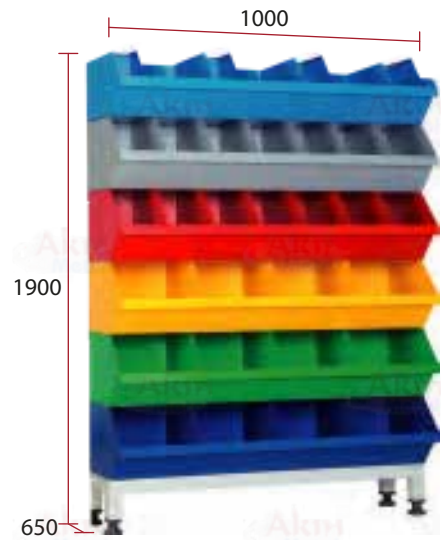

Malzeme Rafı L-65.202

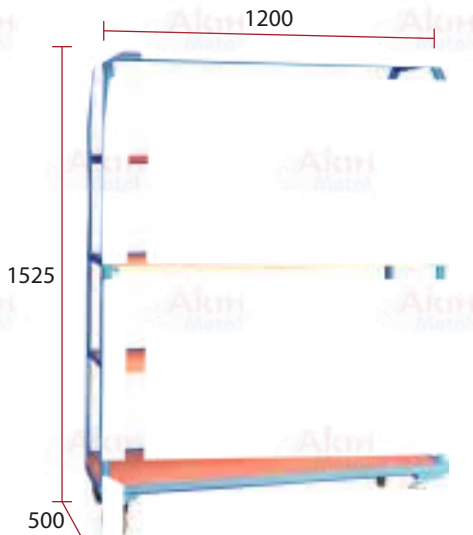

Malzeme Rafı L-65.204

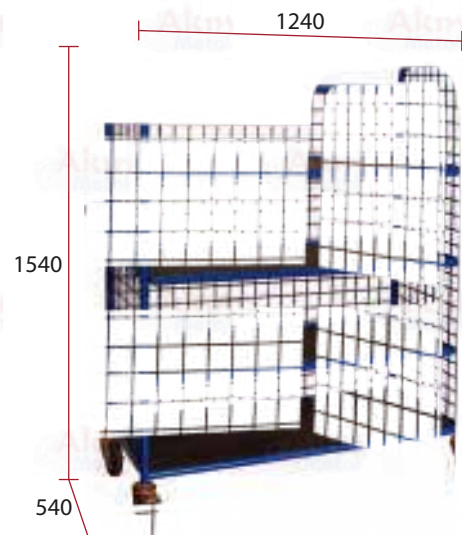

Teşhir Standı L-65.208

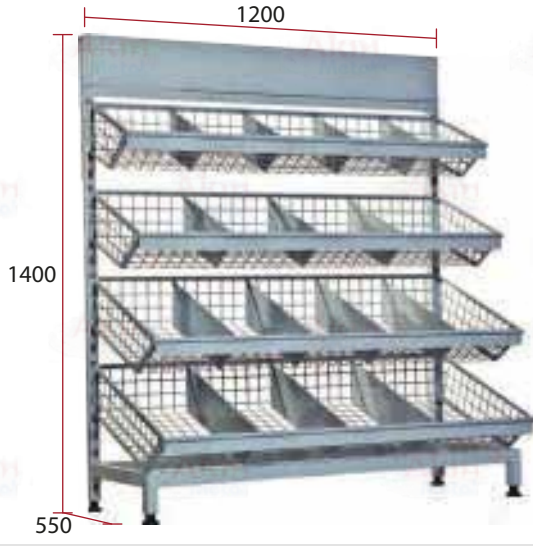

Malzeme Sepeti L-65.210



Teşhir Standı L-65.214

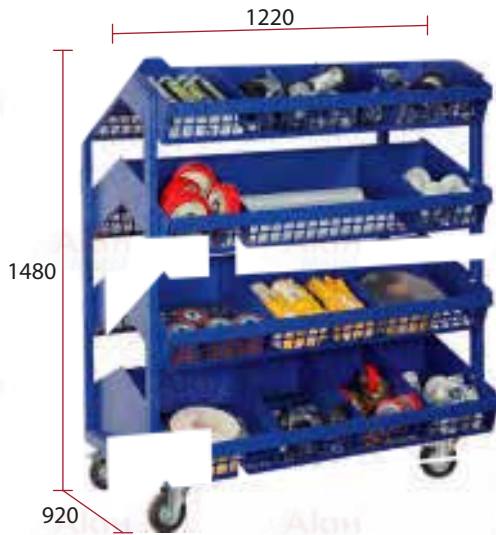

Teşhir Standı L-65.252



Teşhir Standı L-65.254



Teşhir Standı L-65.256

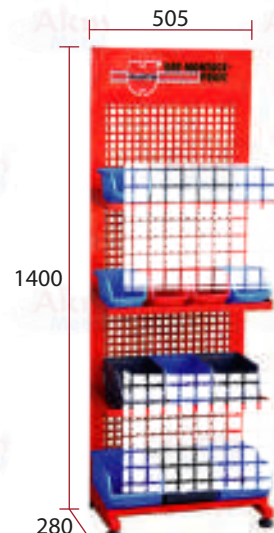

Merdiven M-134

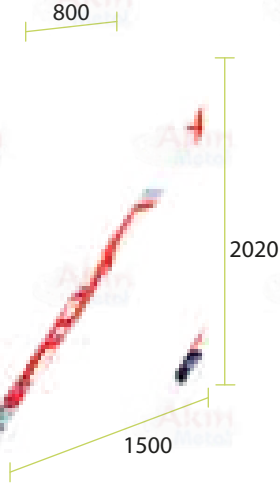

Malzeme Taşıma Sehpası M-75.144



Talaş Konteyniri M-75.160

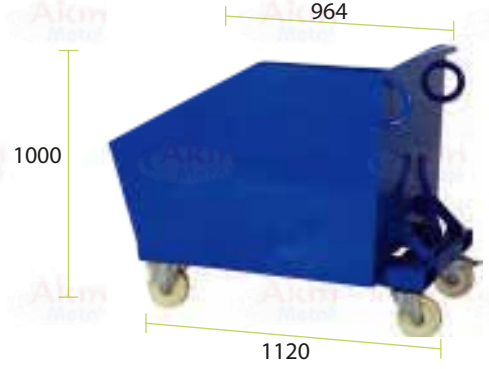

Talaş Konteyniri M-75.162



Takım Asma Panosu M-75.174



Anahtarlık Dolabı M-75.176



Çalışma Masası M-75.302



Çalışma Masası M-75.304

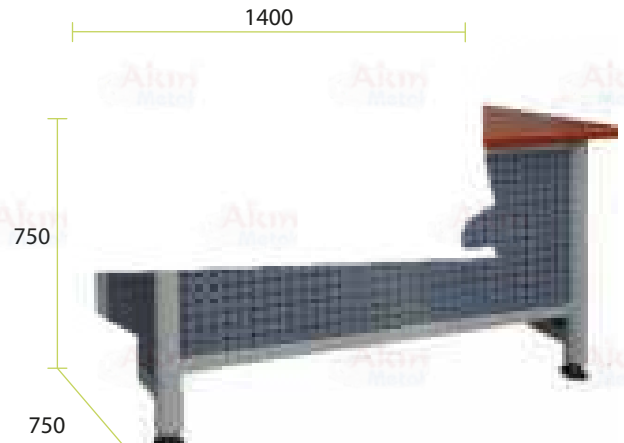

TEZGAH ÜSTÜ ÇALIŞMA ALANI YÜZEYLERİ

30 mm MDF



25 mm Sunta Üzeri 4 mm Paslanmaz



25 mm Sunta Üzeri 2 mm Paslanmaz (Havuzlu)



25 mm Sunta Üzeri Laminant Kaplama



25 mm Su Kontrastı



25 mm Su Kontrastı Üzeri 5 mm Kauçuk



25 mm Su Kontrastı Üzeri 2 mm PVC

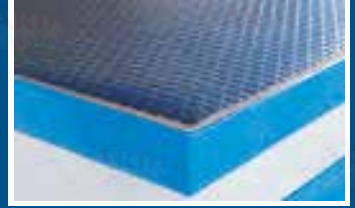

Koruma Kabin75/202



Koruma Kabin75/204



Koruma Kabin75/206



Koruma Kabin75/208



Koruma Kabin75/210





Tüm modellerimiz hakkında detaylı bilgi için
Web Sitemizi veya **Profesyonel Araç İçi Donanımları**
katalogunu inceleyebilirsiniz.

Bakım Onarım Aracı MrS-61158

Bakım Onarım Aracı MrS-61144



Bakım Onarım Aracı ID-61152

Bakım Onarım Aracı FrT-61160



Bakım Onarım Aracı MrS-61162

Bakım Onarım Aracı MrS-61136



Bakım Onarım Aracı HD-61152

Bakım Onarım Aracı MrS-61145



Bakım Onarım Aracı MV-71042



Bakım Onarım Aracı VT-71028



Bakım Onarım Aracı FrC-81050



Bakım Onarım Aracı VC-81058



Tornavida Asma Aparatı - 030



Düz Anahtar Asma Aparatı - 031



Düz-Yıldız Anahtar Asma Aparatı - 032



Yıldız Anahtar Asma Aparatı - 033



Allen Asma Aparatı - 034



Matkaplık - 035



2'li Avadanlık - 036



Klipsli Kanca - 037



Kablo Sarma Aparatı - 038



Broşürlük - 039



3'lü Spreylik - 040



1'li Spreylik - 041



Çiftli Uzun Dar Kanca - 042



Çiftli Kısa Geniş Kanca - 043



Çiftli Uzun Geniş Kanca - 044



Kare Uzun Kanca - 045



Kare Kısa Kanca - 046



Çap 70 mm Kanca - 047



Çap 50 mm Kanca - 048



Çap 35 mm Kanca - 049



Tekli 150 mm Kanca - 050



Tekli 85 mm Kanca - 051



Tekli 55 mm Kanca - 052



Tekli 35 mm Kanca - 053



MUHTELİF PANO ÖLÇÜLERİ

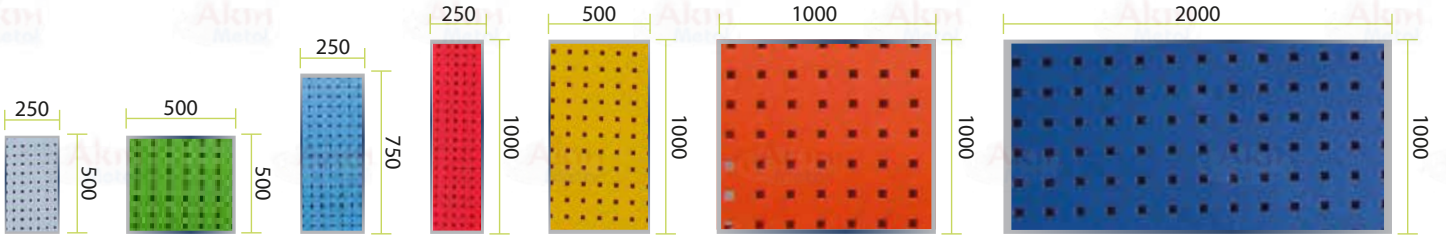

RAL RENK KARTELASI

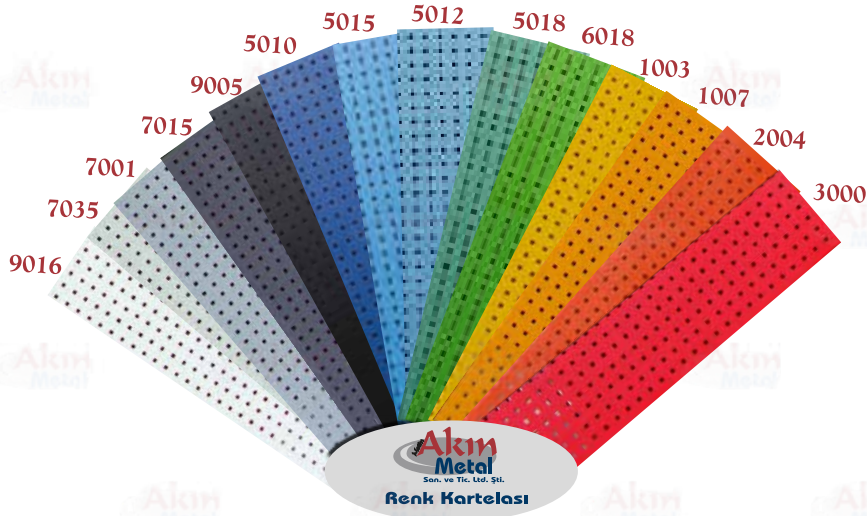

SERTİFİKALARIMIZ





ÇÖZÜM ORTAĞINIZ





Akın[®]
Metal